

# **Data-Over-Cable Service Interface Specifications DOCSIS® 3.1**

## **CCAP™ Operations Support System Interface Specification**

**CM-SP-CCAP-OSSv3.1-I08-170111**

**ISSUED**

### **Notice**

This DOCSIS specification is the result of a cooperative effort undertaken at the direction of Cable Television Laboratories, Inc. for the benefit of the cable industry and its customers. You may download, copy, distribute, and reference the documents herein only for the purpose of developing products or services in accordance with such documents, and educational use. Except as granted by CableLabs® in a separate written license agreement, no license is granted to modify the documents herein (except via the Engineering Change process), or to use, copy, modify or distribute the documents for any other purpose.

This document may contain references to other documents not owned or controlled by CableLabs®. Use and understanding of this document may require access to such other documents. Designing, manufacturing, distributing, using, selling, or servicing products, or providing services, based on this document may require intellectual property licenses from third parties for technology referenced in this document. To the extent this document contains or refers to documents of third parties, you agree to abide by the terms of any licenses associated with such third-party documents, including open source licenses, if any.

© Cable Television Laboratories, Inc. 2014-2017

## DISCLAIMER

This document is furnished on an "AS IS" basis and neither CableLabs nor its members provides any representation or warranty, express or implied, regarding the accuracy, completeness, noninfringement, or fitness for a particular purpose of this document, or any document referenced herein. Any use or reliance on the information or opinion in this document is at the risk of the user, and CableLabs and its members shall not be liable for any damage or injury incurred by any person arising out of the completeness, accuracy, or utility of any information or opinion contained in the document.

CableLabs reserves the right to revise this document for any reason including, but not limited to, changes in laws, regulations, or standards promulgated by various entities, technology advances, or changes in equipment design, manufacturing techniques, or operating procedures described, or referred to, herein.

This document is not to be construed to suggest that any company modify or change any of its products or procedures, nor does this document represent a commitment by CableLabs or any of its members to purchase any product whether or not it meets the characteristics described in the document. Unless granted in a separate written agreement from CableLabs, nothing contained herein shall be construed to confer any license or right to any intellectual property. This document is not to be construed as an endorsement of any product or company or as the adoption or promulgation of any guidelines, standards, or recommendations.

## Document Status Sheet

<b>Document Control Number:</b>	CM-SP-CCAP-OSSlv3.1-I08-170111			
<b>Document Title:</b>	CCAP™ Operations Support System Interface Specification			
<b>Revision History:</b>	I01 - Released 08/08/2014 I02 - Released 11/20/2014 I03 - Released 03/26/2015 I04 - Released 06/11/2015 I05 - Released 09/10/2015 I06 - Released 12/10/2015 I07 - Released 06/02/2016 I08 - Released 01/11/2017			
<b>Date:</b>	January 11, 2017			
<b>Status:</b>	<del>Work in Progress</del>	<del>Draft</del>	<b>Issued</b>	<del>Closed</del>
<b>Distribution Restrictions:</b>	<del>Author Only</del>	<del>CL/Member</del>	<del>CL/Member/ Vendor</del>	<b>Public</b>

### Key to Document Status Codes

- Work in Progress** An incomplete document, designed to guide discussion and generate feedback that may include several alternative requirements for consideration.
- Draft** A document in specification format considered largely complete, but lacking review by Members and vendors. Drafts are susceptible to substantial change during the review process.
- Issued** A generally public document that has undergone Member and Technology Supplier review, cross-vendor interoperability, and is for Certification testing if applicable. Issued Specifications are subject to the Engineering Change Process.
- Closed** A static document, reviewed, tested, validated, and closed to further engineering change requests to the specification through CableLabs.

### Trademarks

CableLabs® is a registered trademark of Cable Television Laboratories, Inc. Other CableLabs marks are listed at <http://www.cablelabs.com/certqual/trademarks>. All other marks are the property of their respective owners.

# Contents

<b>1</b>	<b>SCOPE.....</b>	<b>25</b>
1.1	Introduction and Purpose.....	25
1.2	Background.....	25
1.2.1	<i>Broadband Access Network</i> .....	25
1.2.2	<i>Network and System Architecture</i> .....	26
1.2.3	<i>Service Goals</i> .....	28
1.2.4	<i>Statement of Compatibility</i> .....	28
1.2.5	<i>DOCSIS 3.1 Documents</i> .....	29
1.3	Requirements.....	29
1.4	Conventions.....	29
1.5	Organization of Document.....	30
1.5.1	<i>Annexes (Normative)</i> .....	30
1.5.2	<i>Appendices (Informative)</i> .....	30
<b>2</b>	<b>REFERENCES .....</b>	<b>32</b>
2.1	Normative References.....	32
2.2	Informative References.....	38
2.3	Reference Acquisition.....	40
<b>3</b>	<b>TERMS AND DEFINITIONS .....</b>	<b>41</b>
<b>4</b>	<b>ABBREVIATIONS, ACRONYMS, AND NAMESPACES .....</b>	<b>44</b>
4.1	XML Namespaces .....	50
<b>5</b>	<b>OVERVIEW.....</b>	<b>52</b>
5.1	FCAPS Network Management Model.....	52
5.1.1	<i>Fault Management</i> .....	52
5.1.2	<i>Configuration Management</i> .....	54
5.1.3	<i>Accounting Management</i> .....	55
5.1.4	<i>Performance Management</i> .....	55
5.1.5	<i>Security Management</i> .....	55
5.2	Management Architectural Overview.....	55
5.3	DOCSIS 3.1 OSSI Key Features .....	56
5.3.1	<i>Fault Management Features</i> .....	57
5.3.2	<i>Configuration Management Features</i> .....	57
5.3.3	<i>Performance Management Features</i> .....	57
5.4	Information Models .....	57
<b>6</b>	<b>CONFIGURATION MANAGEMENT .....</b>	<b>59</b>
6.1	CCAP Configuration Theory of Operation.....	59
6.2	CCAP Configuration and Transport Protocol Requirements.....	59
6.2.1	<i>Configuration Object Datastore</i> .....	59
6.2.2	<i>DHCP Relay Agent Requirements</i> .....	60
6.2.3	<i>Dynamic Management of QAMs</i> .....	60
6.2.4	<i>Video Configuration Requirements</i> .....	60
6.2.5	<i>DOCSIS Configuration Requirements</i> .....	60
6.3	CCAP XML File-Based Configuration .....	61
6.3.1	<i>CCAP XML Configuration File Theory of Operation</i> .....	61
6.3.2	<i>CCAP XML Configuration Files</i> .....	61
6.3.3	<i>XML Configuration File Checksum</i> .....	62
6.3.4	<i>XML Configuration File Validation</i> .....	62
6.3.5	<i>XML Configuration File Execution Command and NETCONF Operations</i> .....	63
6.3.6	<i>XML Configuration File Parsing and Error Logging</i> .....	66



6.3.7	<i>File Transfer Mechanisms</i> .....	67
6.3.8	<i>Exporting the Configuration Object Data Store</i> .....	68
6.4	CCAP NETCONF-Based Configuration .....	69
6.4.1	<i>NETCONF Theory of Operation</i> .....	69
6.4.2	<i>NETCONF Overview</i> .....	69
6.4.3	<i>NETCONF Requirements</i> .....	70
6.5	CCAP Data Type Definitions .....	70
6.5.1	<i>AdminState</i> .....	73
6.5.2	<i>AttrAggrRuleMask</i> .....	73
6.5.3	<i>AttributeMask</i> .....	73
6.5.4	<i>BitRate</i> .....	73
6.5.5	<i>ChannelList</i> .....	74
6.5.6	<i>ChChgInitTechMap</i> .....	74
6.5.7	<i>ChId</i> .....	74
6.5.8	<i>ChSetId</i> .....	74
6.5.9	<i>CmtsCmRegState</i> .....	75
6.5.10	<i>Dsid</i> .....	76
6.5.11	<i>DsOfdmCyclicPrefixType</i> .....	77
6.5.12	<i>DsOfdmModulationType</i> .....	77
6.5.13	<i>DsOfdmSubcarrierSpacingType</i> .....	77
6.5.14	<i>DsOfdmWindowingType</i> .....	77
6.5.15	<i>HePidValue</i> .....	77
6.5.16	<i>Host</i> .....	77
6.5.17	<i>HundredthdB</i> .....	77
6.5.18	<i>ifDirection</i> .....	77
6.5.19	<i>IpAddress</i> .....	78
6.5.20	<i>InetAddressPrefixLength</i> .....	78
6.5.21	<i>InetIpPrefix</i> .....	78
6.5.22	<i>InetIpv4Prefix</i> .....	78
6.5.23	<i>InetIpv6Prefix</i> .....	78
6.5.24	<i>InetPortNum</i> .....	78
6.5.25	<i>InetHost</i> .....	78
6.5.26	<i>IPHostPrefix</i> .....	78
6.5.27	<i>Ipv4HostPrefix</i> .....	78
6.5.28	<i>Ipv6HostPrefix</i> .....	79
6.5.29	<i>NodeName</i> .....	79
6.5.30	<i>PartialChannelType</i> .....	79
6.5.31	<i>PartialChanReasonType</i> .....	79
6.5.32	<i>PartialServiceType</i> .....	80
6.5.33	<i>PartialServiceReasonType</i> .....	80
6.5.34	<i>PrimaryDsIndicatorType</i> .....	80
6.5.35	<i>QuarterdB</i> .....	80
6.5.36	<i>RcpId</i> .....	81
6.5.37	<i>SchedulingType</i> .....	81
6.5.38	<i>TenthdB</i> .....	81
6.5.39	<i>ThousandthdB</i> .....	81
6.5.40	<i>TriggerFlag</i> .....	81
6.5.41	<i>UpDownTrapEnabled</i> .....	81
6.5.42	<i>UsOfdmaCyclicPrefixType</i> .....	81
6.5.43	<i>UsOfdmaModulationType</i> .....	81
6.5.44	<i>UsOfdmaWindowingSizeType</i> .....	82
6.6	UML Configuration Object Model .....	82
6.6.1	<i>CCAP UML Configuration Object Model Overview</i> .....	82
6.6.2	<i>Vendor-Specific Extensions</i> .....	83
6.6.3	<i>CCAP Configuration Objects</i> .....	84
6.6.4	<i>CCAP Chassis Objects</i> .....	86

6.6.5	<i>CCAP Video Session Configuration Objects</i> .....	96
6.6.6	<i>DOCSIS Configuration Objects</i> .....	118
6.6.7	<i>CCAP Network Configuration Objects</i> .....	217
6.6.8	<i>Interface Configuration Objects</i> .....	234
6.6.9	<i>Management Configuration Objects</i> .....	241
6.6.10	<i>CCAP EPON Configuration Objects</i> .....	255
6.7	<b>Status Monitoring and Control Requirements</b> .....	258
6.7.1	<i>Status Monitoring and Control UML Object Models</i> .....	258
<b>7</b>	<b>PERFORMANCE MANAGEMENT</b> .....	<b>266</b>
7.1	<b>Performance Management Requirements and Transport Protocols</b> .....	266
7.1.1	<i>SNMP and MIB Requirements</i> .....	266
7.2	<b>Performance Management UML Object Models</b> .....	289
7.2.1	<i>State Data Objects</i> .....	289
7.2.2	<i>Statistical Data Objects</i> .....	359
7.3	<b>Proactive Network Maintenance Object Model</b> .....	409
7.3.1	<i>Overview</i> .....	409
7.3.2	<i>Data Type Definitions</i> .....	409
7.3.3	<i>PNM Common Information Model</i> .....	412
7.3.4	<i>PNM Downstream Object Model</i> .....	413
7.3.5	<i>PNM Upstream Object Models</i> .....	418
7.3.6	<i>CCAP Bulk Data Transfer</i> .....	446
7.3.7	<i>Triggering OPT Messages</i> .....	449
7.4	<b>IPDR</b> .....	458
7.4.1	<i>IPDR Service Definitions</i> .....	458
<b>8</b>	<b>ACCOUNTING MANAGEMENT</b> .....	<b>459</b>
8.1	<b>SAMIS</b> .....	459
8.1.1	<i>Subscriber Usage Billing and class of services</i> .....	459
8.1.2	<i>DOCSIS Subscriber Usage Billing Requirements</i> .....	463
8.2	<b>IPDR Protocol</b> .....	463
8.2.1	<i>Introduction</i> .....	463
8.2.2	<i>IP Detail Record (IPDR) Standard</i> .....	464
8.2.3	<i>IPDR Streaming Model</i> .....	467
8.2.4	<i>CCAP IPDR Specifications Support</i> .....	477
8.2.5	<i>Requirements for IPv6</i> .....	479
8.2.6	<i>Data Collection Methodologies for DOCSIS IPDR Service Definitions</i> .....	479
8.2.7	<i>IPDR Streaming Protocol Security Model</i> .....	479
8.3	<b>IPDR Service Definition Schemas</b> .....	480
8.3.1	<i>Requirements for DOCSIS SAMIS Service Definitions</i> .....	481
8.3.2	<i>Requirements for DOCSIS Spectrum Measurement Service Definition</i> .....	483
8.3.3	<i>Requirements for DOCSIS Diagnostic Log Service Definitions</i> .....	483
8.3.4	<i>Requirements for DOCSIS CMTS CM Registration Status Service Definition</i> .....	484
8.3.5	<i>Requirements for DOCSIS CMTS CM Upstream Status Service Definition</i> .....	484
8.3.6	<i>Requirements for DOCSIS CMTS Topology Service Definition</i> .....	484
8.3.7	<i>Requirements for DOCSIS CPE Service Definition</i> .....	484
8.3.8	<i>Requirements for DOCSIS CMTS Upstream Utilization Statistics Service Definition</i> .....	485
8.3.9	<i>Requirements for DOCSIS CMTS Downstream Utilization Statistics Service Definition</i> .....	485
8.3.10	<i>Requirements for DOCSIS CMTS CM Service Flow Service Definition</i> .....	485
8.3.11	<i>Requirements for IP Multicast Statistics Service Definition</i> .....	486
8.3.12	<i>Requirements for DOCSIS CMTS CM Downstream OFDM Service Definition</i> .....	486
8.3.13	<i>Requirements for DOCSIS CMTS CM Downstream OFDM Profile Service Definition</i> .....	486
8.3.14	<i>Requirements for DOCSIS CMTS CM Upstream OFDMA Service Definition</i> .....	487
8.3.15	<i>Requirements for DOCSIS CMTS CM Upstream OFDMA Profile Service Definition</i> .....	487
8.3.16	<i>Requirements for DOCSIS Downstream OFDM Profile Statistics Service Definition</i> .....	487
8.3.17	<i>Requirements for DOCSIS Upstream OFDMA Profile Statistics Service Definition</i> .....	488

8.3.18	<i>Requirements for Auxiliary Schemas</i> .....	488
<b>9</b>	<b>FAULT MANAGEMENT AND REPORTING REQUIREMENTS</b> .....	<b>489</b>
9.1	Fault Management Requirements and Transport Protocols .....	489
9.2	Event Reporting .....	489
9.2.1	<i>SNMP Usage</i> .....	489
9.2.2	<i>Event Notification</i> .....	489
9.2.3	<i>Event Priorities and Vendor-Specific Events</i> .....	494
9.2.4	<i>NETCONF Notifications</i> .....	495
9.2.5	<i>Trap and Syslog Throttling, Limiting and Inhibiting</i> .....	495
9.2.6	<i>Non-SNMP Fault Management Protocols</i> .....	495
9.3	Fault Management UML Object Model .....	495
9.3.1	<i>Event Notification Objects</i> .....	495
<b>ANNEX A</b>	<b>DETAILED MIB REQUIREMENTS (NORMATIVE)</b> .....	<b>498</b>
A.1	MIB Object Details .....	498
A.2	CCAP-MIB Object Details .....	550
A.3	HMS-MIB Object Details .....	551
A.4	PNM MIB Object Details .....	556
<b>ANNEX B</b>	<b>IPDR FOR DOCSIS CABLE DATA SYSTEMS SUBSCRIBER USAGE BILLING RECORDS (NORMATIVE)</b> .....	<b>561</b>
B.1	Service Definition .....	561
B.1.1	<i>DOCSIS Service Requirements</i> .....	561
B.1.2	<i>SAMIS Usage Attribute List</i> .....	562
B.2	IPDR Service Definition Schemas.....	563
<b>ANNEX C</b>	<b>AUXILIARY SCHEMAS FOR DOCSIS IPDR SERVICE DEFINITIONS (NORMATIVE)</b> .....	<b>564</b>
C.1	Overview .....	564
C.2	XML Semantics .....	564
C.2.1	<i>Import Element</i> .....	564
C.2.2	<i>Element References</i> .....	564
C.3	CMTS Information .....	565
C.3.1	<i>CmtsHostName</i> .....	565
C.3.2	<i>CmtsSysUpTime</i> .....	565
C.3.3	<i>CmtsIpv4Addr</i> .....	565
C.3.4	<i>CmtsIpv6Addr</i> .....	565
C.3.5	<i>CmtsMdlfName</i> .....	566
C.3.6	<i>CmtsMdlfIndex</i> .....	566
C.4	CM Information Schema .....	566
C.5	Record Information.....	566
C.5.1	<i>RecType</i> .....	566
C.5.2	<i>RecCreationTime</i> .....	566
C.6	QoS Information .....	567
C.6.1	<i>ServiceFlowChSet</i> .....	567
C.6.2	<i>ServiceAppId</i> .....	567
C.6.3	<i>ServiceDsMulticast</i> .....	567
C.6.4	<i>ServiceIdentifier</i> .....	567
C.6.5	<i>ServiceGateId</i> .....	567
C.6.6	<i>ServiceClassName</i> .....	567
C.6.7	<i>ServiceDirection</i> .....	568
C.6.8	<i>ServiceOctetsPassed</i> .....	568
C.6.9	<i>ServicePktsPassed</i> .....	568
C.6.10	<i>ServiceSlaDropPkts</i> .....	568
C.6.11	<i>ServiceSlaDelayPkts</i> .....	568
C.6.12	<i>ServiceTimeCreated</i> .....	569

C.6.13	<i>ServiceTimeActive</i> .....	569
C.7	CPE Information.....	569
C.7.1	<i>CpeMacAddr</i> .....	569
C.7.2	<i>CpeIpv4AddrList</i> .....	569
C.7.3	<i>CpeIpv6AddrList</i> .....	569
C.7.4	<i>CpeFqdn</i> .....	570
C.8	Spectrum Measurement Information.....	570
C.9	Diagnostic Log Information.....	570
C.10	CMTS CM Upstream Status Information.....	570
C.11	CMTS CM Node Channel Information.....	570
C.12	CMTS MAC Domain Node Information.....	570
C.13	CMTS Upstream Utilization Information.....	570
C.13.1	<i>IfIndex</i> .....	571
C.13.2	<i>ifName</i> .....	571
C.13.3	<i>UsChId</i> .....	571
C.13.4	<i>Interval</i> .....	571
C.13.5	<i>IndexPercentage</i> .....	571
C.13.6	<i>TotalMslots</i> .....	571
C.13.7	<i>UcastGrantedMslots</i> .....	571
C.13.8	<i>TotalCntnMslots</i> .....	572
C.13.9	<i>UsedCntnMslots</i> .....	572
C.13.10	<i>CollCntnMslots</i> .....	572
C.13.11	<i>TotalCntnReqMslots</i> .....	572
C.13.12	<i>UsedCntnReqMslots</i> .....	572
C.13.13	<i>CollCntnReqMslots</i> .....	572
C.13.14	<i>TotalCntnReqDataMslots</i> .....	572
C.13.15	<i>UsedCntnReqDataMslots</i> .....	572
C.13.16	<i>CollCntnReqDataMslots</i> .....	573
C.13.17	<i>TotalCntnInitMaintMslots</i> .....	573
C.13.18	<i>UsedCntnInitMaintMslots</i> .....	573
C.13.19	<i>CollCntnInitMaintMslots</i> .....	573
C.14	CMTS Downstream Utilization Information.....	573
C.14.1	<i>IfIndex</i> .....	573
C.14.2	<i>IfName</i> .....	573
C.14.3	<i>DsChId</i> .....	573
C.14.4	<i>Interval</i> .....	573
C.14.5	<i>IndexPercentage</i> .....	574
C.14.6	<i>TotalBytes</i> .....	574
C.14.7	<i>UsedBytes</i> .....	574
C.15	Service Flow Information.....	574
C.15.1	<i>ServiceTrafficPriority</i> .....	575
C.15.2	<i>ServiceMaxSustained</i> .....	575
C.15.3	<i>ServiceMaxBurst</i> .....	575
C.15.4	<i>ServiceMinReservedRate</i> .....	575
C.15.5	<i>ServiceMinReservedPktSize</i> .....	575
C.15.6	<i>ServiceIpTos</i> .....	575
C.15.7	<i>ServicePeakRate</i> .....	575
C.15.8	<i>ServiceSchedule</i> .....	575
C.15.9	<i>ServiceNomPollInterval</i> .....	575
C.15.10	<i>ServiceTolPollJitter</i> .....	575
C.15.11	<i>ServiceUGSize</i> .....	575
C.15.12	<i>ServiceNomGrantInterval</i> .....	575
C.15.13	<i>ServiceTolGrantJitter</i> .....	575
C.15.14	<i>ServiceGrantsPerInterval</i> .....	575
C.15.15	<i>ServicePacketClassifiers</i> .....	576
C.16	IP Multicast Information.....	576

C.16.1	<i>IpMcastSrcIpv4Addr</i> .....	576
C.16.2	<i>IpMcastSrcIpv6Addr</i> .....	576
C.16.3	<i>IpMcastGrpIpv4Addr</i> .....	576
C.16.4	<i>IpMcastGrpIpv6Addr</i> .....	576
C.16.5	<i>IpMcastGsflid</i> .....	576
C.16.6	<i>IpMcastDsid</i> .....	576
C.16.7	<i>IpMcastSessionProtocolType</i> .....	577
C.16.8	<i>IpMcastCpeMacAddrList</i> .....	577
C.16.9	<i>IpMcastJoinTime</i> .....	577
C.16.10	<i>IpMcastLeaveTime</i> .....	577
C.17	CMTS CM Downstream OFDM Information .....	577
C.18	CMTS CM Partial Channel/Service Information.....	577
C.19	CMTS CM Upstream OFDMA Information .....	577
C.20	OFDM Profile Status Information .....	577
<b>ANNEX D</b>	<b>FORMAT AND CONTENT FOR EVENT, SYSLOG, AND SNMP NOTIFICATION</b>	
<b>(NORMATIVE)</b>	<b>.....</b>	<b>578</b>
D.1	Deprecated Events .....	604
D.2	Example SNMP Notification and Syslog Event Message .....	606
<b>ANNEX E</b>	<b>EXTENDING THE CONFIGURATION DATA MODEL (NORMATIVE)</b>	<b>607</b>
E.1	XML Schema Extension .....	607
E.1.1	<i>Sample Vendor-Specific XSD Extensions</i> .....	607
E.2	YANG Configuration Model Extension .....	610
E.2.1	<i>YANG Extension Principles</i> .....	610
E.2.2	<i>Creating Vendor Extensions</i> .....	610
E.2.3	<i>Example Vendor-Proprietary Extensions in YANG Configuration Messages</i> .....	612
<b>ANNEX F</b>	<b>CCAP DATA TYPE DEFINITIONS (NORMATIVE)</b>	<b>614</b>
F.1	Overview .....	614
F.2	Data Types Mapping.....	614
F.3	Data Types Requirements and Classification .....	614
F.4	Data Type Mapping Methodology.....	614
F.5	General Data Types (SNMP and IPDR Mapping).....	615
F.6	Primitive Data Types (YANG Mapping).....	616
F.7	Extended Data Types (SNMP and IPDR Mapping) .....	616
F.8	Derived Data Types (YANG Mapping).....	617
<b>ANNEX G</b>	<b>DIAGNOSTIC LOG (NORMATIVE)</b>	<b>618</b>
G.1	Overview .....	618
G.2	Object Definitions.....	618
G.2.1	<i>Type Definitions</i> .....	620
G.2.2	<i>LogGlobal Object</i> .....	620
G.2.3	<i>LogTriggersCfg Object</i> .....	621
G.2.4	<i>Log Object</i> .....	622
G.2.5	<i>LogDetail Object</i> .....	623
<b>APPENDIX I</b>	<b>SAMPLE CCAP XML CONFIGURATION (INFORMATIVE)</b>	<b>625</b>
I.1	CCAP XML Configuration File.....	625
I.2	CCAP Partial Configuration .....	666
I.3	Sample NETCONF Message Exchanges.....	666
I.3.1	<i>Changes Made to running-config without Locks or Timeouts</i> .....	666
I.3.2	<i>Changes Made to candidate-config with a Lock</i> .....	668
<b>APPENDIX II</b>	<b>USE CASES (INFORMATIVE)</b>	<b>670</b>
II.1	Identifying Replicated QAMs.....	670

**APPENDIX III VENDOR SCHEMA VERSION IN THE CCAP XSD (INFORMATIVE) .....671**

**APPENDIX IV CONVERTING YANG TO XSD (INFORMATIVE).....672**

IV.1 Using PYANG to Generate an XSD from the CCAP YANG Modules..... 672

IV.1 Creating In-Line Data Types in the CCAP.XSD ..... 672

**APPENDIX V DOCSIS IPDR SAMPLE INSTANCE DOCUMENTS (INFORMATIVE) .....674**

V.1 Collector Aggregation .....674

V.2 Schema Location .....674

V.3 DIAG-LOG-TYPE .....674

    V.3.1 Use Case .....674

    V.3.2 Instance Document .....674

V.4 DIAG-LOG-DETAIL-TYPE.....675

    V.4.1 Use Case .....675

    V.4.2 Instance Document .....675

V.5 DIAG-LOG-EVENT-TYPE .....675

    V.5.1 Use Case .....675

    V.5.2 Instance Document .....676

V.6 SPECTRUM-MEASUREMENT-TYPE .....676

    V.6.1 Use Case .....676

    V.6.2 Instance Document .....676

V.7 CMTS-CM-US-STATS-TYPE.....678

    V.7.1 Use Case .....678

    V.7.2 Instance Document .....678

V.8 CMTS-CM-REG-STATUS-TYPE.....679

    V.8.1 Use Case .....679

    V.8.2 Instance Document .....679

V.9 CMTS-TOPOLOGY-TYPE .....680

    V.9.1 Use Case .....680

    V.9.2 Instance Document .....680

V.10 CPE-TYPE.....681

    V.10.1 Use Case .....681

    V.10.2 Instance Document .....681

V.11 SAMIS-TYPE-1 and SAMIS-TYPE-2 .....681

    V.11.1 Use Case .....681

    V.11.2 SAMIS Type 1 Instance Document.....683

    V.11.3 SAMIS Type 2 Instance Document.....684

V.12 CMTS-US-UTIL-STATS-TYPE.....685

    V.12.1 Use Case .....685

    V.12.2 Instance Document .....685

V.13 CMTS-DS-UTIL-STATS-TYPE.....686

    V.13.1 Use Case .....686

    V.13.2 Instance Document .....686

V.14 CMTS-CM-SERVICE-FLOW-TYPE .....687

    V.14.1 Use Case .....687

    V.14.2 Instance Document .....687

**APPENDIX VI SPECTRUM ANALYSIS USE CASES (INFORMATIVE).....689**

VI.1 Normalization of RF Impairments Measurements.....689

    VI.1.1 Problem Description.....689

    VI.1.2 Use Cases .....689

VI.2 Upstream Spectrum Measurement Monitoring.....691

    VI.2.1 Problem Description.....691

    VI.2.2 Use Cases .....691

**APPENDIX VII INFORMATION MODEL NOTATION (INFORMATIVE) .....696**

VII.1	Overview .....	696
VII.2	Information Model Diagram .....	696
VII.2.1	Classes .....	696
VII.2.2	Associations .....	696
VII.2.3	Generalization .....	696
VII.2.4	Dependencies .....	697
VII.2.5	Comment .....	697
VII.2.6	Diagram Notation .....	697
VII.3	Object Instance Diagram .....	697
VII.4	ObjectA Definition Example .....	698
VII.5	Common Terms Shortened .....	698
VII.5.1	Exceptions .....	699
<b>APPENDIX VIII</b>	<b>ACKNOWLEDGMENTS (INFORMATIVE) .....</b>	<b>700</b>
<b>APPENDIX IX</b>	<b>REVISION HISTORY .....</b>	<b>701</b>

## Figures

Figure 1-1 - The DOCSIS Network.....	26
Figure 1-2 - Data-over-Cable Reference Architecture.....	27
Figure 1-3 - CCAP Interface Reference Architecture.....	28
Figure 1-4 - Transparent IP Traffic through the Data-Over-Cable System .....	28
Figure 5-1 - Fault Management Use Cases.....	53
Figure 5-2 - Configuration Management Use Cases.....	54
Figure 5-3 - CMTS and CCAP Management Architecture.....	56
Figure 6-1 - CCAP XML File-Based Configuration Use Case.....	61
Figure 6-2 - CCAP NETCONF-Based Configuration Use Case .....	69
Figure 6-3 - CCAP Configuration Objects .....	84
Figure 6-4 - CCAP Chassis Objects .....	86
Figure 6-5 - CCAP Video Session Configuration Objects .....	96
Figure 6-6 - DOCSIS Configuration Objects.....	118
Figure 6-7 - DOCSIS Security Configuration Objects .....	123
Figure 6-8 - DOCSIS Subscriber Management Configuration Objects.....	131
Figure 6-9 - DOCSIS QoS Configuration Objects .....	138
Figure 6-10 - DOCSIS Multicast QoS Configuration Objects.....	146
Figure 6-11 - MAC Domain Configuration Objects.....	152
Figure 6-12 - DOCSIS Multicast Authorization Configuration Objects.....	165
Figure 6-13 - DOCSIS Upstream Interface Configuration Objects .....	170
Figure 6-14 - Downstream DOCSIS and Video Configuration Objects.....	183
Figure 6-15 - DSG Configuration Objects.....	196
Figure 6-16 - PacketCable Configuration Objects.....	205
Figure 6-17 - Load Balance Configuration Objects.....	209
Figure 6-18 - CCAP Network Configuration Objects .....	217
Figure 6-19 - Interface Configuration Objects.....	234
Figure 6-20 - Management Configuration Objects .....	241
Figure 6-21 - Fault Management Configuration Objects.....	242
Figure 6-22 - SNMP Agent Configuration Objects .....	248
Figure 6-23 - IPDR Configuration Objects.....	252
Figure 6-24 - EPON Configuration Objects .....	256
Figure 6-25 - Fault Management Control Objects.....	258
Figure 6-26 - Performance Management Control and Monitoring Information Model.....	259
Figure 7-1 - ifStack Table for CCAP RF Interfaces .....	278
Figure 7-2 - CMTS Bonding Performance Management Objects .....	290
Figure 7-3 - RxCh Performance Management Objects.....	296
Figure 7-4 - DOCS-L2VPN-MIB: State Objects.....	301
Figure 7-5 - DOCSIS Load Balance Status Information Model.....	302
Figure 7-6 - DOCS-MCAST-AUTH-MIB Performance Management Objects .....	309
Figure 7-7 - DOCSIS QoS State Performance Management Information Model.....	314
Figure 7-8 - DOCS-SEC-MIB Performance Management Objects.....	340
Figure 7-9 - DOCS-SUBMGT3-MIB Performance Management Objects.....	344



Figure 7-10 - CCAP Topology Performance Management Objects .....	350
Figure 7-11 - CCAP-MIB Performance Management Objects.....	352
Figure 7-12 - SCTE-HMS-MPEG-MIB: State Objects Performance Management Objects .....	357
Figure 7-13 - DOCS-DRF-MIB Performance Management Objects .....	358
Figure 7-14 - DOCS-IF-MIB Performance Management Objects.....	359
Figure 7-15 - CMTS CM Status Information Model.....	360
Figure 7-16 - DOCS-L2VPN-MIB: Statistics Objects .....	373
Figure 7-17 - DOCS-MCAST-MIB Performance Management Objects.....	375
Figure 7-18 – DOCSIS QoS Statistical Performance Management Information Model .....	380
Figure 7-19 - Upstream OFDMA Status Objects .....	392
Figure 7-20 - Downstream OFDM Status Objects .....	399
Figure 7-21 - DOCS-IF3-MIB Statistical Performance Management Information Model.....	408
Figure 7-22 - PNM Common Information Model .....	412
Figure 7-23 - Downstream PNM Object Model.....	414
Figure 7-24 - Upstream PNM Information Model.....	419
Figure 7-25 - Upstream Triggered Spectrum Capture Information Model.....	433
Figure 7-26 - CCAP OPT PNM Information Model .....	450
Figure 8-1 - Basic Network Model (ref. [IPDR/BSR]).....	464
Figure 8-2 - IPDRDoc 3.5.1 Master Schema.....	465
Figure 8-3 - Sequence Diagram for DOCSIS Time Interval Session Streaming Requirements .....	471
Figure 8-4 - Sequence Diagram for DOCSIS Event Based Session Streaming Requirement .....	472
Figure 8-5 - Sequence Diagram for DOCSIS Ad-hoc Based Session Streaming Requirement.....	473
Figure 8-6 - Sequence Diagram for a Multisession Streaming Example.....	475
Figure 8-7 - Billing Collection Interval Example .....	482
Figure 9-1 - CCAP Event Notification Objects .....	496
Figure C-1 - Auxiliary Schema Import.....	564
Figure G-1 - Diagnostic Log Object Model Diagram.....	619
Figure II-1 - Identifying a Replicated QAM by Looking at mpegOutputTSTSID .....	670
Figure V-1 - Set of CM Services in an Arbitrary Period of Time (Left Graphic) Set of Records Associated to the Collection Interval 10:30 to 11:00 AM (Right Graphic) .....	683
Figure VI-1 - Sequence Diagram for Streaming of Spectrum Analysis Measurement Data .....	693
Figure VI-2 - Spectrum Amplitude Constructed Graph from Collected Data .....	695
Figure VI-3 - Spectrum Amplitude Detail Graph from Collected Data.....	695
Figure VII-1 - Object Model UML Class Diagram Notation .....	697
Figure VII-2 - Object Instance Diagram for ObjectA.....	697

## Tables

Table 1-1 - DOCSIS 3.1 Series of Specifications.....	29
Table 4-1 - Public XML Namespaces.....	50
Table 4-2 - IPDR Service Definition Namespaces .....	50
Table 4-3 - Auxiliary Schema Namespaces.....	51
Table 5-1 - Management Feature Requirements for DOCSIS 3.1 .....	56
Table 6-1 - TLS Certificate Profile.....	68
Table 6-2 - Data Types .....	70
Table 6-3 - Pre-3.0 DOCSIS and DOCSIS 3.0/3.1 CMTS CM Registration Status Mapping .....	76
Table 6-4 - Ccap Object Attributes.....	84
Table 6-5 - Ccap Object Associations .....	84
Table 6-6 - Chassis Object Associations .....	87
Table 6-7 - Slot Object Attributes.....	87
Table 6-8 - Slot Object Associations .....	87
Table 6-9 - LineCard Abstract Object Attributes .....	88
Table 6-10 - LineCard Object Associations.....	88
Table 6-11 - RfLineCard Object Associations.....	88
Table 6-12 - EponLineCard Object Associations .....	89
Table 6-13 - SreLineCard Object Associations .....	89
Table 6-14 - Port Object Attributes .....	89
Table 6-15 - DsRfPort Object Attributes.....	90
Table 6-16 - DsRfPort Object Associations.....	90
Table 6-17 - FiberNodeCfg Object Attributes .....	91
Table 6-18 - FiberNodeCfg Object Associations.....	91
Table 6-19 - UsRfPort Object Associations.....	92
Table 6-20 - EnetPort Object Associations.....	92
Table 6-21 - OneGigEthernet Object Attributes.....	92
Table 6-22 - OneGigEthernet Object Associations .....	92
Table 6-23 - TenGigEthernet Object Associations .....	93
Table 6-24 - FortyGigEthernet Object Associations .....	93
Table 6-25 - OneHundredGigEthernet Object Associations.....	93
Table 6-26 - PonPort Object Associations.....	93
Table 6-27 - OneGigEpon Object Attributes .....	94
Table 6-28 - OneGigEpon Object Associations.....	94
Table 6-29 - TenGigEpon Object Attributes .....	94
Table 6-30 - TenGigEpon Object Associations .....	95
Table 6-31 - VideoCfg Object Associations .....	96
Table 6-32 - GlobalInputTsCfg Object Attributes.....	97
Table 6-33 - GlobalOutputTsCfg Object Attributes .....	97
Table 6-34 - UdpMap Object Attributes.....	98
Table 6-35 - StaticUdpMap Object Associations .....	98
Table 6-36 - ReservedUdpMap Object Associations.....	99
Table 6-37 - ReservedPidRange Object Attributes.....	99

Table 6-38 - InputRegistration Object Attributes .....	99
Table 6-39 - CasInfo Object Attributes .....	100
Table 6-40 - EncryptionData Object Attributes .....	101
Table 6-41 - EncryptControl Object Attributes .....	102
Table 6-42 - VideoInputTs Object Attributes .....	103
Table 6-43 - VideoInputTs Object Associations .....	103
Table 6-44 - UnicastVideoInputTs Object Attributes .....	103
Table 6-45 - UnicastVideoInputTs Object Associations .....	104
Table 6-46 - MulticastVideoInputTs Object Attributes .....	104
Table 6-47 - MulticastVideoInputTs Object Associations .....	104
Table 6-48 - VideoOutputTs Object Attributes .....	105
Table 6-49 - VideoOutputTs Object Associations .....	105
Table 6-50 - ErmParams Object Attributes .....	106
Table 6-51 - ErmParams Object Associations .....	106
Table 6-52 - EncryptionCapability Object Attributes .....	107
Table 6-53 - ErmRegistration Object Attributes .....	108
Table 6-54 - VideoSession Object Attributes .....	110
Table 6-55 - VideoSession Object Associations .....	110
Table 6-56 - ProgramSession Object Attributes .....	110
Table 6-57 - ProgramSession Object Associations .....	111
Table 6-58 - MptsPassThruSession Object Associations .....	111
Table 6-59 - PidSession Object Attributes .....	112
Table 6-60 - PidSession Object Associations .....	112
Table 6-61 - Decryptor Object Attributes .....	113
Table 6-62 - Decryptor Object Associations .....	113
Table 6-63 - EcmdUsage Object Attributes .....	113
Table 6-64 - EcmdUsage Object Associations .....	114
Table 6-65 - Ecmd Object Attributes .....	114
Table 6-66 - Ecmd Object Associations .....	114
Table 6-67 - Ecm Object Attributes .....	114
Table 6-68 - Encryptor Object Attributes .....	115
Table 6-69 - Encryptor Object Associations .....	115
Table 6-70 - EcmgUsage Object Attributes .....	116
Table 6-71 - EcmgUsage Object Associations .....	116
Table 6-72 - Ecmg Object Attributes .....	117
Table 6-73 - Ecmg Object Associations .....	117
Table 6-74 - StaticUdpMapEncryption Object Attributes .....	117
Table 6-75 - StaticUdpMapEncryption Object Associations .....	117
Table 6-76 - DocsCfg Object Associations .....	119
Table 6-77 - DocsisGlobalCfg Object Attributes .....	120
Table 6-78 - CmRemoteQuery Object Attributes .....	121
Table 6-79 - CmRemoteQuery Object Associations .....	121
Table 6-80 - CmVendorOui Object Attributes .....	121
Table 6-81 - OfdmGuardBandCfg Object Attributes .....	122

Table 6-82 - SecCfg Object Associations ..... 123

Table 6-83 - SavCfgList Object Attributes ..... 124

Table 6-84 - SavCfgList Object Associations ..... 124

Table 6-85 - SavRule Object Attributes ..... 124

Table 6-86 - CmtsSavCtrl Object Attributes ..... 125

Table 6-87 - CmtsServerCfg Object Attributes ..... 126

Table 6-88 - CmtsEncrypt Object Attributes ..... 126

Table 6-89 - CmtsCertificate Object Attributes ..... 127

Table 6-90 - CmtsCertRevocationList Object Attributes ..... 127

Table 6-91 - CmtsCmEaeExclusion Object Attributes ..... 128

Table 6-92 - CmtsOnlineCertStatusProtocol Object Attributes ..... 129

Table 6-93 - CmtsCmBpi2EnforceExclusion Object Attributes ..... 129

Table 6-94 - SysBpiCfg Object Attributes ..... 130

Table 6-95 - SubMgmtCfg Object Associations ..... 132

Table 6-96 - Base Object Attributes ..... 132

Table 6-97 - FilterGrp Object Attributes ..... 134

Table 6-98 - DocsQosCfg Object Attributes ..... 138

Table 6-99 - DocsQosCfg Object Associations ..... 139

Table 6-100 - ServiceClass Object Attributes ..... 139

Table 6-101 - AsfQosProfile Object Attributes ..... 144

Table 6-102 - IatcProfile Object Attributes ..... 144

Table 6-103 - IatcProfile Object Associations ..... 144

Table 6-104 - IatcAppIdObject Attributes ..... 145

Table 6-105 - IatcScn Object Attributes ..... 145

Table 6-106 - GrpCfg Object Associations ..... 147

Table 6-107 - CmtsGrpCfg Object Attributes ..... 148

Table 6-108 - CmtsGrpCfg Object Associations ..... 148

Table 6-109 - CmtsGrpEncryptCfg Object Attributes ..... 149

Table 6-110 - CmtsGrpQosCfg Object Attributes ..... 150

Table 6-111 - CmtsGrpQosCfg Object Associations ..... 150

Table 6-112 - DefGrpSvcClass Object Associations ..... 151

Table 6-113 - MacCfg Object Associations ..... 153

Table 6-114 - MdCfg Object Attributes ..... 153

Table 6-115 - MdCfg Object Associations ..... 154

Table 6-116 - MdBpiCfg Object Attributes ..... 157

Table 6-117 - MacDomainCfg Object Attributes ..... 157

Table 6-118 - IfCmtsMacCfg Object Attributes ..... 158

Table 6-119 - DsBondingGrpCfg Object Attributes ..... 159

Table 6-120 - DsBondingGrpCfg Object Associations ..... 159

Table 6-121 - UsBondingGrpCfg Object Attributes ..... 160

Table 6-122 - UsBondingGrpCfg Object Associations ..... 160

Table 6-123 - RccCfg Object Attributes ..... 161

Table 6-124 - RccCfg Object Associations ..... 161

Table 6-125 - RxChCfg Object Attributes ..... 162

Table 6-126 - RxChCfg Object Associations .....	162
Table 6-127 - RxModuleCfg Object Attributes .....	163
Table 6-128 - RxModuleCfg Object Associations.....	163
Table 6-129 - DenyCm Object Attributes.....	163
Table 6-130 - McastAuthCfg Object Associations .....	166
Table 6-131 - Profiles Object Attributes.....	166
Table 6-132 - Profiles Object Associations .....	166
Table 6-133 - Ctrl Object Attributes.....	166
Table 6-134 - Ctrl Object Associations .....	167
Table 6-135 - ProfileSessRule Object Attributes.....	168
Table 6-136 - Ctrl Object Associations .....	168
Table 6-137 - Ssm Object Attributes .....	169
Table 6-138 - DocsIfCfg Object Associations.....	170
Table 6-139 - ModulationProfile Object Attributes.....	171
Table 6-140 - ModulationProfile Object Associations .....	171
Table 6-141 - IntervalUsageCode Object Attributes .....	171
Table 6-142 - UpstreamPhysicalChannel Object Attributes.....	172
Table 6-143 - UpstreamPhysicalChannel Object Associations .....	172
Table 6-144 - UpstreamLogicalChannel Object Attributes .....	173
Table 6-145 - UpstreamLogicalChannel Object Associations.....	174
Table 6-146 - ScdmaLogicalChannel Object Attributes.....	175
Table 6-147 - ScdmaLogicalChannel Object Associations .....	175
Table 6-148 - TdmaLogicalChannel Object Associations.....	176
Table 6-149 - AtdmaLogicalChannel Object Associations .....	176
Table 6-150 - TdmaAndAtdmaLogicalChannel Object Associations .....	176
Table 6-151 - UsOfdmaChannelCfg Object Attributes .....	176
Table 6-152 - UsOfdmaChannelCfg Object Associations.....	177
Table 6-153 - UsOfdmaChanDataIuc Object Attributes.....	178
Table 6-154 - UsOfdmaChanDataIuc Object Associations .....	178
Table 6-155 - UsOfdmaMinislotCfg Object Attributes .....	179
Table 6-156 - UsOfdmaExclusion Object Attributes.....	180
Table 6-157 - UsOfdmaModulationTemplate Object Attributes.....	180
Table 6-158 - UsOfdmaModulationTemplate Object Associations.....	180
Table 6-159 - UsOfdmaInitialRangingIuc Object Attributes.....	181
Table 6-160 - UsOfdmaFineRangingIuc Object Attributes .....	182
Table 6-161 - UsOfdmaDataIuc Object Attributes .....	182
Table 6-162 - DownChannel Object Attributes .....	184
Table 6-163 - DownChannel Object Associations.....	184
Table 6-164 - DocsisDownChannel Object Attributes .....	187
Table 6-165 - DocsisDownChannel Object Associations.....	187
Table 6-166 - VideoDownChannel Object Attributes .....	188
Table 6-167 - VideoDownChannel Object Associations.....	188
Table 6-168 - DocsisPhyProfile Object Attributes .....	188
Table 6-169 - DocsisPhyProfile Object Associations.....	188

Table 6-170 - VideoPhyProfile Object Attributes ..... 189

Table 6-171 - VideoPhyProfile Object Associations..... 189

Table 6-172 - DownChannelPhyParams Object Attributes ..... 189

Table 6-173 - DsOfdmChannelCfg Object Attributes ..... 190

Table 6-174 - DsOfdmChannelCfg Object Associations..... 191

Table 6-175 - DsOfdmProfileCfg Object Attributes..... 193

Table 6-176 - DsOfdmProfileCfg Object Associations ..... 193

Table 6-177 - DsOfdmSubcarrierCfg Object Attributes..... 193

Table 6-178 - DsOfdmExclusionCfg Object Attributes ..... 194

Table 6-179 - DsNcpExclusionCfg Object Attributes ..... 194

Table 6-180 - DsgCfg Object Associations ..... 197

Table 6-181 - TimerCfg Object Attributes ..... 197

Table 6-182 - DsgDownstream Object Attributes ..... 198

Table 6-183 - DsgDownstream Object Associations..... 198

Table 6-184 - DsgChannelList Object Attributes ..... 199

Table 6-185 - DsgChannelList Object Associations..... 199

Table 6-186 - DsgChannel Object Attributes ..... 199

Table 6-187 - TunnelGroupToChannelList Object Attributes..... 200

Table 6-188 - TunnelGrpToChannel Object Associations ..... 200

Table 6-189 - TunnelGroupChannel Object Attributes ..... 200

Table 6-190 - TunnelGroupChannel Object Associations ..... 200

Table 6-191 - Classifier Object Attributes..... 201

Table 6-192 - Classifier Object Associations ..... 201

Table 6-193 - TunnelCfg Object Attributes..... 202

Table 6-194 - TunnelCfg Object Associations ..... 202

Table 6-195 - ClientIdCfgList Object Attributes..... 202

Table 6-196 - ClientIdCfgList Object Associations ..... 203

Table 6-197 - DsgClient Object Attributes ..... 203

Table 6-198 - DsgClient Object Associations ..... 203

Table 6-199 - VendorParametersList Object Associations ..... 204

Table 6-200 - PcCfg Object Associations..... 205

Table 6-201 - PacketCableConfig Object Attributes ..... 206

Table 6-202 - PcEventCfg Object Attributes..... 207

Table 6-203 - LoadBalanceCfg Object Attributes ..... 209

Table 6-204 - LoadBalanceCfg Object Associations..... 210

Table 6-205 - GeneralGrpCfg Object Attributes ..... 210

Table 6-206 - GeneralGroupCfg Object Associations ..... 210

Table 6-207 - FiberNodeListEntry Object Attributes ..... 211

Table 6-208 - FiberNodeListEntry Object Associations..... 211

Table 6-209 - GeneralGrpDefaults Object Attributes..... 212

Table 6-210 - GeneralGrpDefaults Object Associations ..... 212

Table 6-211 - BasicRule Object Attributes..... 212

Table 6-212 - BasicRule Object Associations ..... 213

Table 6-213 - Policy Object Attributes..... 213

Table 6-214 - Policy Object Associations .....	213
Table 6-215 - LoadBalanceRule Object Attributes.....	214
Table 6-216 - ResGrpCfg Object Attributes.....	214
Table 6-217 - ResGrpCfg Object Associations .....	214
Table 6-218 - RestrictCmCfg Object Attributes.....	215
Table 6-219 - RestrictCmCfg Object Associations .....	216
Table 6-220 - NetworkCfg Object Associations.....	218
Table 6-221 - DnsResolver Object Attributes .....	218
Table 6-222 - DnsServer Object Attributes .....	218
Table 6-223 - IntegratedServers Object Attributes .....	219
Table 6-224 - IntegratedServers Object Associations.....	219
Table 6-225 - SshServer Object Attributes .....	220
Table 6-226 - SshServer Object Associations .....	220
Table 6-227 - TelnetServer Object Attributes .....	221
Table 6-228 - TelnetServer Object Associations .....	221
Table 6-229 - AuthenticationPolicy Object Attributes .....	222
Table 6-230 - LocalAuth Object Attributes .....	223
Table 6-231 - Authorizer Object Attributes.....	223
Table 6-232 - Authorizer Object Associations .....	223
Table 6-233 - Radius Object Attributes.....	224
Table 6-234 - Radius Object Associations .....	224
Table 6-235 - TacacsPlus Object Attributes .....	225
Table 6-236 - TacacsPlus Object Associations.....	225
Table 6-237 - KeyChain Object Attributes .....	225
Table 6-238 - IpAcl Object Attributes .....	226
Table 6-239 - IpAcl Object Associations .....	226
Table 6-240 - IpAclRule Object Attributes .....	226
Table 6-241 - UserTerminal Object Attributes .....	230
Table 6-242 - UserTerminal Object Associations .....	230
Table 6-243 - VirtualTerminal Object Attributes .....	230
Table 6-244 - VirtualTerminal Object Associations.....	231
Table 6-245 - ConsoleTerminal Object Associations .....	231
Table 6-246 - TerminalService Object Attributes .....	231
Table 6-247 - TerminalService Object Associations .....	231
Table 6-248 - InputTransportControls Object Attributes .....	232
Table 6-249 - FailOver Object Attributes.....	232
Table 6-250 - LocalTime Object Attributes.....	232
Table 6-251 - LocalTime Object Associations .....	233
Table 6-252 - IfCfg Object Associations .....	234
Table 6-253 - Loopback Object Associations.....	235
Table 6-254 - VirtualInterfaceObject Attributes.....	235
Table 6-255 - VirtualInterface Object Associations .....	235
Table 6-256 - IpInterface Object Attributes.....	235
Table 6-257 - IpInterface Object Associations .....	236

Table 6-258 - PrimaryIpv4 Object Attributes .....236

Table 6-259 - Ipv6 Object Attributes.....236

Table 6-260 - SecondaryIpv4 Object Attributes .....237

Table 6-261 - CableBundle Object Attributes .....237

Table 6-262 - CableBundle Object Associations.....237

Table 6-263 - CableHelperCfg Object Attributes .....237

Table 6-264 - SecondaryGiAddr Object Attributes .....238

Table 6-265 - MgmRouterInterface Object Attributes .....239

Table 6-266 - MgmtCfg Object Associations .....241

Table 6-267 - FmCfg Object Associations .....243

Table 6-268 - CmtsEventCtrl Object.....244

Table 6-269 - DiagLogGlobalCfg Object Attributes .....244

Table 6-270 - DiagLogTriggersCfg Object Attributes .....245

Table 6-271 - SyslogServer Object Attributes.....247

Table 6-272 - SyslogServer Object Associations .....247

Table 6-273 - SnmpCfg Object Associations .....249

Table 6-274 - AccessCfg Object Attributes.....249

Table 6-275 - AccessCfg Object Associations .....249

Table 6-276 - ViewCfg Object Attributes .....250

Table 6-277 - NotifReceiverCfg Object Attributes .....250

Table 6-278 - NotifReceiverCfg Object Associations .....251

Table 6-279 - IpdrCfg Object Associations .....252

Table 6-280 - IpdrExporterCfg Object Attributes .....252

Table 6-281 - IpdrExporterCfg Object Associations .....253

Table 6-282 - StreamingSession Object Attributes.....253

Table 6-283 - StreamingSession Object Associations .....253

Table 6-284 - Template Object Attributes .....254

Table 6-285 - Collector Object Attributes .....255

Table 6-286 - EponCfg Object Associations .....256

Table 6-287 - EponMdCfg Object Associations.....257

Table 6-288 - DenyOnu Object Attributes.....257

Table 6-289 - FmCtrl Object Associations .....258

Table 6-290 - CmtsSignalQualityExt Object.....260

Table 6-291 - CmtsCmCtrlCmd Object.....260

Table 6-292 - ChgOverGroup Object .....261

Table 6-293 - CmtsDebugDsid Object .....264

Table 7-1 - IETF SNMP-related RFCs .....267

Table 7-2 - SMIv2 IETF SNMP-related RFCs .....268

Table 7-3 - Diffie-Helman IETF SNMP-related RFC .....268

Table 7-4 - CableLabs MIBs .....269

Table 7-5 - IETF RFC MIBs .....270

Table 7-6 - docsIfDownChannelTable Requirements for OFDM Channels.....272

Table 7-7 - docsIfUpChannelTable Requirements for OFDMA Channels.....273

Table 7-8 - IF-MIB Counter Rules .....276



Table 7-9 - CCAP ifStack Table Representation.....	278
Table 7-10 - IfTable/IfXTable Details for Ethernet Interfaces.....	279
Table 7-11 - IfTable/IfXTable for RF and DOCSIS Interfaces.....	280
Table 7-12 - CCAP ifCounters Information.....	281
Table 7-13 - entPhysicalTable Requirements.....	284
Table 7-14 - MdUsToDsChMapping Object.....	291
Table 7-15 - DsChSet Object.....	291
Table 7-16 - UsChSet Object.....	292
Table 7-17 - DsBondingGrpStatus Object.....	292
Table 7-18 - UsBondingGrpStatus Object.....	293
Table 7-19 - BondingGrpCfg Object.....	293
Table 7-20 - MdChCfg Object.....	294
Table 7-21 - RccStatus Object.....	296
Table 7-22 - RxModuleStatus Object.....	297
Table 7-23 - RxChStatus Object.....	298
Table 7-24 - RxChStatus Object.....	299
Table 7-25 - UsChExt Object Attributes.....	299
Table 7-26 - CmtsCmParams Object Attributes.....	303
Table 7-27 - GrpStatus Object Attributes.....	304
Table 7-28 - ChgOverStatus Object.....	305
Table 7-29 - LoadBalanceStatus Object.....	308
Table 7-30 - CmtsCmStatus Object Attributes.....	309
Table 7-31 - StaticSessRule Object.....	311
Table 7-32 - PktClass Object.....	315
Table 7-33 - ParamSet Object.....	321
Table 7-34 - ServiceFlow Object.....	332
Table 7-35 - CmtsMacToSrvFlow Object.....	335
Table 7-36 - ServiceFlowSidCluster Object.....	335
Table 7-37 - GrpServiceFlow Object.....	336
Table 7-38 - GrpPktClass Object.....	337
Table 7-39 - CmtsDsid Object.....	337
Table 7-40 - SavCmAuth Object.....	341
Table 7-41 - SavStaticList Object.....	341
Table 7-42 - CmtsCmSavStats Object.....	342
Table 7-43 - CmtsCertRevocationListStatus Object.....	343
Table 7-44 - CpeCtrl Object.....	345
Table 7-45 - CpeIp Object.....	346
Table 7-46 - Grp Object.....	347
Table 7-47 - MdNodeStatus Object.....	350
Table 7-48 - MdDsSgStatus Object.....	351
Table 7-49 - MdUsSgStatus Object.....	351
Table 7-50 - CcapInterfaceIndexMap Object Attributes.....	352
Table 7-51 - EcmgStatus Object Attributes.....	353
Table 7-52 - EcmdStatus Object Attributes.....	354

Table 7-53 - CcapMpegInputProg Object Attributes..... 354

Table 7-54 - CcapMpegOutputProg Object Attributes ..... 355

Table 7-55 - CcapMpegInputProgVideoSession Object Attributes..... 355

Table 7-56 - CcapMpegInputProgVideoSession Object Associations ..... 356

Table 7-57 - CmtsCmRegStatus Object..... 361

Table 7-58 - CmtsCmUsStatus Object..... 365

Table 7-59 - CmtsCmUsOfdmaStatus Object..... 367

Table 7-60 - CmtsCmUsOfdmaProfileStatus Object..... 370

Table 7-61 - CmtsCmDsOfdmStatus Object ..... 371

Table 7-62 - CmtsCmDsOfdmProfileStatus Object ..... 372

Table 7-63 - CmtsCmEmStats Object ..... 372

Table 7-64 - CmtsReplSess Object..... 376

Table 7-65 - IpMulticastStats Object..... 377

Table 7-66 - IpMulticastCpeList Object..... 378

Table 7-67 - IpMulticastBandwidth Object ..... 379

Table 7-68 - ServiceFlowStats Object ..... 380

Table 7-69 - UpstreamStats Object..... 382

Table 7-70 - DynamicServiceStats Object..... 382

Table 7-71 - ServiceFlowLog Object ..... 387

Table 7-72 - UpChCounterExt Object ..... 388

Table 7-73 - ServiceFlowCcfStats Object Attributes ..... 389

Table 7-74 - CmtsIatcProfileStats Object Attributes ..... 390

Table 7-75 - CmtsDebugDsidStats Object..... 391

Table 7-76 - UsOfdmaChannelStatus Object Attributes..... 392

Table 7-77 - UsOfdmaChannelStatus Object Associations ..... 393

Table 7-78 - UsOfdmaSubcarrierType Object Attributes..... 396

Table 7-79 - UsOfdmaChannelDataIucStats Object Attributes ..... 396

Table 7-80 - UsOfdmaChannelDataIucStats Object Associations..... 396

Table 7-81 - UsOfdmaChannelDataIucDetailStatus Object Attributes ..... 397

Table 7-82 - UsOfdmaChannelDataRangingIucStatus Object Attributes..... 398

Table 7-83 - DsOfdmChannelStatus Object Attributes ..... 399

Table 7-84 - DsOfdmChannelStatus Object Associations ..... 400

Table 7-85 - DsOfdmChannelPower Object Attributes ..... 403

Table 7-86- DsOfdmSubcarrierType Object Attributes..... 404

Table 7-87 - DsOfdmProfileStats Object Attributes..... 405

Table 7-88 - DsOfdmProfileStats Object Associations ..... 405

Table 7-89 - DsOfdmSubcarrierStatus Object Attributes ..... 407

Table 7-90 - SignalQualityExt Object ..... 409

Table 7-91 - Data Types ..... 410

Table 7-92 - Format for ImpulseNoiseEventType..... 411

Table 7-93 - PnmCaptureFile Object..... 412

Table 7-94 - PNM Downstream Test..... 412

Table 7-95 - PNM Upstream Tests ..... 413

Table 7-96 - DsOfdmSymbolCapture Object Attributes ..... 415

Table 7-97 - CCAP Symbol Capture File Format .....	416
Table 7-98 - DsOfdmNoisePowerRatio Object Attributes .....	418
Table 7-99 - CmtsUsOfdmaActiveAndQuietProbe Object Attributes.....	420
Table 7-100 - Active and Quiet Probe File Format .....	422
Table 7-101 - UsImpulseNoise Object Attributes .....	423
Table 7-102 - Impulse Noise File Format.....	425
Table 7-103 - UpstreamHistogram Object Attributes.....	426
Table 7-104 - Upstream Histogram File Format.....	428
Table 7-105 - Histogram Bin Centers.....	428
Table 7-106 - UsOfdmaRxPower Object Attributes.....	429
Table 7-107 - UsOfdmaRxMerPerSubcarrier Object Attributes .....	431
Table 7-108 - RxMER File Format .....	432
Table 7-109 - Attributes Required to be Configured for Each Trigger Mode .....	435
Table 7-110 - UsTriggeredSpectrumCaptureCapab Object.....	435
Table 7-111 - UsTriggeredSpectrumCaptureFile Object.....	436
Table 7-112 - UsTriggeredSpectrumCaptureCfg Object .....	438
Table 7-113 - UsTriggeredSpectrumCaptureCtrl Object.....	444
Table 7-114 - UsTriggeredSpectrumCaptureStatus Object .....	445
Table 7-115 - UsTriggeredSpectrumCaptureResult Object.....	445
Table 7-116 - CcapBulkDataControl Object .....	446
Table 7-117 - CcapBulkDataFile Object .....	448
Table 7-118 - Profile Tests .....	450
Table 7-119 - OptReq Attributes .....	451
Table 7-120 - OptMerThresholdCfg Attributes .....	454
Table 7-121 - OptResp Attributes.....	455
Table 7-122 - ProfileChangeCfg Attributes.....	457
Table 8-1 - Subscriber Usage Billing Model Mapping to DOCSIS Management Object .....	462
Table 8-2 - IPDR-related Standards.....	464
Table 8-3 - DOCSIS IPDR Collection Methodologies Sequence Diagram Details.....	474
Table 8-4 - Multisession Streaming Example Sequence Diagram Details .....	476
Table 8-5 - IPDRDoc Element/Attribute Mapping.....	477
Table 8-6 - DOCSIS 3.1 IPDR Service Definitions and Schemas.....	480
Table 9-1 - CMTS Default Event Reporting Mechanism Versus Priority (Non-Volatile Local Log Support Only) .....	494
Table 9-2 - CMTS Default Event Reporting Mechanism Versus Priority (Volatile Local Log Support Only).....	494
Table 9-3 - CMTS Default Event Reporting Mechanism Versus Priority.....	494
Table 9-4 - Event Priorities Assignment.....	495
Table A-1 - MIB Implementation Support .....	498
Table A-2 - SNMP Access Requirements .....	498
Table A-3 - MIB Object Details .....	499
Table C-1 - CMTS Information Attributes .....	565
Table C-2 - Record Information Attributes .....	566
Table C-3 - QoS Information Attributes.....	567
Table C-4 - CPE Information Attributes.....	569
Table C-5 - CMTS Upstream Utilization Information Attributes.....	570

Table C-6 - CMTS Downstream Utilization Information Attributes .....573

Table C-7 - Service Flow Information Attributes .....574

Table C-8 - IP Multicast Information Attributes .....576

Table D-1 - Event Format and Content .....580

Table D-2 - CCAP Events .....601

Table D-3 - Deprecated Events.....604

Table E-1 - Extending CCAP Configuration Objects with the "augment" Statement .....611

Table E-2 - Extending CCAP Configuration Objects with the "deviation" Statement .....612

Table F-1 - General Data Types .....615

Table F-2 - Primitive Data Types .....616

Table F-3 - Extended Data Types .....617

Table F-4 - Derived Data Types .....617

Table G-1 - Data Type Definitions .....620

Table G-2 - LogGlobal Object.....620

Table G-3 - LogTriggersCfg Object.....621

Table G-4 - Log Object .....623

Table G-5 - LogDetail Object.....623

Table V-1 - Sample of Records for the Period 10:30 to 11:00 AM.....682

Table VI-1 - RF Management Statistics available in DOCSIS 3.0.....689

Table VI-2 - Spectrum Analysis Measurement Constructed Graph from collected data.....694

Table VII-1 - ObjectA Example Table Layout .....698

Table VII-2 - Shortened Common Terms .....699

# 1 SCOPE

## 1.1 Introduction and Purpose

This specification is part of the DOCSIS® family of specifications developed by Cable Television Laboratories (CableLabs). In particular, this specification is part of a series of specifications that define the fifth generation of high-speed data-over-cable systems, DOCSIS 3.1. This specification was developed for the benefit of the cable industry, and includes contributions by operators and vendors from North America, Europe, and other regions.

This document defines the requirements necessary for the Configuration, Fault Management, and Performance Management of the Cable Modem Termination System (CMTS) and the Converged Cable Access Platform (CCAP) system. The intent of this specification is to define a common, cross-vendor set of functionality for the configuration and management of CMTSs and CCAPs.

This specification defines a standard configuration object model for the configuration of the CCAP. This specification also defines the SNMP Management requirements for a CCAP. These SNMP requirements include both protocol conformance and management object definitions, based largely upon existing industry standard management objects found in DOCSIS CMTSs and Universal EQAMs. In addition, this specification defines the standard Event Messaging requirements of a CCAP system.

## 1.2 Background

### 1.2.1 Broadband Access Network<sup>1</sup>

A coaxial-based broadband access network is assumed. This may take the form of either an all-coax or hybrid-fiber/coax (HFC) network. The generic term "cable network" is used here to cover all cases.

A cable network uses a tree-and-branch architecture with analog transmission. The key functional characteristics assumed in this document are the following:

- Two-way transmission.
- A maximum optical/electrical spacing between the CMTS and the most distant CM of 100 miles (160 km) in each direction, although typical maximum separation may be 10-15 miles (16-24 km).

---

<sup>1</sup> Modified per CCAP-OSSiv3.1-N-16.1522-2 on 11/15/16 by KB.

## 1.2.2 Network and System Architecture

### 1.2.2.1 The DOCSIS Network

The elements that participate in the provisioning of DOCSIS services are shown in Figure 1-1.

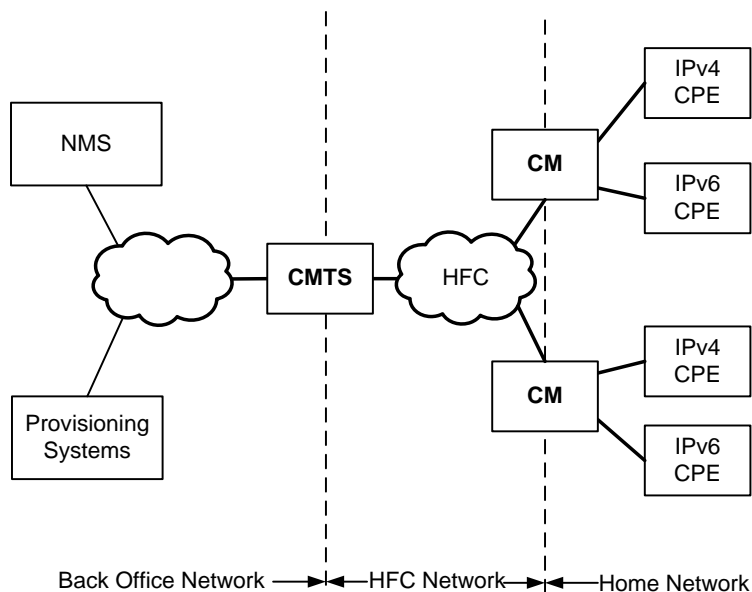

**Figure 1-1 - The DOCSIS Network**

The CM connects to the operator's HFC network and to a home network, bridging packets between them. Many CPEs devices can connect to the CMs' LAN interfaces. CPE devices can be embedded with the CM in a single device, or they can be separate standalone devices (as shown in Figure 1-1). CPE devices may use IPv4, IPv6 or both forms of IP addressing. Examples of typical CPE devices are home routers, set-top devices, and personal computers.

The CMTS connects the operator's back office and core network with the HFC network. Its main function is to forward packets between these two domains, and optionally to forward packets between upstream and downstream channels on the HFC network. The CMTS performs this forwarding with any combination of link-layer (bridging) and network-layer (routing) semantics.

Various applications are used to provide back office configuration and other support to the devices on the DOCSIS network. These applications use IPv4 and/or IPv6 as appropriate to the particular operator's deployment. The following applications include:

- Provisioning Systems
  - The CM provisioning systems are discussed in [CM-OSSv3.1].
  - The Configuration File server is used to download configuration files to CMTSs and CCAPs. Configuration files are in XML format and permit the configuration of the device's provisionable parameters.
  - The Time Protocol server provides Time Protocol clients with the current time of day.
  - Certificate Revocation server provides certificate status.
- Network Management System (NMS)
  - The SNMP Manager allows the operator to configure and monitor SNMP Agents which reside within the CMTSs/CCAPs.

- The syslog server collects messages pertaining to the operation of devices.
- The IPDR Collector server allows the operator to collect bulk statistics in an efficient manner

**1.2.2.2 CMTS Reference Architecture**

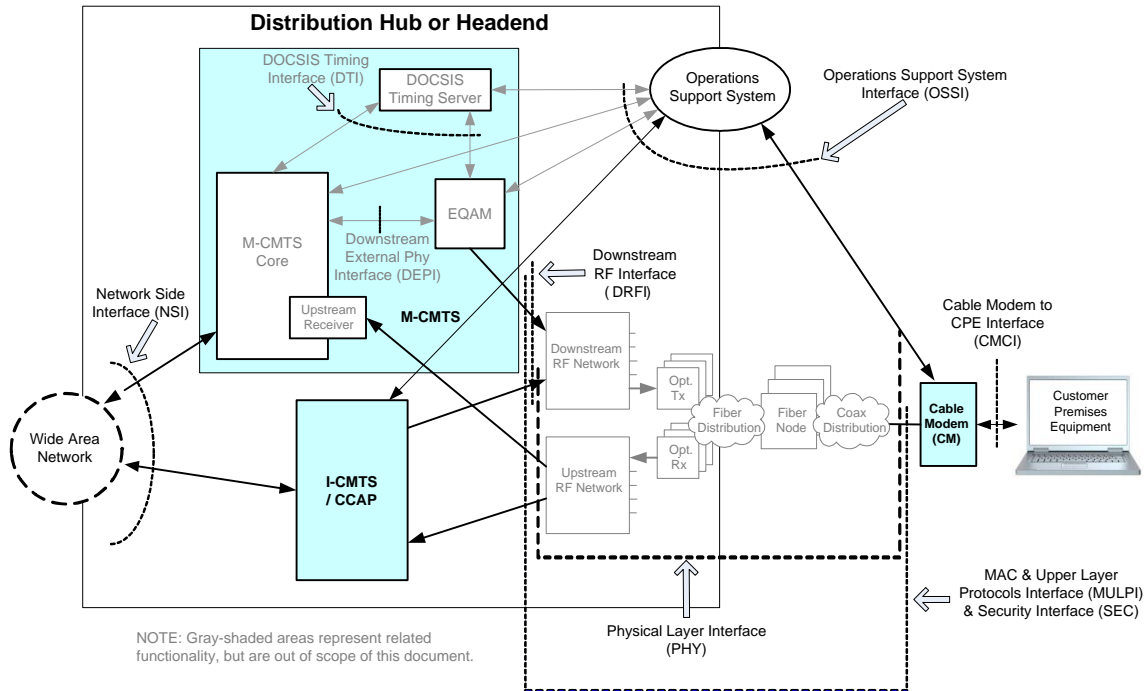

**Figure 1-2 - Data-over-Cable Reference Architecture**

The reference architecture for data-over-cable services and interfaces is shown in Figure 1-2.

**1.2.2.3 CCAP Data Reference Architecture**

The following diagram, Figure 1-3, displays the interfaces used for the CCAP. This specification will focus on the Operations Support System Interface (OSSI) between the CCAP and the Operations Support System (OSS). The interfaces between the OSS and the eSAFE and Cable Modems are out of scope for this specification.

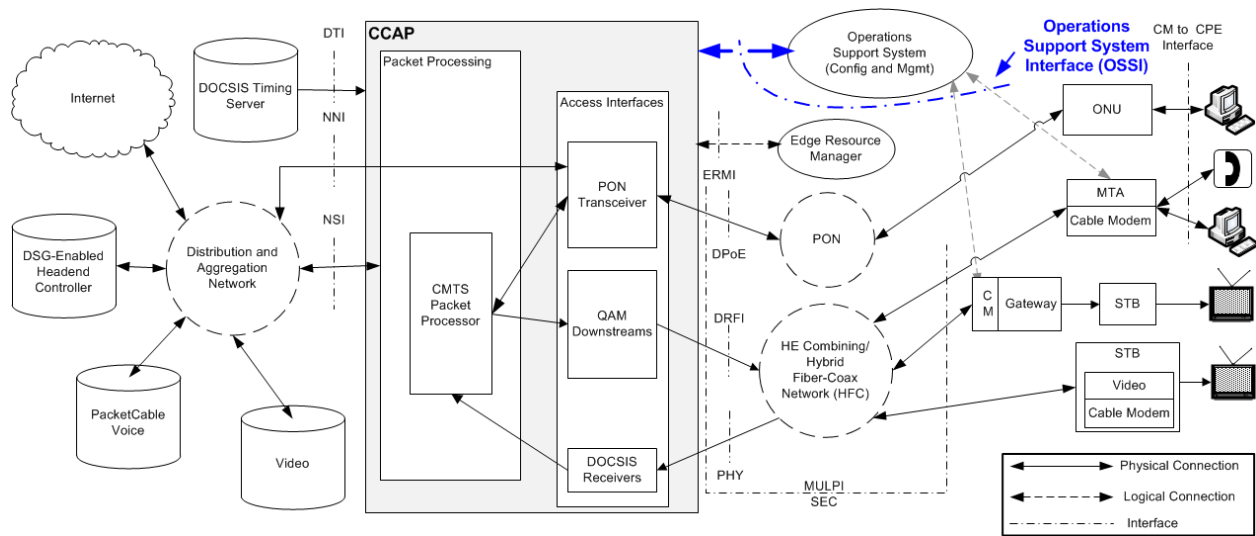

Figure 1-3 - CCAP Interface Reference Architecture

Within a CCAP implementation, logical interface connectivity is from the OSSI to the packet processing function of the CCAP. This logical interface connection allows for the configuration and management of the CCAP infrastructure. The packet processing function will receive its OSS content through the Network Side Interface (NSI), consisting of at least 160 Gbps of data on one or more physical interfaces.

For additional information about the CCAP data reference architecture, see [CCAP TR].

### 1.2.3 Service Goals

As cable operators have widely deployed high-speed data services on cable television systems, the demand for bandwidth has increased. Additionally, networks have scaled to such a degree that IPv4 address constraints are becoming a burden on network operations. To this end, CableLabs' member companies have decided to add new features to the DOCSIS® specification for the purpose of increasing channel capacity, enhancing network security, expanding addressability of network elements, and deploying new service offerings.

The DOCSIS system allows transparent bi-directional transfer of Internet Protocol (IP) traffic, between the cable system headend and customer locations, over an all-coaxial or hybrid-fiber/coax (HFC) cable network. This is shown in simplified form in Figure 1-4.

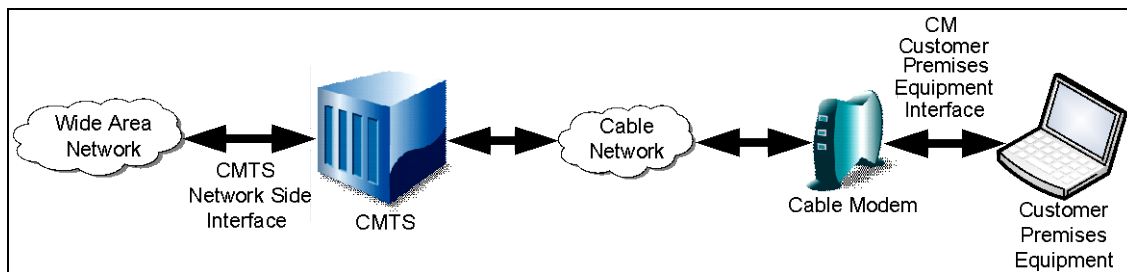

Figure 1-4 - Transparent IP Traffic through the Data-Over-Cable System

### 1.2.4 Statement of Compatibility

This specification defines the DOCSIS 3.1 interface. Prior generations of DOCSIS were commonly referred to as DOCSIS 1.1, 2.0, and 3.0. DOCSIS 3.1 is backward-compatible with equipment built to the previous specifications. DOCSIS 3.1-compliant CMTSs and CCAPs seamlessly support DOCSIS 3.0, DOCSIS 2.0, and DOCSIS 1.1 CMs.



### 1.2.5 DOCSIS 3.1 Documents

A list of the specifications in the DOCSIS 3.1 series is provided in Table 1-1. For further information, please refer to <http://www.cablemodem.com>.

**Table 1-1 - DOCSIS 3.1 Series of Specifications**

Designation	Title
CM-SP-PHYv3.1	Physical Layer Specification
CM-SP-MULPIv3.1	Media Access Control and Upper Layer Protocols Interface Specification
CM-SP-CM-OSSiv3.1	Cable Modem Operations Support System Interface Specification
CM-SP-CCAP-OSSiv3.1	Converged Cable Access Platform Operations Support System Interface Specification
CM-SP-SECv3.1	Security Specification
CM-SP-CMCiv3.0	Cable Modem CPE Interface Specification

This specification is defining the interface for the Operations Support Systems Interface (OSSI), specifically for the Cable Modem Termination System and Converged Cable Access Platform.

## 1.3 Requirements

Throughout this document, the words that are used to define the significance of particular requirements are capitalized. These words are:

"MUST"	This word means that the item is an absolute requirement of this specification.
"MUST NOT"	This phrase means that the item is an absolute prohibition of this specification.
"SHOULD"	This word means that there may exist valid reasons in particular circumstances to ignore this item, but the full implications should be understood and the case carefully weighed before choosing a different course.
"SHOULD NOT"	This phrase means that there may exist valid reasons in particular circumstances when the listed behavior is acceptable or even useful, but the full implications should be understood and the case carefully weighed before implementing any behavior described with this label.
"MAY"	This word means that this item is truly optional. One vendor may choose to include the item because a particular marketplace requires it or because it enhances the product, for example; another vendor may omit the same item.

This document defines many features and parameters, and a valid range for each parameter is usually specified. Equipment (CMTS and CCAP) requirements are always explicitly stated. Equipment complying with all mandatory (MUST and MUST NOT) requirements are considered compliant with this specification. Support of non-mandatory features and parameter values is optional.

## 1.4 Conventions

In this specification the following convention applies any time a bit field is displayed in a figure. The bit field should be interpreted by reading the figure from left to right, then from top to bottom, with the MSB being the first bit so read and the LSB being the last bit so read.

MIB syntax, XML Schema and YANG module syntax are represented by this code sample font.

**NOTE:** Notices and/or Warnings are identified by this style font and label.

## 1.5 Organization of Document<sup>2</sup>

Section 1 provides an overview of the DOCSIS 3.1 CCAP/CMTS specification including the reference architecture and statement of compatibility.

Section 2 includes a list of normative and informative references used within this specification.

Section 3 defines the terms used throughout this specification.

Section 4 defines the acronyms and XML namespaces used throughout this specification.

Section 5 provides an introduction to the FCAPS Network Management Model, which forms the organizational structure of this specification. In order to provide a more logical flow, one that mirrors processes in place at MSOs, the order of functions has been shifted, and is organized as CPAF:

- Configuration Management
- Performance Management
- Accounting Management
- Fault Management

Note that Security Management topics are covered in context of these topics.

Key feature and Use Cases for each management function are provided along with a high-level CCAP management architectural view. An introduction to the concept of Information Models and Data Models is also provided.

Section 6 defines the Configuration Management functions of the CCAP, including theory of operation, network management protocols and Information Models.

Section 7 defines the Performance Management functions of the CCAP, including network management protocols, Information Models and Data Model requirements.

Section 8 defines the Accounting Management functions of the CCAP, including IPDR network management protocols, SAMIS and Data Model requirements.

Section 9 defines the Fault Management functions of the CCAP including network management protocols, event reporting requirements and Information Models.

### 1.5.1 Annexes (Normative)

Annex A includes a detailed list of MIB object requirements for the CMTS and CCAP.

Annex B describes the IPDR for DOCSIS Cable Data Systems Subscriber Usage Billing Records.

Annex C describes the Auxiliary Schemas for DOCSIS IPDR Service Definitions.

Annex D describes the format and content for Event, SYSLOG, and SNMP Notification.

Annex E describes how vendors can extend the configuration data model.

Annex F describes the CCAP Data Type Definitions used in both the Information Models and data models.

Annex G describes the Diagnostic Log network management feature including Information Models.

### 1.5.2 Appendices (Informative)

Appendix I contains a sample CCAP XML Configuration.

Appendix II contains a method for identifying replicated QAMs.

Appendix III describes the vendor schema versioning in the CCAP XSD.

Appendix IV describes the process of converting YANG to XSD.

---

<sup>2</sup> Modified per CCAP-OSSv3.1-N-16.1643-2 on 12/8/16 by KB.

Appendix V contains DOCSIS IPDR sample instance documents.

Appendix VI contains spectrum analysis use cases.

Appendix VII describes the Unified Modeling Language (UML) notation used in defining Information Models.

Appendix VIII lists the acknowledgments for authoring this specification.

Appendix IX contains the revision history.

## 2 REFERENCES

### 2.1 Normative References<sup>3</sup>

In order to claim compliance with this specification, it is necessary to conform to the following standards and other works as indicated, in addition to the other requirements of this specification. Notwithstanding, intellectual property rights may be required to use or implement such normative references.

[CANN]	CableLabs Assigned Names and Numbers, CL-SP-CANN-I15-170111, January 11, 2017, Cable Television Laboratories, Inc.
[CCAP-CONFIG-YANG]	CCAP YANG Configuration Module, <a href="http://www.cablelabs.com/YANG/DOCSIS/3.1">http://www.cablelabs.com/YANG/DOCSIS/3.1</a>
[CCAP-EVENTS-YANG]	CCAP YANG Module for Event Messaging, CCAPevents.yang, <a href="http://www.cablelabs.com/YANG/DOCSIS">http://www.cablelabs.com/YANG/DOCSIS</a>
[CCAP-MIB]	Converged Cable Access Platform MIB, CCAP-MIB, <a href="http://www.cablelabs.com/MIBs/DOCSIS/">http://www.cablelabs.com/MIBs/DOCSIS/</a> .
[CLAB-DEF-MIB]	CableLabs Definition MIB Specification, CL-SP-MIB-CLABDEF-I12-160325, March 25, 2016, Cable Television Laboratories, Inc.
[CLAB-TOPO-MIB]	CableLabs Topology MIB, CLAB-TOPO-MIB, <a href="http://www.cablelabs.com/MIBs/common/">http://www.cablelabs.com/MIBs/common/</a> .
[CM-OSSv3.1]	DOCSIS 3.1 Cable Modem OSSI Specification, CM-SP-CM-OSSv3.1-I08-170111, January 11, 2017, Cable Television Laboratories, Inc.
[DOCS-DIAG-MIB]	DOCSIS Diagnostic Log MIB, DOCS-DIAG-MIB, <a href="http://www.cablelabs.com/MIBs/DOCSIS/">http://www.cablelabs.com/MIBs/DOCSIS/</a> .
[DOCS-IF3-MIB]	DOCSIS Interface 3 MIB Module, DOCS-IF3-MIB, <a href="http://www.cablelabs.com/MIBs/DOCSIS/">http://www.cablelabs.com/MIBs/DOCSIS/</a> .
[DOCS-IF31-MIB]	DOCSIS Interface 3.1 MIB Module, DOCS-IF31-MIB, <a href="http://www.cablelabs.com/MIBs/DOCSIS/">http://www.cablelabs.com/MIBs/DOCSIS/</a> .
[DOCS-IFEXT2-MIB]	DOCSIS Interface Extension 2 MIB Module, DOCS-IFEXT2-MIB, <a href="http://www.cablelabs.com/MIBs/DOCSIS/">http://www.cablelabs.com/MIBs/DOCSIS/</a> .
[DOCS-LOADBAL3-MIB]	DOCSIS Load Balancing 3 MIB Module, DOCS-LOADBAL3-MIB, <a href="http://www.cablelabs.com/MIBs/DOCSIS/">http://www.cablelabs.com/MIBs/DOCSIS/</a> .
[DOCS-MCAST-AUTH-MIB]	DOCSIS Multicast Authorization MIB Module, DOCS-MCAST-AUTH-MIB, <a href="http://www.cablelabs.com/MIBs/DOCSIS/">http://www.cablelabs.com/MIBs/DOCSIS/</a> .
[DOCS-MCAST-MIB]	DOCSIS Multicast MIB Module, DOCS-MCAST-MIB, <a href="http://www.cablelabs.com/MIBs/DOCSIS/">http://www.cablelabs.com/MIBs/DOCSIS/</a> .
[DOCS-PNM-MIB]	DOCSIS PNM MIB Module, DOCS-PNM-MIB, <a href="http://www.cablelabs.com/MIBs/DOCSIS/">http://www.cablelabs.com/MIBs/DOCSIS/</a> .
[DOCS-QOS3-MIB]	DOCSIS Quality of Service 3 MIB Module, DOCS-QOS3-MIB, <a href="http://www.cablelabs.com/MIBs/DOCSIS/">http://www.cablelabs.com/MIBs/DOCSIS/</a> .
[DOCS-SEC-MIB]	DOCSIS Security MIB, DOCS-SEC-MIB, <a href="http://www.cablelabs.com/MIBs/DOCSIS/">http://www.cablelabs.com/MIBs/DOCSIS/</a> .
[DOCS-SUBMGT3-MIB]	DOCSIS Subscriber Management 3 MIB, DOCS-SUBMGT3-MIB, <a href="http://www.cablelabs.com/MIBs/DOCSIS/">http://www.cablelabs.com/MIBs/DOCSIS/</a> .
[DOCSIS-CM]	DOCSIS CM Information Schema, DOCSIS-CM_3.5.1-A.3.xsd, <a href="http://www.cablelabs.com/namespaces/DOCSIS/3.0/xsd/ipdr/DOCSIS-CM">http://www.cablelabs.com/namespaces/DOCSIS/3.0/xsd/ipdr/DOCSIS-CM</a>

---

<sup>3</sup> Modified per CCAP-OSSv3.1-N-15.1248-1 on 3/5/15 by KB, per CCAP-OSSv3.1-N-15.1307-3 on 6/1/15 by KB; per CCAP-OSSv3.1-N-15.1349-3 on 8/13/15 by KB; per CCAP-OSSv3.1-N-15.1390-2 on 11/11/15 by KB.

[DOCSIS-CMTS]	DOCSIS CMTS Information Schema, DOCSIS-CMTS_3.5.1-A.1.xsd, <a href="http://www.cablelabs.com/namespaces/DOCSIS/3.0/xsd/ipdr/DOCSIS-CMTS">http://www.cablelabs.com/namespaces/DOCSIS/3.0/xsd/ipdr/DOCSIS-CMTS</a>
[DOCSIS-CMTS-CM-DS-OFDM]	DOCSIS CMTS CM Downstream OFDM Information Schema, DOCSIS-CMTS-CM-DS-OFDM_3.5.1-B.1.xsd, <a href="http://www.cablelabs.com/namespaces/DOCSIS/3.1/xsd/ipdr/DOCSIS-CMTS-CM-DS-OFDM">http://www.cablelabs.com/namespaces/DOCSIS/3.1/xsd/ipdr/DOCSIS-CMTS-CM-DS-OFDM</a>
[DOCSIS-CMTS-CM-DS-OFDM-PROFILE-TYPE]	DOCSIS CMTS CM Downstream OFDM Profile Status Type Schema, DOCSIS-CMTS-CM-DS-OFDM-PROFILE-STATUS-TYPE_3.5.1-B.1.xsd, <a href="http://www.cablelabs.com/namespaces/DOCSIS/3.1/xsd/ipdr/DOCSIS-CMTS-CM-DS-OFDM-PROFILE-STATUS-TYPE">http://www.cablelabs.com/namespaces/DOCSIS/3.1/xsd/ipdr/DOCSIS-CMTS-CM-DS-OFDM-PROFILE-STATUS-TYPE</a>
[DOCSIS-CMTS-CM-DS-OFDM-STATUS-TYPE]	DOCSIS CMTS CM Downstream OFDM Status Type Schema, DOCSIS-CMTS-CM-DS-OFDM-STATUS-TYPE_3.5.1-B.1.xsd, <a href="http://www.cablelabs.com/namespaces/DOCSIS/3.1/xsd/ipdr/DOCSIS-CMTS-CM-DS-OFDM-STATUS-TYPE">http://www.cablelabs.com/namespaces/DOCSIS/3.1/xsd/ipdr/DOCSIS-CMTS-CM-DS-OFDM-STATUS-TYPE</a>
[DOCSIS-CMTS-CM-NODE-CH]	DOCSIS CMTS CM Node Channel Information Schema, DOCSIS-CMTS-CM-NODE-CH_3.5.1-A.2.xsd, <a href="http://www.cablelabs.com/namespaces/DOCSIS/3.0/xsd/ipdr/DOCSIS-CMTS-CM-NODE-CH">http://www.cablelabs.com/namespaces/DOCSIS/3.0/xsd/ipdr/DOCSIS-CMTS-CM-NODE-CH</a>
[DOCSIS-CMTS-CM-PARTIAL]	DOCSIS CMTS CM Partial Service/Channel Information Schema, DOCSIS-CMTS-CM-PARTIAL_3.5.1-B.1.xsd, <a href="http://www.cablelabs.com/namespaces/DOCSIS/3.1/xsd/ipdr/DOCSIS-CMTS-CM-PARTIAL">http://www.cablelabs.com/namespaces/DOCSIS/3.1/xsd/ipdr/DOCSIS-CMTS-CM-PARTIAL</a>
[DOCSIS-CMTS-CM-REG-STATUS-TYPE]	DOCSIS CMTS CM Registration Status Type Schema, DOCSIS-CMTS-CM-REG-STATUS-TYPE_3.5.1-B.1.xsd, <a href="http://www.cablelabs.com/namespaces/DOCSIS/3.1/xsd/ipdr/DOCSIS-CMTS-CM-REG-STATUS-TYPE">http://www.cablelabs.com/namespaces/DOCSIS/3.1/xsd/ipdr/DOCSIS-CMTS-CM-REG-STATUS-TYPE</a>
[DOCSIS-CMTS-CM-SERVICE-FLOW-TYPE]	DOCSIS CMTS CM Service Flow Type Schema, DOCSIS-CMTS-CM-SERVICE-FLOW-TYPE_3.5.1-B.1.xsd, <a href="http://www.cablelabs.com/namespaces/DOCSIS/3.1/xsd/ipdr/DOCSIS-CMTS-CM-SERVICE-FLOW-TYPE">http://www.cablelabs.com/namespaces/DOCSIS/3.1/xsd/ipdr/DOCSIS-CMTS-CM-SERVICE-FLOW-TYPE</a>
[DOCSIS-CMTS-CM-US]	DOCSIS CMTS CM Upstream Information Schema, DOCSIS-CMTS-CM-US_3.5.1-A.3.xsd, <a href="http://www.cablelabs.com/namespaces/DOCSIS/3.0/xsd/ipdr/DOCSIS-CMTS-CM-US">http://www.cablelabs.com/namespaces/DOCSIS/3.0/xsd/ipdr/DOCSIS-CMTS-CM-US</a>
[DOCSIS-CMTS-CM-US-OFDMA]	DOCSIS CMTS CM Upstream OFDMA Information Schema, DOCSIS-CMTS-CM-US-OFDMA_3.5.1-B.1.xsd, <a href="http://www.cablelabs.com/namespaces/DOCSIS/3.1/xsd/ipdr/DOCSIS-CMTS-CM-US-OFDMA">http://www.cablelabs.com/namespaces/DOCSIS/3.1/xsd/ipdr/DOCSIS-CMTS-CM-US-OFDMA</a>
[DOCSIS-CMTS-CM-US-OFDMA-PROFILE-TYPE]	DOCSIS CMTS CM Upstream OFDMA Profile Status Type Schema, DOCSIS-CMTS-CM-US-OFDMA-PROFILE-STATUS-TYPE_3.5.1-B.1.xsd, <a href="http://www.cablelabs.com/namespaces/DOCSIS/3.1/xsd/ipdr/DOCSIS-CMTS-CM-US-OFDMA-PROFILE-STATUS-TYPE">http://www.cablelabs.com/namespaces/DOCSIS/3.1/xsd/ipdr/DOCSIS-CMTS-CM-US-OFDMA-PROFILE-STATUS-TYPE</a>
[DOCSIS-CMTS-CM-US-OFDMA-STATUS-TYPE]	DOCSIS CMTS CM Upstream OFDMA Status Type Schema, DOCSIS-CMTS-CM-US-OFDMA-STATUS-TYPE_3.5.1-B.1.xsd, <a href="http://www.cablelabs.com/namespaces/DOCSIS/3.1/xsd/ipdr/DOCSIS-CMTS-CM-US-OFDMA-STATUS-TYPE">http://www.cablelabs.com/namespaces/DOCSIS/3.1/xsd/ipdr/DOCSIS-CMTS-CM-US-OFDMA-STATUS-TYPE</a>
[DOCSIS-CMTS-CM-US-STATS-TYPE]	DOCSIS CMTS CM Upstream Status Schema, DOCSIS-CMTS-CM-US-STATS-TYPE_3.5.1-A.2.xsd, <a href="http://www.cablelabs.com/namespaces/DOCSIS/3.0/xsd/ipdr/DOCSIS-CMTS-CM-US-STATS-TYPE">http://www.cablelabs.com/namespaces/DOCSIS/3.0/xsd/ipdr/DOCSIS-CMTS-CM-US-STATS-TYPE</a>
[DOCSIS-CMTS-DS-UTIL]	DOCSIS CMTS Downstream Utilization Information Schema, DOCSIS-CMTS-DS-UTIL_3.5.1-A.3.xsd, <a href="http://www.cablelabs.com/namespaces/DOCSIS/3.0/xsd/ipdr/DOCSIS-CMTS-DS-UTIL">http://www.cablelabs.com/namespaces/DOCSIS/3.0/xsd/ipdr/DOCSIS-CMTS-DS-UTIL</a>
[DOCSIS-CMTS-DS-UTIL-STATS-TYPE]	DOCSIS CMTS Downstream Utilization Status Schema, DOCSIS-CMTS-DS-UTIL-STATS-TYPE_3.5.1-A.3.xsd, <a href="http://www.cablelabs.com/namespaces/DOCSIS/3.0/xsd/ipdr/DOCSIS-CMTS-DS-UTIL-STATS-TYPE">http://www.cablelabs.com/namespaces/DOCSIS/3.0/xsd/ipdr/DOCSIS-CMTS-DS-UTIL-STATS-TYPE</a>

[DOCSIS-CMTS-TOPOLOGY-TYPE]	DOCSIS CMTS Topology Type Schema, DOCSIS-CMTS-TOPOLOGY-TYPE_3.5.1-A.2.xsd, <a href="http://www.cablelabs.com/namespaces/DOCSIS/3.0/xsd/ipdr/DOCSIS-CMTS-TOPOLOGY-TYPE">http://www.cablelabs.com/namespaces/DOCSIS/3.0/xsd/ipdr/DOCSIS-CMTS-TOPOLOGY-TYPE</a>
[DOCSIS-CMTS-US-UTIL]	DOCSIS CMTS Upstream Utilization Schema, DOCSIS-CMTS-US-UTIL_3.5.1-A.3.xsd, <a href="http://www.cablelabs.com/namespaces/DOCSIS/3.0/xsd/ipdr/DOCSIS-CMTS-US-UTIL">http://www.cablelabs.com/namespaces/DOCSIS/3.0/xsd/ipdr/DOCSIS-CMTS-US-UTIL</a>
[DOCSIS-CMTS-US-UTIL-STATS-TYPE]	DOCSIS CMTS Upstream Utilization Status Schema, DOCSIS-CMTS-US-UTIL-STATS-TYPE_3.5.1-A.4.xsd, <a href="http://www.cablelabs.com/namespaces/DOCSIS/3.0/xsd/ipdr/DOCSIS-CMTS-US-UTIL-STATS-TYPE">http://www.cablelabs.com/namespaces/DOCSIS/3.0/xsd/ipdr/DOCSIS-CMTS-US-UTIL-STATS-TYPE</a>
[DOCSIS-CPE]	DOCSIS CPE Information Schema, DOCSIS-CPE_3.5.1-A.2.xsd, <a href="http://www.cablelabs.com/namespaces/DOCSIS/3.0/xsd/ipdr/DOCSIS-CPE">http://www.cablelabs.com/namespaces/DOCSIS/3.0/xsd/ipdr/DOCSIS-CPE</a>
[DOCSIS-CPE-TYPE]	DOCSIS CPE Type Schema, DOCSIS-CPE-TYPE_3.5.1-A.2.xsd, <a href="http://www.cablelabs.com/namespaces/DOCSIS/3.0/xsd/ipdr/DOCSIS-CPE-TYPE">http://www.cablelabs.com/namespaces/DOCSIS/3.0/xsd/ipdr/DOCSIS-CPE-TYPE</a>
[DOCSIS-DIAG-LOG]	DOCSIS Diagnostic Log Information Schema, DOCSIS-DIAG-LOG_3.5.1-A.1.xsd, <a href="http://www.cablelabs.com/namespaces/DOCSIS/3.0/xsd/ipdr/DOCSIS-DIAG-LOG">http://www.cablelabs.com/namespaces/DOCSIS/3.0/xsd/ipdr/DOCSIS-DIAG-LOG</a>
[DOCSIS-DIAG-LOG-DETAIL]	DOCSIS Diagnostic Log Detail Schema, DOCSIS-DIAG-LOG-DETAIL_3.5.1-A.1.xsd, <a href="http://www.cablelabs.com/namespaces/DOCSIS/3.0/xsd/ipdr/DOCSIS-DIAG-LOG-DETAIL">http://www.cablelabs.com/namespaces/DOCSIS/3.0/xsd/ipdr/DOCSIS-DIAG-LOG-DETAIL</a>
[DOCSIS-DIAG-LOG-DETAIL-TYPE]	DOCSIS Diagnostic Log Detail Type Schema, DOCSIS-DIAG-LOG-DETAIL-TYPE_3.5.1-A.2.xsd, <a href="http://www.cablelabs.com/namespaces/DOCSIS/3.0/xsd/ipdr/DOCSIS-DIAG-LOG-DETAIL-TYPE">http://www.cablelabs.com/namespaces/DOCSIS/3.0/xsd/ipdr/DOCSIS-DIAG-LOG-DETAIL-TYPE</a>
[DOCSIS-DIAG-LOG-EVENT-TYPE]	DOCSIS Diagnostic Log Event Type Schema, DOCSIS-DIAG-LOG-EVENT-TYPE_3.5.1-A.2.xsd, <a href="http://www.cablelabs.com/namespaces/DOCSIS/3.0/xsd/ipdr/DOCSIS-DIAG-LOG-EVENT-TYPE">http://www.cablelabs.com/namespaces/DOCSIS/3.0/xsd/ipdr/DOCSIS-DIAG-LOG-EVENT-TYPE</a>
[DOCSIS-DIAG-LOG-TYPE]	DOCSIS Diagnostic Log Type Schema, DOCSIS-DIAG-LOG-TYPE_3.5.1-A.2.xsd, <a href="http://www.cablelabs.com/namespaces/DOCSIS/3.0/xsd/ipdr/DOCSIS-DIAG-LOG-TYPE">http://www.cablelabs.com/namespaces/DOCSIS/3.0/xsd/ipdr/DOCSIS-DIAG-LOG-TYPE</a>
[DOCSIS-DS-OFDM-PROFILE-STATS-TYPE]	DOCSIS Downstream OFDM Profile Stats Type Schema, DOCSIS-DS-OFDM-PROFILE-STATS-TYPE_3.5.1-B.1.xsd, <a href="http://www.cablelabs.com/namespaces/DOCSIS/3.1/xsd/ipdr/DOCSIS-DS-OFDM-PROFILE-STATS-TYPE">http://www.cablelabs.com/namespaces/DOCSIS/3.1/xsd/ipdr/DOCSIS-DS-OFDM-PROFILE-STATS-TYPE</a>
[DOCSIS-IP-MULTICAST]	DOCSIS IP Multicast Information Schema, DOCSIS-IP-MULTICAST_3.5.1-A.1.xsd, <a href="http://www.cablelabs.com/namespaces/DOCSIS/3.0/xsd/ipdr/DOCSIS-IP-MULTICAST">http://www.cablelabs.com/namespaces/DOCSIS/3.0/xsd/ipdr/DOCSIS-IP-MULTICAST</a>
[DOCSIS-IP-MULTICAST-STATS-TYPE]	DOCSIS IP Multicast Statistics Type Schema, DOCSIS-IP-MULTICAST-STATS-TYPE_3.5.1-A.1.xsd, <a href="http://www.cablelabs.com/namespaces/DOCSIS/3.0/xsd/ipdr/DOCSIS-IP-MULTICAST-STATS-TYPE">http://www.cablelabs.com/namespaces/DOCSIS/3.0/xsd/ipdr/DOCSIS-IP-MULTICAST-STATS-TYPE</a>
[DOCSIS-MD-NODE]	DOCSIS MAC Domain Node Information Schema, DOCSIS-MD-NODE_3.5.1-A.2.xsd, <a href="http://www.cablelabs.com/namespaces/DOCSIS/3.0/xsd/ipdr/DOCSIS-MD-NODE">http://www.cablelabs.com/namespaces/DOCSIS/3.0/xsd/ipdr/DOCSIS-MD-NODE</a>
[DOCSIS-OFDM-PROFILE]	DOCSIS OFDM Profile Information Schema, DOCSIS-OFDM-PROFILE_3.5.1-B.1.xsd, <a href="http://www.cablelabs.com/namespaces/DOCSIS/3.1/xsd/ipdr/DOCSIS-OFDM-PROFILE">http://www.cablelabs.com/namespaces/DOCSIS/3.1/xsd/ipdr/DOCSIS-OFDM-PROFILE</a>
[DOCSIS-QOS]	DOCSIS QoS Information Schema, DOCSIS-QOS_3.5.1-A.1.xsd, <a href="http://www.cablelabs.com/namespaces/DOCSIS/3.0/xsd/ipdr/DOCSIS-QOS">http://www.cablelabs.com/namespaces/DOCSIS/3.0/xsd/ipdr/DOCSIS-QOS</a>
[DOCSIS-REC]	DOCSIS Record Information Schema, DOCSIS-REC_3.5.1-A.1.xsd, <a href="http://www.cablelabs.com/namespaces/DOCSIS/3.0/xsd/ipdr/DOCSIS-REC">http://www.cablelabs.com/namespaces/DOCSIS/3.0/xsd/ipdr/DOCSIS-REC</a>
[DOCSIS-SAMIS-TYPE-1]	DOCSIS SAMIS Type 1 Schema, DOCSIS-SAMIS-TYPE-1_3.5.1-A.1.xsd, <a href="http://www.cablelabs.com/namespaces/DOCSIS/3.0/xsd/ipdr/DOCSIS-SAMIS-TYPE-1">http://www.cablelabs.com/namespaces/DOCSIS/3.0/xsd/ipdr/DOCSIS-SAMIS-TYPE-1</a>
[DOCSIS-SAMIS-TYPE-2]	DOCSIS SAMIS Type 2 Schema, DOCSIS-SAMIS-TYPE-2_3.5.1-A.1.xsd, <a href="http://www.cablelabs.com/namespaces/DOCSIS/3.0/xsd/ipdr/DOCSIS-SAMIS-TYPE-2">http://www.cablelabs.com/namespaces/DOCSIS/3.0/xsd/ipdr/DOCSIS-SAMIS-TYPE-2</a>

[DOCSIS-SERVICE-FLOW]	DOCSIS Service Flow Information Schema, DOCSIS-SERVICE-FLOW_3.5.1-B.1.xsd, <a href="http://www.cablelabs.com/namespaces/DOCSIS/3.1/xsd/ipdr/DOCSIS-SERVICE-FLOW">http://www.cablelabs.com/namespaces/DOCSIS/3.1/xsd/ipdr/DOCSIS-SERVICE-FLOW</a> .
[DOCSIS-SPECTRUM]	DOCSIS Spectrum Measurement Information Schema, DOCSIS-SPECTRUM_3.5.1-A.2.xsd, <a href="http://www.cablelabs.com/namespaces/DOCSIS/3.0/xsd/ipdr/DOCSIS-SPECTRUM/">http://www.cablelabs.com/namespaces/DOCSIS/3.0/xsd/ipdr/DOCSIS-SPECTRUM/</a>
[DOCSIS-SPECTRUM-MEASUREMENT-TYPE]	DOCSIS Spectrum Measurement Type Schema, DOCSIS-SPECTRUM-MEASUREMENT-TYPE_3.5.1-A.2.xsd, <a href="http://www.cablelabs.com/namespaces/DOCSIS/3.0/xsd/ipdr/DOCSIS-SPECTRUM-MEASUREMENT-TYPE">http://www.cablelabs.com/namespaces/DOCSIS/3.0/xsd/ipdr/DOCSIS-SPECTRUM-MEASUREMENT-TYPE</a> .
[DOCSIS-US-OFDMA-PROFILE-STATS-TYPE]	DOCSIS Upstream OFDMA Profile Stats Type, DOCSIS-US-OFDMA-PROFILE-STATS-TYPE_3.5.1-B.1.xsd, <a href="http://www.cablelabs.com/namespaces/DOCSIS/3.1/xsd/ipdr/DOCSIS-US-OFDMA-PROFILE-STATS-TYPE">http://www.cablelabs.com/namespaces/DOCSIS/3.1/xsd/ipdr/DOCSIS-US-OFDMA-PROFILE-STATS-TYPE</a>
[DPoE OSSIV1.0]	DOCSIS Provisioning of EPON OSSI Specification, DPoE-SP-OSSIV1.0-I08-140807, August 7, 2014, Cable Television Laboratories, Inc.
[DPoE OSSIV2.0]	DOCSIS Provisioning of EPON OSSI Specification, DPoE-SP-OSSIV2.0-I10-170111, January 11, 2017, Cable Television Laboratories, Inc.
[eDOCSIS]	eDOCSIS Specification, CM-SP-eDOCSIS-I28-150305, March 5, 2015, Cable Television Laboratories, Inc.
[IPDR/BSR]	IPDR Business Solution Requirements - Network Data Management Usage (NDM-U), Version 3.7, TM Forum, October 2009.
[IPDR/CAPAB]	IPDR/Capability File Format, Version 3.9, TM Forum, October 2009.
[IPDR/SP]	IPDR Streaming Protocol (IPDR/SP) Specification, TMF8000-IPDR-IIS-PS, Version 2.7, TM Forum, November 2011.
[IPDR/SSDG]	IPDR Service Specification Design Guide, Version 3.8, TM Forum, October 2009.
[IPDR/XDR]	IPDR/XDR File Encoding Format, Version 3.5.1, TM Forum, October 2009.
[L2VPN]	Business Services over DOCSIS: Layer 2 Virtual Private Networks, CM-SP-L2VPN-I15-150528, May 28, 2015, Cable Television Laboratories, Inc.
[M-OSSI]	DOCSIS M-CMTS Operations Support Interface, CM-SP-M-OSSI-I08-081209, December 9, 2008, Cable Television Laboratories, Inc.
[MPEG]	Information technology - Generic coding of moving pictures and associated audio information: Systems, ISO/IEC 13818-1: 2007.
[MULPIv3.0]	MAC and Upper Layer Protocols Interface Specification, CM-SP-MULPIv3.0-I30-170111, January 11, 2017, Cable Television Laboratories, Inc.
[MULPIv3.1]	MAC and Upper Layer Protocols Interface Specification, CM-SP-MULPIv3.1-I10-170111, January 11, 2017, Cable Television Laboratories, Inc.
[OSSIV3.0]	Operations Support System Interface Specification, CM-SP-OSSIV3.0-I31-170111, January 11, 2017, Cable Television Laboratories, Inc.
[PCMM]	PacketCable Multimedia Specification, PKT-SP-MM-I07-151110, November 10, 2015, Cable Television Laboratories, Inc.
[PHYv3.1]	DOCSIS Physical Layer Specification, CM-SP-PHYv3.1-I10-170111, January 11, 2017, Cable Television Laboratories, Inc.
[PKT-DQOS]	PacketCable Dynamic Quality of Service Specification, PKT-SP-DQOS-C01-071129, November 29, 2007, Cable Television Laboratories, Inc.
[PORT NUMS]	Port Numbers, IANA, <a href="http://www.iana.org/assignments/port-numbers">http://www.iana.org/assignments/port-numbers</a> .
[RFC 1112]	IETF RFC 1112, Host Extensions for IP Multicasting, August 1989.

- [RFC 1350] IETF RFC 1350/STD0033, The TFTP Protocol (Revision 2), July 1992.
- [RFC 1832] IETF RFC 1832, XDR: External Data Representation Standard, August 1995.
- [RFC 2133] IETF RFC 2133, Basic Socket Interface Extensions for IPv6, April 1997.
- [RFC 2236] IETF RFC 2236, Internet Group Management Protocol, Version 2, November 1997.
- [RFC 2348] IETF RFC 2348, TFTP Blocksize Option, May 1998.
- [RFC 2460] IETF RFC 2460, Internet Protocol, Version 6 (IPv6), December 1998.
- [RFC 2464] IETF RFC 2464, Transmission of IPv6 Packets over Ethernet Networks, December 1998.
- [RFC 2560] IETF RFC 2560, X.509 Internet Public Key Infrastructure Online Certification Status Protocol - OCSP, June 1999.
- [RFC 2573] IETF RFC 2786, SNMP Applications, April 1999.
- [RFC 2575] IETF RFC 2575, View-based Access Control Model (VACM) for the Simple Network Management Protocol (SNMP), April 1999.
- [RFC 2578] IETF RFC 2578, Structure of Management Information Version 2 (SMIv2), April 1999.
- [RFC 2669] IETF RFC 2669, DOCSIS Cable Device MIB Cable Device Management Information Base for DOCSIS compliant Cable Modems and Cable Modem Termination Systems, August 1999.
- [RFC 2710] IETF RFC 2710, Multicast Listener Discovery (MLD) for IPv6, October 1999.
- [RFC 2786] IETF RFC 2786, Diffie-Helman USM Key Management, March 2000.
- [RFC 2790] IETF RFC 2790, Host Resources MIB, March 2000.
- [RFC 2821] IETF RFC 2821, Simple Mail Transfer Protocol, April 2001.
- [RFC 2856] IETF RFC 2856, Textual Conventions for Additional High Capacity Data Types, June 2000.
- [RFC 2863] IETF RFC 2863, The Interfaces Group MIB, June 2000.
- [RFC 2933] IETF RFC 2933, Internet Group Management Protocol MIB, October 2000.
- [RFC 3019] IETF RFC 3019, IP Version 6 Management Information Base for the Multicast Listener Discovery Protocol, January 2001.
- [RFC 3083] IETF RFC 3083, Baseline Privacy Interface Management Information Base for DOCSIS Compliant Cable Modems and Cable Modem Termination Systems, March 2001.
- [RFC 3164] IETF RFC 3164, The BSD Syslog Protocol, August 2001.
- [RFC 3289] IETF RFC 3289, Management Information Base for the Differentiated Services Architecture, June 2002.
- [RFC 3306] IETF RFC 3306, Unicast-Prefix-based IPv6 Multicast Addresses, August 2002.
- [RFC 3376] IETF RFC 3376, Internet Group Management Protocol, Version 3, October 2002.
- [RFC 3412] IETF RFC 3412, Message Processing and Dispatching for the Simple Network Management Protocol (SNMP), December 2002.
- [RFC 3418] IETF RFC 3418/STD0062, Management Information Base (MIB) for the Simple Network Management Protocol (SNMP), December 2002.
- [RFC 3433] IETF RFC 3433, Entity Sensor Management Information Base, December 2002.
- [RFC 3484] IETF RFC 3484, Default Address Selection for Internet Protocol version 6 (IPv6), March 2003.
- [RFC 3569] IETF RFC 3569, An Overview of Source-Specific Multicast (SSM), July 2003.



- [RFC 3584] IETF RFC 3584, Coexistence between Version 1, Version 2, and Version 3 of the Internet-standard Network Management Framework, August 2003.
- [RFC 3635] IETF RFC 3635, Definitions of Managed Objects for the Ethernet-like Interface Types, October 2003.
- [RFC 3810] IETF RFC 3810, Multicast Listener Discovery Version 2 (MLDv2) for IPv6, June 2004.
- [RFC 4022] IETF RFC 4022, Management Information Base for the Transmission Control Protocol (TCP), March 2005.
- [RFC 4113] IETF RFC 4113, Management Information Base for the User Datagram Protocol (UDP), June 2005.
- [RFC 4133] IETF RFC 4133, Entity MIB (Version 3), August 2005.
- [RFC 4181] IETF RFC 4181, Guidelines for Authors and Reviewers of MIB Documents, September 2005.
- [RFC 4188] IETF RFC 4188, Definitions of Managed Objects for Bridges, September 2005.
- [RFC 4250] IETF RFC 4250, The Secure Shell (SSH) Protocol Assigned Numbers, January 2006.
- [RFC 4251] IETF RFC 4251, The Secure Shell (SSH) Protocol Architecture, January 2006.
- [RFC 4252] IETF RFC 4252, The Secure Shell (SSH) Authentication Protocol, January 2006.
- [RFC 4253] IETF RFC 4253, The Secure Shell (SSH) Transport Layer Protocol, January 2006.
- [RFC 4254] IETF RFC 4254, The Secure Shell (SSH) Connection Protocol, January 2006.
- [RFC 4293] IETF RFC 4293, Management Information Base for the Internet Protocol (IP), April 2006.
- [RFC 4323] IETF RFC 4323, Data Over Cable System Interface Specification Quality of Service Management Information Base (DOCSIS-QOS-MIB), January 2006.
- [RFC 4506] IETF RFC 4506/STD0067, XDR: External Data Representation Standard. M. Eisler, Ed. May 2006.
- [RFC 4546] IETF RFC 4546, Radio Frequency (RF) Interface Management Information Base for Data over Cable Service Interface Specifications (DOCSIS) 2.0 Compliant RF Interfaces, June 2006.
- [RFC 4601] IETF RFC 4601, Protocol Independent Multicast - Sparse Mode (PIM-SM): Protocol Specification (Revised), August 2006.
- [RFC 4639] IETF RFC 4639, Cable Device Management Information Base for Data-Over-Cable Service Interface Specification (DOCSIS) Compliant Cable Modems and Cable Modem Termination Systems, December 2006.
- [RFC 4742] IETF RFC 4742, Using the NETCONF Configuration Protocol over Secure Shell (SSH), December 2006.
- [RFC 5132] IETF RFC 5132, IP Multicast MIB, December 2007.
- [RFC 5246] IETF RFC 5246, The Transport Layer Security (TLS) Protocol Version 1.2, August 2008.
- [RFC 5277] IETF RFC 5277, NETCONF Event Notifications, July 2008.
- [RFC 5280] IETF RFC 5280, Internet X.509 Public Key Infrastructure Certificate and Certificate Revocation List (CRL) Profile, May 2008.
- [RFC 6241] IETF RFC 6241, NETCONF Configuration Protocol, June 2011.
- [RFC 6243] IETF RFC 6243, With-defaults Capability for NETCONF, June, 2011.
- [RFC 6991] IETF RFC 6991, Common YANG Data Types, July 2013.
- [RMI-SDR] DOCSIS Resource Management Interface, Service Discovery and Registration Specification, CM-SP-RMI-SDR-I02-150528, May 28, 2015, Cable Television Laboratories, Inc.

[SCTE 154-2]	ANSI SCTE 154-2 2008, SCTE-HMS-QAM-MIB.
[SCTE 154-4]	ANSI SCTE 154-4 2008, MPEG Management Information Base - SCTE-HMS-MPEG-MIB.
[SCTE 154-5]	ANSI SCTE 154-5 2008, SCTE-HMS-HEADENDIDENT TEXTUAL CONVENTIONS MIB.
[SECV3.1]	DOCSIS 3.1 Security Specification, CM-SP-SECV3.1-I07-170111, January 11, 2017, Cable Television Laboratories, Inc.
[W3 XML1.0]	Extensible Markup Language (XML) 1.0 (Third Edition), W3C Recommendation 04, February 2004.
[W3 XSD1.0]	XML Schema Part 1: Structures Second Edition, W3C Recommendation 28, October 2004.

## 2.2 Informative References

This specification uses the following informative references.

[CCAP TR]	Converged Cable Access Platform Architecture Technical Report, CM-TR-CCAP-V03-120511, May 11, 2012, Cable Television Laboratories, Inc.
[DRFI]	DOCSIS Downstream RF Interface Specification, CM-SP-DRFI-I16-170111, January 11, 2017, Cable Television Laboratories, Inc.
[DSG]	DOCSIS Set-top Gateway (DSG) Interface Specification, CM-SP-DSG-I24-130808, August 8, 2013, Cable Television Laboratories, Inc.
[ISO 11404]	BS ISO/IEC 11404:1996 Information technology--Programming languages, their environments and system software interfaces--Language-independent datatypes, January 2002.
[ISO 19501]	ISO/IEC 19501:2005, Information technology - Open Distributed Processing - Unified Modeling Language (UML) Version 1.4.2.
[ITU-T M.3400]	ITU-T Recommendation M.3400 (02/2000): TMN AND Network Maintenance: International Transmission Systems, Telephone Circuits, Telegraphy, Facsimile and Leased Circuits, TMN management functions.
[ITU-T X.692]	ITU-T Recommendation X.692 (03/2002), Information technology - ASN.1 encoding rules: Specification of Encoding Control Notation (ECN).
[NSI]	Cable Modem Termination System - Network Side Interface Specification, SP-CMTS-NSI-I01-960702, July 2, 1996, Cable Television Laboratories, Inc.
[PMI]	Edge QAM Provisioning and Management Interface Specification, CM-SP-EQAM-PMI-I02-111117, November 17, 2011, Cable Television Laboratories, Inc.
[PKT EM]	PacketCable Event Messages Specification, PKT-SP-EM-C01-071129, November 29, 2007, Cable Television Laboratories, Inc.
[RFC 791]	IETF RFC 791, Internet Protocol, September 1981.
[RFC 1042]	IETF RFC 1042/STD0043, Standard for the transmission of IP datagrams over IEEE 802 networks, February 1988.
[RFC 1123]	IETF RFC 1123/STD0003, Requirements for Internet Hosts - Application and Support, October 1989.
[RFC 1157]	IETF RFC 1157. Simple Network Management Protocol (SNMP), May 1990.
[RFC 1213]	IETF RFC 1213, Management Information Base for Network Management of TCP/IP-based internets:MIB-II, March 1991.
[RFC 1901]	IETF RFC 1901, Introduction to Community-based SNMPv2, January 1996.

- [RFC 2326] IETF RFC 2326, Real Time Streaming Protocol (RTSP), April 1998.
- [RFC 2579] IETF RFC 2579, Textual Conventions for SMIV2, April 1999.
- [RFC 2580] IETF RFC 2580, Conformance Statements for SMIV2, April 1999.
- [RFC 3168] IETF RFC 3168, The Addition of Explicit Congestion Notification (ECN) to IP, September 2001.
- [RFC 3260] IETF RFC 3260, New Terminology and Clarifications for Diffserv, April 2002.
- [RFC 3339] IETF RFC 3339, Date and Time on the Internet: Timestamps, July 2002.
- [RFC 3410] IETF RFC 3410, Introduction and Applicability Statements for Internet-Standard Management Framework, December 2002.
- [RFC 3411] IETF RFC 3411/STD0062, An Architecture for Describing Simple Network Management Protocol (SNMP) Management Frameworks, December 2002.
- [RFC 3413] IETF RFC 3413, Simple Network Management Protocol (SNMP) Applications, December 2002.
- [RFC 3414] IETF RFC 3414/STD0062, User-based Security Model (USM) for version 3 of the Simple Network Management Protocol (SNMPv3), December 2002.
- [RFC 3415] IETF RFC 3415, View-based Access Control Model (VACM) for the Simple Network Management Protocol (SNMP), December 2002.
- [RFC 3416] IETF RFC 3416, Version 2 of the Protocol Operations for the Simple Network Management Protocol (SNMP), December 2002.
- [RFC 3417] IETF RFC 3417, Transport Mappings for the Simple Network Management Protocol (SNMP), December 2002.
- [RFC 3419] IETF RFC 3419, Textual Conventions for Transport Addresses. M. Daniele, J. Schoenwaelder. December 2002.
- [RFC 3423] IETF RFC 3423, XACCT's Common Reliable Accounting for Network Element (CRANE), Protocol Specification Version 1.0, November 2002.
- [RFC 3826] IETF RFC 3826, The Advanced Encryption Standard (AES) Cipher Algorithm in the SNMP User-based Security Model, June 2004.
- [RFC 4001] IETF RFC 4001, Textual Conventions for Internet Network Addresses, February 2005.
- [RFC 4131] IETF RFC 4131, Management Information Base for Data Over Cable Service Interface Specification (DOCSIS) Cable Modems and Cable Modem Termination Systems for Baseline Privacy Plus, September 2005.
- [RFC 4291] IETF RFC 4291, IP Version 6 Addressing Architecture, February 2006.
- [RFC 4743] IETF RFC 4743, Using NETCONF over the Simple Object Access Protocol (SOAP), December 2006.
- [RFC 4744] IETF RFC 4744, Using the NETCONF Protocol over the Blocks Extensible Exchange Protocol (BEEP), December 2006.
- [RFC 5519] IETF RFC 5519, Multicast Group Membership Discovery MIB, April 2009.
- [RFC 5539] IETF RFC 5539, NETCONF over Transport Layer Security (TLS), May 2009.
- [RFC 6020] IETF RFC 6020, YANG - A data modeling language for the Network Configuration Protocol (NETCONF), October 2010.
- [RFC 6021] IETF RFC 6021, Common YANG Data Types, October 2010.

## 2.3 Reference Acquisition

- Cable Television Laboratories, Inc., 858 Coal Creek Circle, Louisville, CO 80027; Phone +1-303-661-9100; Fax +1-303-661-9199; <http://www.cablelabs.com>
- American National Standards Institute, Inc. 1819 L Street, NW, 6th floor Washington, DC 20036; Phone +1-202-293-8020; Fax +1-202-293-9287; <http://www.ansi.org>
- IANA, Internet Assigned Numbers Authority (IANA); <http://www.iana.org>
- IETF, Internet Engineering Task Force (IETF) Secretariat, 48377 Fremont Blvd., Suite 117, Fremont, California 94538, USA; Phone: +1-510-492-4080, Fax: +1-510-492-4001; <http://www.ietf.org/>
- IPDR Specifications, 240 Headquarters Plaza, East Tower, 10th Floor, Morristown, NJ 07960; Phone +1-973-944-5100; Fax +1-973-944-5110; <http://www.tmforum.org>
- ISO Specifications, International Organization for Standardization (ISO), 1, rue de Varembé, Case postale 56, CH-1211 Geneva 20, Switzerland; Phone +41 22 749 01 11; Fax +41 22 733 34 30; <http://www.iso.org>
- ITU Recommendations, International Telecommunication Union, Place des Nations, CH-1211, Geneva 20, Switzerland; Phone +41-22-730-51-11; Fax +41-22-733-7256; <http://www.itu.int>
- SCTE, Society of Cable Telecommunications Engineers Inc., 140 Philips Road, Exton, PA 19341; Phone: 610-363-6888 / 800-542-5040; Fax: 610-363-5898; <http://www.scte.org/>
- World Wide Web Consortium (W3C), Massachusetts Institute of Technology, 32 Vassar Street, Room 32-G515, Cambridge, MA 02139; Phone +1-617-253-2613, Fax +1-617-258-5999; <http://www.w3.org/Consortium/>

### 3 TERMS AND DEFINITIONS

This specification uses the following terms:

<b>Aggregation</b>	A special type of object association for Configuration Object Models in which objects are assembled or configured together to create a more complex object.
<b>Bridging CMTS</b>	A CMTS that makes traffic forwarding decisions between its Network Systems Interfaces and MAC Domain Interfaces based upon the Layer 2 Ethernet MAC address of a data frame.
<b>Cable Modem</b>	A modulator-demodulator at subscriber locations intended for use in conveying data communications on a cable television system.
<b>Cable Modem Termination System</b>	An access-side networking element or set of elements that includes one or more MAC Domains and one or more Network System Interfaces. This unit is located at the cable television system headend or distribution hub and provides data connectivity between a DOCSIS Radio Frequency Interface and a wide-area network.
<b>Cable Modem Termination System - Network Side Interface (CMTS-NSI)</b>	The interface, defined in [NSI], between a CMTS and the equipment on its network side.
<b>Carrier-to-Noise plus Interference Ratio (CNIR)</b>	The ratio of the expected commanded received signal power at the CMTS input to the noise plus interference in the channel.
<b>Channel</b>	The frequency spectrum occupied by a signal. Usually specified by center frequency and bandwidth parameters.
<b>Command Line Interface</b>	A mechanism used to interact with the CCAP by typing text-based commands into a system interface.
<b>Configuration Objects</b>	Managed objects in the CCAP configuration that support writeability. The CCAP is configured by specifying the attributes of these objects.
<b>Converged Cable Access Platform</b>	An access-side networking element or set of elements that combines the functionality of a CMTS with that of an Edge QAM, providing high-density services to cable subscribers.
<b>Customer Premises Equipment</b>	Equipment at the end user's premises; may be provided by the service provider.
<b>Datastore</b>	A collection of configuration objects used by the CCAP to define its configuration.
<b>Downstream</b>	Transmissions from CCAP to CM/CPE. Also, RF spectrum used to transmit signals from a cable operator's headend or hub site to subscriber locations.
<b>Edge QAM</b>	A headend or hub device that receives packets of digital video or data. It repacketizes the video or data into an MPEG transport stream and digitally modulates the digital transport stream onto a downstream RF carrier using quadrature amplitude modulation (QAM).
<b>Extensible Markup Language</b>	A universal file format for storing and exchanging structured data. The CCAP configuration file is created in XML and has a specific schema, generated from a set of YANG modules, which are a physical implementation of an object model created to describe CCAP configuration.
<b>FCAPS</b>	A set of principles for managing networks and systems, wherein each letter represents one principle. F is for Fault, C is for Configuration, A is for Accounting, P is for Performance, S is for Security.
<b>Flow</b>	A stream of packets used to transport data of a certain priority from the source to the sink.

<b>Generalization</b>	A relationship in which one configuration model element (the child) is based on another model element (the parent). A generalization relationship indicates that the child receives all of the attributes, operations, and relationships that are defined in the parent.
<b>Hybrid Fiber/Coax System</b>	A broadband bidirectional shared-media transmission system using optical fiber trunks between the headend and the fiber nodes, and coaxial cable distribution from the fiber nodes to the customer locations.
<b>Institute of Electrical and Electronic Engineers</b>	A voluntary organization which, among other things, sponsors standards committees and is accredited by the American National Standards Institute (ANSI).
<b>Internet Engineering Task Force</b>	A body responsible for, among other things, developing standards used in the Internet.
<b>Internet Protocol</b>	An Internet network-layer protocol.
<b>Internet Protocol Detail Records</b>	Provides information about Internet Protocol (IP)-based service usage and other activities that can be used by Operational Support Systems (OSS) and Business Support Systems (BSS).
<b>IPDRDoc</b>	Master IPDR Schema Document [IPDR/BSR]
<b>MAC Domain</b>	A grouping of Layer 2 devices that can communicate with each other without using bridging or routing. In DOCSIS, it is the group of CMs that are using upstream and downstream channels linked together through a MAC forwarding entity.
<b>MAC Domain Cable Modem Service Group</b>	The subset of a Cable Modem Service Group which is confined to the Downstream Channels and Upstream Channels of a single MAC domain. Differs from a CM-SG only if multiple MAC domains are assigned to the same CM-SGs.
<b>Management</b>	Functions on the CCAP that monitor for faults and for overall system performance, including traps and alarms.
<b>Media Access Control</b>	Used to refer to the Layer 2 element of the system which would include DOCSIS framing and signaling.
<b>Management Information Base</b>	A database of device configuration and performance information which is acted upon by SNMP.
<b>Multimedia Terminal Adapter</b>	A combination cable modem and telephone adapter.
<b>Multiple System Operator</b>	A corporate entity that owns and/or operates more than one cable system.
<b>Network Configuration Protocol</b>	An IETF network management protocol that provides mechanisms to manipulate the configuration of a device, commonly referred to as NETCONF. NETCONF executes YANG-based XML files containing configuration objects.
<b>Open Systems Interconnection (OSI)</b>	A framework of ISO standards for communication between different systems made by different vendors, in which the communications process is organized into seven different categories that are placed in a layered sequence based on their relationship to the user. Each layer uses the layer immediately below it and provides a service to the layer above. Layers 7 through 4 deal with end-to-end communication between the message source and destination, and layers 3 through 1 deal with network functions.
<b>Physical (PHY) Layer</b>	Layer 1 in the Open System Interconnection (OSI) architecture; the layer that provides services to transmit bits or groups of bits over a transmission link between open systems and which entails electrical, mechanical and handshaking procedures.

<b>pyang</b>	A YANG validator, transformer, and code generator, written in Python, that is used to generate the CCAP schema file from the CCAP YANG modules.
<b>Quadrature Amplitude Modulation</b>	A modulation technique in which an analog signal's amplitude and phase vary to convey information, such as digital data.
<b>QAM Channel</b>	Analog RF channel that uses quadrature amplitude modulation (QAM) to convey information.
<b>Radio Frequency</b>	In cable television systems, this refers to electromagnetic signals in the range 5 to 1000 MHz.
<b>Remote Authentication Dial In User Service</b>	Networking protocol that provides centralized authentication, authorization, and accounting (AAA) management for computers to connect and use a network service.
<b>Request for Comments</b>	A technical policy document of the IETF; these documents can be accessed at <a href="http://www.rfc-editor.org/">http://www.rfc-editor.org/</a> .
<b>Routing CMTS</b>	A CMTS that makes traffic forwarding decisions between its Network System Interfaces and MAC Domain Interfaces based upon the Layer 3 (network) address of a packet.
<b>Running-config</b>	Configuration objects that control CCAP behavior, along with any vendor-proprietary configurations.
<b>Secure Copy Protocol</b>	A secure file transfer protocol based on Secure Shell (SSH).
<b>Simple Network Management Protocol</b>	Allows a host to query modules for network-related statistics and error conditions.
<b>Specialization</b>	A relationship in which one configuration model element (the parent) is used to model another element (the child). The specialized child element receives all of the attributes, operations, and relationships that are defined in the parent and defines additional attributes, operations and relationships that enable its specialized behavior.
<b>Startup-config</b>	The configuration objects stored in non-volatile memory.
<b>Terminal Access Controller Access-Control System Plus</b>	Protocol that provides access control for routers, network access servers and other networked computing devices via one or more centralized servers.
<b>Upstream</b>	Transmissions from CM to CCAP. Also, RF spectrum used to transmit signals from a subscriber location to a cable operator's headend or hub site.
<b>Video-on-Demand System</b>	System that enables individuals to select and watch video.
<b>X.509</b>	ITU-T Recommendation standard for a public key infrastructure (PKI) for single sign-on (SSO) and Privilege Management Infrastructure (PMI).
<b>YANG</b>	A data modeling language for the NETCONF network configuration protocol. Though the CCAP physical data model for configuration makes use of one or more YANG modules, NETCONF implementation is not required for the integrated CCAP.

## 4 ABBREVIATIONS, ACRONYMS, AND NAMESPACES

This specification uses the following abbreviations:

<b>AAA</b>	Network Authentication, Authorization, and Accounting
<b>AAA</b>	Authentication, Authorization, and Accounting
<b>ACK</b>	Acknowledge
<b>ACL</b>	Access Control List
<b>ANSI</b>	American National Standards Institute
<b>AQM</b>	Active Queue Management
<b>ASCII</b>	American Standard Code for Information Interchange
<b>ASF</b>	Aggregated Service Flow
<b>ASM</b>	Any Source Multicast
<b>ATDMA</b>	Advanced Time Division Multiple Access
<b>BPI</b>	Baseline Privacy Interface
<b>BPKM</b>	Baseline Privacy Key Management
<b>BSR</b>	Business Solution Requirements
<b>BSS</b>	Business Support Systems
<b>C</b>	Celsius (temperature)
<b>CA</b>	Certificate Authority
<b>CAS</b>	Conditional Access System
<b>CAT</b>	Conditional Access Table
<b>CATV</b>	Cable Television
<b>CCAP</b>	Converged Cable Access Platform
<b>CCI</b>	Copy Control Information
<b>CLI</b>	Command Line Interface
<b>CM</b>	Cable Modem
<b>CMTS</b>	Cable Modem Termination System
<b>CoS</b>	Class of Service
<b>CP</b>	Cyclic Prefix
<b>CPAF</b>	Configuration, Performance, Accounting, Fault Management
<b>CPE</b>	Customer Premises Equipment
<b>CRANE</b>	Common Reliable Accounting for Network Elements
<b>CRL</b>	Certificate Revocation List
<b>CW</b>	Control Word
<b>dB</b>	decibel
<b>DBC</b>	Dynamic Bonding Change
<b>DBG</b>	Downstream Bonding Group
<b>DC</b>	Downstream Channel
<b>DCC</b>	Dynamic Channel Change
<b>DCID</b>	Downstream Channel Identifier
<b>DCS</b>	Downstream Channel Sets



<b>DES</b>	Digital Encryption Standard
<b>DHCP</b>	Dynamic Host Configuration Protocol
<b>DLC</b>	Downstream Line Card
<b>DLS</b>	DOCSIS Light Sleep [mode]
<b>DPD</b>	Downstream Profile Descriptor
<b>DPoE</b>	DOCSIS Provisioning of EPON
<b>DS</b>	Downstream
<b>DSAP</b>	Destination Service Access Point
<b>DSCP</b>	Differentiated Services (Diffserv) Code Point
<b>DSG</b>	DOCSIS Set-top Gateway
<b>DSID</b>	Downstream Service ID
<b>DST</b>	Daylight Saving Time
<b>DTD</b>	Document Type Definition
<b>DTI</b>	DOCSIS Timing Interface
<b>EAE</b>	Early Authentication and Encryption
<b>ECM</b>	Entitlement Control Message
<b>ECMD</b>	ECM Decoder
<b>ECMG</b>	ECM Generator
<b>EM</b>	Event Message OR Energy Management
<b>EM-ID</b>	Energy Management Identifier
<b>EMM</b>	Entitlement Management Message
<b>EPON</b>	Ethernet Passive Optical Network
<b>EQAM</b>	Edge QAM
<b>ERM</b>	Edge Resource Manager
<b>ERMI</b>	Edge Resource Manager Interface
<b>ERRP</b>	Edge Resource Registration Protocol
<b>ETV</b>	Enhanced Television
<b>ETVBIF</b>	Enhanced Television Binary Interchange Format
<b>FCAPS</b>	Fault, Configuration, Accounting, Performance and Security
<b>FEC</b>	Forward Error Connection
<b>FFT</b>	Fast Fourier Transform
<b>FQDN</b>	Fully Qualified Domain Name
<b>FRU</b>	Field Replaceable Unit
<b>FSM</b>	Finite State Machine
<b>FTP</b>	File Transfer Protocol
<b>GC</b>	Group Configuration
<b>GCR</b>	Group Classifier Rule
<b>GLBG</b>	General Load Balancing Group
<b>GMT</b>	Greenwich Mean Time
<b>GQC</b>	Group QoS Configuration
<b>GSF</b>	Group Service Flow

<b>HCS</b>	Header Check Sequence
<b>HFC</b>	Hybrid Fiber/Coax System
<b>HMAC</b>	Keyed-Hash Message Authentication Code
<b>HQoS</b>	Hierarchical Quality of Service
<b>HTTP</b>	Hypertext Transfer Protocol
<b>HTTPS</b>	Secure Hypertext Transfer Protocol
<b>IATC</b>	Interface Aggregate Traffic Class
<b>ID</b>	Identifier
<b>IDL</b>	Interactive Data Language
<b>IEC</b>	International Electrotechnical Commission
<b>IEEE</b>	Institute of Electrical and Electronic Engineers
<b>IETF</b>	Internet Engineering Task Force
<b>IFFT</b>	Inverse Fast Fourier Transform
<b>IGMP</b>	Internet Group Management Protocol
<b>INIT</b>	Initialize or Initialization
<b>IP</b>	Internet Protocol
<b>IPDR</b>	Internet Protocol Detail Record
<b>IPv4</b>	Internet Protocol version 4
<b>IPv6</b>	Internet Protocol version 6
<b>IR</b>	Internet Protocol Detail Record Recorder
<b>IS</b>	Internet Protocol Detail Record Store
<b>ISO</b>	International Organization for Standardization
<b>IT</b>	Internet Protocol Detail Record Transmitter
<b>ITU</b>	International Telecommunication Union
<b>IUC</b>	Interval Usage Code (has iterations of 1,2, and 3)
<b>J2EE</b>	Java 2 Platform, Enterprise Edition
<b>kHz</b>	kilohertz
<b>L2VPN</b>	Layer 2 Virtual Private Network
<b>LAN</b>	Local Area Network
<b>log</b>	logarithm
<b>LSB</b>	Least Significant Bit
<b>LTE</b>	Long Term Evolution
<b>MAC</b>	Media Access Control
<b>MAP</b>	Bandwidth Allocation Map
<b>M-CMTS</b>	Modular Cable Modem Termination System
<b>MD-CM-SG</b>	Media Access Control Domain Cable Modem Service Group
<b>MDD</b>	MAC Domain Descriptor
<b>MD-DS-SG</b>	Media Access Control Domain Downstream Service Group
<b>MDF</b>	Multicast DSID Forwarding
<b>MD-US-SG</b>	Media Access Control Domain Upstream Service Group
<b>MER</b>	Modulation Error Ratio

<b>MGMD</b>	Multicast Group Membership Discovery
<b>MHz</b>	megahertz
<b>MIB</b>	Management Information Base
<b>MIC</b>	Message Integrity Check
<b>MLD</b>	Multicast Listener Discovery
<b>MPD</b>	Message Processing and Dispatching
<b>MPTS</b>	Multi-Program Transport Stream
<b>MSB</b>	Most Significant Bit
<b>MSO</b>	Multiple System Operator
<b>MTA</b>	Multimedia Terminal Adapter
<b>MTC</b>	Multiple Transmit Channel
<b>MULPI</b>	MAC and Upper Layer Protocols Interface
<b>NETCONF</b>	Network Configuration Protocol
<b>NMS</b>	Network Management System
<b>NOC</b>	Network Operations Center
<b>NSI</b>	Network Side Interface
<b>OCD</b>	OFDM Channel Descriptor
<b>OCSP</b>	Online Certification Status Protocol
<b>OFDM</b>	Orthogonal Frequency Division Multiplexing
<b>OFDMA</b>	Orthogonal Frequency Division Multiplexing with Multiple Access
<b>OM</b>	Object Model (Information Model)
<b>OMG</b>	Object Management Group
<b>ONU</b>	Optical Network Unit
<b>OSS</b>	Operations Support System
<b>OSSI</b>	Operations Support System Interface
<b>OUI</b>	Organization Unique Identifier
<b>PAT</b>	Program Association Table
<b>PCMM</b>	PacketCable Multimedia
<b>PE</b>	Physical and Environmental
<b>PEN</b>	Private Enterprise Number
<b>PHY</b>	Physical Layer
<b>PID</b>	Packet Identifier
<b>P-IE</b>	Probe Information Element
<b>PMT</b>	Program Map Table
<b>PNM</b>	Proactive Network Maintenance
<b>PON</b>	Passive Optical Network
<b>PS</b>	CableHome Portal Services
<b>PSD</b>	Power Spectral Density
<b>QAM</b>	Quadrature Amplitude Modulation
<b>QoS</b>	Quality of Service
<b>QPSK</b>	Quadrature Phase Shift Keying

<b>RADIUS</b>	Remote Authentication Dial In User Service
<b>RCC</b>	Receive Channel Configuration
<b>RCP</b>	Receive Channel Profile
<b>RCP-ID</b>	RCP-Identifier
<b>RCS</b>	Receive Channel Set
<b>RCT</b>	Redistribution Control Trigger
<b>REG</b>	Registration
<b>RF</b>	Radio Frequency
<b>RFC</b>	Request for Comments
<b>RFI</b>	Radio Frequency Interface
<b>RKS</b>	Record Keeping Server
<b>RPC</b>	Remote Procedure Call
<b>RTSP</b>	Real Time Streaming Protocol
<b>RxMER</b>	Receive (channel) Modulation Error Ratio
<b>SA</b>	Security Association
<b>SAID</b>	Security Association Identifier
<b>SAMIS</b>	Subscriber Accounting Management Interface Specification
<b>SAV</b>	Source Address Verification
<b>SC</b>	Service Consumer
<b>S-CDMA</b>	Synchronous Code Division Multiple Access
<b>SCN</b>	Service Class Name
<b>SCP</b>	Secure Copy Protocol
<b>SC-QAM</b>	Single-Carrier QAM
<b>SDV</b>	Switched Digital Video
<b>SE</b>	Service Element
<b>SEC</b>	Security
<b>SF</b>	Service Flow
<b>SFID</b>	Service Flow ID
<b>SID</b>	Service Identifier
<b>SLA</b>	Service Level Agreement
<b>SMIv1</b>	Structure of Management Information version 1
<b>SMIv2</b>	Structure of Management Information version 2
<b>SNAP</b>	Sub-Network Access Protocol
<b>SNMP</b>	Simple Network Management Protocol
<b>SNMPv1</b>	Version 1 of the Simple Network Management Protocol
<b>SNMPv2</b>	Version 2 of Simple Network Management Protocol
<b>SNMPv2c</b>	Community-Based Simple Network Management Protocol, version 2
<b>SNMPv3</b>	Version 3 of the Simple Network Management Protocol
<b>SP</b>	Streaming Protocol
<b>SRE</b>	System Route Engine
<b>SSH</b>	Secure Shell

<b>SSM</b>	Source Specific Multicast
<b>STP</b>	Spanning Tree Protocol
<b>SW</b>	Software
<b>SYNC</b>	Synchronize or Synchronization
<b>TACACS+</b>	Terminal Access Controller Access-Control System Plus
<b>TCP</b>	Transmission Control Protocol
<b>TCS</b>	Transmit Channel Set
<b>TDMA</b>	Time Division Multiple Access
<b>TEK</b>	Traffic Encryption Key
<b>TFTP</b>	Trivial File Transfer Protocol
<b>TLS</b>	Transport Layer Security
<b>TLV</b>	Type Length Value Attribute
<b>ToD</b>	Time of Day
<b>ToS</b>	Terms of Service
<b>TS</b>	Transport Stream
<b>TSID</b>	Transport Stream Identifier
<b>UBG</b>	Upstream Bonding Group
<b>UC</b>	Upstream Channel
<b>UCC</b>	Upstream Channel Change
<b>UCID</b>	Upstream Channel Identifier
<b>UDC</b>	Upstream Drop Classifier
<b>UDP</b>	User Datagram Protocol
<b>ULC</b>	Upstream Line Card
<b>UML</b>	Unified Modeling Language
<b>URL</b>	Uniform Resource Locator
<b>US</b>	Upstream
<b>UTC</b>	Coordinated Universal Time
<b>VACM</b>	View-based Access Control Model
<b>VIVSO</b>	Vendor-Identifying Vendor-Specific Options
<b>VLAN</b>	Virtual Local Area Network
<b>VOD</b>	Video-On-Demand
<b>WAN</b>	Wide Area Network
<b>XDR</b>	External Data Representation
<b>XML</b>	Extensible Markup Language
<b>XSD</b>	XML Schema Definition

## 4.1 XML Namespaces<sup>4</sup>

This specification uses the following XML namespace prefixes to indicate the corresponding public XML namespaces.

**Table 4-1 - Public XML Namespaces**

Prefix	XML Namespace	Specification Reference
xsd	http://www.w3.org/2001/XMLSchema	[W3 XSD1.0]
xsi	http://www.w3.org/2001/XMLSchema-instance	[W3 XSD1.0]
ipdr	http://www.ipdr.org/namespaces/ipdr	[IPDR/SSDG]

This specification defines the following XML namespaces for DOCSIS IPDR Service Definitions.

**Table 4-2 - IPDR Service Definition Namespaces**

Prefix	XML Namespace
DOCSIS-SAMIS-TYPE-1	http://www.cablelabs.com/namespaces/DOCSIS/3.0/xsd/ipdr/DOCSIS-SAMIS-TYPE-1
DOCSIS-SAMIS-TYPE-2	http://www.cablelabs.com/namespaces/DOCSIS/3.0/xsd/ipdr/DOCSIS-SAMIS-TYPE-2
DOCSIS-CMTS-CM-US-STATS-TYPE	http://www.cablelabs.com/namespaces/DOCSIS/3.0/xsd/ipdr/DOCSIS-CMTS-CM-US-STATS-TYPE
DOCSIS-CMTS-CM-REG-STATUS-TYPE	http://www.cablelabs.com/namespaces/DOCSIS/3.1/xsd/ipdr/DOCSIS-CMTS-CM-REG-STATUS-TYPE
DOCSIS-CMTS-TOPOLOGY-TYPE	http://www.cablelabs.com/namespaces/DOCSIS/3.0/xsd/ipdr/DOCSIS-CMTS-TOPOLOGY-TYPE
DOCSIS-SPECTRUM-MEASUREMENT-TYPE	http://www.cablelabs.com/namespaces/DOCSIS/3.0/xsd/ipdr/DOCSIS-SPECTRUM-MEASUREMENT-TYPE
DOCSIS-CPE-TYPE	http://www.cablelabs.com/namespaces/DOCSIS/3.0/xsd/ipdr/DOCSIS-CPE-TYPE
DOCSIS-DIAG-LOG-TYPE	http://www.cablelabs.com/namespaces/DOCSIS/3.0/xsd/ipdr/DOCSIS-DIAG-LOG-TYPE
DOCSIS-DIAG-LOG-EVENT-TYPE	http://www.cablelabs.com/namespaces/DOCSIS/3.0/xsd/ipdr/DOCSIS-DIAG-LOG-EVENT-TYPE
DOCSIS-DIAG-LOG-DETAIL-TYPE	http://www.cablelabs.com/namespaces/DOCSIS/3.0/xsd/ipdr/DOCSIS-DIAG-LOG-DETAIL-TYPE
DOCSIS-CMTS-US-UTIL-STATS-TYPE	http://www.cablelabs.com/namespaces/DOCSIS/3.0/xsd/ipdr/DOCSIS-CMTS-US-UTIL-STATS-TYPE
DOCSIS-CMTS-DS-UTIL-STATS-TYPE	http://www.cablelabs.com/namespaces/DOCSIS/3.0/xsd/ipdr/DOCSIS-CMTS-DS-UTIL-STATS-TYPE
DOCSIS-CMTS-CM-SERVICE-FLOW-TYPE	http://www.cablelabs.com/namespaces/DOCSIS/3.1/xsd/ipdr/DOCSIS-CMTS-CM-SERVICE-FLOW-TYPE
DOCSIS-IP-MULTICAST-STATS-TYPE	http://www.cablelabs.com/namespaces/DOCSIS/3.0/xsd/ipdr/DOCSIS-IP-MULTICAST-STATS-TYPE
DOCSIS-CMTS-CM-DS-OFDM-PROFILE-STATUS-TYPE	http://www.cablelabs.com/namespaces/DOCSIS/3.1/xsd/ipdr/DOCSIS-CMTS-CM-DS-OFDM-PROFILE-STATUS-TYPE
DOCSIS-CMTS-CM-DS-OFDM-STATUS-TYPE	http://www.cablelabs.com/namespaces/DOCSIS/3.1/xsd/ipdr/DOCSIS-CMTS-CM-DS-OFDM-PROFILE-TYPE
CMTS-CM-US-OFDMA-PROFILE-STATUS-TYPE	http://www.cablelabs.com/namespaces/DOCSIS/3.1/xsd/ipdr/DOCSIS-CMTS-CM-US-OFDMA-PROFILE-STATUS-TYPE
CMTS-CM-US-OFDMA-STATUS-TYPE	http://www.cablelabs.com/namespaces/DOCSIS/3.1/xsd/ipdr/DOCSIS-CMTS-CM-US-OFDMA-STATUS-TYPE
DS-OFDM-PROFILE-STATS-TYPE	http://www.cablelabs.com/namespaces/DOCSIS/3.1/xsd/ipdr/DOCSIS-DS-OFDM-PROFILE-STATS-TYPE
US-OFDMA-PROFILE-STATS-TYPE	http://www.cablelabs.com/namespaces/DOCSIS/3.1/xsd/ipdr/DOCSIS-US-OFDMA-PROFILE-STATS-TYPE"

<sup>4</sup> Modified per CCAP-OSSv3.1-N-15.1390-2 on 11/11/15 by KB.

This specification defines the following XML namespaces for DOCSIS auxiliary schemas.

**Table 4-3 - Auxiliary Schema Namespaces**

<b>Prefix</b>	<b>XML Namespace</b>
DOCSIS-CMTS	<a href="http://www.cablelabs.com/namespaces/DOCSIS/3.0/xsd/ipdr/DOCSIS-CMTS">http://www.cablelabs.com/namespaces/DOCSIS/3.0/xsd/ipdr/DOCSIS-CMTS</a>
DOCSIS-CM	<a href="http://www.cablelabs.com/namespaces/DOCSIS/3.0/xsd/ipdr/DOCSIS-CM">http://www.cablelabs.com/namespaces/DOCSIS/3.0/xsd/ipdr/DOCSIS-CM</a>
DOCSIS-CPE	<a href="http://www.cablelabs.com/namespaces/DOCSIS/3.0/xsd/ipdr/DOCSIS-CPE">http://www.cablelabs.com/namespaces/DOCSIS/3.0/xsd/ipdr/DOCSIS-CPE</a>
DOCSIS-QOS	<a href="http://www.cablelabs.com/namespaces/DOCSIS/3.0/xsd/ipdr/DOCSIS-QOS">http://www.cablelabs.com/namespaces/DOCSIS/3.0/xsd/ipdr/DOCSIS-QOS</a>
DOCSIS-REC	<a href="http://www.cablelabs.com/namespaces/DOCSIS/3.0/xsd/ipdr/DOCSIS-REC">http://www.cablelabs.com/namespaces/DOCSIS/3.0/xsd/ipdr/DOCSIS-REC</a>
DOCSIS-CMTS-CM-US	<a href="http://www.cablelabs.com/namespaces/DOCSIS/3.0/xsd/ipdr/DOCSIS-CMTS-CM-US">http://www.cablelabs.com/namespaces/DOCSIS/3.0/xsd/ipdr/DOCSIS-CMTS-CM-US</a>
DOCSIS-CMTS-CM-NODE-CH	<a href="http://www.cablelabs.com/namespaces/DOCSIS/3.0/xsd/ipdr/DOCSIS-CMTS-CM-NODE-CH">http://www.cablelabs.com/namespaces/DOCSIS/3.0/xsd/ipdr/DOCSIS-CMTS-CM-NODE-CH</a>
DOCSIS-MD-NODE	<a href="http://www.cablelabs.com/namespaces/DOCSIS/3.0/xsd/ipdr/DOCSIS-MD-NODE">http://www.cablelabs.com/namespaces/DOCSIS/3.0/xsd/ipdr/DOCSIS-MD-NODE</a>
DOCSIS-SPECTRUM	<a href="http://www.cablelabs.com/namespaces/DOCSIS/3.0/xsd/ipdr/DOCSIS-SPECTRUM">http://www.cablelabs.com/namespaces/DOCSIS/3.0/xsd/ipdr/DOCSIS-SPECTRUM</a>
DOCSIS-DIAG-LOG	<a href="http://www.cablelabs.com/namespaces/DOCSIS/3.0/xsd/ipdr/DOCSIS-DIAG-LOG">http://www.cablelabs.com/namespaces/DOCSIS/3.0/xsd/ipdr/DOCSIS-DIAG-LOG</a>
DOCSIS-DIAG-LOG-DETAIL	<a href="http://www.cablelabs.com/namespaces/DOCSIS/3.0/xsd/ipdr/DOCSIS-DIAG-LOG-DETAIL">http://www.cablelabs.com/namespaces/DOCSIS/3.0/xsd/ipdr/DOCSIS-DIAG-LOG-DETAIL</a>
DOCSIS-CMTS-US-UTIL	<a href="http://www.cablelabs.com/namespaces/DOCSIS/3.0/xsd/ipdr/DOCSIS-CMTS-US-UTIL">http://www.cablelabs.com/namespaces/DOCSIS/3.0/xsd/ipdr/DOCSIS-CMTS-US-UTIL</a>
DOCSIS-CMTS-DS-UTIL	<a href="http://www.cablelabs.com/namespaces/DOCSIS/3.0/xsd/ipdr/DOCSIS-CMTS-DS-UTIL">http://www.cablelabs.com/namespaces/DOCSIS/3.0/xsd/ipdr/DOCSIS-CMTS-DS-UTIL</a>
DOCSIS-SERVICE-FLOW	<a href="http://www.cablelabs.com/namespaces/DOCSIS/3.1/xsd/ipdr/DOCSIS-SERVICE-FLOW">http://www.cablelabs.com/namespaces/DOCSIS/3.1/xsd/ipdr/DOCSIS-SERVICE-FLOW</a>
DOCSIS-IP-MULTICAST	<a href="http://www.cablelabs.com/namespaces/DOCSIS/3.0/xsd/ipdr/DOCSIS-IP-MULTICAST">http://www.cablelabs.com/namespaces/DOCSIS/3.0/xsd/ipdr/DOCSIS-IP-MULTICAST</a>
DOCSIS-CMTS-CM-DS-OFDM	<a href="http://www.cablelabs.com/namespaces/DOCSIS/3.1/xsd/ipdr/DOCSIS-CMTS-CM-DS-OFDM">http://www.cablelabs.com/namespaces/DOCSIS/3.1/xsd/ipdr/DOCSIS-CMTS-CM-DS-OFDM</a>
DOCSIS-CMTS-CM-PARTIAL	<a href="http://www.cablelabs.com/namespaces/DOCSIS/3.1/xsd/ipdr/DOCSIS-CMTS-CM-PARTIAL">http://www.cablelabs.com/namespaces/DOCSIS/3.1/xsd/ipdr/DOCSIS-CMTS-CM-PARTIAL</a>
DOCSIS-CMTS-CM-US-OFDMA	<a href="http://www.cablelabs.com/namespaces/DOCSIS/3.1/xsd/ipdr/DOCSIS-CMTS-CM-US-OFDMA">http://www.cablelabs.com/namespaces/DOCSIS/3.1/xsd/ipdr/DOCSIS-CMTS-CM-US-OFDMA</a>
DOCSIS-OFDM-PROFILE	<a href="http://www.cablelabs.com/namespaces/DOCSIS/3.1/xsd/ipdr/DOCSIS-OFDM-PROFILE">http://www.cablelabs.com/namespaces/DOCSIS/3.1/xsd/ipdr/DOCSIS-OFDM-PROFILE</a>

## 5 OVERVIEW

### 5.1 FCAPS Network Management Model

The International Telecommunication Union (ITU) Recommendation [ITU-T M.3400] defines a set of management categories, referred to as the FCAPS model, represented by the individual management categories of Fault, Configuration, Accounting, Performance and Security. Telecommunications operators, including MSOs, commonly use this model to manage large networks of devices. This specification uses these management categories to organize the requirements for the configuration and management of the CCAP platform.

Fault management seeks to identify, isolate, correct and record system faults. Configuration management modifies system configuration variables and collects configuration information. Accounting management collects usage statistics for subscribers, sets usage quotas and bills users according to their use of the system. Performance management focuses on the collection of performance metrics, analysis of these metrics and the setting of thresholds and rate limits. Security management encompasses identification and authorization of users and equipment, provides audit logs and alerting functions, as well as providing vulnerability assessment.

Each of these management categories is discussed in further detail in the following sections.

#### 5.1.1 Fault Management

Fault management is a proactive and on-demand network management function that allows non-standard/abnormal operation on the network to be detected, diagnosed, and corrected. A typical use case involves network elements detecting service-impacting abnormalities; when detected, an autonomous event (often referred to as an alarm notification) is sent to the network operations center (NOC) to alert the MSO of a possible fault condition in the network affecting a customer's service. Once the MSO receives the event notification, further troubleshooting and diagnostics can be performed by the MSO to correct the fault condition and restore the service to proper operation. Example Fault Management use cases are shown in the following diagram.



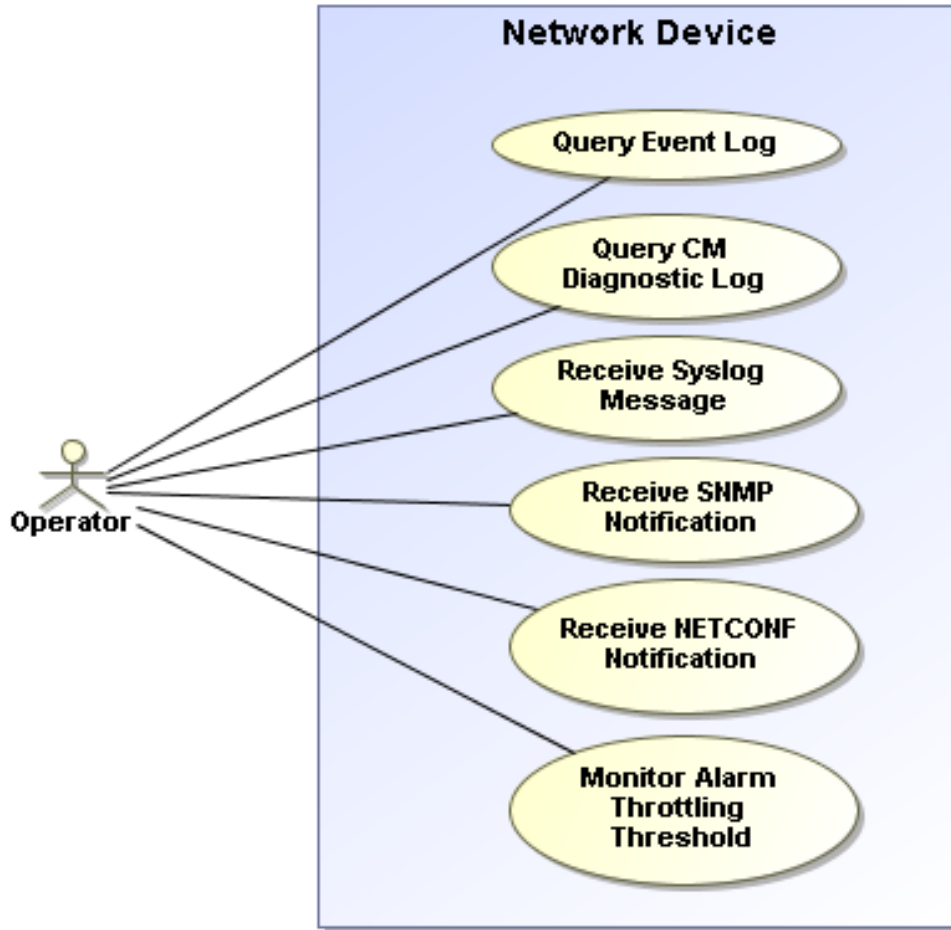

Figure 5-1 - Fault Management Use Cases

### 5.1.2 Configuration Management

Configuration Management provides a set of network management functions that enables system configuration building and instantiating, installation and system turn up, network and device provisioning, auto-discovery, backup and restore, software download, status, and control (e.g., checking or changing the service state of an interface). Example Configuration Management use cases are shown in the following diagram.



**Figure 5-2 - Configuration Management Use Cases**

Configuration Management is primarily concerned with network control via modifying operating parameters on network elements such as the CCAP. Configuration parameters could include both physical resources (for example, an Ethernet interface) and logical objects (for example, QoS parameters for a given service flow).

While the network is in operation, Configuration Management is responsible for monitoring the configuration state and making changes in response to commands by a management system or some other network management function.

For example, a performance management function may detect that response time is degrading due to a high number of uncorrected frames, and may issue a Configuration Management change to modify the modulation type from 16-QAM to QPSK. A Fault Management function may detect and isolate a fault and may issue a configuration change to mitigate or correct that fault.

### 5.1.3 Accounting Management

Accounting Management is a network management function that allows MSOs to measure the use of network services by subscribers for the purposes of cost estimation and subscriber billing. The CCAP is the network element that is responsible for providing the usage statistics to support billing. Subscriber Accounting Management Interface Specification (SAMIS) is an example of an implemented Accounting Management function. Billing is outside the scope of this specification.

### 5.1.4 Performance Management

Performance Management is a proactive and on-demand network management function. The ITU Recommendation [ITU-T M.3400] defines its role as gathering and analyzing "statistical data for the purpose of monitoring and correcting the behavior and effectiveness of the network, network equipment, or other equipment and to aid in planning, provisioning, maintenance and the measurement of quality." A Performance Management use case might include the NOC performing periodic (15 min, for example) collections of QoS measurements from network elements to perform monitoring and identification of any potential performance issues that may be occurring with the service being monitored. With the historical data that has been collected, trending analysis can be performed to identify issues that may be related to certain times of day or other corollary events. The MSO can run reports on the data to identify suspect problems in service quality, or the NOC application can be provisioned, so that when certain performance thresholds are violated, the MSO is automatically notified that a potential service quality problem may be pending. Significant intelligence can be integrated into the NOC application to automate the ability to detect the possible degradation of a customer's service quality, and take actions to correct the condition. Service level agreement compliance is not possible without strong performance management.

Performance Management functions include collecting statistics of parameters such as number of frames lost at the MAC layer and number of codeword errors at the PHY layer. These monitoring functions are used to determine the health of the network and whether the offered Quality of Service (QoS) to the subscriber is met. The quality of signal at the PHY layer is an indication of plant conditions.

### 5.1.5 Security Management

Security Management provides for the management of network and operator security, as well as providing an umbrella of security for the telecommunications management network functions. Security Management functions include authentication, access control, data confidentiality, data integrity, event detection, and reporting. A Security Management use case might include providing authentication and data confidentiality when transferring a configuration file that contains the entire configuration data set for the device to a network element. These functions are covered in context within this specification.

## 5.2 Management Architectural Overview

Figure 5-3 illustrates the CCAP management architecture from the MSO back office interface perspective. The CM and CCAP reside within the Network Layer where services are provided to end Subscribers and various metrics are collected about network and service performance, among other things. Various management servers reside in the Network Management Layer within the MSO back office to provision, monitor and administer the Network Elements within the Network Layer (CM in this case). These management servers include, but are not limited to:

- SNMP Manager - performs SNMP queries against a CCAP's SNMP Agent.
- Configuration File Server - has the responsibility of transferring XML configuration files to the CCAP.
- Notification Receiver - receives autonomous SNMP and optional NETCONF notifications and Syslog messages from a CCAP.

- DHCP Server - has the responsibility of assigning a CCAP its IPv4 and/or IPv6 addresses as well as other DHCP parameters.
- Time Server - provides a CCAP with current Time of Day (ToD).
- IPDR Collectors - primary and secondary - collect bulk data statistics, such as usage metrics, via the IPDR/SP protocol.
- Certificate Revocation Server - provides information and status for security certificates.

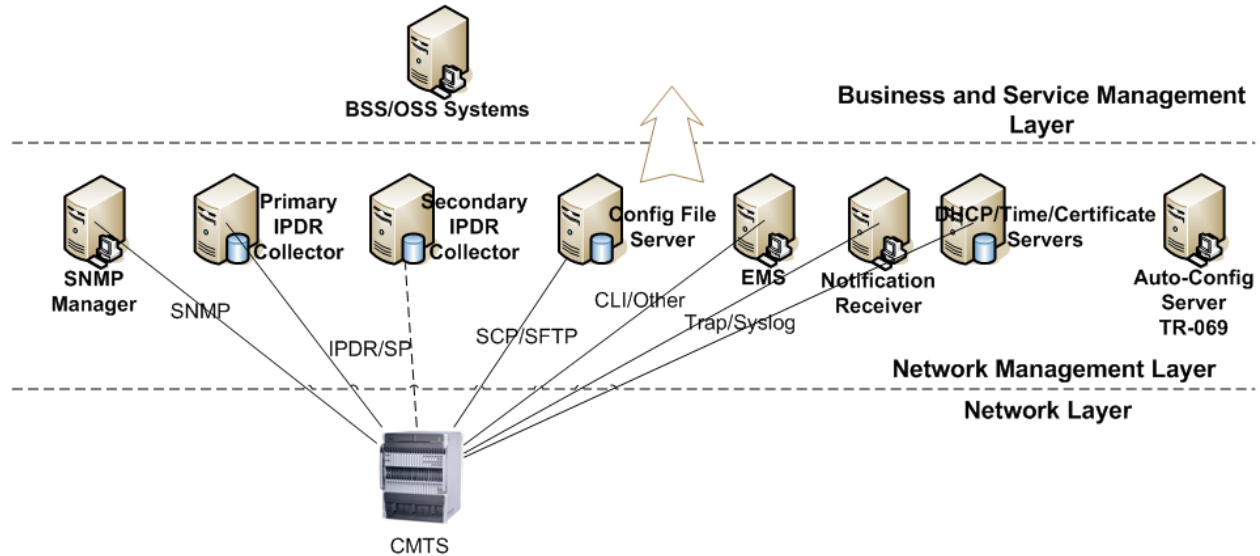

Figure 5-3 - CMTS and CCAP Management Architecture

Finally, the Business and Service Management Layer is where higher level MSO business processes are implemented via BSS/OSS systems. These BSS/OSS systems utilize the data and information from the Network Management Layer which interrogate data from the Network Layer.

### 5.3 DOCSIS 3.1 OSSI Key Features

DOCSIS 3.1 introduces a number of features that build upon features introduced in previous versions of DOCSIS. This specification includes the key new features for the Operations Support System Interface (OSSI) based on the requirements established with both the introduction of new DOCSIS 3.1 features and enhancements to management capabilities that are designed to improve operational efficiencies for the MSO.

Table 5-1 summarizes the new requirements that support new DOCSIS 3.1 features and the enhancements to existing management features. The table shows the management features along with the traditional Network Management Functional areas (Fault, Configuration, Accounting, Performance and Security) for the Network Elements (NE) CCAP and the corresponding OSI layer where those features operate.

Table 5-1 - Management Feature Requirements for DOCSIS 3.1

Features	Management Functional Area	OSI Layer	Description
OFDM downstream signals and OFDMA upstream signals	Configuration	PHY	Provisioning physical downstream and upstream interfaces that support OFDM transmitters/OFDMA receivers according to their capabilities

Features	Management Functional Area	OSI Layer	Description
Plant Topology	Configuration	PHY, MULPI, (Data Link)	Provisioning flexible arrangements of US/DS channels for channel bonding configuration to reflect HFC plant topology
Enhanced Diagnostics	Fault	PHY, MULPI, Network	Expanded metrics for Proactive Network Maintenance
Enhanced Performance Data Collection	Performance	PHY, MULPI, Network	Collection of large statistical data sets for DOCSIS 3.1 feature sets
Enhanced Signal Quality Monitoring	Performance	PHY	To gather information on narrow band ingress and distortion affecting the quality of the RF signals
Light Sleep Mode	Configuration	MULPI	Energy efficiency mode for the Cable Modem to minimize power consumption
Backup Primary Channels	Configuration	MULPI	Retrieval of configuration status of backup downstream interfaces
Active Queue Management (AQM)	Configuration	MULPI	Configuration of buffer management associated with service flows
Hierarchical Quality of Service (HQoS)	Configuration	MULPI	Configuration of hierarchical quality of service

### 5.3.1 Fault Management Features

The DOCSIS 3.1 Fault Management requirements include:

- Extended lists of detailed events related to the new set of DOCSIS 3.1 features.
- Expanded metrics for Proactive Network Maintenance.

### 5.3.2 Configuration Management Features

The configuration of the DOCSIS protocols for CM/CCAP interactions for configuring features in support of PHY MULPI/QoS and Security (BPI) uses the CM configuration file and CMTS policies via MAC messages exchange. The reporting of configuration state and status information is done via SNMP MIB objects. Configuration of features and functions of the CCAP is performed via XML configuration files.

The DOCSIS 3.1 configuration requirements include:

- Updates to CCAP configuration parameters to support OFDM downstream interfaces, OFDMA upstream interfaces, DOCSIS Light Sleep mode (DLS), Hierarchical QoS (HQoS), and Active Queue Management (AQM).
- Retrieval of configuration status information for OFDM downstream interfaces, OFDMA upstream interfaces, DOCSIS Light Sleep mode (DLS), Backup Primary Channels and Active Queue Management (AQM).

### 5.3.3 Performance Management Features

The DOCSIS 3.1 performance management requirements include:

- DOCSIS 3.1 requires an efficient mechanism for collecting large data sets as described above. The identified data set is: Enhanced signal quality monitoring for granular plant status.

## 5.4 Information Models

The Information Model approach is based on an object oriented modeling approach well known in the industry for capturing requirements and analyzing the data in a protocol independent representation. This approach defines requirements with use cases to describe the interactions between the operations support systems and the network element. The management information is represented in terms of objects along with their attributes and the

interactions between these encapsulated objects (or also referred to as entities in some representations). The diagrams developed to capture these managed objects and their attributes and associations are UML Class Diagrams. The collection of UML Class Diagrams and Use Case Diagrams are referred to as the DOCSIS 3.1 Information Models. With the introduction of several new, complex features in DOCSIS 3.0 and DOCSIS 3.1 and the operator needs for a more proactive and efficient approach to management information, information modeling methodologies offer the ability to reuse the same definitions when new protocols are introduced in the future.

The managed objects are then represented in a protocol specific form referred to as a management data model. The management data models when using SNMP are described using the Structure of Management Information Version 2 (SMIV2) [RFC 2578] and the design of these models is determined by the capabilities of the protocol. The management data models when using NETCONF are described using the YANG data modeling language [RFC 6020]. The management data models when using IPDR/SP are described using the IPDR Service Definition Schemas [IPDR/SSDG]. The management data models when using XML configuration file download are described using XML Schema [W3 XSD1.0].

Refer to Appendix VII for information modeling concepts used throughout this specification.

## 6 CONFIGURATION MANAGEMENT

DOCSIS 3.0 introduced a new methodology and approach for configuration management in the CCAP by moving away from using the SNMP interface to using an XML-based methodology as described in this section.

In addition to the XML-based approach to modify the attribute values stored in the CCAP, vendor-specific methods such as a Command Line Interface (CLI) or an HTTP interface could be present. Irrespective of the method used, it is necessary to assure the data integrity as a result of changes performed using different interfaces. For example when the attribute value is modified using one management interface, this changed value is reported when that attribute is accessed from any of the other interfaces. When a change in the value of the attribute does not succeed, requesting the same change from another interface also results in failure (assuming the same level of access control for all those interfaces for the specific operation). If an event is generated as a result of making the change in one management interface, this is reported independent of how the change was initiated.

### 6.1 CCAP Configuration Theory of Operation

The CCAP combines the functionality of an EQAM with a CMTS. While these are distinct functions, the configuration of the CCAP will treat these functions in a consolidated way. To facilitate the configuration of such a complex and dense device, this specification describes two methods for configuring the device:

- Processing of an XML-based configuration file transferred to the device and executed locally
- Configuring the device via the NETCONF protocol

Aspects of CCAP configuration include:

- Standard data model for configuration, with vendor-specific extensions for the inclusion of proprietary features
- XML-based configuration file
- Ability to configure a full set of standardized and vendor-proprietary configuration elements
- Ability to configure a partial set of standardized and vendor-proprietary configuration elements
- Light-weight protocols for transferring configuration files to and from the CCAP for XML-based file configuration
- NETCONF options to manage the CCAP configuration

It is anticipated that the CCAP will contain only basic default settings in its startup configuration when initially powered on, and the operator will begin configuration of the CCAP via serial console connection. Basic default settings are vendor-specific. The following sections define standardized CCAP configuration mechanisms and processes.

### 6.2 CCAP Configuration and Transport Protocol Requirements

#### 6.2.1 Configuration Object Datastore

The CCAP implements the standard configuration objects defined by this specification.

These configuration objects control CCAP behavior and, along with any vendor-proprietary configurations, are referred to as the "running-config".

The CCAP MUST provide a method for saving the state of the running-config to non-volatile memory. For NETCONF-based configuration, the NETCONF "copy-config" operation protocol provides this mechanism. However, for XML file-based configuration, this mechanism will be vendor-specific.

The configuration objects stored in non-volatile memory are referred to as the "startup-config".

## 6.2.2 DHCP Relay Agent Requirements

The CCAP MUST support the configuration of the relay function of the Dynamic Host Configuration Protocol, as specified in [MULPIv3.1].

The CCAP MUST support the ability to be configured with multiple concurrent DHCPv6 server addresses for routing mode operation.

If no DHCPv6 server addresses are configured on the CCAP, the CCAP SHOULD forward upstream DHCPv6 messages out of its network side interfaces to the DHCPv6 multicast group.

The CCAP MUST support configuration of at least four distinct DHCP helper addresses, so that devices such as CMs, MTAs, and CPE can be directed to separate DHCP servers by a CCAP operating in non-routing mode.

The CCAP MUST support the configuration of relay agent and VIVSO options. This does not imply that all DOCSIS features of the CCAP need to be governed by this setting.

The CCAP MUST support the CableLabs DHCPv6 VIVSO option for CM MAC address in RELAY-FORW. This is the equivalent of DHCPv4 option 82 remote-id for both CM and CPE.

The CCAP MUST support the ability to configure the throttling rate of DHCP renews (unicast) to abate flooding of the DHCP server for routing mode operation.

## 6.2.3 Dynamic Management of QAMs

When the downloaded configuration file contains updates to the QAM channel parameter configuration, the CCAP can send an ERMI-1 UPDATE message with a Service Status indicating "maintenance mode" for the particular QAM channel(s) affected. Once there are no active dynamic sessions and no traffic on the static UDP ports for each QAM channel, the channel is taken down, updates made, and then brought up and advertised with a new UPDATE.

For details, refer to the EQAM Dynamic Provisioning section of [PMI].

There can be a minimum number of preconfigured QAMs for DOCSIS and an additional set of channels that are demand based. When demand is low, those additional channels are available for other services. Conversely, when demand is high, more of these resources are assigned to DOCSIS, up to a configurable limit.

### 6.2.3.1 Dynamic Assignment of SDV/VOD QAMs

The ERM will control QAMs for SDV and VOD.

## 6.2.4 Video Configuration Requirements

The CCAP MUST enable adjustability of the size of the de-jitter buffer.

## 6.2.5 DOCSIS Configuration Requirements

The CCAP MUST support the configuration of blocked bandwidth limits.

The CCAP MUST support the ability to configure Concatenation (configurable on/off for each MAC domain, for pre-DOCSIS 3.0 modems, MAC wildcard).

The CCAP MUST support the ability to configure Fragmentation (configurable on/off for each MAC domain, for pre-DOCSIS 3.0 modems, MAC wildcard).

The CCAP MUST support the ability to configure enabling/disabling IPv6 provisioning mode via the DOCSIS MDD message.

The CCAP MUST support the ability to configure steering a modem to a different CMTS or CCAP based on TLV 43.11 - Service Type Identifier per [MULPIv3.1].



## 6.3 CCAP XML File-Based Configuration

### 6.3.1 CCAP XML Configuration File Theory of Operation

The CCAP will be configurable via the execution of an XML-based configuration file that holds the configuration details for the platform. The XML configuration files are conformant to the XML schemas based on the CCAP configuration object model specified in this document. A given XML configuration file for the CCAP platform is expected to be validated against these schemas.

The use case for configuring a CCAP with an XML configuration file is depicted in Figure 6-1.

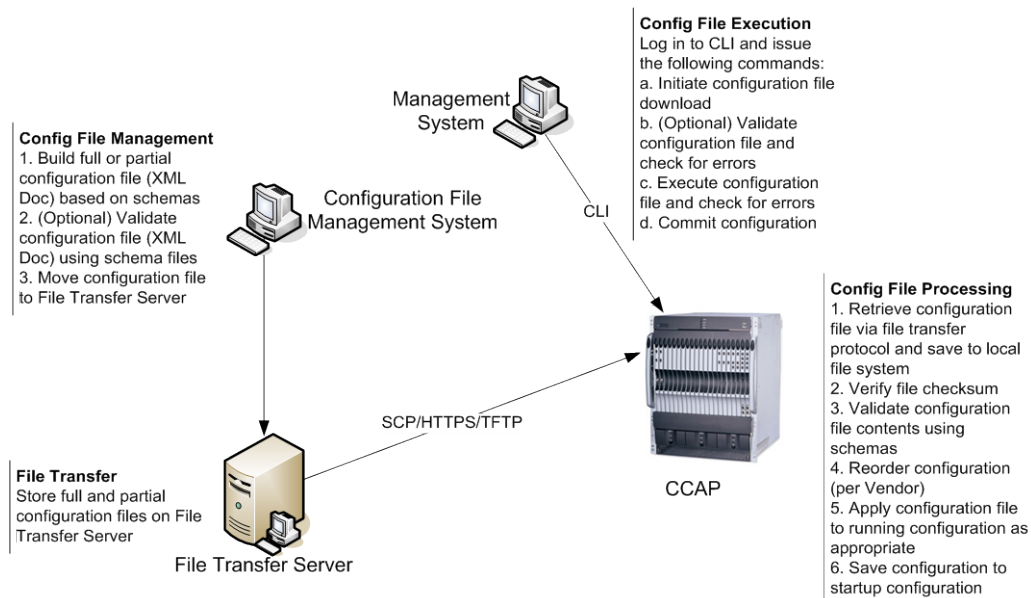

**Figure 6-1 - CCAP XML File-Based Configuration Use Case**

The CCAP parses and processes XML configuration files that are stored locally. These files are generated by processes and systems out of scope for this specification. Operators place XML configuration files in CCAP local storage via file transfer. Before executing an XML configuration file, the CCAP verifies that it has not been corrupted in the file transfer process. The XML configuration file is then validated against the configuration file schema to ensure that the configuration is valid. This validation step can also be performed independent of configuration file execution.

The CCAP parses the entire XML configuration file and processes the configuration objects represented in the file in a vendor-proprietary manner. The CCAP allows partial execution of configuration files; invalid configuration instructions can be ignored while valid instructions will still be processed. The CCAP can also reject configuration instructions if they cannot be met by the capabilities of the hardware present.

The CCAP XML configuration file process is defined in the following sections.

### 6.3.2 CCAP XML Configuration Files

The CCAP MUST support the use of an XML configuration file to set the values of standard CCAP configuration objects. A CCAP XML configuration file is an XML UTF-8 text representation of the keysets and attribute values of a set of configuration objects.

The CCAP MUST support the processing of an XML configuration file, which includes configuration elements that are related to hardware that is not installed in the CCAP chassis at the time of processing to allow for pre-provisioning.

Many configuration objects in the CCAP XML configuration file are nested within other configuration objects. The configuration file can contain the full hierarchy of elements where all element contexts are explicit. For an example of a configuration in a nested hierarchy, see Appendix I.1, CCAP XML Configuration File.

This specification makes use of the unified modeling language (UML) to define the common configuration elements of a CCAP. XML schemas and YANG modules are based on the CCAP configuration UML object model.

The CCAP MUST support an XML configuration file that is conformant to the most recent version of the following XML schema: `ccap@yyyy-mm-dd.xsd`, where yyyy-mm-dd represents the date on which the most recent version of the schema was published.

This schema is available at the following location: <http://www.cablelabs.com/YANG/DOCSIS>.

A single XML configuration file - containing both standard as well as vendor-proprietary elements - will be delivered to the CCAP. The file makes use of both the standard and vendor-proprietary namespaces. An XML configuration file may include proprietary extensions targeting multiple vendors. While validating or executing the configuration file, the CCAP is expected to ignore proprietary extensions it does not support.

The CCAP MUST only accept an XML configuration file if it indicates the version number(s) of the schemas/modules for which the file is intended to be conformant.

### 6.3.3 XML Configuration File Checksum

When the XML configuration file is downloaded or uploaded between the CCAP and a remote host, there exists a possibility that contents of the file may get corrupted or lost during a transfer.

The CCAP MUST provide a POSIX-compliant MD5 "checksum" command used to verify the integrity of a downloaded XML configuration file.

The operator can compare the output of the checksum command for the file on the CCAP with that of a checksum command on the remote host where the configuration file originated to confirm that the file has not been altered or corrupted.

### 6.3.4 XML Configuration File Validation

Before attempting to execute a given XML configuration file on a CCAP, the operator might want to first validate the file against the XML schemas supported.

On a CCAP, it is anticipated that the operator will attempt to validate an XML configuration file that contains elements belonging to schemas of a single CCAP vendor. Note that even when an XML configuration file is successfully validated, errors could still be encountered when the same file is later executed by the operator.

The CCAP MUST support a CLI command to validate an XML configuration file located on a local file system against the XML schemas supported by the software running on the CCAP.

The CCAP validate command MUST validate that the XML configuration file is well-formed XML.

The CCAP validate command SHOULD also check the XML configuration file for the following:

- References to undefined configuration data
- Attribute value constraints
- Resource constraints

When an XML configuration file successfully validates, the CCAP MUST log an event with severity level "Info" (Event ID: 70000103).

When the validation of the XML configuration file experiences errors, the CCAP MUST create a validation output log file to be stored on a local file system.

The CCAP MUST name the validation output log file such that the name contains the configuration file name (e.g., `<XML configuration file name>-<user>-<time>-validate.log`.) and is different from the filename of the execution output log file defined in Section 6.3.6.

When the validation of the XML configuration file experiences any error, the CCAP MUST include the following fields for each error entry, separated by a semi-colon (;), in the validation output log file:

- line number of the error
- configuration element, including namespace
- error message

When an XML configuration file fails to validate, the CCAP MUST provide an error message to the user via the user interface (regardless of the type of terminal session in use by the user), log an event with severity level "Notice" (Event ID: 70000104), and log the errored lines to the validation output log file as defined above.

### 6.3.5 XML Configuration File Execution Command and NETCONF Operations

Since the XML Configuration File downloaded to the CCAP is not automatically executed by the CCAP, it is necessary to define a CCAP CLI command to perform specific parsing and execution actions on a given XML Configuration File.

The CCAP MUST support a CLI command to execute a full XML configuration file located on a local file system, where the CCAP executes the operations specified for each element in the file.

The CCAP MUST support a CLI command to execute a partial XML configuration file located on a local file system, where the CCAP executes the operations specified for each element in the file.

The CCAP MUST support the "merge", "replace", and "delete" operations defined in section 7.2 of [RFC 6241]. This specification does not intend to make use of the "create" operation.

All configuration changes of an XML file are conceptually executed simultaneously, without regard to the order of the individual object operations in the file. The actual execution of an XML configuration file is expected to be implemented as a sequence of individual element operations in a vendor-specific order. Individual element operations can succeed or fail; the CCAP will log unsuccessful element operations.

The CCAP MUST NOT reject a configuration object because it is dependent upon or related to a configuration object that occurs later in the configuration file and has not yet been processed.

For example, it is valid to execute an XML configuration file that contains an object\_A that refers to a new object\_B, when the object\_A reference appears earlier in the file than the creation of object\_B.

A "Full" XML configuration file is one that is intended to replace the entire set of configuration objects on the CCAP.

A Full XML configuration file will contain the operation="replace" attribute in the <ccap:ccap> tag at the root of the configuration tree. When the CCAP saves or exports the current running-config or the startup-config to an XML format, the CCAP MUST insert operation="replace" in a single top-level <ccap:ccap> tag.

A "Partial" XML configuration file is one that is intended to augment the current running-config, replace a subset of the configuration objects on the CCAP, or to act on "control" objects (such as objects that allow a log to be reset or a diagnostic mode to be enabled).

A Partial XML configuration file will contain all of the parent object containers for the objects being configured, all the way up the configuration hierarchy to the "ccap" container. Because of this, caution is to be taken when using the "replace" or "delete" operations. While a "merge" operation will only update the attributes that are explicitly provided in the XML configuration file, the "replace" and "delete" operations act upon all objects within the configuration tree. This could cause the entire device configuration to be deleted.

A Partial XML configuration file using a merge or delete operation may exclude mandatory configurable attributes if they are not a key for the configuration object being acted upon. When a partial configuration is using a merge or delete operation, the CCAP MUST ignore validation errors related to missing mandatory configuration attributes unless the missing attribute is the key for the configuration object being acted upon.

The following is an example of how to use the merge operation to update the configuration of a QAM channel on an existing downstream RF port. The file would have the following structure:<sup>5</sup>

```
<ccap:ccap xmlns:xsi="http://www.w3.org/2001/XMLSchema-instance" SchemaVersion="2013-04-04"
xsi:schemaLocation="urn:cablelabs:params:xml:ns:yang:ccap ccap@2013-04-04.xsd"
xmlns:ccap="urn:cablelabs:params:xml:ns:yang:ccap" operation="merge">
  <chassis>
    <slot>
      <slot-number>1</slot-number>
      <rf-line-card>
        <ds-rf-port>
          <port-number>1</port-number>
          <down-channel>
            <channel-index>1</channel-index>
            <admin-state>up</admin-state>
            <power-adjust>4096</power-adjust>
            <frequency>200</frequency>
            <rf-mute>>false</rf-mute>
            <qam-alias>tnt</qam-alias>
            <erm-advertising>>false</erm-advertising >
          </down-channel>
        </ds-rf-port>
      </rf-line-card>
    </slot>
  </chassis>
</ccap:ccap>
```

Note when performing a merge or delete operation on a partial configuration file, only the attributes that define which instance is being configured are required; in the previous example the following attributes had to be specified:

- slot-number attribute of the slot object
- port-number attribute of the downstream-port object
- channel-index attribute of the down-channel object

As stated earlier, caution should be used with the delete and replace functions. If the replace operation were used in the place of the "merge" operation in the previous example, the entire ccap tree would be removed, replaced with abbreviated structure shown in the example. To avoid this, when using the replace operation, the operation should be placed within the element that is being acted upon. The following two examples demonstrate how the replace and delete operations can be used for targeted partial configuration updates.

#### Example XML for Replacing a DownChannel object:<sup>6</sup>

Note that all mandatory attributes of objects in the configuration tree are required when using a replace function; in this example a down-channel object is being replaced, but the mandatory attributes of line-card and downstream-port have to be included, even though they were already configured.

```
<ccap:ccap xmlns:xsi="http://www.w3.org/2001/XMLSchema-instance" SchemaVersion="2013-04-04"
xsi:schemaLocation="urn:cablelabs:params:xml:ns:yang:ccap ccap@2013-04-4.xsd"
xmlns:ccap="urn:cablelabs:params:xml:ns:yang:ccap" operation="replace">
  <chassis>
    <slot>
      <slot-number>1</slot-number>
      <rf-line-card>
        <rf-card>
          <line-card-name>DS RF 1</line-card-name>
          <admin-state>up</admin-state>
        </rf-card>
        <ds-rf-port>
          <port-number>1</port-number>
          <admin-state>up</admin-state>
          <down-channel>
            <channel-index>1</channel-index>
            <admin-state>down</admin-state>
            <power-adjust>0</power-adjust>
          </down-channel>
        </ds-rf-port>
      </rf-line-card>
    </slot>
  </chassis>
</ccap:ccap>
```

<sup>5</sup> Modified per CCAP-OSSv3.1-N-15.1384-2 on 11/10/15 by KB.

<sup>6</sup> Modified per CCAP-OSSv3.1-N-15.1384-2 on 11/10/15 by KB.

```

        <frequency>0</frequency>
        <rf-mute>>false</rf-mute>
        <qam-alias>String</qam-alias>
        <erm-advertising>>true</erm-advertising>
    </down-channel>
</ds-rf-port>
</rf-line-card>
</slot>
</chassis>
</ccap:ccap>

```

### Example XML for Deleting a DownChannel Object:

```

<ccap:ccap xmlns:xsi="http://www.w3.org/2001/XMLSchema-instance" SchemaVersion="2013-04-04"
xsi:schemaLocation="urn:cablelabs:params:xml:ns:yang:ccap_ccap@2013-04-04.xsd"
xmlns:ccap="urn:cablelabs:params:xml:ns:yang:ccap" operation="delete">
  <chassis>
    <slot>
      <slot-number>1</slot-number>
      <rf-line-card>
        <ds-rf-port>
          <port-number>1</port-number>
          <down-channel>
            <channel-index>100</channel-index>
          </down-channel>
        </ds-rf-port>
      </rf-line-card>
    </slot>
  </chassis>
</ccap:ccap>

```

The CCAP will support only one occurrence of the same NETCONF operation ("merge", "replace", or "delete") in a single file. If an operator needs to perform more than one operation type to configure the CCAP, separate configuration files will need to be created and the operator will execute those files sequentially.

If an XML configuration file does not contain one and only one explicit operation type value of "merge", "replace", or "delete", upon attempted execution of the file, the CCAP MUST reject the entire file, make no changes to the running-config, and log the fatal error as an event with a severity level "Warning" (Event ID: 70000108).

If the ccap:ccap node in the XML configuration file has a "replace" operation value, and the subtree in the XML configuration file for that node is missing one or more mandatory elements (either standard elements or vendor-extensions), then the CCAP MUST retain the mandatory elements, attempt the execution of the remaining elements in the file, and log the non-fatal errors as an event with a severity level "Error" (Event ID: 70000107).

The CCAP MUST allow the pre-provisioning of configuration objects associated with line cards that are not yet present in the chassis.

Note that if a "replace" operation value is used, and parts of the subtree in the XML configuration file are missing one or more non-mandatory (vendor-specific or standard) elements, then the CCAP deletes the absent non-mandatory elements from its running-config.

Conversely, for a "merge" operation, the CCAP MUST preserve both standard and vendor-extension objects in the affected subtree that are not present in the merged XML configuration file.

For a "delete" operation, the CCAP MUST delete both standard and vendor-extension objects in the affected subtree.

If an XML configuration file contains an explicit "create" operation value, upon attempted execution of the file the CCAP MUST reject the entire file, make no changes to the running-config, and log the fatal error as an event with a severity level of "Warning" (Event ID: 70000108).

### 6.3.6 XML Configuration File Parsing and Error Logging

Before a configuration file is applied to the CCAP, the CCAP performs several checks against the file. If the configuration file does not pass these checks, the CCAP will reject the file. The CCAP can also reject individual objects within the configuration file. In all rejection cases, the CCAP will log the rejection as an error.

When executed, the CCAP MUST verify that the configuration file is well-formed XML.

If the CCAP fails to verify the file is well-formed as part of an execution, the CCAP MUST reject the file, make no changes to the running-config, log the fatal error as an event with a severity level "Warning" (Event ID: 70000109), log the errored lines to the execution output log file in the format defined later in this section, and provide an error message to the user interface, regardless of the type of terminal session in use by the user.

If the module/schema version number contained within the executed XML configuration file is not compatible with the module/schema set supported by the CCAP, the CCAP MUST reject the file, make no changes to the running-config, log the fatal error as an event with a severity level "Warning" (Event ID: 70000109), log the line(s) where the module/schema version mismatch was detected to the execution output log file in the format defined later in this section, and provide an error message to the user interface, regardless of the type of terminal session in use by the user.

When the execution of the XML configuration file completes without error, the CCAP MUST log an event with severity level "Notice" (Event ID: 70000105).

When the execution of the XML configuration file completes without error, the CCAP MAY create an execution output log file containing execution time, user, and XML configuration filename information.

The CCAP supports "partial execution" of an XML configuration file, where certain elements in the file are successfully executed and other elements in the file are unable to be executed.

When the execution of the XML configuration file experiences errors, the CCAP MUST create an execution output log file to be stored on a local file system.

The CCAP MUST name the execution output log file such that the name contains the executed configuration file (e.g., <executed XML configuration file name>-<user>-<time>-out.log) and is different from the filename of the validation output log file defined in Section 6.3.4.

When the execution of the XML configuration file experiences any error, the CCAP MUST use a standard format for each error entry, separated by a semi-colon (;), in the execution output log file and include:

- line number of the error
- configuration element, including namespace
- error message

When an executed XML configuration file contains elements that are not supported by the CCAP, the CCAP MUST process the elements it does support, and log the non-fatal error as an event with severity level "Error" (Event ID: 70000106), and log the unsupported lines to the execution output log file as defined above.

The CCAP MUST perform the validate function as an initial step of the execute command before any changes are applied to the configuration store.

If the CCAP fails to validate the file as part of an execution, the CCAP MUST reject the file, make no changes to the running-config, log the fatal error as an event with a severity level "Warning" (Event ID: 70000109), log the errored lines to the execution output log file as defined above, and provide an error message to the user interface, regardless of the type of terminal session in use by the user.

If during the execution of a validated configuration file an error is encountered, the CCAP MUST apply the configuration of the non-errored elements, log the non-fatal error as an event with severity level "Error" (Event ID: 70000107), log the errored lines to the execution output log file as defined above, and provide an error message to the user interface, regardless of the type of terminal session in use by the user.

### 6.3.7 File Transfer Mechanisms

The CCAP will implement several file transfer mechanisms that can be used to "download" an XML configuration file or software image from an external host to the CCAP or "upload" a copy of an XML configuration file or software image to an external host.

The CCAP **MUST** support the Secure Copy Protocol (SCP) - based on Secure Shell version 2 - for both file download and upload operations.

The CCAP **MUST** support the initiation of Secure Copy download and upload operations from both a remote host and from the CCAP CLI.

The CCAP **MUST** support the Trivial File Transfer Protocol (TFTP), as specified in [RFC 1350], for both file download and upload operations.

Since TFTP has no inherent authentication mechanism, the CCAP **MUST** only support the initiation of Trivial File Transfer download and upload operations from the CCAP CLI by an authenticated and authorized user.

The CCAP **SHOULD** support Secure Hypertext Transfer Protocol (HTTPS) for both file download and upload operations.

The CCAP **SHOULD** support the initiation of HTTPS download and upload operations from both a remote host and from the CCAP CLI.

If HTTPS download initiation from a remote host is supported by the CCAP, the CCAP **MUST** implement TLS validation of the X.509 certificate presented by the remote host.

For both SCP and HTTPS file download and upload operations, the CCAP **MUST** support the ability to authenticate the file transfer connection via TACACS+ and RADIUS as well as usernames configured locally on the CCAP.

If an initiated file transfer fails, the CCAP **MUST** log an event with severity level "Error" (Event ID: 70000102) and provide an error message to the user interface indicating that the file transfer failed, regardless of the type of terminal session in use by the user.

#### 6.3.7.1 TLS for HTTPS

Authentication of the remote host server by the CCAP is performed by validating the certificate provided by the remote host during TLS setup.

The CCAP **MUST** negotiate TLS-related integrity protection and encryption features at the TLS layer.

The remote host will always offer TLS cipher suites to be used for the session, as specified in [RFC 5246].

The CCAP **MUST** decide which TLS cipher suites are used, as specified in [RFC 5246].

The CCAP **MUST** verify that the data is sent and received according to [RFC 5246]. This verification is also used to detect if the received data has been tampered with.

The CCAP **MUST** support the following TLS profiles (per [RFC 5246]):

- TLS\_RSA\_WITH\_3DES\_EDE\_CBC\_SHA
- TLS\_RSA\_WITH\_AES\_128\_CBC\_SHA

The use of NULL integrity protection and/or NULL encryption by the CCAP is not anticipated.

The remote host will present X.509 digital certificates, per [RFC 5280], for authentication in TLS, as profiled in Table 6-1.

**Table 6-1 - TLS Certificate Profile**

<b>TLS Server Certificates</b>	
Subject Name Form	C=<Country> O=<Company> CN=<FQDN> FQDN is the remote host's fully qualified domain name (e.g., es.example.com). Only a single FQDN is allowed in the CN field. Additional fields may be present in the subject name.
Intended Usage	These certificates are used to authenticate TLS handshake exchanges (and encrypt when using RSA key exchange).
Validity Period	Set by operator policy
Modulus Length	1024, 1536, 2048
Extensions	KeyUsage[critical](digitalSignature, keyEncipherment) extendedKeyUsage (id-kp-serverAuth, id-kp-clientAuth) authorityKeyIdentifier (keyIdentifier=<subjectKeyIdentifier value from CA cert>)

Remote host certificates will be issued by the cable operator.

The CCAP MUST verify that the remote host's TLS certificates are part of a certificate chain that chains up to the cable operator's certificate authority (CA).

If changes other than the certificate serial number, validity period and the value of the signature exist in the root certificate that was sent by the remote host to the CCAP in comparison to the known root certificate, the CCAP MUST conclude that the certificate verification has failed.

The CCAP MUST build the certificate chain and validate the TLS certificate according to the "Certificate Path Validation" procedures described in [RFC 5280].

### 6.3.8 Exporting the Configuration Object Data Store

The CCAP MUST support a CLI command to export the startup-config into an XML configuration file to be stored on local non-volatile storage.

The CCAP MUST support a CLI command to export the current running-config of the device to an XML Configuration File to be stored on local non-volatile storage.

The CCAP MUST support the export of XML configuration files in a format that conforms to the standard CCAP schema set, including optional vendor extensions.

The CCAP MUST allow the user to specify the full file system path and filename of the exported XML Configuration File.

The CCAP SHOULD support XML configuration file export operations with both concise and verbose options. The output of the concise export operation does not include optional attributes that are set to the default value/have not been configured. The output of the verbose operation does include these items.

When exporting to an XML configuration file, the CCAP MUST encrypt in a vendor-specific way the content of configuration items intended to be "secret", including, but not limited to:

- passwords (including lawful intercept)
- DOCSIS shared secret
- TACACS+ and RADIUS keys
- routing protocol keys

The CCAP MUST be able to import a previously exported configuration file containing encrypted attributes, where the configuration file was previously exported from that vendor's CCAP devices.

It is expected that encrypted attributes in an exported XML configuration file can be imported on another CCAP produced by the same vendor.



## 6.4 CCAP NETCONF-Based Configuration

### 6.4.1 NETCONF Theory of Operation

The CCAP may also support configuration via the NETCONF protocol. In this case configuration instructions are sent using XML-encoded remote procedure calls (RPCs) in NETCONF protocol messages from a configuration management tool to the CCAP. The XML configuration data, representing the CCAP configuration, is conformant to the YANG modules specified in this document.

The use case for configuring a CCAP via NETCONF is depicted in Figure 6-2.

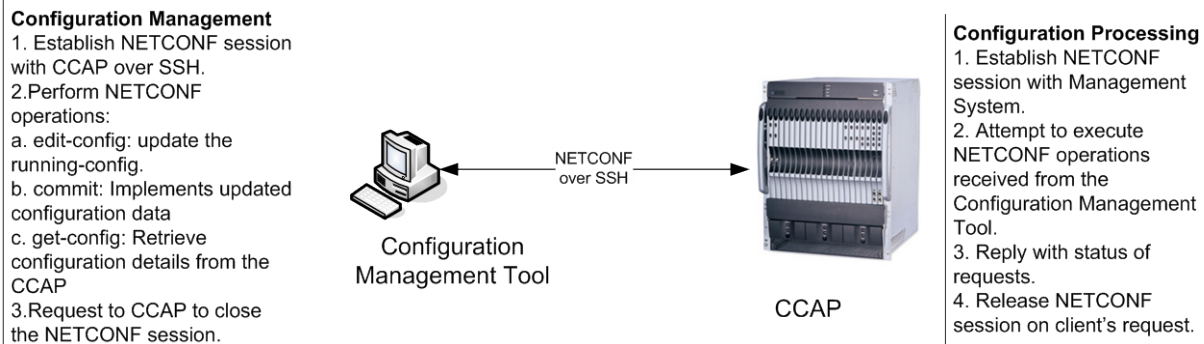

**Figure 6-2 - CCAP NETCONF-Based Configuration Use Case**

The YANG modules, based on the CCAP configuration object model, are implemented by the configuration management tool and the CCAP; these modules are used to generate valid configuration NETCONF operations and content from the management system and to validate and execute those operations and content on the CCAP.

When the configuration management tool begins the configuration process, an SSH session is set up between the configuration management tool and the CCAP being configured. The configuration management tool can then deliver full or partial CCAP configuration changes using NETCONF operations. The configuration content can be machine-generated or hand created; they are sent in the NETCONF RPC to the CCAP.

The CCAP receives, parses, and processes the configuration operations received via NETCONF from the configuration management tool. The CCAP can be fully or partially reconfigured; invalid configuration instructions can be ignored while valid instructions will still be processed. The CCAP can also reject configuration instructions if they cannot be met by the capabilities of the hardware present.

The CCAP can also respond to <get-config> operations from the configuration management tool and provide a full or partial XML-based representation of the current device configuration, delivered to the configuration management tool via NETCONF.

The CCAP NETCONF configuration process is discussed in the following sections.

### 6.4.2 NETCONF Overview

NETCONF [RFC 6241] is a configuration management protocol defined by the IETF. NETCONF provides mechanisms to install, manipulate, and delete the configuration of network devices.

NETCONF uses an XML-based data encoding for the configuration data as well as protocol messages. The protocol operations are realized on top of a simple Remote Procedure Call (RPC) layer. A client encodes an RPC in XML and sends it to a server using a secure, connection-oriented session. The server responds with a reply encoded in XML. The contents of both the request and the response are fully described using YANG ([RFC 6020]) allowing both parties to recognize the syntax constraints imposed on the exchange.

NETCONF is connection-oriented, requiring a persistent connection between peers. This connection is expected to provide reliable, sequenced data delivery. NETCONF connections are long-lived, persisting between protocol operations; the connection is also expected to provide authentication, data integrity, and confidentiality.

There are currently several transport mappings published, including SSHv2 [RFC 4742], SOAP [RFC 4743], BEEP [RFC 4744], and TLS [RFC 5539]. The SSH transport protocol mapping is mandatory to implement and the others are optional.

In addition to the XML file based configuration of the CCAP, it is expected that some vendors will provide a NETCONF option for configuring and managing a CCAP using the YANG module specified in [CCAP-CONFIG-YANG]. These modules are based on the CCAP configuration object model specified in Section 6.5.

### 6.4.3 NETCONF Requirements

The CCAP SHOULD implement NETCONF Server, as specified in [RFC 6241].

If the CCAP implements NETCONF Server, the base NETCONF capability identified by the urn:ietf:params:netconf:base:1.0 URN MUST be implemented; all remaining capabilities described in the RFC are optional.

Any NETCONF Server implemented in the CCAP MUST comply with the mandatory SSHv2 transport mapping specified in [RFC 4742].

If the CCAP supports NETCONF-based configuration, the CCAP MUST support the "merge", "replace", and "delete" operations defined in section 7.2 of [RFC 6241]. This specification does not intend to make use of the "create" operation.

If the CCAP supports NETCONF-based configuration, the CCAP MUST support the ccap.yang module defined in [CCAP-CONFIG-YANG].

If the CCAP supports NETCONF-based configuration, the CCAP SHOULD support the with-defaults Capability for NETCONF according to the 'report-all' basic mode, as defined in [RFC 6243]. A server that uses the 'report-all' basic mode does not consider any data node to be default data, even schema default data. If the CCAP supports NETCONF-based configuration, when a client retrieves data with a <with-defaults> parameter equal to 'report-all', the CCAP MUST report all data nodes, including any data nodes considered to be default data by the server. This is the equivalent of a "verbose" XML configuration file export.

## 6.5 CCAP Data Type Definitions

The following data types have been created to support the CCAP Information Models. See Annex F for the primitive and derived data types used in this model.

**Table 6-2 - Data Types<sup>7</sup>**

Data Type Name	Base Type	Type Constraints	Reference	YANG Data Type
AdminState	Enum	other(1), up(2), down(3), testing(4)	[RFC 2863]	admin-state-type
AttrAggrRuleMask	hexBinary	SIZE (4)	[MULPIv3.1]	
AttributeMask	EnumBits	bonded(0), lowLatency(1), highAvailability(2)	[MULPIv3.1]	attribute-mask-type
BitRate	Gauge32	0..4294967295		
ChannelList	hexBinary	SIZE (0..255)		

<sup>7</sup> Modified per CCAP-OSSv3.1-N-15.1307-3 on 6/1/15 by KB; per CCAP-OSSv3.1-N-15.1323-1 on 7/20/15 by KB; per CCAP-OSSv3.1-N-15.1390-2 on 11/11/15 by KB; per CCAP-OSSv3.1-N-16.1471-3 on 5/13/16 by KB; per CCAP-OSSv3.1-N-16.1544-2 on 11/16/16 by KB.

Data Type Name	Base Type	Type Constraints	Reference	YANG Data Type
ChChgInitTechMap	Enum	reinitializeMac(0) broadcastInitRanging(1) unicastInitRanging(2) initRanging(3) direct(4)	[MULPIv3.1]	
ChId	UnsignedByte	0..255	[MULPIv3.1]	
ChSetId	UnsignedInt	0..4294967295	[MULPIv3.1]	
CmtsCmRegState	Enum	other (1) initialRanging(2) rangingAutoAdjComplete (4) startEae (10) startDhcpV4 (11) startDhcpV6(12) dhcpV4Complete(5) dhcpV6Complete(13) startConfigFileDownload(14) configFileDownloadComplete(15) startRegistration(16) registrationComplete(6) operational (8) bpilnit (9) forwardingDisabled(17) rfMuteAll(18)	[MULPIv3.1]	
Dsid	UnsignedInt	0..1048575	[MULPIv3.1]	
DsOfdmCyclicPrefixType	UnsignedShort	( 192   256   512   768   1024)	[PHYv3.1]	
DsOfdmModulationType	Enum	other(1) zeroBitLoaded(2) qpsk(3) qam16(4) qam64(5) qam128(6) qam256(7) qam512(8) qam1024(9) qam2048(10) qam4096(11) qam8192 (12) qam16384 (13)	[PHYv3.1]	
DsOfdmSubcarrierSpacingType	UnsignedByte	( 25   50)	[PHYv3.1]	
DsOfdmWindowingType	UnsignedShort	( 0   64   128   192   256)	[PHYv3.1]	
HePidValue	UnsignedShort	(0..8191   65535)	[SCTE 154-5]	
Host	Choice of IpAddress or InetAddressName			host
HundredthdB	Integer			
ifDirection	Enum	downstream (1) upstream (2)		
IpAddress	InetAddress		[RFC 4001]	inet:ip-address
InetAddressPrefixLength	UnsignedByte	32 or 128 depending on IP version	[RFC 4001]	address-prefix-len- type
InetIpPrefix	Union of InetIpv4Prefix and InetIpv6Prefix		[RFC 6021]	inet:ip-prefix
InetIpv4Prefix	Union of InetAddressIpv4 and InetAddressPrefix Length	InetAddressPrefixLength: 32	[RFC 4001]	ipv4-prefix

Data Type Name	Base Type	Type Constraints	Reference	YANG Data Type
InetIpv6Prefix	Union of InetAddressIpv6 and InetAddressPrefix Length	InetAddressPrefixLength: 128	[RFC 4001]	ipv6-prefix
InetHost	Union of InetIpAddress and InetDomainName		[RFC 6021]	inet:host
InetPortNum	Short		[RFC 4001]	inet:port-number
IPHostPrefix	Union of IPv4HostPrefix and Ipv6HostPrefix			ip-host-prefix
Ipv4HostPrefix				ipv4-host-prefix
Ipv6HostPrefix			[RFC 4291]	ipv6-host-prefix
NodeName	String	SIZE(0..64)	[RFC 3411]	
PartialChannelType	EnumBits	fecErrorsDsProfile(0) fecErrorsNcpProfile(1) fecErrorsPlc(2)	[MULPIv3.1]	
PartialChanReasonType	Enum	none(0) dsOfdmProfileFailure(16) dpdMismatch(18) ncpProfileFailure(20) plcFailure(21)		
PartialServiceType	Enum	other(1) none(2) partialSvcDsOnlyImpaired(3) partialSvcUsOnlyImpaired(4) partialSvcDsAndUsImpaired(5)	[MULPIv3.1]	
PartialServiceReasonType	Enum	none(0) secondaryChanMddTimeout(1), lostFecLock(2)	[MULPIv3.1]	
PrimaryDsIndicatorType	Enum	other (1) primaryDsChannel (2) backupPrimaryDs (3) notSpecified(4)	[MULPIv3.1]	
QuarterdB	UnsignedByte			
RcpId	hexBinary	SIZE (5)	[MULPIv3.1]	
SchedulingType	Enum	undefined (1) bestEffort (2) nonRealTimePollingService (3) realTimePollingService (4) unsolicitedGrantServiceWithAD (5) unsolicitedGrantService (6)	[MULPIv3.1]	
TenthdB	Short		[RFC 4546]	
ThousandthdB	Integer			
TriggerFlag	EnumBits	registration(0) rangingRetry(1)		trigger-flag-type
UpDownTrapEnable	Boolean		[RFC 2863]	up-down-trap-enable
UsOfdmaCyclicPrefixType	Unsigned Short	(96   128   160   192   224   256   288   320   384   512   640)	[PHYv3.1]	

Data Type Name	Base Type	Type Constraints	Reference	YANG Data Type
UsOfdmaModulationType	Enum	other(1) zeroValued(2) bpsk(3) qpsk(4) qam8(5) qam16(6) qam32(7) qam64(8) qam128(9) qam256(10) qam512(11) qam1024(12) qam2048(13) qam4096(14)	[PHYv3.1]	
UsOfdmaWindowingSizeType	UnsignedByte	(0   32   64   96   128   160   192   224)	[PHYv3.1]	

### 6.5.1 AdminState

This data type defines the Admin state. The value of other(1) is used when a vendor extension has been implemented for this attribute.

Reference: [RFC 2863]

### 6.5.2 AttrAggrRuleMask

This data type represents a sequence of 32-bit positions that defines logical (e.g., AND, OR) operations to match against the channel list Provisioned Mask and Service Flow Required Mask bit positions when the CMTS is determining the service flow for assignment to a bonding group not configured by the management system.

Reference: [MULPIv3.1] Service Flow Assignment section.

### 6.5.3 AttributeMask

This data type consists of a sequence of 32-bit positions used to select the bonding group or the channel to which a service flow is assigned. DOCSIS defines three types of Attribute Masks for which this type applies: the Provisioned Attribute Mask that is configured to a Bonding Group or a single-channel, whereas the Required Attribute and the Forbidden Attribute Mask are part of the Service Flow QoS Parameter Set to be matched with the Provisioned Attribute Mask of CMTS-configured Bonding Groups or single-channels. DOCSIS reserves the assignment of the meaning of the first 16 bit positions (left to right) as follows:

Bit 0: bonded

Bit 1: lowLatency

Bit 2: highAvailability

Bit positions 3-15 are reserved.

Bit positions 16-31 are freely assigned by operators to represent their own constraints on the channel(s) selection for a particular service flow.

Reference: [MULPIv3.1] Service Flow Assignment section.

### 6.5.4 BitRate

The rate of traffic in units of bits per second.

### 6.5.5 ChannelList

This data type represents a unique set of channel IDs in either the upstream or the downstream direction. Each octet represents an upstream channel identifier (UCID) or a downstream channel identifier (DCID), depending on the direction of the channels within the list. The CCAP MUST ensure that this combination of channels is unique per direction within the MAC Domain.

A query to retrieve the value of an attribute of this type returns the set of channels in the channel list in ascending order of channel IDs.

### 6.5.6 ChChgInitTechMap

This data type enumerates the allowed initialization techniques for Dynamic Channel Change (DCC) and Dynamic Bonding Change (DBC) operations. The techniques are represented by the 5 most significant bits (MSB). Bits 0 through 4 map to initialization techniques 0 through 4.

Each bit position represents the internal associated technique as described below:

- 'reinitializeMac'  
Reinitialize the MAC
- 'broadcastInitRanging'  
Perform Broadcast initial ranging on new channel before normal operation
- 'unicastInitRanging'  
Perform unicast ranging on new channel before normal operation
- 'initRanging'  
Perform either broadcast or unicast ranging on new channel before normal operation
- 'direct'  
Use the new channel(s) directly without re-initializing or ranging

Multiple bits may be set to 1 to allow the CMTS to select the most suitable technique in a proprietary manner.

An empty value or a value with all bits in '0' means no channel changes allowed

References: [MULPIv3.1] Initialization Technique.

### 6.5.7 ChId

This data type is an 8-bit number that represents a provisioned DCID or a provisioned UCID. A channel ID is unique per direction within a MAC Domain. The value zero is reserved for use when the channel ID is unknown.

References: [MULPIv3.1] Upstream Channel Descriptor (UCD) section.

### 6.5.8 ChSetId

This data type is a CMTS-derived unique number within a MAC Domain used to reference a Channel Set within the CMTS. Values in the range of 1 to 255 define a single-channel Channel Set and correspond to either the DCID or an UCID of that channel. Values greater than 255 indicate a Channel Set consisting of two or more channels in the same direction within the MAC Domain. The value zero is reserved for use when the Channel Set is unknown.

References: [MULPIv3.1] Channel Bonding section.

### 6.5.9 CmtsCmRegState

This data type defines the CM connectivity states as reported by the CMTS.

References: [MULPIv3.1] Cable Modem - CMTS Interaction section.

The enumerated values associated with the CmtsCmRegState are:

- other  
'other' indicates any state not described below.
- initialRanging  
'initialRanging' indicates that the CMTS has received an Initial Ranging Request message from the CM, and the ranging process is not yet complete.
- rangingAutoAdjComplete  
'rangingAutoAdjComplete' indicates that the CM has completed initial ranging and the CMTS sends a Ranging Status of success in the RNG-RSP.
- startEae  
'startEae' indicates that the CMTS has received an Auth Info message for EAE from the CM.
- startDhcpV4  
'startDhcpV4' indicates that the CMTS has received a DHCPv4 DISCOVER message from the CM.
- startDhcpV6  
'startDhcpV6' indicates that the CMTS has received a DHCPv6 Solicit message from the CM.
- dhcpV4Complete  
'dhcpV4Complete' indicates that the CMTS has sent a DHCPv4 ACK message to the CM.
- dhcpV6Complete  
'dhcpV6Complete' indicates that the CMTS has sent a DHCPv6 Reply message to the CM.
- startConfigFileDownload  
'startConfigFileDownload' indicates that the CM has started the config file download. If the TFTP Proxy feature is not enabled, the CMTS may not report this state.
- configFileDownloadComplete  
'configFileDownloadComplete' indicates that the CM has completed the config file download process. If the TFTP Proxy feature is not enabled, the CMTS is not required to report this state.
- startRegistration  
'startRegistration' indicates that the CMTS has received a Registration Request (REG-REQ or REG-REQ-MP) from the CM.
- registrationComplete  
'registrationComplete' indicates that the CMTS has received a Registration Acknowledge (REG-ACK) with a confirmation code of okay/success.

- operational  
'operational' indicates that the CM has completed all necessary initialization steps and is operational.
- bpiInit  
'bpiInit' indicates that the CMTS has received an Auth Info or Auth Request message as part of BPI Initialization.
- forwardingDisabled  
'forwardingDisabled' indicates that the CM registration process was completed, but the network access option in the received configuration file prohibits the CM from forwarding.
- rfMuteAll  
'rfMuteAll' indicates that the CM is instructed to mute all channels in the CM-CTRL-REQ message from CMTS.

The following table provides a mapping of Pre-3.0 DOCSIS and DOCSIS 3.0 registration states as reported by CMTS.

**Table 6-3 - Pre-3.0 DOCSIS and DOCSIS 3.0/3.1 CMTS CM Registration Status Mapping**

Pre-3.0 DOCSIS (from docsIfCmtsCmStatusValue)	DOCSIS 3.0/3.1
other (1)	other (1)
ranging (2)	initialRanging(2)
rangingAborted (3)	
rangingComplete (4)	rangingAutoAdjComplete (4)
	startEae (10)
	startDhcpV4 (11)
	startDhcpV6(12)
ipComplete(5)	dhcpV4Complete(5)
	dhcpV6Complete(13)
	startConfigFileDownload(14)
	configFileDownloadComplete(15)
	startRegistration(16)
registrationComplete (6)	registrationComplete(6)
accessDenied (7)	
operational (8)	operational (8)
registeredBPIInitializing (9)	bpiInit (9)
	forwardingDisabled(17)
	rfMuteAll(18)
<b>Note:</b> There are additional states introduced in DOCSIS 3.0. The new states are given a higher enumeration value though they are intermediate states in the CM registration states.	

### 6.5.10 Dsid

This data type defines the 20-bit Downstream Service Identifier used by the CM for downstream resequencing, filtering, and forwarding. The value zero is reserved for use when the DSID is unknown or does not apply.

Reference: [MULPIv3.1] DSID Definition section.



### 6.5.11 DsOfdmCyclicPrefixType

This data type is defined to specify the five possible values for the number of samples in a downstream cyclic prefix ( $N_{cp}$ ). The cyclic prefix (in  $\mu\text{s}$ ) is converted into samples using the sample rate of 204.8 Msamples/s and is an integer multiple of:  $1/64 * 20 \mu\text{s}$ .

Reference: [PHYv3.1] Table 7-34 - Cyclic Prefix (CP) Values

### 6.5.12 DsOfdmModulationType

This data type is defined to specify the modulation types supported by the CCAP modulator. The value of zeroBitLoaded means that the subcarrier is BPSK modulated.

Reference: [PHYv3.1] Modulation Formats section

### 6.5.13 DsOfdmSubcarrierSpacingType

This data type defines the subcarrier spacing. In the downstream direction, if the spacing is 50 kHz, then the FFT length is 4K, and if the spacing is 25 kHz, then the FFT length is 8K.

Reference: [PHYv3.1] Table 7-1 - Downstream OFDM parameters

### 6.5.14 DsOfdmWindowingType

This data type is defined to specify the five possible values for the downstream windowing roll-off period samples. The Roll-Off Period Samples are given in number of samples per roll-off period ( $N_{RP}$ ).

Reference: [PHYv3.1] Roll-off Period (RP) Values Table

### 6.5.15 HePidValue

This data type represents a packet identifier (PID) value which ranges from 0 to  $(2^{13} - 1)$ . The value of 65535 indicates that either the PID is invalid or does not exist.

Reference: [SCTE 154-5]

### 6.5.16 Host

The Host data type represents either a strongly-typed IP address or a DNS domain name. Use of this type avoids the weak validation inherent in the union-based inet:host type, as with this type an ip-address cannot be inappropriately validated as a domain-name accidentally. For a particular use of this data type, the CCAP MAY support only one of these choices: either an IP address or an FQDN.

For attributes with the Host data type, the CCAP MUST support configuring an IP address. For attributes with the Host data type, the CCAP SHOULD support configuring an FQDN.

### 6.5.17 HundredthdB<sup>8</sup>

The HundredthdB data type represents power levels that are normally expressed in dB. Units are in hundredths of a dB. For example, 5.17 dB will be represented as 517 when the data type is HundredthdB.

### 6.5.18 ifDirection

Indicates a direction on an RF MAC interface. The value downstream(1) is from CCAP to CM. The value upstream(2) is from CM to CCAP.

Reference: [MULPIv3.1] Terms and Definitions section.

---

<sup>8</sup> Added per CCAP-OSSiv3.1-N-15.1390-2 on 11/11/15 by KB.

### 6.5.19 IpAddress

The IpAddress data type refers to the InetAddress textual convention defined in [RFC 4001]. It is an octet string of length 4 for an IPv4 address and of length 16 for an IPv6 address. An object of type InetAddress is always interpreted in the context of an object of InetAddressType that selects whether the InetAddress is IPv4 or IPv6.

Reference: [RFC 4001]

### 6.5.20 InetAddressPrefixLength

This data type corresponds to the InetAddressPrefixLength textual description defined in [RFC 4001]. It is the number of contiguous "1" bits from the most significant bit of an InetAddress.

Reference: [RFC 4001]

### 6.5.21 InetIpPrefix

This data type is a union of InetIpv4Prefix and InetIpv6prefix and represents an IP prefix. It is IP version neutral. The format of the textual representations implies the IP version.

### 6.5.22 InetIpv4Prefix

This data type is a union of the InetAddressIpv4 and InetAddressPrefixLength textual conventions defined in. It corresponds to the ipv4-prefix data type defined in [RFC 6021].

Reference: [RFC 4001]

### 6.5.23 InetIpv6Prefix

This data type is a union of the InetAddressIpv6 and InetAddressPrefixLength textual conventions defined in [RFC 4001]. It corresponds to the ipv6-prefix data type defined in [RFC 6021].

Reference: [RFC 4001], [RFC 6021]

### 6.5.24 InetPortNum

The value in this data type represents the port number configured.

Reference: [RFC 4001]

### 6.5.25 InetHost

This data type represents a FQDN, or IPv4 address or IPv6 address and a port number.

Reference: [RFC 6021]

### 6.5.26 IPHostPrefix

This data type represents an IP host address plus prefix and is IP version neutral. The format of the textual representations implies the IP version. This type is similar to inet:ip-prefix.

This data type is the union of the Ipv4HostPrefix data type and the Ipv6HostPrefix data type.

### 6.5.27 Ipv4HostPrefix

This data type represents an IPv4 host address plus the prefix length, separated by a slash. The prefix length is given by a number less than or equal to 32 following the slash character. A prefix length value of n corresponds to an IP address mask that has n contiguous 1-bits from the most significant bit (MSB) and all other bits set to 0.

This type is derived from the `inet:ipv4-prefix` type, which has all bits of the IPv4 address set to zero that are not part of the IPv4 prefix. Use of that type requires separate configuration of the interface host address.

The pattern for this looks like: `((([0-9][1-9][0-9]1[0-9][0-9]2[0-4][0-9]25[0-5]),.) {3} ([0-9][1-9][0-9]1[0-9][0-9]2[0-4][0-9]25[0-5])/((([0-9])([1-2][0-9])(3[0-2])))`

### 6.5.28 Ipv6HostPrefix

This data type is derived from the `inet:ipv6-prefix` type, which has all bits of the IPv6 address set to zero that are not part of the IPv6 prefix. Use of that type requires separate configuration of the interface host address. The IPv6 address is represented in the compressed format described in [RFC 4291], section 2.2, item 2 with the following additional rules: the “:” substitution is applied to the longest sequence of all-zero 16-bit chunks in an IPv6 address. If there is a tie, the first sequence of all-zero 16-bit chunks is replaced by “::”. Single, all-zero 16-bit chunks are not compressed. The canonical format using lowercase characters and leading zeros are not allowed.

Reference: [RFC 4291]

The pattern for this looks like this:

```
((:[0-9a-fA-F]{0,4}):)([0-9a-fA-F]{0,4}:){0,5}' + '((([0-9a-fA-F]{0,4}):?([0-9a-fA-F]{0,4})))' + '(((25[0-5]2[0-4][0-9][01]?[0-9]?[0-9]),.) {3}' + '(25[0-5]2[0-4][0-9][01]?[0-9]?[0-9]))' + '(/((([0-9])([0-9]{2})(1[0-1][0-9])(12[0-8])))';
```

```
pattern '([[:^:]]+){6}([[:^:]]+:[[:^:]]+)(.*\..*)' + '([[:^:]]+)*[[:^:]]+?:([[:^:]]+)*[[:^:]]+?' + '(/.+);
```

### 6.5.29 NodeName

This data type is a human readable string that represents the name of a fiber node. Internationalization is supported by conforming to the SNMP textual convention `SnmpAdminString`. The US-ASCII control characters (0x00 - 0x1F), the DEL character (0x7F), and the double-quote mark (0x22) are prohibited within the syntax of this data type.

References: [RFC 3411]

### 6.5.30 PartialChannelType<sup>9</sup>

This data type enumerates each of the possible profiles or channel attributes which can contribute to an OFDM channel being considered a Partial Channel by the MAC layer. As more than one of these error conditions can exist at the same time this data type is based on EnumBits. The bits from low to high are:

Bit 0: fecErrorsDsProfile

Bit 1: fecErrorsNcpProfile

Bit 2: fecErrorsPlc

### 6.5.31 PartialChanReasonType<sup>10</sup>

This data type enumerates the CM-STATUS events which a CM can utilize to report a Partial Channel situation.

`none(0),`

`dsOfdmProfileFailure(16),`

`dpdMismatch(18),`

`ncpProfileFailure(20),`

<sup>9</sup> Added per CCAP-OSSiv3.1-N-15.1307-3 on 6/1/15 by KB; modified per CCAP-OSSiv3.1-N-16.1471-3 on 5/13/16 by KB.

<sup>10</sup> Added per CCAP-OSSiv3.1-N-15.1323-1 on 7/20/15 by KB; modified per CCAP-OSSiv3.1-N-16.1471-3 on 5/13/16 by KB; per CCAP-OSSiv3.1-N-16.1544-2 on 11/16/16 by KB.

plcFailure(21),

### 6.5.32 PartialServiceType<sup>11</sup>

This data type enumerates the type of channel issue which the MAC Layer indicates is causing the CM to be in DOCSIS 3.0 Partial Service mode. The possible values are as follows:

other(1)

none(2)

partialSvcDsOnlyImpaired(3)

partialSvcUsOnlyImpaired(4)

partialSvcDsAndUsImpaired(5)

### 6.5.33 PartialServiceReasonType<sup>12</sup>

This data type enumerates the CM-STATUS events which a CM can utilize to report a Partial Service situation.

none(0),

secondaryChanMddTimeout(1),

lostFecLock(2)

### 6.5.34 PrimaryDsIndicatorType

This data type enumerates the different type of Primary downstream channels. Possible values are:

- primaryDsChannel - when both the CM and CCAP are using DOCSIS 3.1 mode, this value indicates that the channel is the primary channel for the CM receiving this RCC. The CCAP MUST NOT use an RCC configuration having more than one primaryDsChannel when using DOCSIS 3.1 mode. When DOCSIS 3.0 mode is in use, this value indicates that the channel is primary-capable; multiple such channels are allowed in this mode.
- backupPrimaryDs - when both the CM and CCAP are using DOCSIS 3.1 mode, this value indicates that the channel is a backup primary channel for the CM receiving this RCC. The priority-ordered list of backup primary channels sent to the CM is the same order as the backupPrimaryDs channels are configured in RxChCfg. When DOCSIS 3.0 mode is in use, this value indicates that the channel is primary-capable; DOCSIS 3.0 does not support the backup primary channel feature.
- notSpecified - indicates that this channel has not been specified as a primary-capable channel.
- other - indicates a vendor-specific value.

References: [MULPIv3.1] Receive Channel Primary Downstream Channel Indicator section in the Common Radio Frequency Interface Encodings Annex.

### 6.5.35 QuarterdB<sup>13</sup>

The QuarterdB data type represents power levels that are normally expressed in dB. Units are in quarters of a dB.

The base data type is an unsigned byte where every bit of value is a quarter dB (e.g., a QuarterdB value of 0x5F represents 23.75 dB). The range is 0 to 63.5 dB in 1/4 dB steps. The value 0xFF is used to indicate no measurement is available for a given subcarrier. Any value over 63.5 dB is reported as 63.5 dB. Any value below 0 dB is reported as 0 dB.

---

<sup>11</sup> Added per CCAP-OSSIV3.1-N-15.1307-3 on 6/1/15 by KB.

<sup>12</sup> Added per CCAP-OSSIV3.1-N-15.1323-1 on 7/20/15 by KB

<sup>13</sup> Added per CCAP-OSSIV.31-N-15.1390-2 on 11/11/15 by KB.

Some attributes with a data type of QuarterdB choose to use HundredthdB with a quarter-dB accuracy for easier readability.

### 6.5.36 RcpId

This data type defines a 'Receive Channel Profile Identifier' (RCP-ID). An RCP-ID consists of a 5-octet length string where the first 3-bytes (from left to right) correspond to the Organizational Unique ID (OUI), followed by a two-byte vendor-maintained identifier to represent multiple versions or models of RCP-IDs.

References: [MULPIv3.1] RCP-ID section in the Common Radio Frequency Interface Encodings Annex.

### 6.5.37 SchedulingType

The scheduling service provided by a CMTS for an upstream Service Flow. This parameter is reported as 'undefined' for downstream QoS Parameter Sets.

Reference: [MULPIv3.1] Service Flow Scheduling Type section

### 6.5.38 TenthdB

This data type represents power levels that are normally expressed in dB. Units are in tenths of a dB; for example, 5.1 dB will be represented as 51.

Reference: [RFC 4546]

### 6.5.39 ThousandthdB<sup>14</sup>

The ThousandthdB data type represents power levels that are normally expressed in dB. Units are in thousands of a dB. For example, 5.175 dB will be represented as 5175 when the data type is ThousandthdB.

### 6.5.40 TriggerFlag

This data type defines the union of Diagnostic Log trigger types. Bit 0 represents the registration trigger, Bit 1 represents the ranging retry trigger.

### 6.5.41 UpDownTrapEnabled

Indicates whether linkUp/linkDown traps should be generated for this interface. This is a boolean type, where true means that the trap is enabled.

Reference: [RFC 2863], ifLinkUpDownTrapEnable

### 6.5.42 UsOfdmaCyclicPrefixType

This data type is defined to specify the eleven possible values for the number of samples in the upstream cyclic prefix ( $N_{cp}$ ). The cyclic prefix (in  $\mu\text{s}$ ) is converted into samples using the sample rate of 102.4 Msamples/s and is an integer multiple of:  $1/64 * 20 \mu\text{s}$ .

Reference: [PHYv3.1] Table 7-4 - Cyclic Prefix (CP) Values

### 6.5.43 UsOfdmaModulationType

This data type is defined to specify the modulation order of a given OFDMA subcarrier.

Reference: [PHYv3.1] Modulation Formats section

---

<sup>14</sup> Modified per CCAP-OSSiv3.1-N-16.1471-3 on 5/13/16 by KB

#### 6.5.44 UsOfdmaWindowingSizeType

This data type is defined to specify the eight possible values for the upstream windowing roll-off period samples. The Roll-Off Period Samples ( $N_{RP}$ ) are given in number of samples using the sample rate of 102.4 Msamples/s. Reference: [PHYv3.1] Table 7-5 - Roll-Off Period (RP) Values

### 6.6 UML Configuration Object Model

#### 6.6.1 CCAP UML Configuration Object Model Overview

The CCAP UML configuration object model, as well as the schemas based on that object model, have been divided into eight distinct groupings:

- **CCAP:** The Ccap object is the container of all CCAP configuration objects.
- **Chassis:** Consists of objects for configuring the hardware components of the CCAP.
- **Video:** Consists of those objects that are related to the EQAM functions of the CCAP, including ERM, encryption and decryption objects.
- **DOCSIS:** Consists of the DOCSIS configuration objects that are needed for configuring DOCSIS Mac Domains and services such as DSG.
- **Network:** Consists of objects related to configuring the core services for things like integrated servers, access lists, Syslog, HTTP, FTP, SSH, and other related network services.
- **Interfaces:** Consists of the objects needed to configure interfaces within the CCAP.
- **Management:** Consists of objects used to configure SNMP and Fault Management for the CCAP.
- **EPON:** Consists of the objects that are related to the DPoE configuration of the CCAP.

The CCAP configuration object model strives to make maximum re-use of existing SCTE HMS and OSSv3.0 MIBS and object models. In some cases these models were modified to address specific issues that were CCAP-related.

The CCAP supports the configuration objects defined in the following sections via implementation of the CCAP XSD.

##### 6.6.1.1 *Default Values and Mandatory Configuration of Attributes in the Configuration Object Model*

In the configuration object model attribute tables in the following sections, a default value is defined in the Default table column for some object attributes. In cases where a default value is defined for an element, the CCAP will use the specified default value if the XML configuration file does not include the attribute.

In cases where the Default column reads "vendor-specific", the CCAP MUST provide a default value of the vendor's choosing for the attribute in the implementation. In cases where the vendor is defining the default value, the operator need not include these attributes in the XML configuration file.

Attributes explicitly required in the XML configuration file are marked "Yes" in the Required Attribute column; these attributes do not have a default value. In these cases the operator needs to provide a value for these attributes in the XML configuration file when an object containing those attributes is being configured. In cases where the Required Attribute column reads "No", either a default value is provided in the table or the CCAP will provide a vendor-specific value.

##### 6.6.1.2 *Enumeration Values in the Configuration Object Model*

In the configuration object model attribute tables in the following sections, enumerated lists are all intended to begin at a value of "1"; in most cases, the first value will be other ("other(1)"). Since this specification borrows objects from existing MIBs, there will be cases where the enumeration values specified here do not match those of the MIB

on which the object attribute was based. CCAP vendors are expected to properly translate values provided in the XML configuration file into the correct values needed for SNMP reporting via the standard MIB objects.

Note that integers are specified for each enumeration in the UML configuration object model. When the UML is translated into other formats (XSD, YANG, SNMP, etc.), the enumeration labels and/or integers are included in these outputs as appropriate. For XSD and YANG, enumeration labels will be included.

### **6.6.1.3 Use of Interface Names in Configuration**

Several configuration objects defined in this specification are identified with keys in the form of a text string name. In general, these configuration objects are modeled after interfaces that have equivalent representation in SNMP (ifTable). While this specification does not impose formal requirements on the format of interface names, CCAP vendors are expected to implement consistent conventions for assigning textual names to interfaces and disclose the rules on which such conventions are based. The CCAP SHOULD reject a configuration that includes an interface name that does not follow the vendor's naming conventions.

### **6.6.1.4 Unconstrained Strings in the Configuration Object Model**

For object attributes with a data type of String, there are cases where this specification does not provide a length constraint. For these attributes, the CCAP MAY impose a vendor-specific length constraint. If a value in the XML configuration file exceeds this vendor-specific length constraint, the CCAP SHOULD truncate the text string to that limit. In addition, if a value in the XML configuration file exceeds this vendor-specific length constraint, the CCAP MUST log the non-fatal error as an event with severity level "Error" (Event ID: 70000107), log the errored lines to the execution output log file, and provide an error message that describes the vendor-specific length constraint and details how the string was handled (truncated, rejected, etc.).

## **6.6.2 Vendor-Specific Extensions**

A CCAP is expected to implement vendor-proprietary configuration objects beyond those defined in this specification. Standard objects are those that have been defined in the configuration UML object model, defined in the following sections. Vendor-proprietary configuration objects consist of both new configuration objects not represented in the CCAP configuration UML object model and new or modified attributes of configuration objects that exist in the CCAP configuration UML object model.

The CCAP's configuration object model can be extended via the creation of vendor-proprietary XSD schemas and/or vendor-proprietary YANG modules. A valid approach to vendor extensions is to perform extensions solely in XML schema utilizing the extension points in the standard schema (as described in Annex E) in conjunction with a vendor-defined schema. Vendor extensions can also be performed in YANG. A CCAP that supports vendor extension in YANG MUST support configuration via an XML configuration file based on an XSD schema that is the result of the conversion of the standard YANG module with extensions. Refer to Appendix IV for details on converting a YANG module to XSD.

Modifications to standard configuration objects are allowed within the specific rules defined in Annex E.

See Extending the Configuration Data Model in Annex E for requirements related to implementing vendor-specific extensions to the CCAP configuration. Annex E also specifies rules for modifications to standard configuration objects.

### 6.6.3 CCAP Configuration Objects

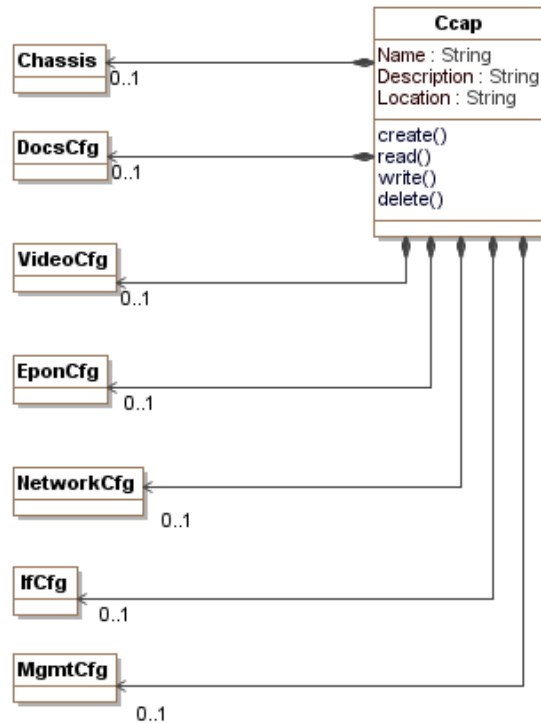

Figure 6-3 - CCAP Configuration Objects

#### 6.6.3.1 Ccap Object

The Ccap object serves as the root of the CCAP configuration data. It consists of three attributes that together describe the CCAP platform.

Table 6-4 - Ccap Object Attributes

Attribute Name	Type	Required Attribute	Type Constraints	Units	Default Value
Name	String	Yes	1..32		
Description	String	Yes			
Location	String	Yes	1..128		

Table 6-5 - Ccap Object Associations

Associated Object Name	Type	Near-end Multiplicity	Far-end Multiplicity	Label
Chassis	Directed composition to Chassis		0..1	
DocsCfg	Directed composition to DocsCfg		0..1	
VideoCfg	Directed composition to VideoCfg		0..1	
EponCfg	Directed composition to EponCfg		0..1	
NetworkCfg	Directed composition to NetworkCfg		0..1	
IfCfg	Directed composition to IfCfg		0..1	
MgmtCfg	Directed composition to MgmtCfg		0..1	



#### 6.6.3.1.1 *Ccap Object Attributes*

##### 6.6.3.1.1.1 Name

This attribute defines the name of the CCAP platform being configured.

##### 6.6.3.1.1.2 Description

This attribute contains the description of the CCAP platform.

##### 6.6.3.1.1.3 Location

This attribute contains any location information for the CCAP.

#### 6.6.3.2 **Chassis**

This configuration object is included in Figure 6-3 for reference. It is defined in Section 6.6.4.2, Chassis.

#### 6.6.3.3 **DocsCfg**

This configuration object is included in Figure 6-3 for reference. It is defined in Section 6.6.6.1.2, DocsCfg.

#### 6.6.3.4 **VideoCfg**

This configuration object is included in Figure 6-3 for reference. It is defined in Section 6.6.5.2, VideoCfg.

#### 6.6.3.5 **EponCfg**

This configuration object is included in Figure 6-3 for reference. It is defined in Section 6.6.10.2, EponCfg.

#### 6.6.3.6 **NetworkCfg**

This configuration object is included in Figure 6-3 for reference. It is defined in Section 6.6.7.2, NetworkCfg.

#### 6.6.3.7 **IfCfg**

This configuration object is included in Figure 6-3 for reference. It is defined in Section 6.6.8.2, IfCfg.

#### 6.6.3.8 **MgmtCfg**

This configuration object is included in Figure 6-3 for reference. It is defined in Section 6.6.9.2, MgmtCfg.

6.6.4 CCAP Chassis Objects

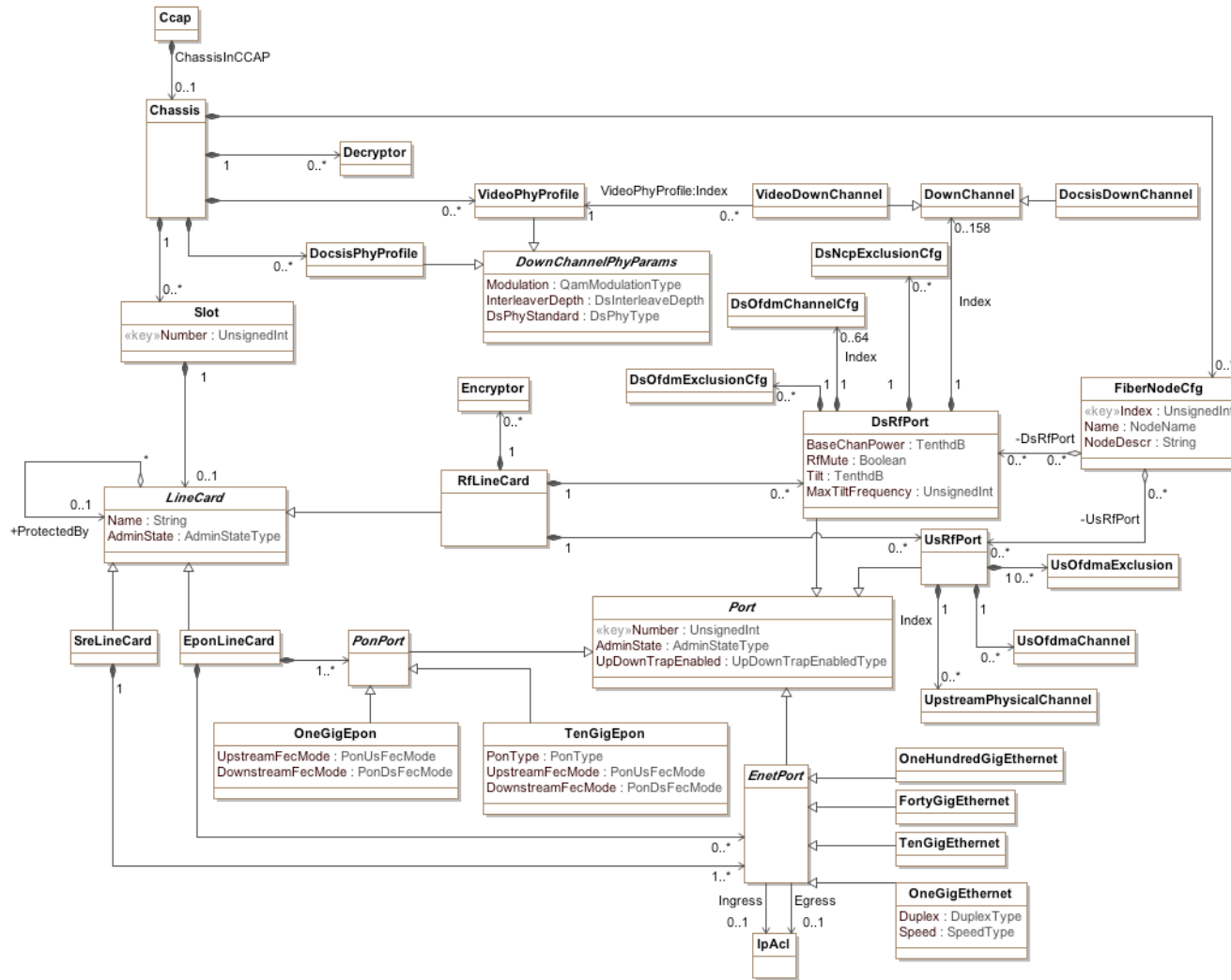

Figure 6-4 - CCAP Chassis Objects<sup>15</sup>

<sup>15</sup> Modified per CCAP-OSSv3.1-N-15.1307-3 on 6/1/15 by KB.

### 6.6.4.1 Ccap

This configuration object is included in Figure 6-4 for reference. It is defined in Section 6.6.3.1, Ccap Object.

### 6.6.4.2 Chassis

The Chassis object allows the user to configure the CCAP hardware elements. The Chassis object has the following associations.

**Table 6-6 - Chassis Object Associations**

Associated Object Name	Type	Near-end Multiplicity	Far-end Multiplicity	Label
Slot	Directed composition to Slot	1	0..*	
Decryptor	Directed composition to Decryptor	1	0..*	
FiberNodeCfg	Directed composition to FiberNodeCfg		0..*	
DocsisPhyProfile	Directed composition to DocsisPhyProfile		0..*	
VideoPhyProfile	Directed composition to VideoPhyProfile		0..*	

### 6.6.4.3 Decryptor

This configuration object is included in Figure 6-4 for reference. It is defined in Section 6.6.5.27, Decryptor.

### 6.6.4.4 Slot

This object configures a slot within the CCAP chassis. Line cards reside in slots.

**Table 6-7 - Slot Object Attributes**

Attribute Name	Type	Required Attribute	Type Constraints	Units	Default Value
Number	UnsignedInt	Yes (Key)	0..*		

**Table 6-8 - Slot Object Associations**

Associated Object Name	Type	Near-end Multiplicity	Far-end Multiplicity	Label
LineCard	Directed composition to LineCard	1	0..1	

#### 6.6.4.4.1 Slot Object Attributes

##### 6.6.4.4.1.1 Number

This attribute configures the slot number for which a LineCard object will be configured. The Number attribute is a zero- or one-based index that sequentially numbers the physical slots in the chassis. For example, the Slot numbers start at zero and increase to n-1, where n is the number of slots the chassis supports.

### 6.6.4.5 LineCard

The abstract object LineCard allows the user to define the common configuration elements for a CCAP line card. There are several types of line cards defined for the CCAP: Downstream (DLC), Upstream (ULC), System Route Engine (SRE), a combined Upstream and Downstream line card, and an EPON line card.

**Table 6-9 - LineCard Abstract Object Attributes**

Attribute Name	Type	Required Attribute	Type Constraints	Units	Default Value
Name	String	Yes			
AdminState	AdminState	No			down

Line card redundancy or sparing is achieved with a protect relationship between two line cards.

**Table 6-10 - LineCard Object Associations**

Associated Object Name	Type	Near-end Multiplicity	Far-end Multiplicity	Label
LineCard	Directed aggregation to LineCard	*	0..1	ProtectedBy

#### 6.6.4.5.1 LineCard Object Attributes

##### 6.6.4.5.1.1 Name

This attribute stores the name of the line card being configured.

##### 6.6.4.5.1.2 AdminState

This attribute sets the administrative state of the card.

#### 6.6.4.6 RfLineCard

This object holds the configuration data for a specific RF line card, either a downstream line card (DLC), an upstream line card (ULC), or a combined downstream/upstream line card. This object inherits all of the attributes of the LineCard abstract class. A Slot object contains one LineCard object associated with zero or one RfLineCard. A downstream RfLineCard contains one or more DsRfPort; an upstream contains one or more UsRfPort objects; an upstream/downstream RfLineCard contains both DsRfPorts and UsRfPorts. There are several associations for the RfLineCard.

**Table 6-11 - RfLineCard Object Associations**

Associated Object Name	Type	Near-end Multiplicity	Far-end Multiplicity	Label
LineCard	Specialization of LineCard			
Encryptor	Directed composition to Encryptor	1	0..*	
DsRfPort	Directed composition to DsRfPort	1	0..*	
UsRfPort	Directed composition to UsRfPort	1	0..*	
StaticUdpMapEncryption	Directed aggregation to StaticUdpMapEncryption	1	0..*	EnableEncryptionIndex

There are no specific attributes other than what is inherited from the above associations. A minimum lower frequency may be added in a future revision of this specification.

### 6.6.4.7 EponLineCard

This object configures an EPON line card.

**Table 6-12 - EponLineCard Object Associations**

Associated Object Name	Type	Near-end Multiplicity	Far-end Multiplicity	Label
LineCard	Specialization of LineCard			
PonPort	Directed composition to PonPort		1..*	
EnetPort	Directed composition to EnetPort		0..*	

### 6.6.4.8 SreLineCard

The SRE line card is the name given to the line card in the CCAP chassis that contains all the NSI and Management functions for the CCAP. This line card is associated with at least one EnetPort, which serves as the NSI. This object inherits all of the attributes of the LineCard abstract object. There are two associations for the SRE.

**Table 6-13 - SreLineCard Object Associations**

Associated Object Name	Type	Near-end Multiplicity	Far-end Multiplicity	Label
LineCard	Specialization of LineCard			
EnetPort	Directed composition to EnetPort	1	1..*	

### 6.6.4.9 Encryptor

This configuration object is included in Figure 6-4 for reference. It is defined in Section 6.6.5.34, Encryptor.

### 6.6.4.10 Port

The Port object is an abstract class from which all physical port objects on CCAP line cards are derived. There are no Port objects instantiated per-se in an XML instance file; only the derived physical port objects are instantiated. All physical port objects that derive from Port contain the attributes of a Port.

**Table 6-14 - Port Object Attributes**

Attribute Name	Type	Required Attribute	Type Constraints	Units	Default Value
Number	UnsignedInt	Yes (Key)	0..*		
AdminState	AdminState	No			down
UpDownTrapEnabled	UpDownTrapEnabled	No			false

#### 6.6.4.10.1 Port Object Attributes

##### 6.6.4.10.1.1 Number

The Number attribute of Port is a zero- or one-based index that sequentially numbers the physical ports of each derived type. For example, the port numbers of the DsRfPort objects start at zero and increase to n-1, where n is the total number of DsRfPorts.

##### 6.6.4.10.1.2 AdminState

This attribute configures the administrative state of the physical port.

6.6.4.10.1.3 UpDownTrapEnabled

This attribute configures whether linkUp/linkDown traps are enabled for this port.

**6.6.4.11 DsRfPort<sup>16</sup>**

This object allows for the configuration of a physical Downstream RF port on an RfLineCard. The DsRfPort is a type of the abstract class Port and inherits those common parameters. In the CCAP, a single port now encompasses the entire downstream spectrum instead of a few carriers as are seen in previous generation EQAM and CMTS products. A DsRfPort object contains the attributes in the following table.

**Table 6-15 - DsRfPort Object Attributes**

Attribute Name	Type	Required Attribute	Type Constraints	Units	Default Value
BaseChanPower	TenthdB	No		TenthdB	vendor-specific
RfMute	Boolean	No			false
Tilt	TenthdB	No	0..120	TenthdB	
TiltMaxFrequency	UnsignedInt	No		Hz	

**Table 6-16 - DsRfPort Object Associations**

Associated Object Name	Type	Near-end Multiplicity	Far-end Multiplicity	Label
Port	Specialization of Port			
DownChannel	Directed composition to DownChannel	1	0..158	Index
DsOfdmChannelCfg	Directed composition to DsOfdmChannelCfg	1	0..64	Index
DsNcpExclusionCfg	Directed composition to DsNcpExclusionCfg	1	0..*	
DsOfdmExclusionCfg	Directed composition to DsOfdmExclusionCfg	1	0..*	

6.6.4.11.1 DsRfPort Object Attributes

6.6.4.11.1.1 BaseChanPower

This attribute configures the base output power for each single channel (SC-QAM or OFDM) on the DsRfPort. The value is expressed in dBmV in units of TenthdB. The default value is vendor-specific. Acceptable power ranges for this attribute are defined in [PHYv3.1] in the Power per Channel CMTS or EQAM section.

Reference: [PHYv3.1], Power per Channel CMTS or EQAM section

6.6.4.11.1.2 RfMute

The attribute RfMute refers to a diagnostic state defined in the [PHYv3.1] Specification. Muting an RF port affects only the output power and does not impact the operational status of any channel on the port.

6.6.4.11.1.3 Tilt

This attribute configures the Tilt value to be applied over the supported downstream spectrum (from the minimum downstream frequency to the Tilt Maximum Frequency) on this DsRfPort.

Note: The amount of Tilt supported by a given CCAP is vendor-specific. The range provided here is not intended as a requirement on CCAP implementations as many implementations support a lower maximum Tilt value than is specified here.

6.6.4.11.1.4 Tilt Maximum Frequency

This attribute configures the maximum frequency (aka tilt pivot point) where the Tilt value applies.

<sup>16</sup> Section and subsections modified per CCAP-OSSv3.1-N-15.1307-3 on 6/1/15 by KB.

### 6.6.4.12 *FiberNodeCfg*

The *FiberNodeCfg* object defines the cable hybrid fiber/coax system (HFC) plant Fiber Nodes reached by RF ports on a CCAP.

This object supports the creation and deletion of multiple instances.

The CMTS and CCAP MUST persist all instances of *FiberNodeCfg* across reinitializations.

**Table 6-17 - *FiberNodeCfg* Object Attributes**

Attribute Name	Type	Required Attribute	Type Constraints	Units	Default Value
Index	UnsignedInt	Yes (Key)			
Name	NodeName	No			''''
NodeDescr	String	No			''''

The *FiberNodeCfg* object has the following associations.

**Table 6-18 - *FiberNodeCfg* Object Associations**

Associated Object Name	Type	Near-end Multiplicity	Far-end Multiplicity	Label
DsRfPort	Directed aggregation to DsRfPort	0..*	0..*	DsRfPort
UsRfPort	Directed aggregation to UsRfPort	0..*	0..*	UsRfPort

#### 6.6.4.12.1 *FiberNodeCfg* Object Attributes

##### 6.6.4.12.1.1 Index

This key represents the index of the fiber node being configured.

##### 6.6.4.12.1.2 Name

This attribute represents a human-readable name for a fiber node.

References: [MULPIv3.1] RF Topology Configuration section.

##### 6.6.4.12.1.3 NodeDescription

This attribute represents a human-readable description of the node.

### 6.6.4.13 *UsRfPort*

A *UsRfPort* object represents a physical upstream RF connector on an *RfLineCard*. It is derived from the *Port* abstract class, and so inherits all attributes of that class, including its associations. A *UsRfPort* is contained by an *RfLineCard*. It may contain one or more of the following objects:

- *UpstreamPhysicalChannel*
- *UsOfdmaChannel*
- *UsOfdmaExclusion*

This object has no attributes other than what has been inherited from the abstract class *Port*, but does have several associations.

**Table 6-19 - UsRfPort Object Associations**

Associated Object Name	Type	Near-end Multiplicity	Far-end Multiplicity	Label
Port	Specialization of Port			
UpstreamPhysicalChannel	Directed composition to UpstreamPhysicalChannel	1	0..*	
UsOfdmaChannel	Directed composition to UsOfdmaChannel	1	0..*	
UsOfdmaExclusion	Directed composition to UsOfdmaExclusion	1	0..*	

**6.6.4.14 UpstreamPhysicalChannel**

This configuration object is included in Figure 6-4 for reference. It is defined in Section 6.6.6.8.6, UpstreamPhysicalChannel.

**6.6.4.15 EnetPort**

The EnetPort object is an abstract class that allows an Ethernet port to be configured on a line card that contains Ethernet ports. EnetPort is also a type of the abstract class Port. Ethernet ports are associated with the SreLineCard and the EponLineCard.

**Table 6-20 - EnetPort Object Associations**

Associated Object Name	Type	Near-end Multiplicity	Far-end Multiplicity	Label
Port	Specialization of Port			
IpInterface	Directed composition to IpInterface		0..1	
IpAcl	Directed association to IpAcl		0..1	Ingress
IpAcl	Directed association to IpAcl		0..1	Egress

**6.6.4.16 OneGigEthernet**

This object configures a one-gigabit interface for an Ethernet port. The speed and duplex settings for this type of port can be configured via this object.

**Table 6-21 - OneGigEthernet Object Attributes**

Attribute Name	Type	Required Attribute	Type Constraints	Units	Default Value
Duplex	Enum	No	other(1), fullDuplex(2), halfDuplex(3), autoNegotiated(4)		fullDuplex
Speed	Enum	Yes	other(1), tenMbitEthernet(2), hundredMbitEthernet(3), oneGigabit(4), auto(5)		

**Table 6-22 - OneGigEthernet Object Associations**

Associated Object Name	Type	Near-end Multiplicity	Far-end Multiplicity	Label
EnetPort	Specialization of EnetPort			



#### 6.6.4.16.1 OneGigEthernet Object Attributes

##### 6.6.4.16.1.1 Duplex

This attribute configures the Ethernet DuplexState of the interface. The value of other(1) is used when a vendor-extension has been implemented for this attribute.

##### 6.6.4.16.1.2 Speed

This attribute configures the speed of the interface for interfaces that can support multiple speeds. The value of other(1) is used when a vendor-extension has been implemented for this attribute.

#### 6.6.4.17 TenGigEthernet

This object configures a ten-gigabit interface for an Ethernet port.

**Table 6-23 - TenGigEthernet Object Associations**

Associated Object Name	Type	Near-end Multiplicity	Far-end Multiplicity	Label
EnetPort	Specialization of EnetPort			

#### 6.6.4.18 FortyGigEthernet

This object configures a 40-gigabit interface for an Ethernet port.

**Table 6-24 - FortyGigEthernet Object Associations**

Associated Object Name	Type	Near-end Multiplicity	Far-end Multiplicity	Label
EnetPort	Specialization of EnetPort			

#### 6.6.4.19 OneHundredGigEthernet

This object configures a 100-gigabit interface for an Ethernet port.

**Table 6-25 - OneHundredGigEthernet Object Associations**

Associated Object Name	Type	Near-end Multiplicity	Far-end Multiplicity	Label
EnetPort	Specialization of EnetPort			

#### 6.6.4.20 PonPort

This abstract configuration object allows for an EPON port to be configured on an EPON line card. PonPort is a type of the abstract class Port.

**Table 6-26 - PonPort Object Associations**

Associated Object Name	Type	Near-end Multiplicity	Far-end Multiplicity	Label
Port	Specialization of Port			

**6.6.4.21 OneGigEpon**

This configuration object allows for a one Gigabit EPON port to be configured on an EPON line card. It is a type of the abstract class PonPort.

**Table 6-27 - OneGigEpon Object Attributes**

Attribute Name	Type	Required Attribute	Type Constraints	Units	Default Value
UpstreamFecMode	Enum	No	other(1), enabled(2), disabled(3), perOnu(4)		disabled
DownstreamFecMode	Enum	No	other(1), enabled(2), disabled(3), perOnu(4)		disabled

**Table 6-28 - OneGigEpon Object Associations**

Associated Object Name	Type	Near-end Multiplicity	Far-end Multiplicity	Label
PonPort	Specialization of PonPort			

**6.6.4.21.1 OneGigEpon Object Attributes**

**6.6.4.21.1.1 UpstreamFecMode**

This attribute configures the FEC mode applied to the EPON upstream. The perOnu option allows the ONU provisioning process to determine whether FEC should be enabled or disabled. This option is only valid for 1G EPON interfaces.

The default value for the 1G EPON interface is disabled(3).

The value of other(1) is used when a vendor-extension has been implemented for this attribute.

**6.6.4.21.1.2 DownstreamFecMode**

This attribute configures the FEC mode of the EPON downstream. The perOnu option allows the ONU provisioning process to determine whether FEC should be enabled or disabled. This option is only valid for 1G EPON interfaces.

The default value for the 1G EPON interface is disabled(3).

The value of other(1) is used when a vendor-extension has been implemented for this attribute.

**6.6.4.22 TenGigEpon**

This configuration object allows for a symmetric or asymmetric ten Gigabit EPON port to be configured on an EPON line card. It is a type of the abstract class PonPort.

**Table 6-29 - TenGigEpon Object Attributes**

Attribute Name	Type	Required Attribute	Type Constraints	Units	Default Value
PonType	Enum	Yes	other(1), symmetric10x10(2), asymmetric10x1(3)		
UpstreamFecMode	Enum	No	other(1), enabled(2), disabled(3), perOnu(4)		See description

Attribute Name	Type	Required Attribute	Type Constraints	Units	Default Value
DownstreamFecMode	Enum	No	other(1), enabled(2), disabled(3), perOnu(4)		See description

**Table 6-30 - TenGigEpon Object Associations**

Associated Object Name	Type	Near-end Multiplicity	Far-end Multiplicity	Label
PonPort	Specialization of PonPort			

#### 6.6.4.22.1 TenGigEpon Object Attributes

##### 6.6.4.22.1.1 PonType

This attribute configures the speed of the 10G EPON interfaces on the line card and allows for asymmetrical upstream and downstream speeds. The value of other(1) is used when a vendor-extension has been implemented for this attribute.

##### 6.6.4.22.1.2 UpstreamFecMode

This attribute configures the FEC mode applied to the EPON upstream. The perOnu option allows the ONU provisioning process to determine whether FEC should be enabled or disabled. This option is only valid for 1G EPON interfaces.

The default value for the 1G EPON interface is disabled(3).

The default value for the 10G EPON interface is enabled(2).

The value of other(1) is used when a vendor-extension has been implemented for this attribute.

##### 6.6.4.22.1.3 DownstreamFecMode

This attribute configures the FEC mode of the EPON downstream. The perOnu option allows the ONU provisioning process to determine whether FEC should be enabled or disabled. This option is only valid for 1G EPON interfaces.

The default value for the 1G EPON interface is disabled(3).

The default value for the 10G EPON interface is enabled(2).

The value of other(1) is used when a vendor-extension has been implemented for this attribute.

### 6.6.5 CCAP Video Session Configuration Objects

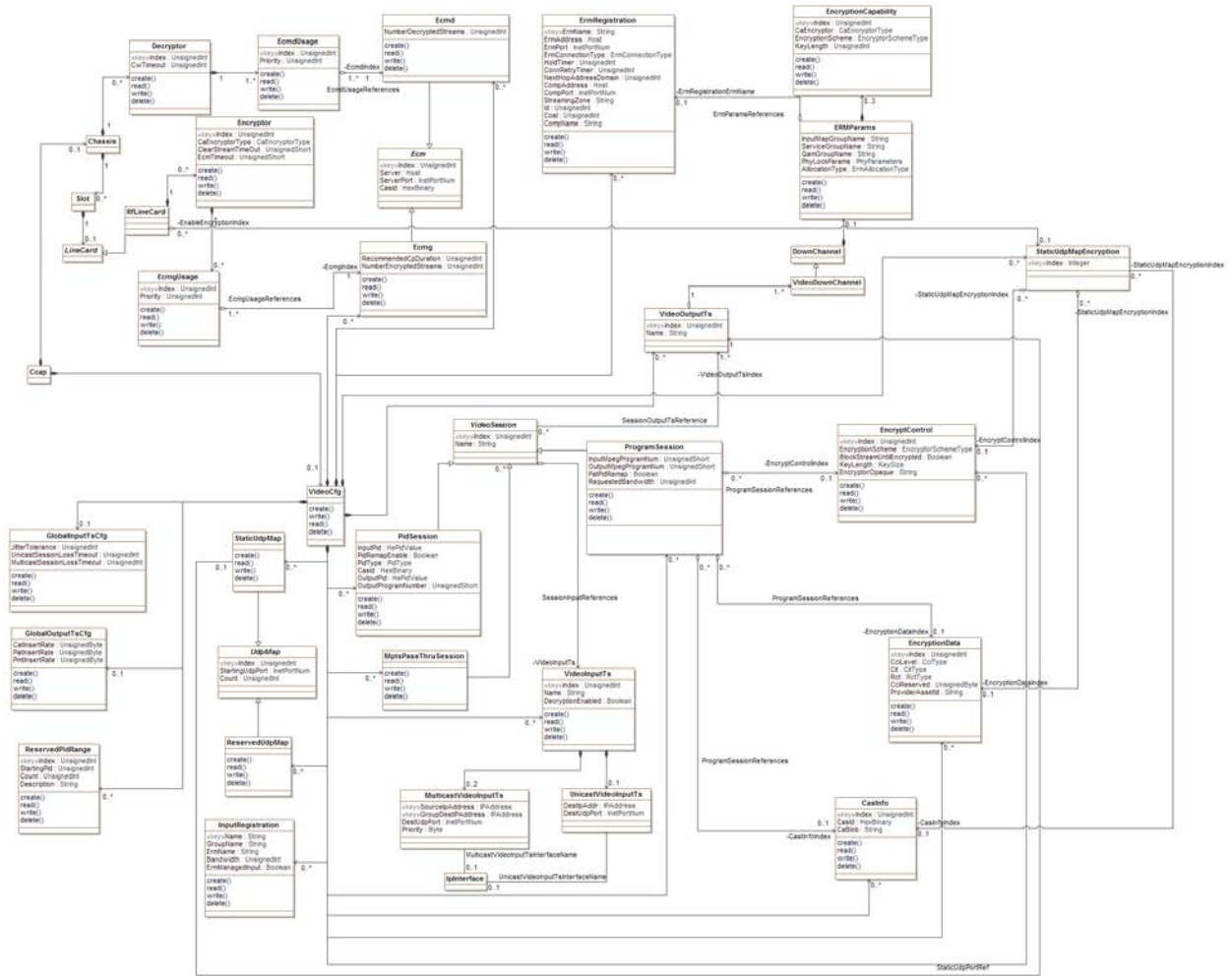

Figure 6-5 - CCAP Video Session Configuration Objects<sup>17</sup>

#### 6.6.5.1 Ccap

This configuration object is included in Figure 6-5 for reference. It is defined in Section 6.6.3.1, Ccap Object.

#### 6.6.5.2 VideoCfg

The VideoCfg object is the primary container of video configuration objects. It has the following associations:

Table 6-31 - VideoCfg Object Associations

Associated Object Name	Type	Near-end Multiplicity	Far-end Multiplicity	Label
GlobalInputTsCfg	Directed composition to GlobalInputTsCfg		0..1	
GlobalOutputTsCfg	Directed composition to GlobalOutputTsCfg		0..1	
StaticUdpMap	Directed composition to StaticUdpMap		0..*	
ReservedUdpMap	Directed composition to ReservedUdpMap		0..*	

<sup>17</sup> Modified per CCAP-OSSlv3.1-N-15.1349-3 on 8/13/15 by KB.

Associated Object Name	Type	Near-end Multiplicity	Far-end Multiplicity	Label
ReservedPidRange	Directed composition to ReservedPidRange		0..*	
InputRegistration	Directed composition to InputRegistration		0..*	
ProgramSession	Directed composition to ProgramSession		0..*	
MptsPassThruSession	Directed composition to MptsPassThruSession		0..*	
PidSession	Directed composition to PidSession		0..*	
VideoInputTs	Directed composition to VideoInputTs		0..*	
CasInfo	Directed composition to CasInfo		0..*	
EncryptionData	Directed composition to EncryptionData		0..*	
EncryptControl	Directed composition to EncryptControl		0..*	
ErmRegistration	Directed composition to ErmRegistration		0..*	
VideoOutputTs	Directed composition to VideoOutputTs		0..*	
Ecmg	Directed composition to Ecmg		0..*	
Ecnd	Directed composition to Ecnd		0..*	
StaticUdpMapEncryption	Directed composition to StaticUdpMapEncryption		0..*	

### 6.6.5.3 GlobalInputTsCfg

This object represents global configuration of input transport streams.

**Table 6-32 - GlobalInputTsCfg Object Attributes**

Attribute Name	Type	Required Attribute	Type Constraints	Units	Default Value
JitterTolerance	UnsignedInt	No		milliseconds	100
UnicastSessionLossTimeout	UnsignedInt	No		milliseconds	5000
MulticastSessionLossTimeout	UnsignedInt	No		milliseconds	5000

#### 6.6.5.3.1 GlobalInputTsCfg Object Attributes

##### 6.6.5.3.1.1 JitterTolerance

This attribute represents the acceptable delay variation in milliseconds for incoming streams. The jitter option sets the size of a dejittering buffer that absorbs the input jitter of a session.

##### 6.6.5.3.1.2 UnicastSessionLossTimeout

This attribute represents the loss of signal timeout in milliseconds for unicast input streams. See [SCTE 154-4], mpegLossOfSignalTimeout.

##### 6.6.5.3.1.3 MulticastSessionLossTimeout

This attribute represents the loss of signal timeout in milliseconds for the multicast input streams.

### 6.6.5.4 GlobalOutputTsCfg

This object represents global configuration of output transport streams.

**Table 6-33 - GlobalOutputTsCfg Object Attributes**

Attribute Name	Type	Required Attribute	Type Constraints	Units	Default Value
CatInsertRate	UnsignedByte	No	0..32	tables/second	10
PatInsertRate	UnsignedByte	No	0..32	tables/second	10
PmtInsertRate	UnsignedByte	No	0..32	tables/second	10

6.6.5.4.1 *GlobalOutputTsCfg Object Attributes*

6.6.5.4.1.1 *CatInsertRate*

This attribute represents the CAT insertion rate expressed in tables/second (see [SCTE 154-4], mpegOutputTSCatInsertRate).

6.6.5.4.1.2 *PatInsertRate*

This attribute represents the PAT table interval expressed in tables/second (see [SCTE 154-4], mpegOutputTSPatInsertRate).

6.6.5.4.1.3 *PmtInsertRate*

This attribute represents the PMT table interval expressed in tables/second (see [SCTE 154-4], mpegOutputTSPatInsertRate).

**6.6.5.5 *UdpMap***

This abstract object holds the UDP attributes that are used in the StaticUdpMap and ReservedUdpMap objects.

**Table 6-34 - UdpMap Object Attributes**

Attribute Name	Type	Required Attribute	Type Constraints	Units	Default Value
Index	UnsignedInt	Yes (Key)			
StartingUdpPort	InetPortNum	No			0
Count	UnsignedInt	No			0

6.6.5.5.1 *UdpMap Object Attributes*

6.6.5.5.1.1 *Index*

This key represents a globally unique identifier of the object instance.

6.6.5.5.1.2 *StartingUdpPort*

This attribute represents the UDP port range start value.

6.6.5.5.1.3 *Count*

This attribute represents the number of UDP ports starting from the StartingPort attribute value.

**6.6.5.6 *StaticUdpMap***

This object represents the UDP port ranges used for static video sessions. It is a specialization of UdpMap.

**Table 6-35 - StaticUdpMap Object Associations**

Associated Object Name	Type	Near-end Multiplicity	Far-end Multiplicity	Label
UdpMap	Specialization of UdpMap			
VideoOutputTs	Directed association to VideoOutputTs	0..1	1	StaticUdpPortRef

**6.6.5.7 *ReservedUdpMap***

This object represents reserved ports to be used for non-video applications. It is a specialization of UdpMap.

**Table 6-36 - ReservedUdpMap Object Associations**

Associated Object Name	Type	Near-end Multiplicity	Far-end Multiplicity	Label
UdpMap	Specialization of UdpMap			

### 6.6.5.8 ReservedPidRange

This object represents reserved PID range to not be used on ERM assignments.

**Table 6-37 - ReservedPidRange Object Attributes**

Attribute Name	Type	Required Attribute	Type Constraints	Units	Default Value
Index	UnsignedInt	Yes (Key)			
StartingPid	UnsignedInt	No			0
Count	UnsignedInt	No			0
Description	String	No			""

#### 6.6.5.8.1 ReservedPidRange Object Attributes

##### 6.6.5.8.1.1 Index

This key represents the unique identifier of an instance of this object.

##### 6.6.5.8.1.2 StartingPid

This attribute represents the PID range starts for other applications' reserved PIDs.

##### 6.6.5.8.1.3 Count

This attribute represents the number of reserved PIDs starting from the StartingPid attribute value.

##### 6.6.5.8.1.4 Description

This attribute represents the description associated with a PID range configured instance.

### 6.6.5.9 InputRegistration<sup>18</sup>

This object configures which input interfaces are advertised to the ERM and whether a given advertised interface has its capacity managed by the ERM or the CCAP.

**Table 6-38 - InputRegistration Object Attributes**

Attribute Name	Type	Required Attribute	Type Constraints	Units	Default Value
Name	String	Yes (Key)			
GroupName	String	No			""
ErmName	String	Yes			
Bandwidth	UnsignedInt	No			0
ErmManagedInput	Boolean	Yes			

<sup>18</sup> Section, table, and subsections modified per CCAP-OSSiv3.1-N-15.1349-3 on 8/13/15 by KB.

6.6.5.9.1 *InputRegistration Object Attributes*

6.6.5.9.1.1 Name

This key represents the Input interface name. This name corresponds to the [RFC 4133], ENTITY-MIB entPhysicalName.

6.6.5.9.1.2 GroupName

This attribute represents the name of the Edge Input Group associated with this input. This parameter is reported to the ERM via the RMI-SDR interface in the Edge Device Configuration message and in the ERRP Edge Input attribute.

6.6.5.9.1.3 ErmName

This attribute represents the ERM where the input interface is advertised.

6.6.5.9.1.4 Bandwidth

This attribute represents the bandwidth of the edge input to be advertised. If zero or not present, the CCAP advertises the full bandwidth of the edge input. If the attribute ErmManagedInput is set to false, operators should set this attribute to a value that greatly exceeds the speed of the input interface; this will cause the ERM to not actively manage the input bandwidth.

6.6.5.9.1.5 ErmManagedInput

This attribute allows the Operator to configure whether or not the ERM should manage the input bandwidth on this EdgeInput Interface. A value of true indicates that the ERM will manage the input bandwidth; a value of false indicates that the CCAP will manage the input bandwidth. If set to false, operators should set the Bandwidth attribute to a value that greatly exceeds the speed of the input interface so that the ERM will not actively manage the input bandwidth.

**6.6.5.10 CasInfo**

The CasInfo object serves two purposes:

1. It identifies the ECMG(s) that need(s) to be involved in the encryption of the program session. In the case of a Simulcrypt operation, more than one CasInfo object can be attached to the same ProgramSession.
2. It defines a CA-specific opaque object that needs to be forwarded to the appropriate ECMG when the session is initialized.

A CasInfo object contains the attributes in the following table.

**Table 6-39 - CasInfo Object Attributes**

Attribute Name	Type	Required Attribute	Type Constraints	Units	Default Value
Index	UnsignedInt	Yes (Key)			
CasId	HexBinary	Yes	size(8)		
CaBlob	String	Yes			

6.6.5.10.1 *CasInfo Object Attributes*

6.6.5.10.1.1 Index

This attribute configures the index for an instance of CasInfo for a given ProgramSession.



### 6.6.5.10.1.2 CasId

CasId is the hexadecimal representation of the CAS system identifier.

### 6.6.5.10.1.3 CaBlob

CaBlob is opaque data that the Encryptor is required to forward to the ECMG associated with the specified CasId.

## 6.6.5.11 EncryptionData

The EncryptionData object allows a per video session encryption configuration.

**Table 6-40 - EncryptionData Object Attributes**

Attribute Name	Type	Required Attribute	Type Constraints	Units	Default Value
Index	UnsignedInt	Yes (Key)			
CciLevel	Enum	Yes	other(1), copyFreely(2), copyOneGeneration(3), copyNoMore(4), copyNever(5)		
Cit	Enum	Yes	other(1), clear(2), set(3)		
Rct	Enum	Yes	other(1), notAsserted(2), required(3)		
CciReserved	UnsignedByte	Yes	0..3		
ProviderAssetId	String	Yes	1..255		

### 6.6.5.11.1 EncryptionData Object Attributes

#### 6.6.5.11.1.1 Index

The index is the key for the EncryptionData object.

#### 6.6.5.11.1.2 CciLevel

This attribute represents the Copy Control Indicator/Digital Rights protection applicable to the program. It is forwarded to all active ECMGs to be encapsulated into ECMs. The value of other(1) is used when a vendor-extension has been implemented for this attribute.

#### 6.6.5.11.1.3 Cit

This attribute represents the Constrained Image Trigger flag applicable to the program. It is forwarded to all active ECMGs to be encapsulated into ECMs. The value of other(1) is used when a vendor-extension has been implemented for this attribute.

#### 6.6.5.11.1.4 Rct

This attribute represents the Redistribution Control Trigger flag applicable to the program. It is forwarded to all active ECMGs to be encapsulated into ECMs. The value of other(1) is used when a vendor-extension has been implemented for this attribute.

#### 6.6.5.11.1.5 CciReserved

This attribute reserves 2 bits of copy control information (CCI) for future use. It is forwarded to all active ECMGs to be encapsulated into ECMs.

#### 6.6.5.11.1.6 ProviderAssetId

This attribute configures the Provide Asset Id parameter that is passed in the initial RTSP session SETUP (e.g., for VOD) to the Encryptor and enables the Encryptor to uniquely identify/reference the VOD asset or broadcast channel.

#### 6.6.5.12 *EncryptControl*

This configuration object selects the encryption option of a static encryption session.

**Table 6-41 - *EncryptControl* Object Attributes**

Attribute Name	Type	Required Attribute	Type Constraints	Units	Default Value
Index	UnsignedInt	Yes (Key)			
EncryptionScheme	Enum	Yes	other(1), des(2), aes(3), 3des(4), dvbcsa(5), dvbcsa3(6)		
BlockStreamUntilEncrypted	Boolean	No			true
KeyLength	Enum	Yes	other(1), 56bits(2), 128bits(3), 192bits(4), 256bits(5)		
EncryptorOpaque	String	Yes			

#### 6.6.5.12.1 *EncryptControl* Object Attributes

##### 6.6.5.12.1.1 Index

This attribute configures the index for an instance of *EncryptControl* for a given *ProgramSession*.

##### 6.6.5.12.1.2 EncryptionScheme

This attribute defines the encryption algorithm to be used for a given video session. The value of other(1) is used when a vendor-extension has been implemented for this attribute.

##### 6.6.5.12.1.3 BlockStreamUntilEncrypted

*BlockStreamUntilEncrypted* indicates if the encryption engine should block the program until it can encrypt it (i.e., it has received a first Entitlement Control Message (ECM) and Control Word (CW) from the ECMG) or release it in the clear to the destination or output. Values are 0 meaning false or 1 meaning true. Note that this parameter can be used to enforce synchronous behavior, wherein the RTSP server (i.e., Encryption Engine) will not acknowledge the session request back to the ERM until it has actually started to encrypt the stream. Obviously, this assurance comes at the expense of setup latency.

##### 6.6.5.12.1.4 KeyLength

This attribute configures the number of bits in the encryption keys used by encryption algorithm defined by the *EncryptionScheme* attribute. The value of other(1) is used when a vendor-extension has been implemented for this attribute.

##### 6.6.5.12.1.5 EncryptorOpaque

*EncryptorOpaque* holds private data used by the Encryptor that may be under CA license from the CA vendor.

### 6.6.5.13 VideoInputTs

The VideoInputTs object configures a given MPEG-2 Transport stream that may be unicast or multicast. Each VideoInputTs object MUST have either:

- one or two MulticastVideoInputTs objects associated with it,
- one UnicastVideoInputTs object associated with it.

Having two MulticastVideoInputTs objects associated with it occurs when input TS redundancy is configured (Hot-Hot sparing).

**Table 6-42 - VideoInputTs Object Attributes**

Attribute Name	Type	Required Attribute	Type Constraints	Units	Default Value
Index	UnsignedInt	Yes (Key)			
Name	String	No			""
DecryptionEnabled	Boolean	No			false

When redundancy of the input multicast TS is configured, a VideoInputTs object is associated with two MulticastVideoInputTs objects. A VideoInputTs object can also be referenced from multiple ProgramSession, MptsPassThruSession, or PidSession objects.

**Table 6-43 - VideoInputTs Object Associations**

Associated Object Name	Type	Near-end Multiplicity	Far-end Multiplicity	Label
MulticastVideoInputTs	Directed composition to MulticastVideoInputTs		0..2	
UnicastVideoInputTs	Directed composition to UnicastVideoInputTs		0..1	

#### 6.6.5.13.1 VideoInputTs Attributes

##### 6.6.5.13.1.1 Index

This is the index for an instance of the VideoInputTs object.

##### 6.6.5.13.1.2 Name

This is a unique name for this instance of the VideoInputTs object.

##### 6.6.5.13.1.3 DecryptionEnabled

This attribute configures whether this input stream is encrypted for transport across the WAN. This WAN encryption is intended to be removed at the CCAP and not related to any CA encryption that may be configured for the output stream. A value of true means that the CCAP needs to decrypt this input stream as applicable. A value of false means that the CCAP does not need to decrypt this input stream. Default value is false.

### 6.6.5.14 UnicastVideoInputTs

This object specifies the unicast flow of an input transport stream.

**Table 6-44 - UnicastVideoInputTs Object Attributes**

Attribute Name	Type	Required Attribute	Type Constraints	Units	Default Value
DestIpAddr	IpAddress	See attribute description			
DestUdpPort	InetPortNum	Yes			

A UnicastVideoInputTs object may be associated with a specific IpInterface. In this case, the DestIpAddr is not required. If an association is made to a UnicastVideoInputTsInterfaceName, care needs to be taken to make sure that the DestUdpPort specified does not overlap with the UDP port used for other traffic that may be present on the associated IpInterface instance.

**Table 6-45 - UnicastVideoInputTs Object Associations**

Associated Object Name	Type	Near-end Multiplicity	Far-end Multiplicity	Label
IpInterface	Association to IpInterface		0..1	UnicastVideoInputTsInterfaceName

#### 6.6.5.14.1 UnicastVideoInputTs Object Attributes

##### 6.6.5.14.1.1 DestIpAddr

This attribute corresponds to the IP destination address of the UDP IP flow of the input TS. This attribute is required unless the UnicastVideoInputTs object is associated with an IpInterface instance. If the IP address specified in the DestIpAddr attribute does not exist on the CCAP, the CCAP MUST reject this configuration.

When the value of the DestIpAddr attribute is set to all zeros (e.g., 0.0.0.0), the CCAP MUST listen for the traffic on the specified UDP port number on all IP interfaces.

##### 6.6.5.14.1.2 DestUdpPort

This attribute corresponds to the UDP destination port of the UDP IP flow of the input TS.

#### 6.6.5.15 MulticastVideoInputTs

This object specifies the multicast flows of an input transport stream. Having two MulticastVideoInputTs objects for one VideoInputTs occurs when input TS redundancy is configured (Hot-Hot sparing). If two MulticastVideoInputTs objects have the same Priority, this implies HOT-HOT redundancy. Which stream is actually forwarded is vendor-specific.

**Table 6-46 - MulticastVideoInputTs Object Attributes**

Attribute Name	Type	Required Attribute	Type Constraints	Units	Default Value
SourceIpAddress	IpAddress	Yes (Key)			
GroupDestIpAddress	IpAddress	Yes (Key)			
DestUdpPort	InetPortNum	No			0
Priority	Byte	Yes			

A MulticastVideoInputTs object may be associated with a specific IpInterface. This associations provides a static mapping of the source of an input transport stream to an IP interface.

**Table 6-47 - MulticastVideoInputTs Object Associations**

Associated Object Name	Type	Near-end Multiplicity	Far-end Multiplicity	Label
IpInterface	Association to IpInterface		0..1	MulticastVideoInputTsInterfaceName

#### 6.6.5.15.1 MulticastVideoInputTs Object Attributes

##### 6.6.5.15.1.1 SourceIpAddress

This attribute corresponds to the Source Specific Multicast IP Address of the UDP IP flow.

#### 6.6.5.15.1.2 GroupDestIpAddress

This attribute corresponds to the group address of a SSM (Source Specific Multicast) origination input TS.

#### 6.6.5.15.1.3 DestUdpPort

This attribute corresponds to the UDP destination port of the UDP IP flow of the input TS.

#### 6.6.5.15.1.4 Priority

This attribute is a number that identifies the preference order of this transport stream; higher number indicates a higher priority. It is used to order the multicast transport stream for the purpose of redundancy in the case of multiple multicast video sources. If two entries have the same "Priority", it implies Hot-Hot redundancy.

### 6.6.5.16 VideoOutputTs<sup>19</sup>

The VideoOutputTs object represents a configuration multiplex of one or more ProgramSession, PidSession, or MptsPassThruSession instances. In cases where a VideoDownChannel is dynamically managed by an ERM, the VideoOutputTs may not be associated with any video program sessions.

**Table 6-48 - VideoOutputTs Object Attributes**

Attribute Name	Type	Required Attribute	Type Constraints	Units	Default
Index	UnsignedInt	Yes (Key)			
Name	String	No			""

**Table 6-49 - VideoOutputTs Object Associations**

Associated Object Name	Type	Near-end Multiplicity	Far-end Multiplicity	Label
VideoDownChannel	Directed aggregation to VideoDownChannel	1	1..*	

#### 6.6.5.16.1 VideoOutputTs Object Attributes

##### 6.6.5.16.1.1 Index

This is an index for an instance of this Object. It uniquely identifies a CCAP-generated MPTS composed of one or more program streams, PID streams and/or pass thru MPTS. This is NOT the Output TSID used for replication.

##### 6.6.5.16.1.2 Name

This attribute configures the name of this instance of VideoOutputTs.

### 6.6.5.17 VideoDownChannel

This configuration object is included in Figure 6-5 for reference. It is defined in Section 6.6.6.9.3, VideoDownChannel.

### 6.6.5.18 DownChannel

This configuration object is included in Figure 6-5 for reference. It is defined in Section 6.6.6.9.1, DownChannel.

<sup>19</sup> Modified per CCAP-OSSiv3.1-N-15.1349-3 on 8/13/15 by KB.

**6.6.5.19 ErmParams<sup>20</sup>**

This configuration object allows for the configuration of the needed parameters that are communicated to an ERM for a given DownChannel object instance. If a DownChannel instance is managed by an ERM, it will contain ERM parameters.

**Table 6-50 - ErmParams Object Attributes**

Attribute Name	Type	Required Attribute	Type Constraints	Units	Default Value
InputMapGroupName	String	No			""
ServiceGroupName	String	No			""
QamGroupName	String	No			""
PhyLockParams	EnumBits	No	frequency(0), bandwidth(1), power(2), modulation(3), interleaver(4), j83Annex(5), symbolRate(6), mute(7)		"H"
AllocationType	EnumBits	Yes	linear(0), vod(1) sdv(2) docsis(3)		

**Table 6-51 - ErmParams Object Associations**

Associated Object Name	Type	Near-end Multiplicity	Far-end Multiplicity	Label
EncryptionCapability	Directed composition to EncryptionCapability		0..3	
ErmRegistration	Directed aggregation to ErmRegistration		0..1	ErmRegistrationErmName

**6.6.5.19.1 ErmParams Object Attributes**

**6.6.5.19.1.1 InputMapGroupName**

This attribute indicates which input interfaces reach this channel output. Instances of the InputRegistration object assign an input group name to input interfaces. If NSI ports and RF ports have any-to-any connectivity, this attribute can be excluded.

For ERMI implementations, this represents the address field in the WithdrawnRoute and ReachableRoutes ERRP attributes. This attribute is optional for DocsisDownChannel.

**6.6.5.19.1.2 ServiceGroupName**

This attribute specifies the assigned service group for this down channel.

**6.6.5.19.1.3 QamGroupName**

This attribute specifies a name associated with the down channels that are collectively output on the same RF output interface on the CCAP.

**6.6.5.19.1.4 PhyLockParams**

This attribute represents the PHY parameters Lock state of the QAM channels for DEPI-initiated PHY parameters updates.

<sup>20</sup> This section and subsections modified per CCAP-OSSv3.1-N-15.1349-3 on 8/13/15 by KB.

### 6.6.5.19.1.5 AllocationType

This attribute defines for the ERM which services this specific DownChannel instance can support.

### 6.6.5.20 EncryptionCapability

The EncryptionCapability object defines one encryption option of the Encryptor that needs to be reported to the ERM. There can be up to three EncryptionCapability objects per QAM. In return, the ERM is expected to create dynamic sessions using one of the reported encryption options.

**Table 6-52 - EncryptionCapability Object Attributes**

Attribute Name	Type	Required Attribute	Type Constraints	Units	Default Value
Index	UnsignedInt	Yes (Key)			
CaEncryptor	Enum	Yes	other(1), motorola(2), cisco(3), simulcrypt(4)		
EncryptionScheme	Enum	Yes	other(1), des(2), aes(3), 3des(4), dvbcsa(5), dvbcsa3(6)		
KeyLength	UnsignedInt	Yes			

#### 6.6.5.20.1 EncryptionCapability Object Attributes

##### 6.6.5.20.1.1 Index

This attribute assigns a unique identifier to this instance of the EncryptionCapability object.

##### 6.6.5.20.1.2 CaEncryptor

This enumeration defines the type of CA encryption the Encryptor uses. The value of other(1) is used when a vendor-extension has been implemented for this attribute.

##### 6.6.5.20.1.3 EncryptionScheme

This attribute defines the encryption algorithms applicable to the CA encryption defined by the CaEncryptor attribute. The value of other(1) is used when a vendor-extension has been implemented for this attribute.

##### 6.6.5.20.1.4 KeyLength

This attribute defines the key length applicable to the algorithm defined by the EncryptionScheme attribute.

### 6.6.5.21 ErmRegistration

This object allows for the configuration of the interface to an Edge Resource Manager. Generally, one configured ERM interface exists for the entire CCAP. An ErmRegistration object contains the attributes in the following table. The CCAP MAY support only one instance of the ErmRegistration object. Configuring more than one ERM is generally used for scaling purposes, with each individual ERM being focused on specific, unique service groups. More than one ERM cannot be practically used to support the same service group, and there could be conflicts between the control messages of the independent ERMs.

The optional attributes in this object are provided for backwards compatibility with ERMI.

**Table 6-53 - ErmRegistration Object Attributes<sup>21</sup>**

Attribute Name	Type	Required Attribute	Type Constraints	Units	Default Value
ErmName	String	Yes (Key)			
ErmAddress	Host	Yes			
ErmPort	InetPortNum	No			0
ErmConnectionType	Enum	No	other(1), client(2), server(3), clientAndServer(4)		client
HoldTimer	UnsignedInt	No	0   3.. 3600	seconds	240
ConnRetryTimer	UnsignedInt	No		seconds	20
NextHopAddressDomain	UnsignedInt	No			""
CompAddress	Host	No			"
CompPort	InetPortNum	No			6069
StreamingZone	String	Yes	1..255		
Id	UnsignedInt	No			0
Cost	UnsignedInt	No			0
CompName	String	No	1..255		""

#### 6.6.5.21.1 ErmRegistration Object Attributes

##### 6.6.5.21.1.1 ErmName

This key represents the name of the ERM related to this registration instance. This is an internal reference for associating, e.g., QAM channels and input interfaces to an ERM.

##### 6.6.5.21.1.2 ErmAddress

This attribute represents the IP Address or FQDN of the ERM.

##### 6.6.5.21.1.3 ErmPort

This attribute represents the TCP port number used to reach the ERM.

##### 6.6.5.21.1.4 ErmConnectionType

This attribute represents the type of TCP connection that is established by the CCAP. The value can be one of the following:

- other(1) indicates that a vendor-extension has been implemented for this attribute.
- client(2) indicates that the CCAP has to initiate the TCP connection with the ERM.
- server(3) indicates that the CCAP has to wait for the TCP connection from the ERM.
- clientAndServer(4) indicates that either the CCAP or the ERM can initiate the TCP connection.

##### 6.6.5.21.1.5 HoldTimer

This attribute represents the number of seconds that the sender proposes for the value of the hold timer. Upon receipt of an OPEN message, the CCAP MUST calculate the value of the Hold Timer by using the smaller of its configured Hold Time and the Hold Time received in the OPEN message.

The Hold Time has to be either zero or at least three seconds.

<sup>21</sup> Table modified per CCAP-OSSv3.1-N-15.1349-3 on 8/13/15 by KB.



The CCAP MAY reject connections on the basis of the Hold Time. The calculated value indicates the maximum number of seconds that may elapse between the receipt of successive KEEPALIVE and/or UPDATE messages by the sender.

#### 6.6.5.21.1.6 ConnRetryTimer

This attribute represents the time in seconds for the connect retry timer. The exact value of the connect retry timer is a local matter, but should be sufficiently large to allow TCP initialization.

#### 6.6.5.21.1.7 NextHopAddressDomain

This attribute represents the address domain number of the next-hop server. The NextHopServer specifies the address to which a manager should use to connect to the component in order to control the resource specified in the reachable route. This parameter is used in the ERRP NextHopServer attribute.

#### 6.6.5.21.1.8 CompAddress

This attribute represents the host portion of the ERRP NextHopServer attribute. This field contains an FQDN, or an IPv4 address using the textual representation defined in section 2.1 of [RFC 1123], or an IPv6 address using the textual representation defined in section 2.2 of [RFC 4291]. This value is sent in the ERRP NextHopServer attribute with the CompPort value in the ERRP messages. The attribute is optional when signaling DOCSIS only resources, however it is defined as a mandatory attribute since the typical use of ErmRegistration is for video.

#### 6.6.5.21.1.9 CompPort

This attribute represents the port portion of the ERRP NextHopServer attribute. This field contains numerical value (1-65535) representing the port number. If the port is empty or not given, the default port 6069 is assumed. This value is sent in the ERRP NextHopServer attribute with the CompAddress value in the ERRP messages. The attribute is optional when signaling DOCSIS only resources, however it is defined as a mandatory attribute since the typical use of ErmRegistration is for video.

#### 6.6.5.21.1.10 StreamingZone

This attribute represents the name of the Streaming Zone within which the component operates. This parameter is used in the ERRP OPEN message. StreamingZone Name is a mandatory parameter when supporting video applications. The capability is optional when signaling DOCSIS only resources.

The value is to be set to the string that represents the StreamingZone Name, i.e., <region>. The characters comprising the string are in the set within TEXT defined in section 15.1 of [RFC 2326]. The CCAP MUST support minimum string lengths of 64 for the StreamingZone attribute of the ErmRegistration object; however, the composition of the string used is defined by implementation agreements specified by the service provider.

A CCAP will exist in a single streaming zone.

#### 6.6.5.21.1.11 Id

This attribute represents the unique identifier for the CCAP device within its Streaming Zone. This value can be set to the 4-octet value of an IPv4 address assigned to that device. This ID value is determined on startup and is the same for all peer connections. This parameter is used in the ERRP OPEN message header.

#### 6.6.5.21.1.12 Cost

This attribute represents the static cost for use of this resource.

#### 6.6.5.21.1.13 CompName

The name of the component for which the data in the update message applies. This parameter is used in the ERRP OPEN message. Component Name is a mandatory parameter when supporting video applications. The capability is optional when signaling DOCSIS only resources.

The value is to be set to the string that represents the Component Name, i.e., <region>.<localname>. The characters comprising the string are in the set within TEXT defined in section 15.1 of [RFC 2326]. The CCAP MUST support minimum string lengths of 64 for the CompName attribute of the ErmRegistration object; however, the composition of the string used is defined by implementation agreements specified by the service provider.

### 6.6.5.22 VideoSession

The VideoSession abstract object holds the common attributes for the session configuration objects (program, PID, and MPTS passthrough).

**Table 6-54 - VideoSession Object Attributes**

Attribute Name	Type	Required Attribute	Type Constraints	Units	Default Value
Index	UnsignedInt	Yes (Key)			
Name	String	No	0..32		""

**Table 6-55 - VideoSession Object Associations**

Associated Object Name	Type	Near-end Multiplicity	Far-end Multiplicity	Label
VideoInputTs	Directed aggregation to VideoInputTs	0..*		VideoInputTs
VideoOutputTs	Association to VideoOutputTS	0..*	1..*	VideoOutputTsIndex

#### 6.6.5.22.1 VideoSession Object Attributes

##### 6.6.5.22.1.1 Index

This is the index for the configured session.

##### 6.6.5.22.1.2 Name

This attribute is the name of the session. Unique names are given to each instance of a session type.

### 6.6.5.23 ProgramSession

The ProgramSession object allows the identification, encryption, processing and insertion of a single program stream into a VideoOutputTs. The CCAP MUST reject configurations with a ProgramSession object which does not have a VideoInputTs object associated with it.

**Table 6-56 - ProgramSession Object Attributes<sup>22</sup>**

Attribute Name	Type	Required Attribute	Type Constraints	Units	Default Value
InputMpegProgramNum	UnsignedShort	Yes			
OutputMpegProgramNum	UnsignedShort	Yes			
PatPidRemap	Boolean	No			true
RequestedBandwidth	UnsignedInt	No		bps	0

To define a ProgramSession object you need to specify either a "unicast" or a "multicast" TSVideoInput object.

<sup>22</sup> Modified per CCAP-OSSv3.1-N-15.1349-3 on 8/13/15 by KB.

**Table 6-57 - ProgramSession Object Associations**

Associated Object Name	Type	Near-end Multiplicity	Far-end Multiplicity	Label
VideoSession	Specialization of VideoSession			
CasInfo	Directed aggregation to CasInfo	0..*	0..1	CasInfoIndex
EncryptionData	Directed aggregation to EncryptionData	0..*	0..1	EncryptionDataIndex
EncryptControl	Directed aggregation to EncryptControl	0..*	0..1	EncryptControlIndex

#### 6.6.5.23.1 ProgramSession Object Attributes

##### 6.6.5.23.1.1 InputMpegProgramNum

This attribute selects a specific program from the transport stream of the incoming video stream. This program number should be part of the incoming PAT. A value of 0 (zero) means that any incoming program number can be accepted.

##### 6.6.5.23.1.2 OutputMpegProgramNum

This attribute specifies the program number to be present in the transport stream of the outgoing video stream. This program number will be part of the outgoing PAT.

##### 6.6.5.23.1.3 PatPidRemap

A value of true indicates that the elementary stream PID of this input program can be remapped to the VideoOutputTs, as long as the PAT and PMT are updated. A value of false indicates that the same input elementary stream PID has to be used on the VideoOutputTs.

##### 6.6.5.23.1.4 RequestedBandwidth

This attribute configures the expected bandwidth parameters for a static input video session described by this object. This parameter is used for encryption and video down channel output resources. A value of 0 (zero) means that no bandwidth validation is required.

#### 6.6.5.24 MptsPassThruSession

The MptsPassThruSession object allows the identification and insertion of an unmodified MPTS into a VideoOutputTs. The CCAP MUST reject configurations that contain a MptsPassThruSession object and do not have a VideoInputTs object associated with it; this association is inherited through the abstract object VideoSession.

To define an MptsPassThruSession object, specify either a "unicast" or a "multicast" VideoInputTs object.

**Table 6-58 - MptsPassThruSession Object Associations**

Associated Object Name	Type	Near-end Multiplicity	Far-end Multiplicity	Label
VideoSession	Specialization of VideoSession			

#### 6.6.5.25 PidSession

The PidSession object allows the identification, processing and insertion of a PID stream into a VideoOutputTs. The CCAP MUST reject configurations that contain a PidSession object and do not have a VideoInputTs object associated with it.

**Table 6-59 - PidSession Object Attributes**

Attribute Name	Type	Required Attribute	Type Constraints	Units	Default Value
InputPid	HePidValue	Yes	0..8191   65535		
PidRemapEnable	Boolean	No			false
PidType	Enum	Yes	other(1), emm(2), nit(3), cat(4), pat(5), fixed(6), eas(7), dsm-cc(8), eiss(9), etvbif(10), video(11), audio(12)		
CasId	HexBinary	No	size(8)		00000000
OutputPid	HePidValue	Yes			
OutputProgramNumber	UnsignedShort	No			

**Table 6-60 - PidSession Object Associations**

Associated Object Name	Type	Near-end Multiplicity	Far-end Multiplicity	Label
VideoSession	Specialization of VideoSession			

**6.6.5.25.1 PidSession Object Attributes**

**6.6.5.25.1.1 InputPid**

This attribute identifies a specific PID stream in the input transport stream.

**6.6.5.25.1.2 PidRemapEnable**

This object configures whether or not the identified PID stream can be remapped when inserted in the VideoOutputTs.

**6.6.5.25.1.3 PidType**

This enumeration defines the type of the identified PID stream. This value is used to understand what anchor table (i.e., PAT, CAT) would need to be updated in case PidRemapEnable is set to True and a remap is required. In case of type "eas", the table sections of the PID stream may need to be interleaved with other table sections that would be present on the same OutputPid. "dsm-cc" is used for digital storage media command and control. "eiss" is used for ETV Integrated Signaling Streams (Stream type 0xC0 or 0x05 w-descriptor tag 0xA2). "etvbif" is used for ETV Binary Interchange Format (Stream type 0xC0 or 0x05 w-descriptor tag 0xA1 OR Stream Type 0X0B). "video" is used for MPEG2 video streams. "audio" is used for MPEG2 audio streams. The value of other(1) is used when a vendor-extension has been implemented for this attribute.

**6.6.5.25.1.4 CasId**

This attribute allows a proper identification of the CAT table parameter(s) that need(s) to be updated when the PidType is set to "EMM", PidRemapEnable is set to True and a remap is required. This parameter is required in Simulcrypt operation when the CAT advertises more than one EMM PID streams. A value of 0 means that no CAS ID is associated with this PID Session.

#### 6.6.5.25.1.5 OutputPid

This attribute defines the expected PID value of the identified PID stream when inserted in the VideoOutputTS. However, the OutputPid value cannot be guaranteed if the PidRemapEnable flag is set to True.

#### 6.6.5.25.1.6 OutputProgramNumber

This attribute defines the output program number for the PID session.

### 6.6.5.26 Chassis

This configuration object is included in Figure 6-5 for reference. It is defined in Section 6.6.4.2, Chassis.

### 6.6.5.27 Decryptor

The Decryptor object provides for the configuration of a Decryptor module or modules in the CCAP that are used to decrypt encrypted content delivered to the CCAP.

**Table 6-61 - Decryptor Object Attributes**

Attribute Name	Type	Required Attribute	Type Constraints	Units	Default Value
Index	UnsignedInt	Yes (Key)			
CwTimeout	UnsignedInt	No		seconds	10

The Decryptor object has the following association.

**Table 6-62 - Decryptor Object Associations**

Associated Object Name	Type	Near-end Multiplicity	Far-end Multiplicity	Label
EcmdUsage	Directed composition to EcmdUsage	1	1..*	

#### 6.6.5.27.1 Decryptor Object Attributes

##### 6.6.5.27.1.1 Index

The Index is an unsigned, 32-bit identifier used as a key for this object.

##### 6.6.5.27.1.2 CwTimeout

This attribute configures the length of time in seconds that the Decryptor should wait for an ECM Decoder (ECMD) before switching to a redundant unit.

### 6.6.5.28 EcmdUsage

The EcmdUsage object provides for the configuration of multiple decryption sessions. It is an intermediate object that provides linkages between Decryptor objects and the ECMD(s) associated with those encrypted streams. The ECMD object is defined in Section 6.6.5.29, Ecmd.

**Table 6-63 - EcmdUsage Object Attributes**

Attribute Name	Type	Required Attribute	Type Constraints	Units	Default Value
Index	UnsignedInt	Yes (Key)			
Priority	UnsignedInt	Yes			

The EcmdUsage object has the following association.

**Table 6-64 - EcmdUsage Object Associations**

Associated Object Name	Type	Near-end Multiplicity	Far-end Multiplicity	Label
Ecmd	Directed aggregation to Ecmd	1..*	1	EcmdIndex

**6.6.5.28.1 EcmdUsage Object Attributes**

**6.6.5.28.1.1 Index**

This is an index for an instance of this Object. The EcmdUsage object is a pointer to the Ecmd object that can be used for any program session that requires decryption as long as the CAS identifier of the input program matches.

**6.6.5.28.1.2 Priority**

This is the configured selection priority for any program session that requires decryption when multiple ECMDs with the same CAS identifier are active. The ECMD with the lowest number should be selected first.

**6.6.5.29 Ecmd**

This object allows for the configuration of the interface to an Entitlement Control Message Decoder (ECMD).

**Table 6-65 - Ecmd Object Attributes**

Attribute Name	Type	Required Attribute	Type Constraints	Units	Default Value
NumberDecryptedStreams	UnsignedInt	Yes			

**Table 6-66 - Ecmd Object Associations**

Associated Object Name	Type	Near-end Multiplicity	Far-end Multiplicity	Label
Ecm	Specialization of Ecm			

**6.6.5.29.1 Ecmd Object Attributes**

**6.6.5.29.1.1 NumberDecryptedStreams**

The maximum number of decrypted streams the ECMD should handle.

**6.6.5.30 Ecm**

This abstract object holds the common attributes of ECMD and ECMG instances.

**Table 6-67 - Ecm Object Attributes**

Attribute Name	Type	Required Attribute	Type Constraints	Units	Default Value
Index	UnsignedInt	Yes (Key)			
Server	Host	Yes			
ServerPort	InetPortNum	Yes			
CasId	HexBinary	Yes	size(8)		

### 6.6.5.30.1 Ecm Object Attributes

#### 6.6.5.30.1.1 Index

The Index is an unsigned, 32-bit identifier used as a key for this object.

#### 6.6.5.30.1.2 Server

This is the IP address or FQDN of the ECMD/ECMG. Encryption code words are sent to this address and ECMs are received from this address.

#### 6.6.5.30.1.3 ServerPort

This is the far-end TCP port for communication.

#### 6.6.5.30.1.4 CasId

This attribute defines the CA System ID that the ECMD/ECMG will use.

### 6.6.5.31 Slot

This configuration object is included in Figure 6-5 for reference. It is defined in Section 6.6.4.4, Slot.

### 6.6.5.32 LineCard

This configuration object is included in Figure 6-5 for reference. It is defined in Section 6.6.4.5, LineCard.

### 6.6.5.33 RfLineCard

This configuration object is included in Figure 6-5 for reference. It is defined in Section 6.6.4.6, RfLineCard.

### 6.6.5.34 Encryptor

This object allows for the configuration of an Encryptor. Each Encryptor object is part of a DLC. Each can be associated with one active and zero or more backup ECMGs. For Simulcrypt, the Encryptor would be associated with multiple active ECMGs, each for a different CAS. An Encryptor object contains the attributes in the following table.

**Table 6-68 - Encryptor Object Attributes**

Attribute Name	Type	Required Attribute	Type Constraints	Units	Default Value
Index	UnsignedInt	Yes (Key)			
CaEncryptorType	Enum	Yes	other(1), motorola(2), cisco(3), simulcrypt(4),		
ClearStreamTimeout	UnsignedShort	No		seconds	10
EcmTimeout	UnsignedShort	No		seconds	10

Encryptor has the following association.

**Table 6-69 - Encryptor Object Associations**

Associated Object Name	Type	Near-end Multiplicity	Far-end Multiplicity	Label
EcmgUsage	Directed composition to EcmgUsage	1	0..*	

6.6.5.34.1 *Encryptor Object Attributes*

6.6.5.34.1.1 Index

This is an index for an instance of this object.

6.6.5.34.1.2 CaEncryptorType

This enumeration defines the type of CA encryption the Encryptor uses. The value of other(1) is used when a vendor-extension has been implemented for this attribute.

6.6.5.34.1.3 ClearStreamTimeout

This configured attribute defines the number of seconds a given stream may be sent in the clear when the stream is configured to be encrypted. If this timer expires and the session has not received any encryption information from the ECMG, the CCAP MUST discontinue forwarding this stream.

6.6.5.34.1.4 EcmTimeout

This attribute configures the number of seconds that a CCAP will wait to get a response from a ECMG before switching to the redundant unit.

**6.6.5.35 EcmgUsage**

The EcmgUsage object provides for the configuration of multiple encryption sessions. It is an intermediate object that provides linkages between Encryptor objects and the ECMG(s) associated with those encrypted streams. The ECMG object is defined in Section 6.6.5.36, Ecmg.

**Table 6-70 - EcmgUsage Object Attributes**

Attribute Name	Type	Required Attribute	Type Constraints	Units	Default Value
Index	UnsignedInt	Yes (Key)			
Priority	UnsignedInt	Yes			

The EcmgUsage object has the following association.

**Table 6-71 - EcmgUsage Object Associations**

Associated Object Name	Type	Near-end Multiplicity	Far-end Multiplicity	Label
Ecmg	Directed aggregation to Ecmg	1..*	1	EcmgIndex

6.6.5.35.1 *EcmgUsage Object Attributes*

6.6.5.35.1.1 Index

This is an index for an instance of this object. It is a pointer to an active Ecmg object that can be used for any program session that requires encryption as long as the CAS identifier matches.

6.6.5.35.1.2 Priority

This is the configured selection priority for any program session that requires encryption when multiple ECMGs with the same CAS identifier are active. The ECMG with the lowest number should be selected first.



### 6.6.5.36 Ecmg

This object allows for the configuration of the interface to an Entitlement Control Message Generator (ECMG). Redundant ECMGs for the same CAS may exist, each with the same CA\_System\_ID, with the priority determining which is currently in use by an Encryptor for a particular CAS. An Ecmg object contains the attributes in the following table.

**Table 6-72 - Ecmg Object Attributes**

Attribute Name	Type	Required Attribute	Type Constraints	Units	Default Value
RecommendedCpDuration	UnsignedInt	Yes	1..*	seconds	
NumberEncryptedStreams	UnsignedInt	Yes		streams	

**Table 6-73 - Ecmg Object Associations**

Associated Object Name	Type	Near-end Multiplicity	Far-end Multiplicity	Label
Ecm	Specialization of Ecm			

#### 6.6.5.36.1 Ecmg Object Attributes

##### 6.6.5.36.1.1 RecommendedCpDuration

The recommended cryptoperiod, in seconds, the ECMG should expect.

##### 6.6.5.36.1.2 NumberEncryptedStreams

The maximum number of encrypted streams the ECMG should handle.

### 6.6.5.37 StaticUdpMapEncryption

This object allows for the configuration of encryption for all static UDP port-mapped sessions on a given downstream RF line card. When this object is associated with an RfLineCard instance, all static UDP port-mapped sessions on that RF Line Card are configured for encryption per the associated encryption objects (the mandatory objects of EncryptControl and CasInfo, and the optional object EncryptionData).

If the StaticUdpMapEncryption object is configured without an association to an instance of EncryptControl or CasInfo, the CCAP MUST reject the configuration instance.

Since this functionality is not used by all operators, implementation of this configuration object in the CCAP is not mandatory; the CCAP MAY exclude this configuration object.

**Table 6-74 - StaticUdpMapEncryption Object Attributes**

Attribute Name	Type	Required Attribute	Type Constraints	Units	Default Value
Index	Integer	Yes			

**Table 6-75 - StaticUdpMapEncryption Object Associations**

Associated Object Name	Type	Near-end Multiplicity	Far-end Multiplicity	Label
EncryptControl	Directed aggregation to EncryptControl	0..*	0..1	EncryptControlIndex
CasInfo	Directed aggregation to CasInfo	0..*	0..1	CasInfoIndex
EncryptionData	Directed aggregation to EncryptionData	0..*	0..1	EncryptionDataIndex

6.6.5.37.1 *StaticUdpMapEncryption Object Attributes*

6.6.5.37.1.1 Index

This attribute configures a unique index for an instance of this object.

6.6.6 DOCSIS Configuration Objects

The objects in the following sections configure DOCSIS on the CCAP. They have been grouped logically for usability.

6.6.6.1 DOCSIS System Configuration

These objects define global DOCSIS configuration for the CCAP.

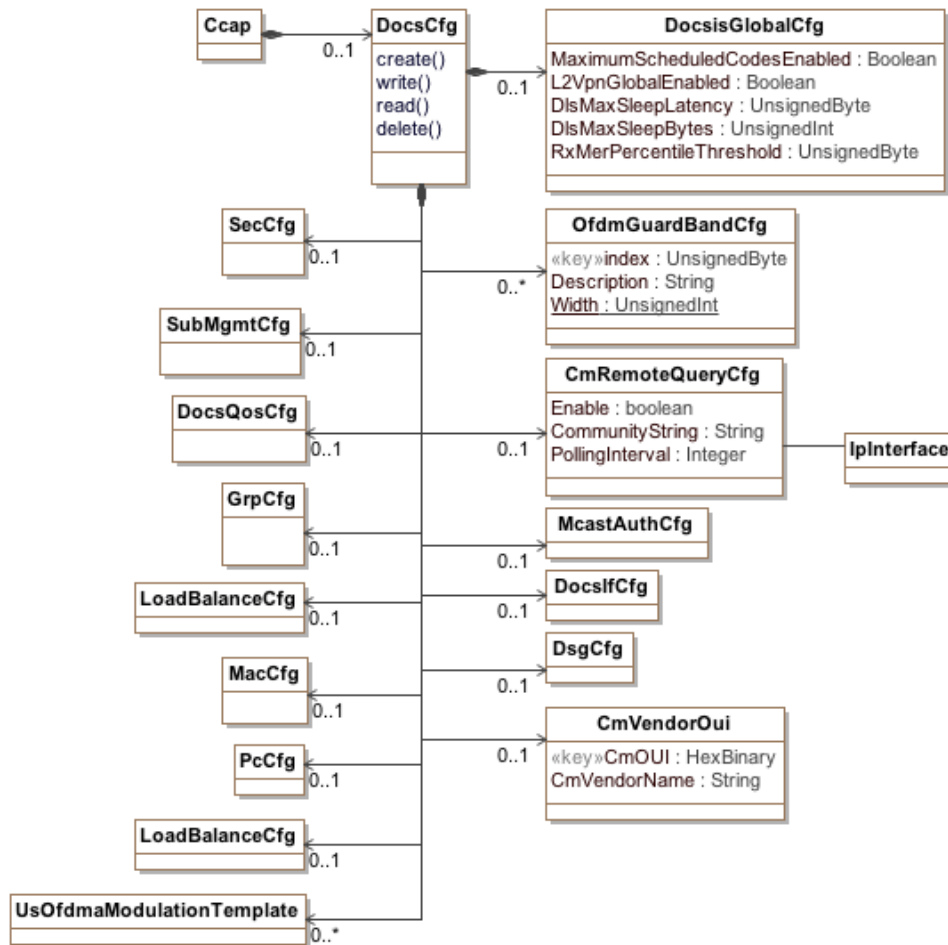

Figure 6-6 - DOCSIS Configuration Objects<sup>23</sup>

<sup>23</sup> Modified per CCAP-OSSv3.1-N-16.1440-3 on 5/13/16 by KB.

### 6.6.6.1.1 Ccap

This configuration object is included in Figure 6-6 for reference. It is defined in Section 6.6.3.1, Ccap Object.

### 6.6.6.1.2 DocsCfg

The DocsCfg object is the primary container of DOCSIS configuration objects. It has the following associations:

**Table 6-76 - DocsCfg Object Associations**

Associated Object Name	Type	Near-end Multiplicity	Far-end Multiplicity	Label
SecCfg	Directed composition to SecCfg		0..1	
SubMgmtCfg	Directed composition to SubMgmtCfg		0..1	
DocsQosCfg	Directed composition to DocsQosCfg		0..1	
GrpCfg	Directed composition to GrpCfg		0..1	
MacCfg	Directed composition to MacCfg		0..1	
PcCfg	Directed composition to PcCfg		0..1	
LoadBalanceCfg	Directed composition to LoadBalanceCfg		0..1	
DocsisGlobalCfg	Directed composition to DocsisGlobalCfg		0..1	
OfdmGuardBandCfg	Directed composition to OfdmGuardBandCfg		0..*	
CmRemoteQuery	Directed composition to CmRemoteQuery		0..1	
McastAuthCfg	Directed composition to McastAuthCfg		0..1	
DocslfCfg	Directed composition to DocslfCfg		0..1	
DsgCfg	Directed composition to DsgCfg		0..1	
CmVendorOUI	Directed composition to CmVendorOUI		0..1	
UsOfdmaModulationTemplate	Directed composition to UsOfdmaModulationTemplate		0..*	

### 6.6.6.1.3 SecCfg

This configuration object is included in Figure 6-6 for reference. It is defined in Section 6.6.6.2.3, SecCfg.

### 6.6.6.1.4 SubMgmtCfg

This configuration object is included in Figure 6-6 for reference. It is defined in Section 6.6.6.3.3, SubMgmtCfg.

### 6.6.6.1.5 DocsQosCfg

This configuration object is included in Figure 6-6 for reference. It is defined in Section 6.6.6.4.2, DocsQosCfg.

### 6.6.6.1.6 GrpCfg

This configuration object is included in Figure 6-6 for reference. It is defined in Section 6.6.6.5.3, GrpCfg.

### 6.6.6.1.7 MacCfg

This configuration object is included in Figure 6-6 for reference. It is defined in Section 6.6.6.6.3, MacCfg.

### 6.6.6.1.8 PcCfg

This configuration object is included in Figure 6-6 for reference. It is defined in Section 6.6.6.11.2, PcCfg.

### 6.6.6.1.9 LoadBalanceCfg

This configuration object is included in Figure 6-6 for reference. It is defined in Section 6.6.6.12, Load Balance Configuration Objects.

### 6.6.6.1.10 *DocsisGlobalCfg*

The *DocsisGlobalCfg* object defines DOCSIS configuration attributes for the entire system, such as enabling Maximum Scheduled Codes and L2VPN.

**Table 6-77 - *DocsisGlobalCfg* Object Attributes**

Attribute Name	Type	Required Attribute	Type Constraints	Units	Default Value
MaximumScheduledCodesEnabled	Boolean	Yes			
L2VpnGlobalEnabled	Boolean	No			False
DlsMaxSleepLatency	UnsignedByte	No	1..255	ms	100
DlsMaxSleepBytes	UnsignedInt	No	1..65535	bytes	1024

#### 6.6.6.1.10.1 *DocsisGlobalCfg* Object Attributes

##### 6.6.6.1.10.1.1 **MaximumScheduledCodesEnabled**

Indicates the global state of the Maximum Scheduled Codes feature on the CCAP. The value true indicates that this feature can be enabled on individual logical channels on the CCAP. The value false indicates that the feature is not in operation on the CCAP. Note that the CCAP object attribute *ScdmaChannelMscState* enables or disables Maximum Scheduled Codes on a per logical channel basis.

##### 6.6.6.1.10.1.2 **L2VpnGlobalEnabled**

This attribute will enable or disable on a global basis the configuration of L2VPN forwarding for all DOCSIS MAC domains. The default value is false. This attribute only enables L2VPN forwarding; configuration of the feature is handled in a vendor-specific way.

##### 6.6.6.1.10.1.3 **DlsMaxSleepLatency**

This attribute specifies the CCAP configuration for the amount of time a CM would allow an upstream channel to queue the packets without transitioning to DLS wake state.

##### 6.6.6.1.10.1.4 **DlsMaxSleepBytes**

This attribute specifies the CCAP configuration for the maximum number of bytes a CM would allow an upstream service flow to enqueue without transitioning to DLS wake state.

### 6.6.6.1.11 *McastAuthCfg*

This configuration object is included in Figure 6-6 for reference. It is defined in Section 6.6.6.7.3, *McastAuthCfg*.

### 6.6.6.1.12 *DocslfCfg*

This configuration object is included in Figure 6-6 for reference. It is defined in Section 6.6.6.8.2, *DocslfCfg*.

### 6.6.6.1.13 *DsgCfg*

This configuration object is included in Figure 6-6 for reference. It is defined in Section 6.6.6.10.2, *DsgCfg*.

### 6.6.6.1.14 *CmRemoteQuery*

This configuration object enables SNMP queries of CMs.

**Table 6-78 - CmRemoteQuery Object Attributes**

Attribute Name	Type	Required Attribute	Type Constraints	Units	Default Value
Enable	Boolean	Yes			
CommunityString	String	Yes			
PollingInterval	Integer	Yes		Seconds	

This object is associated with the source interface address on the CCAP.

**Table 6-79 - CmRemoteQuery Object Associations**

Associated Object Name	Type	Near-end Multiplicity	Far-end Multiplicity	Label
IpInterface	Association to IpInterface			

#### 6.6.6.1.14.1 CmRemoteQuery Object Attributes

##### 6.6.6.1.14.1.1 Enable

This attribute configures whether or not CM remote query is enabled on the CCAP.

##### 6.6.6.1.14.1.2 CommunityString

This attribute configures the SNMP Community String for remote queries.

##### 6.6.6.1.14.1.3 PollingInterval

This attribute configures the minimum amount of time in seconds between consecutive polls of the same MIB object on the same cable modem.

#### 6.6.6.1.15 CmVendorOui

This configuration object allows the operator to create a database of OUIs and Vendors.

**Table 6-80 - CmVendorOui Object Attributes**

Attribute Name	Type	Required Attribute	Type Constraints	Units	Default Value
CmOUI	HexBinary	Yes (Key)	size(3)		
CmVendorName	String	Yes			

#### 6.6.6.1.15.1 CmVendorOui Object Attributes

##### 6.6.6.1.15.1.1 CmOUI

This attribute configures the OUI portion of a given MAC address.

##### 6.6.6.1.15.1.2 CmVendorName

This attribute configures the company name of the vendor with the associated OUI.

#### 6.6.6.1.16 OfdmGuardBandCfg

This configuration object instantiates a list of guard band widths that can be associated with the upper and lower guard bands defined for an OFDM channel.

**Table 6-81 - OfdmGuardBandCfg Object Attributes**

Attribute Name	Type	Required Attribute	Type Constraints	Units	Default Value
Index	UnsignedByte	Yes (Key)			
Description	String	No			""
Width	UnsignedInt	Yes	0   1000000..177000000 0	Hz	

6.6.6.1.16.1 OfdmGuardBandCfg Object Attributes

**6.6.6.1.16.1.1 Index**

This attribute configures a unique index for this guard band width.

**6.6.6.1.16.1.2 Description**

This attribute allows an optional description of the guard band to be added to help identify its uses.

**6.6.6.1.16.1.3 Width**

This attribute allows the width in Hertz of the a guard band of the OFDM channel to be configured.

6.6.6.1.17 *UsOfdmaModulationTemplate*

This configuration object is included in Figure 6-6 for reference. It is defined in Section 6.6.6.8.16.

### 6.6.6.2 DOCSIS Security Configuration

This section details the DOCSIS configuration objects for Security features defined in DOCSIS 3.1. These objects have been modified from [OSSiv3.0] to remove the SMiv2 and SNMP attributes from the configured objects and attributes. The object model for these features is below. Refer to [SECV3.1] for detailed security requirements.

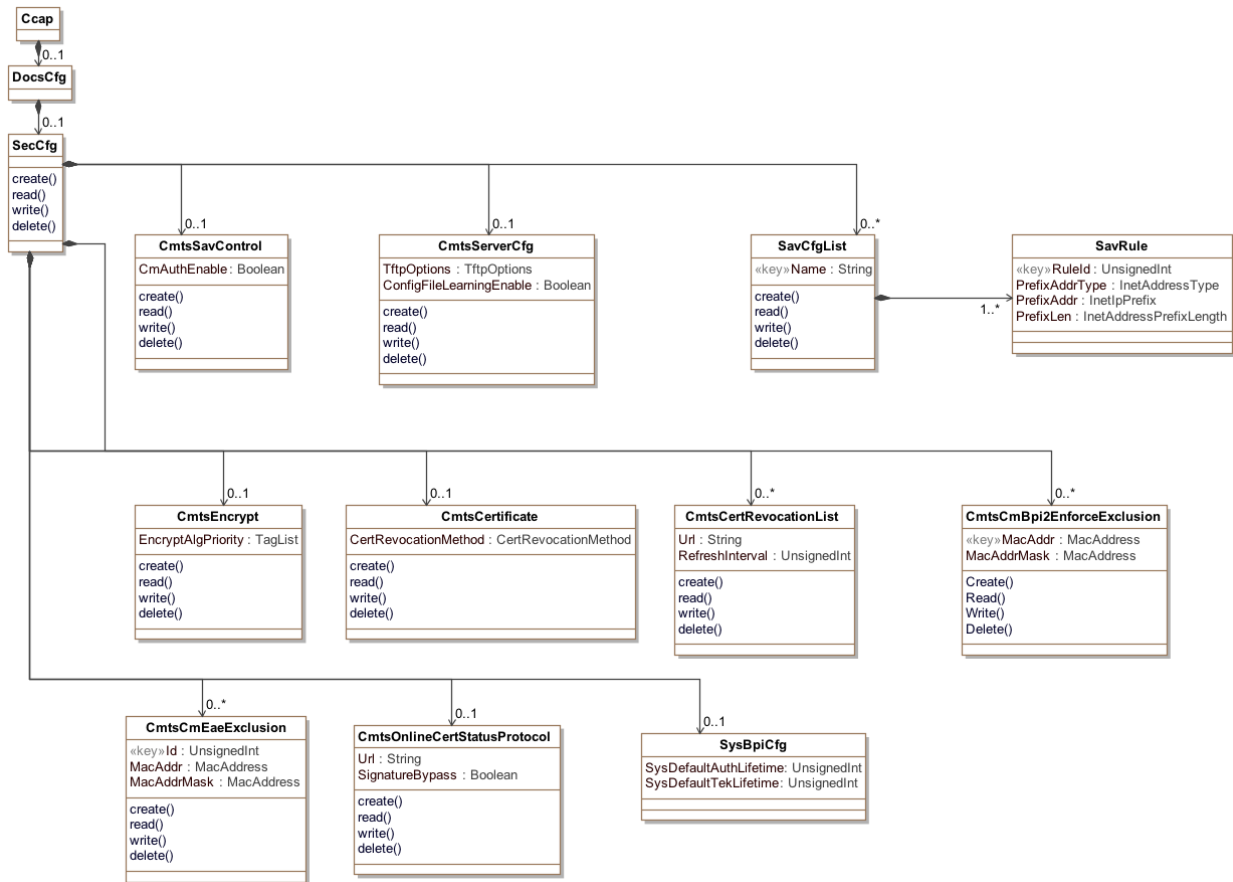

Figure 6-7 - DOCSIS Security Configuration Objects

#### 6.6.6.2.1 Ccap

This configuration object is included in Figure 6-7 for reference. It is defined in Section 6.6.3.1, Ccap Object.

#### 6.6.6.2.2 DocsCfg

This configuration object is included in Figure 6-7 for reference. It is defined in Section 6.6.6.1.2, DocsCfg.

#### 6.6.6.2.3 SecCfg

The SecCfg object is the primary container of DOCSIS security configuration objects. It has the following associations:

Table 6-82 - SecCfg Object Associations

Associated Object Name	Type	Near-end Multiplicity	Far-end Multiplicity	Label
SavCfgList	Directed composition to SavCfgList		0..*	
CmtsSavControl	Directed composition to CmtsSavControl		0..1	

Associated Object Name	Type	Near-end Multiplicity	Far-end Multiplicity	Label
CmtsServerCfg	Directed composition to CmtsServerCfg		0..1	
CmtsEncrypt	Directed composition to CmtsEncrypt		0..1	
CmtsCertificate	Directed composition to CmtsCertificate		0..1	
CmtsCertRevocationList	Directed composition to CmtsCertRevocationList		0..*	
CmtsCmEaeExclusion	Directed composition to CmtsCmEaeExclusion		0..*	
CmtsOnlineCertStatusProtocol	Directed composition to CmtsOnlineCertStatusProtocol		0..1	
SysBpiCfg	Directed composition to SysBpiCfg		0..1	
CmtsCmBpi2EnforceExclusion	Directed composition to CmtsCmBpi2EnforceExclusion		0..*	

#### 6.6.6.2.4 SavCfgList

This configuration object allows for the configuration of a Source Address Verification (SAV) list which can contain one or more rules for the Prefixes that are managed by this group.

This object supports the creation and deletion of multiple instances. Each object instance defines one CMTS SAV list that will contain 1 or more SAV rules. The SavRule Object will provide the configuration of each of the configured subnet prefix extension for which the CCAP performs source address verification.

Creation of a new instance of this object requires the Name attribute to be set.

Reference: [OSSv3.0], DOCS-SEC-MIB section

**Table 6-83 - SavCfgList Object Attributes**

Attribute Name	Type	Required Attribute	Type Constraints	Units	Default Value
Name	String	Yes (Key)			

**Table 6-84 - SavCfgList Object Associations**

Associated Object Name	Type	Near-end Multiplicity	Far-end Multiplicity	Label
SavRule	Directed composition to SavRule		1..*	

#### 6.6.6.2.4.1 SavCfgList Object Attributes

##### 6.6.6.2.4.1.1 Name

This attribute is the key that identifies the instance of the SavCmAuth object to which this object extension belongs.

#### 6.6.6.2.5 SavRule

This object supports the creation and deletion of multiple instances. Each object instance defines one CMTS configured subnet prefix extension for which the CCAP performs source address verification.

Creation of a new instance of this object requires the RuleId, PrefixAddrType, and PrefixAddr attributes to be set.

The CMTS and CCAP MUST persist all instances of SavCfgList across reinitializations.

**Table 6-85 - SavRule Object Attributes**

Attribute Name	Type	Required Attribute	Type Constraints	Units	Default
RuleId	UnsignedInt	key	1..4294967295		
PrefixAddrType	InetAddressType	Yes	ipv4(1), ipv6(2)		



Attribute Name	Type	Required Attribute	Type Constraints	Units	Default
PrefixAddr	InetAddress	Yes			
PrefixLen	InetAddressPrefixLength	No			0

#### 6.6.6.2.5.1 SavRule Object Attributes

##### 6.6.6.2.5.1.1 RuleId

This attribute is the key that identifies a particular subnet prefix rule of an instance of this object.

##### 6.6.6.2.5.1.2 PrefixAddrType

This attribute identifies the IP address type of this subnet prefix rule.

##### 6.6.6.2.5.1.3 PrefixAddr

This attribute corresponds to the IP address of this subnet prefix rule in accordance to the PrefixAddrType attribute.

##### 6.6.6.2.5.1.4 PrefixLen

This attribute defines the length of the subnet prefix to be matched by this rule.

#### 6.6.6.2.6 CmtsSavControl

This object defines attributes for global Source Address Verification (SAV) configuration.

The CMTS and CCAP MUST persist the values of the attributes of the CmtsSavCtrl object across reinitializations.

References: [SECv3.1] Secure Provisioning section.

**Table 6-86 - CmtsSavCtrl Object Attributes**

Attribute Name	Type	Required Attribute	Type Constraints	Units	Default
CmAuthEnable	Boolean	No			true

#### 6.6.6.2.6.1 CmtsSavControl Object Attributes

##### 6.6.6.2.6.1.1 CmAuthEnable

This attribute enables or disables Source Address Verification (SAV) for CM configured policies in the SavCmAuth object. If this attribute is set to 'false', the CM configured policies in the SavCmAuth object are ignored.

This attribute is only applicable when the SrcAddrVerificationEnabled attribute of the MdCfg object is 'true'.

References: Section 6.6.6.6.4

#### 6.6.6.2.7 CmtsServerCfg

This object defines attributes for configuring TFTP Configuration File Security features.

The CMTS and CCAP MUST persist the values of the attributes of the CmtsServerCfg object across reinitializations.

**Table 6-87 - CmtsServerCfg Object Attributes**

Attribute Name	Type	Required Attribute	Type Constraints	Units	Default
TftpOptions	EnumBits	No	hwAddr(0) netAddr(1)		"H"
ConfigFileLearningEnable	Boolean	No			true

6.6.6.2.7.1 CmtsServerCfg Object Attributes

**6.6.6.2.7.1.1 TftpOptions**

This attribute instructs the CMTS to insert the source IP address and/or MAC address of received TFTP packets into the TFTP option fields before forwarding the packets to the Config File server.

This attribute is only applicable when the TftpProxyEnabled attribute of the MdCfg object is 'true'.

References: Section 6.6.6.6.4

**6.6.6.2.7.1.2 ConfigFileLearningEnable**

This attribute enables and disables Configuration File Learning functionality.

If this attribute is set to 'true' the CMTS will respond with Authentication Failure in the REG-RSP message when there is a mismatch between learned config file parameters and REG-REQ parameters. If this attribute is set to 'false', the CMTS will not execute config file learning and mismatch check.

This attribute is only applicable when the TftpProxyEnabled attribute of the MdCfg object is 'true'.

References: Section 6.6.6.6.4; [SECv3.1] Secure Provisioning section; [MULPIv3.1].

6.6.6.2.8 CmtsEncrypt

This object includes an attribute that defines the order in which encryption algorithms are to be applied.

The CMTS and CCAP MUST persist the values of the attributes of the CmtsEncrypt object across reinitializations.

**Table 6-88 - CmtsEncrypt Object Attributes**

Attribute Name	Type	Required Attribute	Type Constraints	Units	Default
EncryptAlgPriority	TagList	No	aes128CbcMode des56CbcMode des40CbcMode		"aes128CbcMode des56CbcMode des40CbcMode"

6.6.6.2.8.1 CmtsEncrypt Object Attributes

**6.6.6.2.8.1.1 EncryptAlgPriority**

This attribute allows for configuration of a prioritized list of encryption algorithms the CMTS will use when selecting the primary SAID encryption algorithm for a given CM. The CMTS selects the highest priority encryption algorithm from this list that the CM supports. By default the following encryption algorithms are listed from highest to lowest priority (left being the highest): 128 bit AES, 56 bit DES, 40 bit DES.

An empty list indicates that the CMTS attempts to use the latest and robust encryption algorithm supported by the CM. The CMTS will ignore unknown values or unsupported algorithms.

6.6.6.2.9 CmtsCertificate

This object defines attributes for global certificate revocation configuration.

The CMTS and CCAP MUST persist the values of the attributes of the CertificateRevocationMethod object across reinitializations.

References: [SECV3.1] BPI+ X.509 Certificate Profile and Management section.

**Table 6-89 - CmtsCertificate Object Attributes**

Attribute Name	Type	Required Attribute	Type Constraints	Units	Default Value
CertRevocationMethod	Enum	No	other(1), none(2), crl(3), ocsp(4), crlAndOcsp(5)		none

#### 6.6.6.2.9.1 CmtsCertificate Object Attributes

##### 6.6.6.2.9.1.1 CertRevocationMethod

This attribute identifies which certificate revocation method is to be used by the CMTS to verify the cable modem certificate validity. The certificate revocation methods include Certification Revocation List (CRL) and Online Certificate Status Protocol (OCSP).

The following options are available:

The option 'other' indicates a vendor extension is in use.

The option 'none' indicates that the CMTS does not attempt to determine the revocation status of a certificate.

The option 'crl' indicates the CMTS uses a Certificate Revocation List (CRL) as defined by the Url attribute of the CmtsCertRevocationList object. When the value of this attribute is changed to 'crl', it triggers the CMTS to retrieve the CRL file from the URL specified by the Url attribute. If the value of this attribute is 'crl' when the CMTS starts up, it triggers the CMTS to retrieve the CRL file from the URL specified by the Url attribute.

The option 'ocsp' indicates the CMTS uses the Online Certificate Status Protocol (OCSP) as defined by the Url attribute of the CmtsOnlineCertStatusProtocol object.

The option 'crlAndOcsp' indicates the CMTS uses both the CRL as defined by the Url attribute in the CmtsCertRevocationList object and OCSP as defined by the Url attribute in the CmtsOnlineCertStatusProtocol object.

##### 6.6.6.2.10 CmtsCertRevocationList

This object defines a CRL location URL and periodic refresh interval value. The CRL location URL defines from where the CCAP will retrieve the CRL file. The periodic refresh interval value indicates how often the CCAP will retrieve the CRL file for updates if the tbsCertList.nextUpdate attribute in the file is absent.

This object is only applicable when the CertRevocationMethod attribute of the CmtsCertificate object is set to "crl" or "crlAndOcsp".

The CMTS and CCAP MUST persist the values of the Url and RefreshInterval attributes of the CmtsCertRevocationList object across reinitializations.

References: [SECV3.1] BPI+ X.509 Certificate Profile and Management section

**Table 6-90 - CmtsCertRevocationList Object Attributes**

Attribute Name	Type	Required Attribute	Type Constraints	Units	Default
Url	String	No	Uniform Resource Locator		""
RefreshInterval	UnsignedInt	No	1..524160	minutes	10080

6.6.6.2.10.1 CmtsCertRevocationList Object Attributes

**6.6.6.2.10.1.1 Url**

This attribute contains the URL from where the CMTS will retrieve the CRL file. When this attribute is set to a URL value different from the current value, it triggers the CMTS to retrieve the CRL file from that URL. If the value of this attribute is a zero-length string, the CMTS does not attempt to retrieve the CRL.

References: [SECV3.1] BPI+ X.509 Certificate Profile and Management section.

**6.6.6.2.10.1.2 RefreshInterval**

This attribute contains the refresh interval for the CMTS to retrieve the CRL (referred to in the Url attribute) with the purpose of updating its Certificate Revocation List. This attribute is meaningful if the tbsCertList.nextUpdate attribute does not exist in the last retrieved CRL.

References: [SECV3.1] BPI+ X.509 Certificate Profile and Management section.

*6.6.6.2.11 CmtsCmEaeExclusion*

This object defines a list of CMs or CM groups to exclude from Early Authentication and Encryption (EAE). This object allows overrides to the value of EAE Control for individual CMs or group of CMs for purposes such as debugging.

The CMTS and CCAP MUST support a minimum of 30 instances of the CmtsCmEaeExclusion object.

This object is only applicable when the EarlyAuthEncryptCtrl attribute of the MdCfg object is enabled.

This object supports the creation and deletion of multiple instances.

The CMTS and CCAP MUST persist all instances of CmtsCmEaeExclusion across reinitializations.

References: Section 6.6.6.6.4; [SECV3.1] Early Authentication and Encryption section.

**Table 6-91 - CmtsCmEaeExclusion Object Attributes**

Attribute Name	Type	Required Attribute	Type Constraints	Units	Default
Id	UnsignedInt	key	1..4294967295		
MacAddr	MacAddress	No			'000000000000'H
MacAddrMask	MacAddress	No			'FFFFFFFFFFFF'H

6.6.6.2.11.1 CmtsCmEaeExclusion Object Attributes

**6.6.6.2.11.1.1 Id**

This key uniquely identifies the exclusion MAC address rule.

**6.6.6.2.11.1.2 MacAddr**

This attribute identifies the CM MAC address. A match is made when a CM MAC address bitwise ANDed with the MacAddrMask attribute equals the value of this attribute.

**6.6.6.2.11.1.3 MacAddrMask**

This attribute identifies the CM MAC address mask and is used with the MacAddr attribute.

*6.6.6.2.12 CmtsOnlineCertStatusProtocol*

This object contains an OCSP Responder URL and an attribute to bypass signature checking of the OCSP response, as detailed in [RFC 2560]. The CCAP will use the URL for OCSP communications in checking a certificate's

revocation status. This object is only applicable when the CertRevocationMethod attribute of the CmtsCertificate object is set to "ocsp" or "crlAndOcsp".

The CMTS and CCAP MUST persist the values of the attributes of the CmtsOnlineCertStatusProtocol object across reinitializations.

**Table 6-92 - CmtsOnlineCertStatusProtocol Object Attributes**

Attribute Name	Type	Required Attribute	Type Constraints	Units	Default
Url	String	No	Uniform Resource Locator		""
SignatureBypass	Boolean	No			false

#### 6.6.6.2.12.1 CmtsOnlineCertStatusProtocol Object Attributes

##### 6.6.6.2.12.1.1 Url

This attribute contains the URL string to retrieve OCSP information. If the value of this attribute is a zero-length string, the CMTS does not attempt to request the status of a CM certificate.

References: [SECV3.1] BPI+ X.509 Certificate Profile and Management section; [RFC 2560].

##### 6.6.6.2.12.1.2 SignatureBypass

This attribute enables or disables signature checking on OCSP response messages.

References: [SECV3.1] BPI+ X.509 Certificate Profile and Management section; [RFC 2560].

#### 6.6.6.2.13 CmtsCmBpi2EnforceExclusion

This object defines a list of CMs or CM groups to exclude from BPI+ enforcement policies configured within the CMTS. This object allows overrides to the value of BPI+ enforcement control for individual CMs or group of CMs for purposes such as debugging. The CMTS MUST support a minimum of 30 instances of the CmtsCmBpi2EnforceExclusion object.

This object supports the creation and deletion of multiple instances.

The CMTS MUST persist all instances of CmtsCmBpi2EnforceExclusion across reinitializations.

References: Section 6.6.6.6.4; [SECV3.1] BPI+ Enforce section.

**Table 6-93 - CmtsCmBpi2EnforceExclusion Object Attributes**

Attribute Name	Type	Required Attribute	Type Constraints	Units	Default
MacAddr	MacAddress	Yes(key)			
MacAddrMask	MacAddress	No			'FFFFFFFFFFFF'H

#### 6.6.6.2.13.1 CmtsCmBpi2EnforceExclusion Object Attributes

##### 6.6.6.2.13.1.1 MacAddr

This attribute identifies the CM MAC address. A match is made when a CM MAC address bitwise ANDed with the MacAddrMask attribute equals the value of this attribute.

##### 6.6.6.2.13.1.2 MacAddrMask

This attribute identifies the CM MAC address mask and is used with the MacAddr attribute.

### 6.6.6.2.14 SysBpiCfg

This object is based on the DocsBpiCmtsBaseEntry table defined in [RFC 3083].

This object provides the configuration of the default Baseline Privacy key lifetimes. If not configured, the default values are vendor specific.

Reference: [RFC 3083]

**Table 6-94 - SysBpiCfg Object Attributes**

Attribute Name	Type	Required Attribute	Type Constraints	Units	Default
SysDefaultAuthLifetime	UnsignedInt	No		seconds	Vendor specific
SysDefaultTekLifetime	UnsignedInt	No		seconds	Vendor specific

#### 6.6.6.2.14.1 SysBpiCfg Object Attributes

##### 6.6.6.2.14.1.1 SysDefaultAuthLifetime

The value of this object is the default lifetime, in seconds, the CMTS assigns to a new authorization key.

##### 6.6.6.2.14.1.2 SysDefaultTekLifetime

The value of this object is the default lifetime, in seconds, the CMTS assigns to a new Traffic Encryption Key (TEK).

### 6.6.6.3 DOCSIS Subscriber Management Configuration

The Subscriber Management capabilities of the CMTS may be leveraged to control groups of CMs for the upstream and downstream direction of flow independently. Through configuration of group labels in the CM's configuration profile, a given CM's upstream and downstream filtering can be enforced directly at the CMTS, or delegated (in the case of the upstream direction only) to the CM (refer to [CM-OSSv3.1] for CM Protocol Filtering).

This model provides the Subscriber Management CMTS enforcement of packet filtering policies for CMs and CPE behind the CM, including maximum number of CM CPEs. The Subscriber Management model provides the CMTS with policy management of upstream and downstream filtering traffic on a CM basis through DOCSIS defined CPE types. The components of the Subscriber Management configuration model include:

- Base, default configuration parameters
- FilterGrp, list of classifiers of a filter group

Subscriber Management aligns the packet classification parameters of the filter groups with the QoS classification criteria. To that extent, as an optional CMTS feature, a Subscriber Management Filter Group ID or a set of those IDs can be associated with Upstream Drop Classifier Group ID(s) (see [MULPIv3.1]). In this situation the CMTS Subscriber Management Filter groups are provisioned to the CM in the form of Upstream Drop Classifiers (UDCs) during the registration process.

This group of configuration elements allows for the configuration of the Subscriber Management rules. The configuration specific Information Model is shown below.

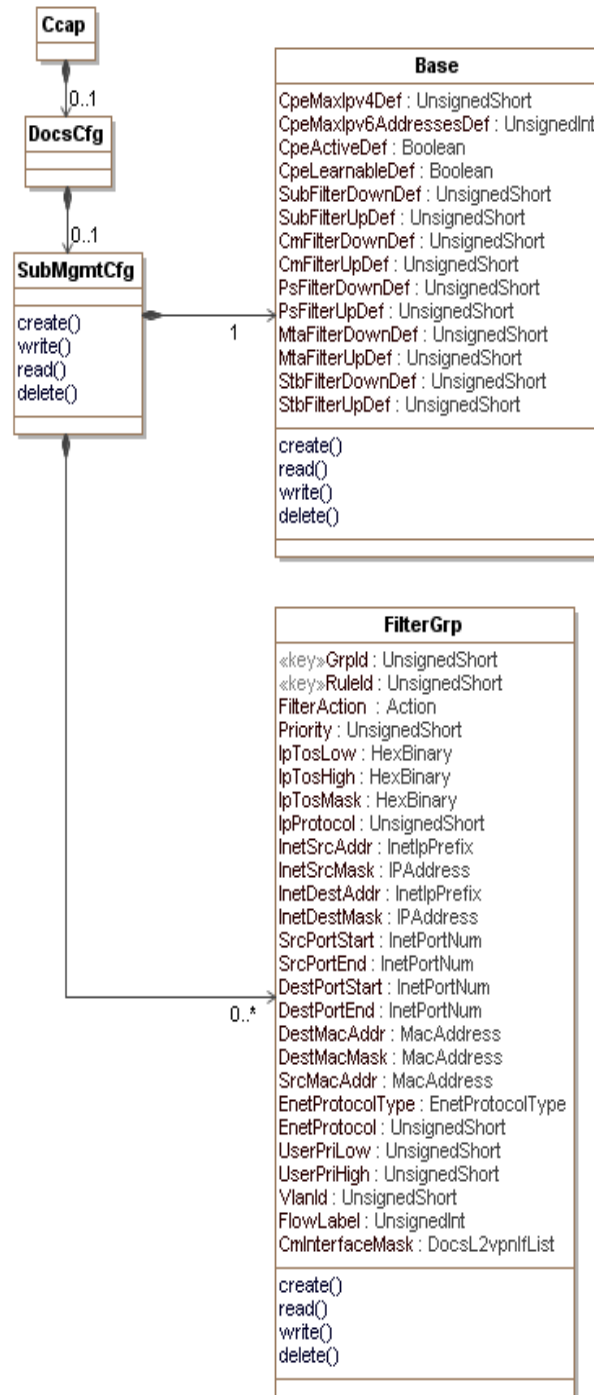

Figure 6-8 - DOCSIS Subscriber Management Configuration Objects

6.6.6.3.1 Ccap

This configuration object is included in Figure 6-8 for reference. It is defined in Section 6.6.3.1, Ccap Object.

6.6.6.3.2 *DocsCfg*

This configuration object is included in Figure 6-8 for reference. It is defined in Section 6.6.6.1.2, DocsCfg.

6.6.6.3.3 *SubMgmtCfg*

The SubMgmtCfg object is the primary container of DOCSIS security configuration objects. It has the following associations:

**Table 6-95 - SubMgmtCfg Object Associations**

Associated Object Name	Type	Near-end Multiplicity	Far-end Multiplicity	Label
Base	Directed composition to Base		1	
FilterGrp	Directed composition to FilterGrp		0..*	

6.6.6.3.4 *Base*<sup>24</sup>

This object defines the configuration parameters of Subscriber Management features for the CM in case the CM does not signal any of the parameters during the registration process.

**Table 6-96 - Base Object Attributes**

Attribute Name	Type	Required Attribute	Type Constraints	Units	Default
CpeMaxIpv4Def	UnsignedShort	No	0..1023		16
CpeMaxIpv6PrefixesDef	UnsignedShort	No	0..1023		3
CpeActiveDef	Boolean	No			false
CpeLearnableDef	Boolean	No			false
SubFilterDownDef	UnsignedShort	No	0..1024		0
SubFilterUpDef	UnsignedShort	No	0..1024		0
CmFilterDownDef	UnsignedShort	No	0..1024		0
CmFilterUpDef	UnsignedShort	No	0..1024		0
PsFilterDownDef	UnsignedShort	No	0..1024		0
PsFilterUpDef	UnsignedShort	No	0..1024		0
MtaFilterDownDef	UnsignedShort	No	0..1024		0
MtaFilterUpDef	UnsignedShort	No	0..1024		0
StbFilterDownDef	UnsignedShort	No	0..1024		0
StbFilterUpDef	UnsignedShort	No	0..1024		0

6.6.6.3.4.1 Base Object Attributes

6.6.6.3.4.1.1 **CpeMaxIpv4Def**

This attribute represents the maximum number of IPv4 addresses allowed for the CM's CPE if not signaled in the registration process.

6.6.6.3.4.1.2 **CpeMaxIpv6PrefixesDef**

This attribute represents the maximum number of IPv6 IA\_PD's (delegated prefixes) allowed for the CM's CPEs. IPv6 IA\_PD's are counted against the 'CpeMaxIpv6PrefixesDef'. This contrasts with the CpeMaxIPV4AddressesDef attribute which controls the maximum number of individual IPv4 addresses. Because this attribute only counts IA\_PD's against the default, IA\_NA addresses and Link-Local addresses are not counted against this default limit.

<sup>24</sup> Table and subsections modified per CCAP-OSSlv3.1-N-15.1321-1 on 7/20/15 by KB.



**6.6.6.3.4.1.3 CpeActiveDef**

This attribute represents the default value for enabling Subscriber Management filters and controls in the CM if the parameter is not signaled in the DOCSIS Registration process.

**6.6.6.3.4.1.4 CpeLearnableDef**

This attribute represents the default value for enabling the CPE learning process for the CM if the parameter is not signaled in the DOCSIS Registration process.

**6.6.6.3.4.1.5 SubFilterDownDef**

This attribute represents the default value for the subscriber (CPE) downstream filter group for the CM if the parameter is not signaled in the DOCSIS Registration process.

**6.6.6.3.4.1.6 SubFilterUpDef**

This attribute represents the default value for the subscriber (CPE) upstream filter group for the CM if the parameter is not signaled in the DOCSIS Registration process.

**6.6.6.3.4.1.7 CmFilterDownDef**

This attribute represents the default value for the CM stack downstream filter group applying to the CM if the parameter is not signaled in the DOCSIS Registration process.

**6.6.6.3.4.1.8 CmFilterUpDef**

This attribute represents the default value for the CM stack upstream filter group for the CM if the parameter is not signaled in the DOCSIS Registration process.

**6.6.6.3.4.1.9 PsFilterDownDef**

This attribute represents the default value for the PS or eRouter downstream filter group for the CM if the parameter is not signaled in the DOCSIS Registration process.

**6.6.6.3.4.1.10 PsFilterUpDef**

This attribute represents the default value for the PS or eRouter upstream filter group for the CM if the parameter is not signaled in the DOCSIS Registration process.

**6.6.6.3.4.1.11 MtaFilterDownDef**

This attribute represents the default value for the MTA downstream filter group for the CM if the parameter is not signaled in the DOCSIS Registration process.

**6.6.6.3.4.1.12 MtaFilterUpDef**

This attribute represents the default value for the MTA upstream filter group for the CM if the parameter is not signaled in the DOCSIS Registration process.

**6.6.6.3.4.1.13 StbFilterDownDef**

This attribute represents the default value for the STB downstream filter group for the CM if the parameter is not signaled in the DOCSIS Registration process.

**6.6.6.3.4.1.14 StbFilterUpDef**

This attribute represents the default value for the STB upstream filter group for the CM if the parameter is not signaled in the DOCSIS Registration process.

6.6.6.3.5 FilterGrp

This object describes a set of filter or classifier criteria. Classifiers are assigned by group to the individual CMs. That assignment is made via the "Subscriber Management TLVs" encodings sent upstream from the CM to the CCAP during registration, or in their absence, default values configured in the CCAP.

A Filter Group ID (GrpId) is a set of rules that correspond to the expansion of a UDC Group ID into individual UDC rules. The UDC Group IDs are linked to IDs of the FilterGrp object so the CCAP can signal those filter rules as UDCs to the CM during the registration process. Implementation of L2 classification criteria is optional for the CCAP; LLC/MAC upstream and downstream filter criteria can be ignored during the packet matching process.

**Table 6-97 - FilterGrp Object Attributes**

Attribute Name	Type	Required Attribute	Type Constraints	Units	Default Value
GrpId	UnsignedShort	Key	1..1024		
RuleId	UnsignedShort	Key	1..65535		
FilterAction	Enum	No	other(1), permit(2), deny(3)		permit
Priority	UnsignedShort	No			0
IpTosLow	HexBinary	No	SIZE (1)		'00'H
IpTosHigh	HexBinary	No	SIZE (1)		'00'H
IpTosMask	HexBinary	No	SIZE (1)		'00'H
IpProtocol	UnsignedShort	No	0..257		256
InetSrcAddr	InetAddress	No			"H
InetSrcMask	InetAddress	No			"H
InetDestAddr	InetAddress	No			"H
InetDestMask	InetAddress	No			"H
SrcPortStart	InetPortNumber	No			0
SrcPortEnd	InetPortNumber	No			65535
DestPortStart	InetPortNumber	No			0
DestPortEnd	InetPortNumber	No			65535
DestMacAddr	MacAddress	No			'000000000000'H
DestMacMask	MacAddress	No			'000000000000'H
SrcMacAddr	MacAddress	No			'FFFFFFFFFFFF'H
EnetProtocolType	Enum	No	other(1), none(2), ethertype(3), dsap(4), mac(5), all(6)		ethertype
EnetProtocol	UnsignedShort	No			0
UserPriLow	UnsignedShort	No	0..7		0
UserPriHigh	UnsignedShort	No	0..7		7
VlanId	UnsignedShort	No	0   1..4094		0
ClassPkts	Counter64	No			
FlowLabel	UnsignedInt	No	0..1048575		0
CmInterfaceMask	DocsL2vpnIfList	No			"H

6.6.6.3.5.1 FilterGrp Object Attributes

6.6.6.3.5.1.1 GrpId

This key is an identifier for a set of classifiers known as a filter group. Each CM may be associated with several filter groups for its upstream and downstream traffic, one group per target end point on the CM as defined in the Grp object. Typically, many CMs share a common set of filter groups. The range for this attribute is 1 to 1024 to align it with the values used in the Base Object.

#### **6.6.6.3.5.1.2 RuleId**

This key represents an ordered classifier identifier within the group. Filters are applied in order if the Priority attribute is not supported.

#### **6.6.6.3.5.1.3 FilterAction**

This attribute represents the action to take upon this filter matching. 'permit' means to stop the classification matching and accept the packet for further processing. 'deny' means to drop the packet. 'other' indicates a vendor extension is in use.

#### **6.6.6.3.5.1.4 Priority**

This attribute defines the order in which the classifiers are compared against packets. The higher the value, the higher the priority.

#### **6.6.6.3.5.1.5 IpTosLow**

This attribute represents the low value of a range of ToS (Type of Service) octet values. The IP ToS octet, as originally defined in [RFC 791], has been superseded by the 6-bit Differentiated Services Field (DSField, [RFC 3260]) and the 2-bit Explicit Congestion Notification Field (ECN field, [RFC 3168]). This attribute is defined as an 8-bit octet as per the DOCSIS Specification for packet classification.

References: [MULPIv3.1]; [RFC 791]; [RFC 3168]; [RFC 3260].

#### **6.6.6.3.5.1.6 IpTosHigh**

This attribute represents the high value of a range of ToS octet values. The IP ToS octet, as originally defined in [RFC 791], has been superseded by the 6-bit Differentiated Services Field (DSField, [RFC 3260]) and the 2-bit Explicit Congestion Notification Field (ECN field, [RFC 3168]). This attribute is defined as an 8-bit octet as per the DOCSIS Specification for packet classification.

References: [MULPIv3.1]; [RFC 791]; [RFC 3168]; [RFC 3260].

#### **6.6.6.3.5.1.7 IpTosMask**

This attribute represents the mask value that is bitwise ANDed with ToS octet in an IP packet, and the resulting value is used for range checking of IpTosLow and IpTosHigh.

#### **6.6.6.3.5.1.8 IpProtocol**

This attribute represents the value of the IP Protocol field required for IP packets to match this rule. The value 256 matches traffic with any IP Protocol value. The value 257 by convention matches both TCP and UDP.

#### **6.6.6.3.5.1.9 InetSrcAddr**

This attribute specifies the value of the IP Source Address required for packets to match this rule. An IP packet matches the rule when the packet's IP Source Address bitwise ANDed with the InetSrcMask value equals the InetSrcAddr value. The address type of this object is specified by the InetAddrType attribute.

#### **6.6.6.3.5.1.10 InetSrcMask**

This attribute represents which bits of a packet's IP Source Address are compared to match this rule. An IP packet matches the rule when the packet's IP Source Address bitwise ANDed with the InetSrcMask value equals the InetSrcAddr value. The address type of this object is specified by InetAddrType.

#### **6.6.6.3.5.1.11 InetDestAddr**

This attribute specifies the value of the IP Destination Address required for packets to match this rule. An IP packet matches the rule when the packet's IP Destination Address bitwise ANDed with the InetSrcMask value equals the InetDestAddr value. The address type of this object is specified by the InetAddrType attribute.

#### **6.6.6.3.5.1.12 InetDestMask**

This attribute represents which bits of a packet's IP Destination Address are compared to match this rule. An IP packet matches the rule when the packet's IP Destination Address bitwise ANDed with the InetDestMask value equals the InetDestAddr value. The address type of this object is specified by InetAddrType.

#### **6.6.6.3.5.1.13 SrcPortStart**

This attribute represents the low-end inclusive range of TCP/UDP source port numbers to which a packet is compared. This attribute is irrelevant for non-TCP/UDP IP packets.

#### **6.6.6.3.5.1.14 SrcPortEnd**

This attribute represents the high-end inclusive range of TCP/UDP source port numbers to which a packet is compared. This attribute is irrelevant for non-TCP/UDP IP packets.

#### **6.6.6.3.5.1.15 DestPortStart**

This attribute represents the low-end inclusive range of TCP/UDP destination port numbers to which a packet is compared. This attribute is irrelevant for non-TCP/UDP IP packets.

#### **6.6.6.3.5.1.16 DestPortEnd**

This attribute represents the high-end inclusive range of TCP/UDP destination port numbers to which a packet is compared. This attribute is irrelevant for non-TCP/UDP IP packets.

#### **6.6.6.3.5.1.17 DestMacAddr**

This attribute represents the criteria to match against an Ethernet packet MAC address bitwise ANDed with DestMacMask.

#### **6.6.6.3.5.1.18 DestMacMask**

An Ethernet packet matches an entry when its destination MAC address bitwise ANDed with the DestMacMask attribute equals the value of the DestMacAddr attribute.

#### **6.6.6.3.5.1.19 SrcMacAddr**

This attribute represents the value to match against an Ethernet packet source MAC address.

#### **6.6.6.3.5.1.20 EnetProtocolType**

This attribute indicates the format of the layer 3 protocol ID in the Ethernet packet. A value of 'none' means that the rule does not use the layer 3 protocol type as a matching criteria. A value of 'ethertype' means that the rule applies only to frames that contain an EtherType value. Ethertype values are contained in packets using the DEC-Intel-Xerox (DIX) encapsulation or the [RFC 1042] Sub-Network Access Protocol (SNAP) encapsulation formats. A value of 'dsap' means that the rule applies only to frames using the IEEE802.3 encapsulation format with a Destination Service Access Point (DSAP) other than 0xAA (which is reserved for SNAP). A value of 'mac' means that the rule applies only to MAC management messages for MAC management messages. A value of 'all' means that the rule matches all Ethernet packets. If the Ethernet frame contains an 802.1p/Q Tag header (i.e., EtherType 0x8100), this attribute applies to the embedded EtherType field within the 802.1p/Q header.

The value 'mac' is only used for passing UDCs to CMs during Registration. The CMTS ignores filter rules that include the value of this attribute set to 'mac' for CMTS enforced upstream and downstream subscriber management filter group rules.

The value 'other' indicates a vendor extension is in use.

References: [RFC 1042] Sub-Network Access Protocol (SNAP) encapsulation formats.

#### 6.6.6.3.5.1.21 EnetProtocol

This attribute represents the Ethernet protocol type to be matched against the packets. For EnetProtocolType set to 'none', this attribute is ignored when considering whether a packet matches the current rule. If the attribute EnetProtocolType is 'ethertype', this attribute gives the 16-bit value of the EtherType that the packet needs to match in order to match the rule. If the attribute EnetProtocolType is 'dsap', the lower 8 bits of this attribute's value needs to match the DSAP byte of the packet in order to match the rule. If the Ethernet frame contains an 802.1p/Q Tag header (i.e., EtherType 0x8100), this attribute applies to the embedded EtherType field within the 802.1p/Q header.

#### 6.6.6.3.5.1.22 UserPriLow

This attribute applies only to Ethernet frames using the 802.1p/Q tag header (indicated with EtherType 0x8100). Such frames include a 16-bit Tag that contains a 3-bit Priority field and a 12-bit VLAN number. Tagged Ethernet packets needs to have a 3-bit Priority field within the range of PriLow to PriHigh in order to match this rule.

#### 6.6.6.3.5.1.23 UserPriHigh

This attribute applies only to Ethernet frames using the 802.1p/Q tag header (indicated with EtherType 0x8100). Such frames include a 16-bit Tag that contains a 3-bit Priority field and a 12-bit VLAN number. Tagged Ethernet packets needs to have a 3-bit Priority field within the range of PriLow to PriHigh in order to match this rule.

#### 6.6.6.3.5.1.24 VlanId

This attribute applies only to Ethernet frames using the 802.1p/Q tag header. Tagged packets need to have a VLAN Identifier that matches the value in order to match the rule.

#### 6.6.6.3.5.1.25 FlowLabel

This attribute represents the Flow Label field in the IPv6 header to be matched by the classifier.

The value zero indicates that the Flow Label is not specified as part of the classifier and is not matched against packets.

#### 6.6.6.3.5.1.26 CmInterfaceMask

This attribute represents a bit-mask of the CM in-bound interfaces to which this classifier applies. This attribute only applies to upstream Drop Classifiers being sent to CMs during the registration process.

### 6.6.6.4 DOCSIS QoS Configuration<sup>25</sup>

This group of configuration elements allows for the configuration of DOCSIS QoS. The configuration specific object model is shown below.

The QosProfile object has been deprecated and removed from Figure 6-9 since the DOCSIS 1.0 Class of Service (CoS) service class definition type was deprecated and is not supported in DOCSIS 3.1.

---

<sup>25</sup> Modified per CCAP-OSSiv3.1-N-16.1618-3 on 11/17/16 by KB.

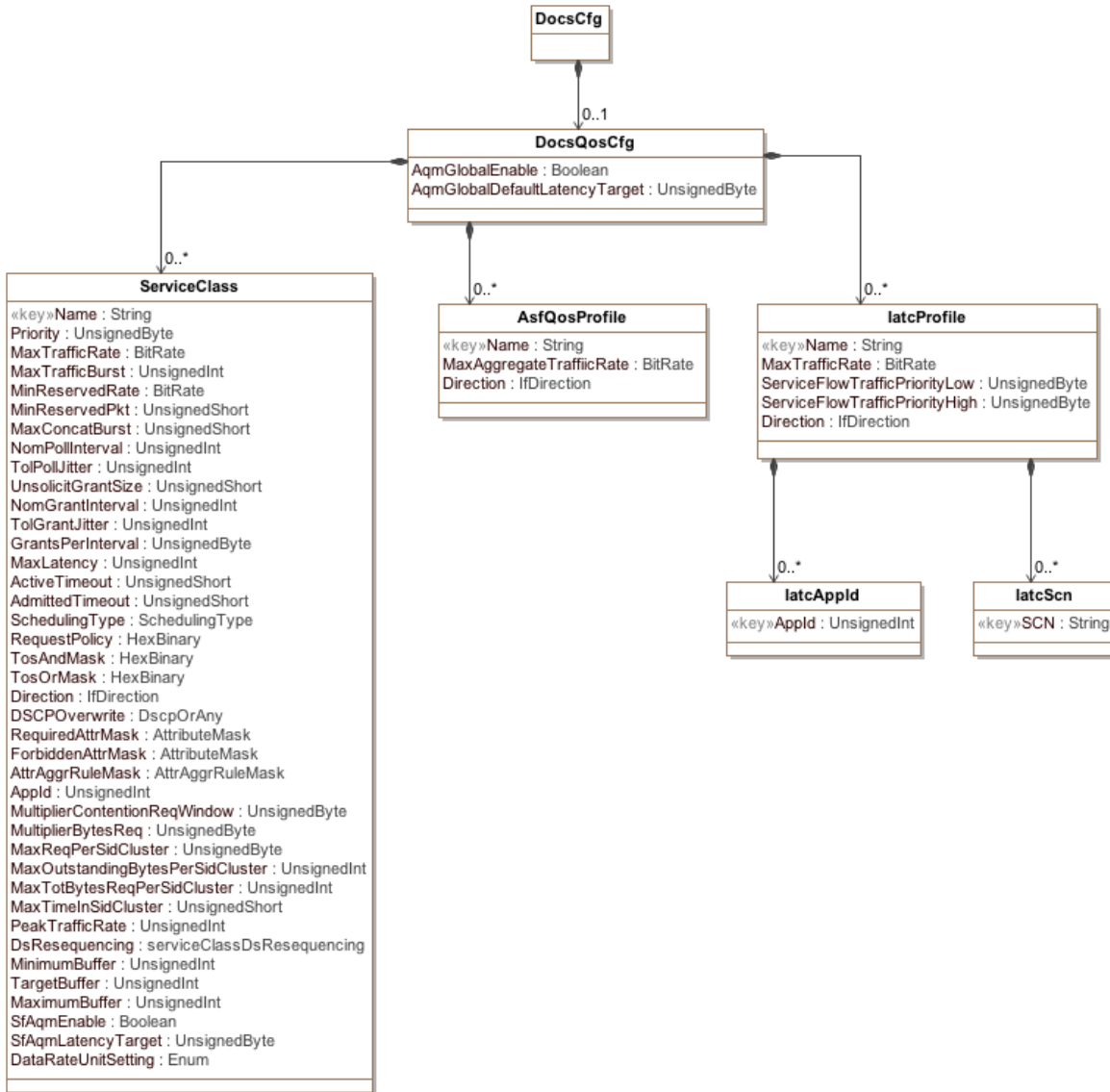

Figure 6-9 - DOCSIS QoS Configuration Objects

6.6.6.4.1 DocsCfg

This configuration object is included in Figure 6-9 for reference. It is defined in Section 6.6.6.1.2, DocsCfg.

6.6.6.4.2 DocsQosCfg

The DocsQosCfg object is the primary container of DOCSIS QoS configuration objects. It also sets global parameters for DOCSIS 3.1 Active Queue Management features.

Table 6-98 - DocsQosCfg Object Attributes

Attribute Name	Type	Required Attribute	Type Constraints	Units	Default Value
AqmGlobalEnable	Boolean	Yes			
AqmGlobalDefaultLatencyTarget	UnsignedInt	No		milliseconds	0

#### 6.6.6.4.2.1 DocsQosCfg Object Attributes

##### 6.6.6.4.2.1.1 AqmGlobalEnable

Indicates the global state of the Active Queue Management feature on the CCAP. The value true indicates that this feature can be enabled on individual service flows on the CCAP. The value false indicates that the feature is not in operation on the CCAP.

Reference: [MULPIv3.1] Active Queue Management section.

##### 6.6.6.4.2.1.2 AqmGlobalDefaultLatencyTarget

This attribute configures the target latency for service flows operating under Active Queue Management.

Reference: [MULPIv3.1] Active Queue Management section.

**Table 6-99 - DocsQosCfg Object Associations**

Associated Object Name	Type	Near-end Multiplicity	Far-end Multiplicity	Label
ServiceClass	Directed composition to ServiceClass		0..*	
QosProfile	Directed composition to QosProfile		0..*	
AsfQosProfile	Directed composition to AsfQosProfile		0..*	
latcProfile	Directed composition to latcProfile		0..*	

#### 6.6.6.4.3 ServiceClass

This object describes a provisioned service class on a CCAP. Each object instance defines a template for certain DOCSIS QoS Parameter Set values. When a CM creates or modifies an Admitted QoS Parameter Set for a Service Flow, it may reference a Service Class Name instead of providing explicit QoS Parameter Set values. In this case, the CCAP populates the QoS Parameter Set with the applicable corresponding values from the named Service Class. Subsequent changes to a Service Class row do not affect the QoS Parameter Set values of any service flows already admitted. A service class template applies to only a single direction, as indicated in the ServiceClassDirection attribute.

**Table 6-100 - ServiceClass Object Attributes<sup>26</sup>**

Attribute Name	Type	Required Attribute	Type Constraints	Units	Default Value
Name	String	key	1..16		
Priority	UnsignedByte	No			0
MaxTrafficRate	BitRate	No		bps	0
MaxTrafficBurst	UnsignedInt	No		bytes	See attribute description
MinReservedRate	BitRate	No		bps	0
MinReservedPkt	UnsignedShort	No		bytes	
MaxConcatBurst	UnsignedShort	No		bytes	1522
NomPollInterval	UnsignedInt	No		microseconds	0
TolPollJitter	UnsignedInt	No		microseconds	0
UnsolicitGrantSize	UnsignedShort	No		bytes	0
NomGrantInterval	UnsignedInt	No		microseconds	0
TolGrantJitter	UnsignedInt	No		microseconds	0
GrantsPerInterval	UnsignedByte	No		datagrants	0
MaxLatency	UnsignedInt	No		microseconds	0
ActiveTimeout	UnsignedShort	No		seconds	0
AdmittedTimeout	UnsignedShort	No		seconds	200

<sup>26</sup> Modified per CCAP-OSSiv3.0-N-15.1256-1 on 3/2/15 by KB.

Attribute Name	Type	Required Attribute	Type Constraints	Units	Default Value
SchedulingType	SchedulingType	No	other(1), bestEffort(2), nonRealTimePollingService(3), realTimePollingService(4), unsolicitedGrantServiceWithAD(5), unsolicitedGrantService(6)		bestEffort
RequestPolicy	HexBinary	No			'00000000'H
TosAndMask	HexBinary	No	SIZE(1)		
TosOrMask	HexBinary	No	SIZE(1)		
Direction	IfDirection	No			upstream
DSCPOverwrite	DscpOrAny	No			-1
RequiredAttrMask	AttributeMask	No			'00000000'H
ForbiddenAttrMask	AttributeMask	No			'00000000'H
AttrAggregationMask	AttrAggrRuleMask	No			'00000000'H
Appld	UnsignedInt	No			
MultiplierContentionReqWindow	UnsignedByte	No	4..12	eighths	8
MultiplierBytesReq	UnsignedByte	No	1   2   4   8   16		4
MaxReqPerSidCluster	UnsignedByte	No		requests	0
MaxOutstandingBytesPerSidCluster	UnsignedInt	No		bytes	0
MaxTotBytesReqPerSidCluster	UnsignedInt	No		bytes	0
MaxTimeInSidCluster	UnsignedShort	No		milliseconds	0
PeakTrafficRate	UnsignedInt	No		bps	0
DsResequencing	Enum	No	other(1), resequencingDcid(2), noResequencingDcid(3)		resequencingDcid
MinimumBuffer	UnsignedInt	No		bytes	0
TargetBuffer	UnsignedInt	No		bytes	0
MaximumBuffer	UnsignedInt	No	0..4294967295	bytes	4294967295
SfAqmEnable	Boolean	Yes			
SfAqmLatencyTarget	UnsignedByte	No		milliseconds	0
DataRateUnitSetting	Enum		bps(0), kbps(1), Mbps(2), Gbps(3),		

6.6.6.4.3.1 ServiceClass Object Attributes

6.6.6.4.3.1.1 Name

This key indicates the Service Class Name associated with this object instance. DOCSIS specifies that the maximum size is 16 ASCII characters including a terminating zero.

References: [MULPIv3.1] Service Class Name section in the Common Radio Frequency Interface Encodings Annex.

6.6.6.4.3.1.2 Priority

This attribute is the template for the Priority attribute of the QoS Parameter Set.

6.6.6.4.3.1.3 MaxTrafficRate

This attribute is the template for the MaxTrafficRate attribute of the QoS Parameter Set.



**6.6.6.4.3.1.4 MaxTrafficBurst**

This attribute is the template for the MaxTrafficBurst attribute of the QoS Parameter Set. If this value is not set, the default for DOCSIS 3.0 is 3044, and for DOCSIS 3.1 the default value is 3044, or 4000 if support for extended packet size is enabled.

**6.6.6.4.3.1.5 MinReservedRate**

This attribute is the template for the MinReservedRate attribute of the QoS Parameter Set.

**6.6.6.4.3.1.6 MinReservedPkt**

This attribute is the template for the MinReservedPkt attribute of the QoS Parameter Set. Vendor-dependent.

**6.6.6.4.3.1.7 MaxConcatBurst**

This attribute is the template for the MaxConcatBurst attribute of the QoS Parameter Set.

**6.6.6.4.3.1.8 NomPollInterval**

This attribute is the template for the NomPollInterval attribute of the QoS Parameter Set.

**6.6.6.4.3.1.9 TolPollJitter**

This attribute is the template for the TolPolJitter attribute of the QoS Parameter Set.

**6.6.6.4.3.1.10 UnsolicitGrantSize**

This attribute is the template for the UnsolicitGrantSize attribute of the QoS Parameter Set.

**6.6.6.4.3.1.11 NomGrantInterval**

This attribute is the template for the NomGrantInterval attribute of the QoS Parameter Set.

**6.6.6.4.3.1.12 TolGrantJitter**

This attribute is the template for the TolGrantJitter attribute of the QoS Parameter Set.

**6.6.6.4.3.1.13 GrantsPerInterval**

This attribute is the template for the GrantsPerInterval attribute of the QoS Parameter Set.

**6.6.6.4.3.1.14 MaxLatency**

This attribute is the template for the MaxLatency attribute of the QoS Parameter Set.

**6.6.6.4.3.1.15 ActiveTimeout**

This attribute is the template for the ActiveTimeout attribute of the QoS Parameter Set.

**6.6.6.4.3.1.16 AdmittedTimeout**

This attribute is the template for the AdmittedTimeout attribute of the QoS Parameter Set.

**6.6.6.4.3.1.17 SchedulingType**

This attribute is the template for the SchedulingType attribute of the QoS Parameter Set. A value of 'other' indicates a vendor extension is in use.

**6.6.6.4.3.1.18 RequestPolicy**

This attribute is the template for the RequestPolicyOct attribute of the QoS Parameter Set.

**6.6.6.4.3.1.19 TosAndMask**

This attribute is the template for the TosAndMask attribute of the QoS Parameter Set.

**6.6.6.4.3.1.20 TosOrMask**

This attribute is the template for the TosOrMask attribute of the QoS Parameter Set.

**6.6.6.4.3.1.21 Direction**

This attribute is the template for the Direction attribute of the QoS Parameter Set. A value of 'other' indicates a vendor extension is in use.

**6.6.6.4.3.1.22 DSCPOverwrite**

This attribute allows the overwrite of the DSCP field per [RFC 3260].

If this attribute is -1, then the corresponding TosAndMask value is set to be 'FF'H and TosOrMask is set to '00'H. Otherwise, this attribute is in the range of 0..63, and the corresponding TosAndMask value is '03'H and TosOrMask value is this attribute value shifted left by two bit positions.

**6.6.6.4.3.1.23 RequiredAttrMask**

This attribute is the template for the RequiredAttrMask attribute of the QoS Parameter Set.

**6.6.6.4.3.1.24 ForbiddenAttrMask**

This attribute is the template for the ForbiddenAttrMask attribute of the QoS Parameter Set.

**6.6.6.4.3.1.25 AttrAggrRuleMask**

This attribute is the template for the AttrAggregationMask attribute of the QoS Parameter Set.

**6.6.6.4.3.1.26 AppId**

This attribute is the template for the AppId attribute of the QoS Parameter Set.

**6.6.6.4.3.1.27 MultiplierContentionReqWindow**

This attribute is the template for the MultiplierContentionReqWindow attribute of the QoS Parameter Set.

**6.6.6.4.3.1.28 MultiplierBytesReq**

This attribute is the template for the MultiplierBytesReq attribute of the QoS Parameter Set.

**6.6.6.4.3.1.29 MaxReqPerSidCluster**

This attribute is the template for the MaxReqPerSidCluster attribute of the QoS Parameter Set. A value of 0 means unlimited.

**6.6.6.4.3.1.30 MaxOutstandingBytesPerSidCluster**

This attribute is the template for the MaxOutstandingBytesPerSidCluster attribute of the QoS Parameter Set. A value of 0 means unlimited.

**6.6.6.4.3.1.31 MaxTotBytesReqPerSidCluster**

This attribute is the template for the MaxTotBytesReqPerSidCluster attribute of the QoS Parameter Set. A value of 0 means unlimited.

#### 6.6.6.4.3.1.32 MaxTimeInSidCluster

This attribute is the template for the MaxTimeInSidCluster attribute of the QoS Parameter Set. A value of 0 means unlimited.

#### 6.6.6.4.3.1.33 PeakTrafficRate

This attribute is the template for the PeakTrafficRate attribute of the QoS Parameter Set. A value of 0 means the downstream peak traffic rate is not limited.

#### 6.6.6.4.3.1.34 DsResequencing

This attribute is the template for the DsResequencing attribute of the QoS Parameter Set. A value of 'other' indicates a vendor extension is in use.

#### 6.6.6.4.3.1.35 MinimumBuffer

This attribute is the template for the MinimumBuffer attribute of the QoS Parameter Set.

#### 6.6.6.4.3.1.36 TargetBuffer

This attribute is the template for the TargetBuffer attribute of the QoS Parameter Set. A value of 0 means that a vendor-specific default value is used.

#### 6.6.6.4.3.1.37 MaximumBuffer

This attribute is the template for the MaximumBuffer attribute of the QoS Parameter Set. A value of 4294967295 means unlimited.

#### 6.6.6.4.3.1.38 SfAqmEnable

If AqmGlobalEnable in the DocsQosCfg object is set to "true", this attribute indicates the state of the Active Queue Management feature for this ServiceClass. The value true indicates that this feature is enabled for this service class. The value false indicates that the feature is not active for this service class. This attribute applies to both upstream and downstream service flows. If AqmGlobalEnable in the DocsQosCfg object is set to "false", this attribute is ignored.

Reference: [MULPIv3.1] Active Queue Management section.

#### 6.6.6.4.3.1.39 SfAqmLatencyTarget

This attribute configures the target latency for this service class when operating under Active Queue Management. If set to 0, the value in the AqmGlobalLatencyTarget attribute of the DocsQosCfg object will be used. This attribute applies to both upstream and downstream service flows. This attribute is only used when AqmGlobalEnable in the DocsQosCfg object is set to "true" and the SfAqmEnable attribute is set to "true".

Reference: [MULPIv3.1] Active Queue Management section.

#### 6.6.6.4.3.1.40 DataRateUnitSetting<sup>27</sup>

The default units for the traffic rate parameters (Maximum Sustained Traffic Rate, Minimum Reserved Traffic Rate, and Peak Traffic Rate) within a Service Flow are bits per second (bps). This parameter indicates the base unit for the rates configured using the Maximum Sustained Traffic Rate, Minimum Reserved Traffic Rate, and Peak Traffic Rate. The value of this parameter allows for their interpretation in units of bps, or kbps, or Mbps or Gbps.

#### 6.6.6.4.4 AsfQosProfile

This object describes a provisioned QoS profile for Aggregate Service Flows on a CCAP. Each object instance defines a template for certain Aggregate QoS Parameter Set values. AsfQosProfile for ASF is an equivalent to

---

<sup>27</sup> Text added per CCAP-OSSiv3.0-N-15.1256-1 on 3/2/15 by KB.

Service Class for a Service Flow. The object as defined in this specification contains only one standardized QoS parameter: MaxAggregateTrafficRate. Other aggregate QoS parameters can be added through vendor-specific extensions.

**Table 6-101 - AsfQoSProfile Object Attributes**

Attribute Name	Type	Required Attribute	Type Constraints	Units	Default Value
Name	String	key	1..16		
MaxAggregateTrafficRate	BitRate	No		bps	0
Direction	IfDirection	Yes			

6.6.6.4.4.1 AsfQoSProfile Object Attributes

**6.6.6.4.4.1.1 Name**

This key indicates the ASF QoS Profile Name associated with this object instance. DOCSIS specifies that the maximum size is 16 ASCII characters including a terminating zero. The terminating zero is not represented in this SnmpAdminString syntax attribute.

**6.6.6.4.4.1.2 MaxAggregateTrafficRate**

This attribute is the template for the Maximum Aggregate Traffic Rate attribute for ASFs.

**6.6.6.4.4.1.3 Direction**

This attribute is the template for the Direction attribute of the AsfQoSProfile.

6.6.6.4.5 IatcProfile

This object represents a template for configuration of an Interface Aggregate Traffic Class. An Interface Aggregate Traffic Class (IATC) represents a grouping of one or more Service Flows mapped to a single channel or a bonding group. The IATCs enable the operators to virtually divide the bandwidth of service groups, bonding groups or channels between distinct services or users.

**Table 6-102 - IatcProfile Object Attributes**

Attribute Name	Type	Required Attribute	Type Constraints	Units	Default Value
Name	String	key	1..16		
MaxAggregateTrafficRate	BitRate	No		bps	0
ServiceFlowTrafficPriorityLow	unsignedByte	No			0
ServiceFlowTrafficPriorityHigh	unsignedByte	No			0
Direction	IfDirection	Yes			

**Table 6-103 - IatcProfile Object Associations**

Associated Object Name	Type	Near-end Multiplicity	Far-end Multiplicity	Label
IatcAppld	Directed composition to IatcAppld		0..*	
IatcSCN	Directed composition to IatcSCN		0..*	

6.6.6.4.5.1 IatcProfile Object Attributes

**6.6.6.4.5.1.1 Name**

This key indicates the IATC Profile Name associated with this object instance.

#### 6.6.6.4.5.1.2 MaxAggregateTrafficRate

This attribute is the template for the Maximum Aggregate Traffic Rate attribute for this IATC object instance.

#### 6.6.6.4.5.1.3 ServiceFlowTrafficPriorityLow and ServiceFlowTrafficPriorityHigh (separate, high >= low)

The attributes ServiceFlowTrafficPriorityLow and ServiceFlowTrafficPriorityHigh define a range of Service Flow Traffic Priority values that the CCAP will use to match service flows to the IATC profile.

#### 6.6.6.4.5.1.4 Direction

This attribute is the template for the Direction attribute of the IatcProfile.

#### 6.6.6.4.6 IatcAppld

The IatcAppId object allows for the configuration of a list of one or more application IDs by which Service Flows can be matched to the IATC profile.

**Table 6-104 - IatcAppldObject Attributes**

Attribute Name	Type	Required Attribute	Type Constraints	Units	Default Value
Appld	unsignedInt	Yes (Key)			

#### 6.6.6.4.6.1 IatcAppldObject Attributes

##### 6.6.6.4.6.1.1 AppId

This attribute is the template for the AppId attribute, which represents an Application ID by which Service Flows can be matched to an IATC.

#### 6.6.6.4.7 IatcScn

The IatcScn object allows for the configuration of a list of one or more Service Class Names by which Service Flows can be matched to the IATC profile.

**Table 6-105 - IatcScn Object Attributes**

Attribute Name	Type	Required Attribute	Type Constraints	Units	Default Value
SCN	String	Yes (Key)	1..16		

#### 6.6.6.4.7.1 IatcScn Object Attributes

##### 6.6.6.4.7.1.1 SCN

This attribute is a Service Class Name by which Service Flows can be matched to IATC.

### 6.6.6.5 DOCSIS Multicast QoS Configuration

Multicast configuration includes per multicast session policies to configure QoS and BPI encryption of multicast sessions. This Information Model defines the configuration requirements for multicast session QoS and privacy over the HFC by extending the DOCSIS QoS model [MULPIv3.1] and Baseline Privacy Interface (BPI) [SECv3.1] requirements respectively. The components of the Multicast Configuration model are:

- CmtsGrpCfg, the Multicast Group Configuration rules for Multicast that includes QoS, Encryption and DSID-based Packet Header suppression,
- CmtsGrpQosCfg, the QoS policies for Multicast Sessions,

- DefGrpSvcClass, default SCN template reference for unclassified Multicast sessions,
- CmtsGrpEncryptCfg, encryption rules configuration for Multicast sessions,

The configuration of QoS for Multicast requires that the CMTS supports the CmtsGrpCfg, CmtsGrpQosCfg, GrpSvcClass, and CmtsGrpEncryptCfg objects.

The representation of GSFs for management purposes is similar to unicast service flows. A GSF is a specialization of unicast service flows; therefore, the DOCSIS QoS Model [MULPIv3.1] and the QoS management model from Section 7.2.1.6 applies to GSFs with some considerations:

- GSFs have corresponding Service Flow IDs in the downstream direction. The CMTS represents GSFs in the QoS model from Section 7.2.1.6, in particular, in ServiceFlow, PktClass, ParamSet, ServiceFlowStats, and ServiceFlowLog. GSFs are never signaled to the CM.
- GSFs have no corresponding mapping to CM MAC Addresses as unicast service flows; therefore, CmtsMacToSrvFlow does not contain information related to GSFs. Instead the GrpServiceFlow indicates the SFIDs of GSFs per-MAC domain.
- To complete the classification of the multicast traffic to a GSF, entries in the Group Configuration object are used to build a Group Classifier Rule (GCR) when there is a nonzero value for QosConfigId [MULPIv3.1].

This group of configuration elements allows for the configuration of DOCSIS Multicast QoS. The configuration specific Information Model is shown below.

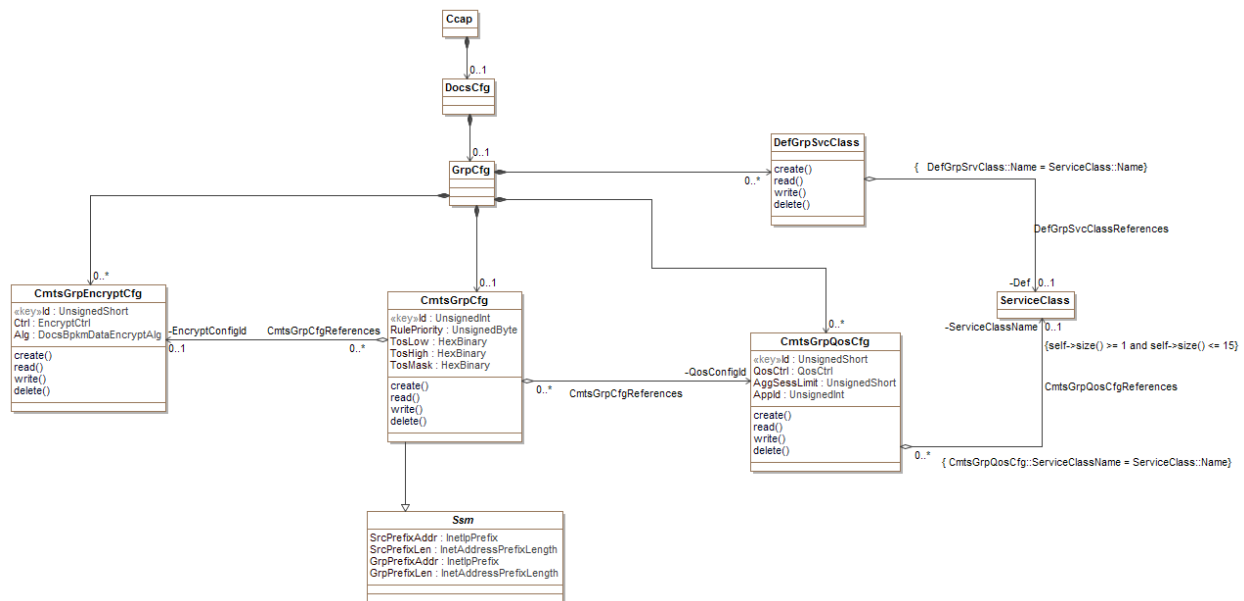

Figure 6-10 - DOCSIS Multicast QoS Configuration Objects

### 6.6.6.5.1 Ccap

This configuration object is included in Figure 6-10 for reference. It is defined in Section 6.6.3.1, Ccap Object.

### 6.6.6.5.2 DocsCfg

This configuration object is included in Figure 6-10 for reference. It is defined in Section 6.6.6.1.2, DocsCfg.

### 6.6.6.5.3 GrpCfg

The GrpCfg object is the primary container of DOCSIS Multicast QoS configuration objects. It has the following associations:

**Table 6-106 - GrpCfg Object Associations**

Associated Object Name	Type	Near-end Multiplicity	Far-end Multiplicity	Label
CmtsGrpCfg	Directed composition to CmtsGrpCfg		0..1	
DefGrpSvcClass	Directed composition to DefGrpSvcClass		0..*	
CmtsGrpQosCfg	Directed composition to CmtsGrpQosCfg		0..*	
CmtsGrpEncryptCfg	Directed composition to CmtsGrpEncryptCfg		0..*	

#### 6.6.6.5.4 CmtsGrpCfg

This object controls the QoS and encryption settings for downstream forwarding of IP multicast sessions. An IP multicast session is replicated to one or more Downstream Channel Sets (DCSs), where each DCS is either a single downstream channel or a downstream bonding group of multiple channels. The CCAP determines on which DCSs to replicate a multicast session based on IP multicast membership reports ("joins") or other vendor-specific static configuration.

The CmtsGrpCfg object allows for the configuration of a range of sessions through the SrcPrefixAddr, GrpPrefixAddr, SrcPrefixLen, and GrpPrefixLen attributes, which are inherited from the Ssm object (defined in Section 6.6.6.7.7).

Cable operators can specify configuration rules for a range of multicast sessions through the tuples of (SrcPrefixAddr, SrcPrefixLen, GrpPrefixAddr, GrpPrefixLen) attributes in an entry. The QosConfigId association identifies the QoS rule, and the EncryptConfigId association identifies the encryption rule for a particular entry. Even if an entry indicates a range of multicast sessions, the Encryption rules are applied on a per-session basis. Thus, when an Operator configures Encryption for a given Group Config entry, each session has those rules applied on a per session and per replication basis. Group Encryption rules are indicated by using a non-zero value for the EncryptCfgId.

The QosCtrl attribute from the CmtsGrpQosCfg object is used to determine if the traffic for a range of multicast sessions identified by an entry in the CmtsGrpCfg object will be transmitted in an "Aggregate-Session" Group Service Flow (GSF) or will be transmitted separately for each session using "Single-Session" GSFs. Even if the range of multicast sessions are transmitted on an "Aggregate-Session" GSF, the Encryption rules are always applied individually to a multicast session on a per-session DSID basis prior to being transmitted on an "Aggregate-Session" GSF.

This object supports the creation and deletion of multiple instances.

Creation of a new instance of this object requires the following attributes to be set.

- RulePriority
- SrcPrefixAddr (inherited from the Ssm abstract object)
- SrcPrefixLen (inherited from the Ssm abstract object)
- GrpPrefixAddr (inherited from the Ssm abstract object)
- GrpPrefixLen (inherited from the Ssm abstract object)
- TosLow
- TosHigh
- TosMask

The CMTS and CCAP MUST persist all instances of the CmtsGrpCfg object across system reinitializations.

**Table 6-107 - CmtsGrpCfg Object Attributes**

Attribute Name	Type	Required Attribute	Type Constraints	Units	Default Value
Id	UnsignedInt	key	1..4294967295		
RulePriority	UnsignedByte	Yes	0..63   192..255		
TosLow	HexBinary	Yes	SIZE (1)		
TosHigh	HexBinary	Yes	SIZE (1)		
TosMask	HexBinary	Yes	SIZE (1)		

**Table 6-108 - CmtsGrpCfg Object Associations**

Associated Object Name	Type	Near-end Multiplicity	Far-end Multiplicity	Label
CmtsGrpQosCfg	Directed aggregation to CmtsGrpQosCfg	0..*		QosConfigId *
CmtsGrpEncryptCfg	Directed aggregation to CmtsGrpEncryptCfg	0..*	0..1	EncryptConfigId
Ssm	Specialization of Ssm			

\* If no QosConfigId association is specified, all replications referenced by this CmtsGrpCfg instance will be forwarded to the default GSF. If no EncryptCfgId association is specified, no encryption will be applied to all replications derived from this GC.

**6.6.6.5.4.1 CmtsGrpCfg Object Attributes**

**6.6.6.5.4.1.1 Id**

This attribute is the key that identifies unique instances of the CmtsGrpCfg Object.

**6.6.6.5.4.1.2 RulePriority**

This attribute indicates the priority of this entry used to resolve which instance of this object apply when a newly replicated multicast session matches multiple entries. Higher values indicate a higher priority. Valid values for this attribute are 0..63 and 192..255 in order to not conflict with CMTS internally-created instances that use the range 64..191.

**6.6.6.5.4.1.3 TosLow**

This attribute identifies the low value of a range of the ToS byte value to be defined in a packet classifier this GC instantiates in the GCR in order to limit the GCR-matched traffic to a particular set of DSCPs. This applies to the IPv4 ToS byte and the IPv6 Traffic Class byte.

The IP ToS octet, as originally defined in [RFC 791], has been superseded by the 6-bit Differentiated Services Field (DSField, [RFC 3260]) and the 2-bit Explicit Congestion Notification Field (ECN field, [RFC 3168]).

References: [RFC 791]; [RFC 3260]; [RFC 3168].

**6.6.6.5.4.1.4 TosHigh**

This attribute identifies the high value of a range of the ToS byte value to be defined in a packet classifier this GC instantiates in the GCR in order to limit the GCR-matched traffic to a particular set of DSCPs. This applies to the IPv4 ToS byte and the IPv6 Traffic Class byte.

The IP ToS octet, as originally defined in [RFC 791], has been superseded by the 6-bit Differentiated Services Field (DSField, [RFC 3260]) and the 2-bit Explicit Congestion Notification Field (ECN field, [RFC 3168]).

References: [RFC 791]; [RFC 3260]; [RFC 3168].



#### 6.6.6.5.4.1.5 TosMask

This attribute identifies the mask value bitwise ANDed with a ToS byte value to be defined in a packet classifier this GC instantiates in the GCR in order to limit the GCR-matched traffic to a particular set of DSCPs. This applies to the IPv4 ToS byte and the IPv6 Traffic Class byte.

The IP ToS octet, as originally defined in [RFC 791], has been superseded by the 6-bit Differentiated Services Field (DSField, [RFC 3260]) and the 2-bit Explicit Congestion Notification Field (ECN field, [RFC 3168]).

References: [RFC 791]; [RFC 3260]; [RFC 3168].

#### 6.6.6.5.5 Ssm

This configuration object is included in Figure 6-10 for reference. It is defined in Section 6.6.6.7.7, Ssm.

#### 6.6.6.5.6 CmtsGrpEncryptCfg

This object controls the configuration of the Security Association (SA) and the encryption algorithm used for multicast sessions.

This object supports the creation and deletion of instances.

The CMTS and CCAP MUST persist all instances of the CmtsGrpEncryptCfg object across system reinitializations.

**Table 6-109 - CmtsGrpEncryptCfg Object Attributes**

Attribute Name	Type	Required Attribute	Type Constraints	Units	Default Value
Id	unsignedShort	key			
Ctrl	Enum	No	other(1), cmts(2), mgmt(3)		mgmt
Alg	Enum	No	other(1), des56CbcMode(2), des40CbcMode(3), aes128CbcMode(4)		des56CbcMode

#### 6.6.6.5.6.1 CmtsGrpEncryptCfg Object Attributes

##### 6.6.6.5.6.1.1 Id

This attribute specifies the unique identifier of instances of this object.

##### 6.6.6.5.6.1.2 Ctrl

This attribute controls whether the CMTS can select the encryption algorithm or if this can be set manually using the Alg attribute. If this attribute is set to 'cmts', the CMTS can select the encryption algorithm for the Security Association (SA). If this attribute is set to 'mgmt', the Alg attribute is used to define the encryption algorithm for this SA. If this attribute is set to 'other', a vendor extension is in use.

##### 6.6.6.5.6.1.3 Alg

This attribute defines which encryption algorithm will be used for an SA referenced by this object when the Ctrl is set to 'mgmt'. If this attribute is set to 'other', a vendor extension is in use.

#### 6.6.6.5.7 CmtsGrpQosCfg

This object configures the QoS for Multicast sessions replicated to any Downstream Channel Set (DCS). It does not control to which particular DCSs the CCAP replicates a multicast session.

An instance of this object is called a GQC entry. A GQC entry controls how the CCAP instantiates a Group Classifier Rule (GCR) on the DCS to match packets of the multicast session. A GCR uses source and destination IP address and ToS criteria.

A GQC entry controls how and with what QoS parameters a GSF is created on a DCS. All downstream multicast packets are scheduled on a GSF. The QoS Type attribute of the GQC entry controls whether the CCAP creates one GSF for each single IP multicast session or whether the CCAP creates one GSF for the aggregate of all sessions that match the GQC criteria. The GQC instance contains a reference to a Service Class Name QoS Parameter Set template. The Service Class defines the list of QoS parameters for the GSF(s) instantiated for the GQC entry.

A CCAP identifies one Service Class as the Default Group QoS Service Class. The CCAP instantiates a Default GSF on each single-channel DCS based on the parameters of the Default Group QoS Service Class.

The set of GCRs and GSFs instantiated on a DCS control how QoS is provided to multicast packets replicated to the DCS. For each multicast packet, the CCAP classifies the packet to the highest priority matching GCR on that DCS. The GCR refers to a single GSF, which controls the scheduling of the packets on the DCS. If the multicast packet does not match any GCR on the DCS, the packet is scheduled on the Default GSF of the DCS. The CCAP replicates unclassified multicast traffic to only DCSs consisting of a single downstream channel. Thus, the Maximum Sustained Traffic Rate QoS parameter of the Default Group Service Class limits the aggregate rate of unclassified multicast traffic on each downstream channel.

The CCAP is expected to instantiate GCRs and GSFs controlled by the entries in this table only for the duration of replication of the multicast sessions matching the entry.

This object supports the creation of multiple instances.

Creation of new instances of this object require the following objects to be set:

- ServiceClassName
- QosCtrl
- AggSessLimit

The CMTS and CCAP MUST persist all instances of the CmtsGrpQosCfg object across system reinitialization.

**Table 6-110 - CmtsGrpQosCfg Object Attributes**

Attribute Name	Type	Required Attribute	Type Constraints	Units	Default Value
Id	unsignedShort	key			
QosCtrl	Enum	Yes	other(1), singleSession(2), aggregateSession(3)		
AggSessLimit	UnsignedShort	Yes	1.. 65535	sessions	
Appld	UnsignedInt	Yes			0

**Table 6-111 - CmtsGrpQosCfg Object Associations**

Associated Object Name	Type	Near-end Multiplicity	Far-end Multiplicity	Label
ServiceClass	Directed aggregation to ServiceClass	0..*	0..1	ServiceClassName

6.6.6.5.7.1 CmtsGrpQosCfg Object Attributes

**6.6.6.5.7.1.1 Id**

This attribute identifies a unique Group QoS Configuration object instance.

**6.6.6.5.7.1.2 QosCtrl**

This attribute identifies how Group Classifier Rules (GCRs) and Group Service Flows (GSFs) are instantiated when multiple sessions match the (S,G) criteria of this entry. If 'singleSession', the CMTS creates a unique GCR and a

unique GSF for the session. If this object's value is 'aggregateSession', all sessions matching this criterion are aggregated into the same GSF. If this attribute is set to 'other', a vendor extension is in use.

#### 6.6.6.5.7.1.3 AggSessLimit

This attribute identifies the maximum number of sessions that may be aggregated in an aggregated Service Flow. This value is ignored in case of a GQC entry with QosCtrl set to 'singleSession'.

#### 6.6.6.5.7.1.4 AppId

This attribute allows the operator to configure a Cable Operator defined Application Identifier for multicast sessions, e.g., an Application Manager ID and Application Type. This Application Identifier can be used to influence admission control or other policies in the CMTS that are outside of the scope of this specification. This parameter is optional in defining QoS for multicast sessions.

If the value of this attribute is different from the value of the AppId in the referenced SCN for this GQC instance, the value of this attribute is used.

References: [MULPIv3.1] Application Identifier section in the Common Radio Frequency Interface Encodings Annex; [PCMM] Policy Server and CMTS Interface section.

#### 6.6.6.5.8 ServiceClass

This configuration object is included in Figure 6-10 for reference. It is defined in Section 6.6.6.4.3, ServiceClass.

#### 6.6.6.5.9 DefGrpSvcClass

This object provides a reference to the Default Group Service Class. The CCAP instantiates a Default GSF with the QoS param Set indicated by this Service Class Name reference on every Downstream Channel Set to which it replicates multicast packets that are otherwise unclassified by a Group Classifier Rule.

The CMTS and CCAP MUST persist the value of the attributes of the DefGrpSvcClass object across reinitializations.

**Table 6-112 - DefGrpSvcClass Object Associations**

Associated Object Name	Type	Near-end Multiplicity	Far-end Multiplicity	Label
ServiceClass	Directed aggregation to ServiceClass		0..1	DefGrpSvcClass::Name = ServiceClass::Name

### 6.6.6.6 MAC Domain Configuration

The Information Model for MAC Domain configuration is shown below.

The HFC RF combining and splitting topology between a CMTS and Cable Modems results in distinct sets of CMs called Cable Modem Service Groups (CM-SGs) that are served by distinct combinations (i.e., non-overlapping subsets) of Downstream Channels and Upstream Channels. Because a MAC Domain defines a separate number space for many DOCSIS protocol elements (e.g., DSIDs, SAIDs, etc.), an operator should define separate MAC Domains that serve disjoint subsets of CM-SGs rather than a single MAC Domain for all CM-SGs.

A Downstream Bonding Group (DBG) is a set of Downstream Channels (DCs) on which the CMTS distributes packets. The CMTS enforces that all Downstream Channels of a DBG are contained within the same MAC Domain Downstream Service Group (MD-DS-SG). A CMTS permits configuration of a Downstream Channel as a member of multiple DBGs. A CMTS can restrict the assignment of Downstream Channels to DBGs based on vendor product implementation. For example, a CMTS product implementation may restrict the set of Downstream Channels that could be bonded to a given Bonded Channel Set to a subset of the downstream channels in the MAC Domain.

An Upstream Bonding Group (UBG) is a set of Upstream Channels (UCs) on which upstream data forwarding service may be provided to a single CM. The CCAP MUST reject a configuration where the Upstream Channels in

an Upstream Bonding Group are not contained within the same MAC Domain Upstream Service Group (MD-US-SG). A CMTS permits configuration of an Upstream Channel as a member of multiple UBGs. A CMTS can restrict the assignment of Upstream Channels to UBGs based on vendor product implementation. For example, a CMTS product implementation could restrict the set of Upstream Channels that could be bonded to a subset of the downstream channels in the MAC Domain.

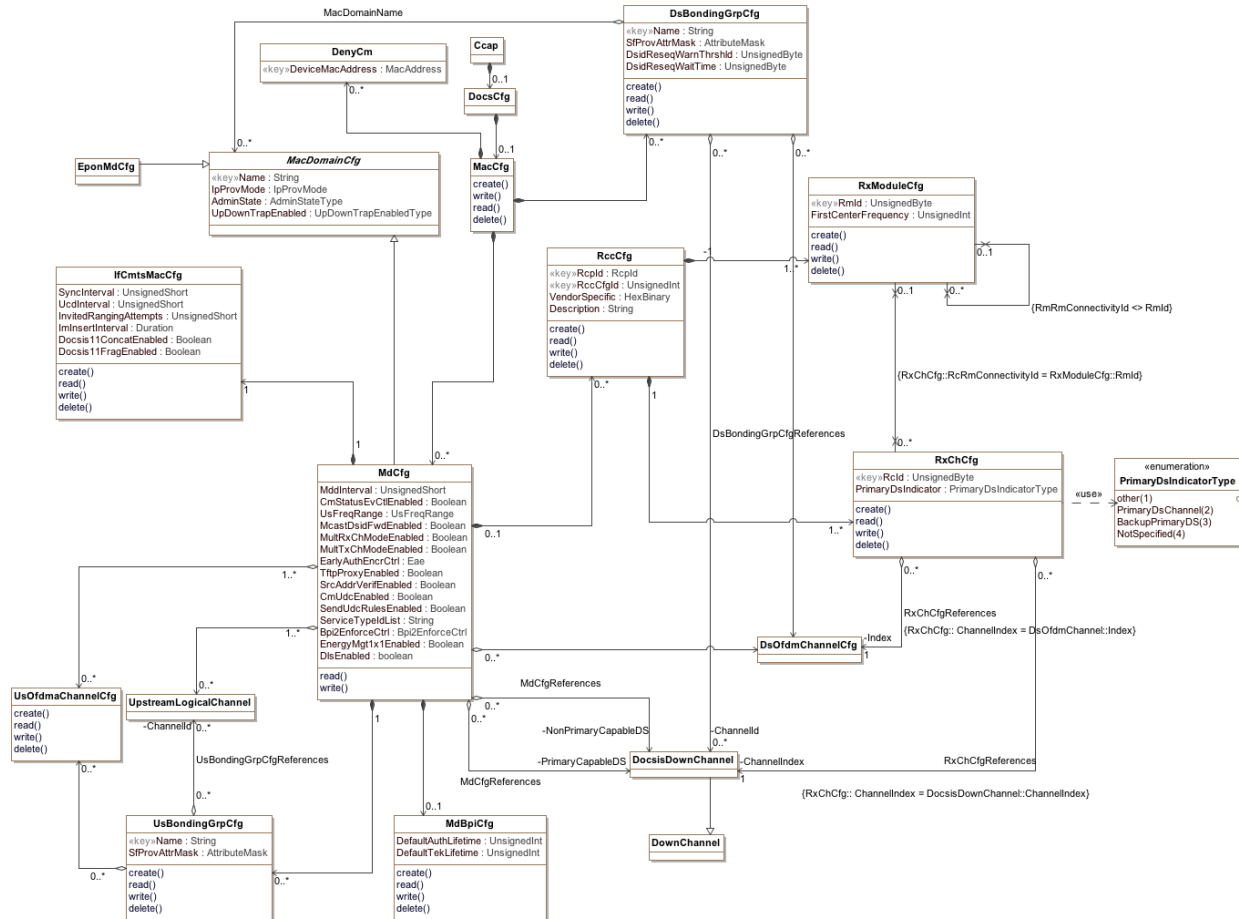

Figure 6-11 - MAC Domain Configuration Objects<sup>28</sup>

6.6.6.6.1 Ccap

This configuration object is included in Figure 6-11 for reference. It is defined in Section 6.6.3.1, Ccap Object.

6.6.6.6.2 DocsCfg

This configuration object is included in Figure 6-11 for reference. It is defined in Section 6.6.6.1.2, DocsCfg.

6.6.6.6.3 MacCfg

The MacCfg object is the container for DOCSIS MAC Domain configuration objects. It has the following associations:

<sup>28</sup> Modified per CCAP-OSSlv3.1-N-16.1571-1 on 11/16/16 by KB.

**Table 6-113 - MacCfg Object Associations**

Associated Object Name	Type	Near-end Multiplicity	Far-end Multiplicity	Label
MdCfg	Directed composition to MdCfg		0..*	
DsBondingGrpCfg	Directed composition to DsBondingGrpCfg		0..*	
DenyCm	Directed composition to DenyCm		0..*	

#### 6.6.6.6.4 MdCfg

This object contains MAC domain level control and configuration attributes.

A MAC Domain corresponds to exactly one instance of a DocsCableMacLayer interface (ifType of 127) in the ifTable. In the configuration model, MdCfg is identified with a Name that is unique within the CCAP, inherited from the MacDomainCfg abstract object. For the ifTable, the CCAP implementation selects a value of the ifIndex for the DocsCableMacLayer index. The DocsCableMacLayer ifIndex is used extensively in several reporting objects as an index for several reporting objects. The CcapInterfaceIndexMapTable, defined in Section 7.2.1.10, maps a DocsCableMacLayer ifIndex to a configured MdCfg instance.

Some CCAP implementations may implement the association of non-primary capable downstream channels with MAC Domain indirectly, based on RF plant topology configuration.

The CMTS and CCAP MUST persist all instances of MdCfg across reinitializations.

**Table 6-114 - MdCfg Object Attributes<sup>29</sup>**

Attribute Name	Type	Required Attribute	Type Constraints	Units	Default Value
MddInterval	Unsigned Short	No	1..2000	milliseconds	2000
CmStatusEvCtlEnabled	Boolean	No			true
UsFreqRange	Enum	No	other(1), standard(2), extended(3)		standard
McastDsidFwdEnabled	Boolean	No			true
MultRxChModeEnabled	Boolean	No			true
MultTxChModeEnabled	Boolean	No			true
EarlyAuthEncryptCtrl	Enum	No	other(1), disableEae(2), enableEaeRangingBasedEnforcement(3), enableEaeCapabilityBasedEnforcement(4), enableEaeTotalEnforcement(5)		enableEaeRangingBasedEnforcement
TftpProxyEnabled	Boolean	No			true
SrcAddrVerifEnabled	Boolean	No			true
CmUdcEnabled	Boolean	No			false
SendUdcRulesEnabled	Boolean	No			false
ServiceTypeIdList	TagList	No	SIZE (0..256)		"H
Bpi2EnforceCtrl	Enum	No	other(1), disable(2), qosCfgFileWithBpi2AndCapabPrivSupportEnabled(3), qosCfgFileWithBpi2Enabled(4), qosCfgFile(5), total(6)		qosCfgFileWithBpi2Enabled
EnergyMgt1x1Enabled	Boolean	No			false
DlsEnabled	Boolean	No			true

<sup>29</sup> Modified per CCAP-OSSiv3.1-N-16.1571-1 on 11/16/16 by KB.

**Table 6-115 - MdCfg Object Associations**

Associated Object Name	Type	Near-end Multiplicity	Far-end Multiplicity	Label
MacDomainCfg	Specialization of MacDomainCfg			
IfCmtsMacCfg	Directed composition to IfCmtsMacCfg	1	1	
UpstreamLogicalChannel	Directed aggregation to UpstreamLogicalChannel	1	0..*	
UsBondingGrpCfg	Directed composition to UsBondingGrpCfg	1	0..*	
DocsisDownChannel	Directed aggregation to DocsisDownChannel	0..1		PrimaryCapableDs
DocsisDownChannel	Directed aggregation to DocsisDownChannel	0..*		NonPrimaryCapableDs
RccCfg	Directed composition to RccCfg	0..1	0..*	
MdBpiCfg	Directed composition to MdBpiCfg		0..1	
UsOfdmaChannel	Directed aggregation to UsOfdmaChannel	1	0..*	
DsOfdmChannelCfg	Directed aggregation to DsOfdmChannelCfg	0..*		

#### 6.6.6.4.1 MdCfg Object Attributes<sup>30</sup>

##### 6.6.6.4.1.1 MddInterval

This attribute configures the interval for the insertion of MDD messages in each downstream channel of a MAC Domain.

References: [MULPIv3.1] Parameters and Constants Annex.

##### 6.6.6.4.1.2 CmStatusEvCtlEnabled

If set to 'true', this attribute enables the signaling of the CM-Status Event reporting mechanism.

References: [MULPIv3.1] CM-STATUS Event Control section.

##### 6.6.6.4.1.3 UsFreqRange

This attribute indicates in MDD messages the upstream frequency upper band edge of an upstream Channel.

A value 'standard' means Standard Frequency Range and a value 'extended' means Extended Frequency Range.

A value 'other' indicates a vendor extension is in use.

References: [MULPIv3.1] Upstream Frequency Range TLV section.

##### 6.6.6.4.1.4 McastDsidFwdEnabled

If set to 'true', this attribute enables the CMTS to use IP Multicast DSID Forwarding (MDF) for the MAC domain.

References: [MULPIv3.1] Multicast DSID-based Forwarding (MDF) Modes section in the Compatibility with Previous Versions of DOCSIS Annex.

##### 6.6.6.4.1.5 MultRxChModeEnabled

If set to 'true', this attribute enables Downstream Channel Bonding for the MAC Domain.

References: [MULPIv3.1] Downstream Channel Bonding section.

##### 6.6.6.4.1.6 MultTxChModeEnabled

If set to 'true', this attribute enables Multiple Transmit Channel (MTC) Mode for the MAC Domain.

<sup>30</sup> Modified per CCAP-OSSv3.1-N-16.1571-1 on 11/16/16 by KB.

References: [MULPIv3.1] Upstream Channel Bonding section.

#### **6.6.6.4.1.7 EarlyAuthEncryptCtrl**

This attribute enables or disables early authentication and encryption (EAE) signaling for the MAC Domain. It also defines the type of EAE enforcement in the case that EAE is enabled.

If set to 'disableEAE', EAE is disabled for the MAC Domain.

If set to 'enableEaeRangingBasedEnforcement', 'enableEaeCapabilityBasedEnforcement' or 'enableEaeTotalEnforcement', EAE is enabled for the MAC Domain.

The following EAE enforcement methods are defined in the case where EAE signaling is enabled:

- The option 'enableEaeRangingBasedEnforcement' indicates EAE is enforced on CMs that perform ranging with a B-INIT-RNG-REQ message.
- The option 'enableEaeCapabilityBasedEnforcement' indicates EAE is enforced on CMs that perform ranging with a B-INIT-RNG-REQ message in which the EAE capability flag is set.

The option 'enableEaeTotalEnforcement' indicates EAE is enforced on all CMs regardless of their EAE capabilities.

A value 'other' indicates a vendor extension is in use.

References: [SECV3.1] Early Authentication and Encryption section.

#### **6.6.6.4.1.8 TftpProxyEnabled**

If set to 'true', this attribute enables TFTP Proxy functionality for the MAC Domain.

References: [SECV3.1] TFTP Configuration File Security section.

#### **6.6.6.4.1.9 SrcAddrVerifiEnabled**

If set to 'true', this attribute enables Source Address Verification (SAV) functionality for the MAC Domain.

References: [SECV3.1] Source Address Verification section.

#### **6.6.6.4.1.10 CmUdcEnabled**

If set to 'true', this attribute instructs the CMTS MAC Domain to enable Upstream Drop Classifiers (UDC) for the CMs attempting registration in this MAC Domain.

References: [MULPIv3.1], Upstream Drop Classifiers section

#### **6.6.6.4.1.11 SendUdcRulesEnabled**

If set to 'true' and when the CM signals to the CMTS 'Upstream Drop Classifier Group ID' encodings, this attribute instructs the CMTS MAC Domain to send the Subscriber Management Filters rules associated with the 'Upstream Drop Classifier Group ID' encodings to the CM in the form of UDCs when the following conditions occurs:

- The attribute CmUdcEnabled value for this MAC Domain is set to 'true', and
- The CM has the UDC capability advertised as supported.

If there is no a single Subscriber Management Filter configured in the CMTS for the CM's signaled UDC Group ID, the CMTS does not send UDC encodings to the CM.

It is vendor specific whether the CMTS maintains enforcement of the CM signaled or default Subscriber Management Filter groups in the upstream direction.

References: [MULPIv3.1], Upstream Drop Classifiers section

#### **6.6.6.4.1.12 ServiceTypeIdList**

This attribute indicates the list of Service Type IDs associated with the MAC Domain.

During the CM registration process the CMTS will attempt to redirect the CM to a MAC Domain where the CM' Service Type TLV is contained in this attribute.

References: [MULPIv3.1], Service Type Identifier section in the Common Radio Frequency Interface Encodings Annex.

#### **6.6.6.4.1.13 Bpi2EnforceCtrl<sup>31</sup>**

This attribute indicates the level of BPI+ enforcement policies with the MAC Domain.

The following BPI+ enforcement policies are defined in the case where BPI+ is enabled:

- The option 'disable' indicates that CMTS does not enforce BPI+.
- The option 'qosCfgFileWithBpi2AndCapabPrivSupportEnabled' indicates the CMTS enforces BPI+ on CMs that register with parameters indicating BPI+ is enabled (missing TLV 29 or containing TLV 29 set to enable) and with a Modem Capabilities Privacy Support TLV (5.6) set to BPI+ support.
- The option 'qosCfgFileWithBpi2Enabled' indicates the CMTS enforces BPI+ on CMs that register with parameters indicating BPI+ is enabled (missing TLV 29 or containing TLV 29 set to enable).
- The option 'qosCfgFile' indicates the CMTS enforces BPI+ on CMs that register with a DOCSIS 1.1 style configuration file. Because DOCSIS 3.1 devices will only register with a DOCSIS 1.1 style configuration file, the 'qosCfgFile' is the same as the 'total' option in DOCSIS 3.1.
- The option 'total' indicates the CMTS enforces BPI+ on all CMs.
- A value 'other' indicates a vendor extension is in use.

References: [SECV3.1] BPI+ Enforce section.

#### **6.6.6.4.1.14 EnergyMgt1x1Enabled**

This attribute indicates whether the CMTS is configured for 1x1 Energy Management Mode of operation on a per MAC Domain basis.

If this attribute is set to 'true', the CMTS is configured for 1x1 Energy Management Mode of operation on this MAC Domain. If this attribute is set to 'false', the Energy Management 1x1 Mode of operation is disabled in the CMTS on this MAC Domain.

References: [MULPIv3.1], Energy Management Capabilities section.

#### **6.6.6.4.1.15 DlsEnabled**

This attribute indicates whether the CMTS is configured for DOCSIS Light Sleep (DLS) Mode of operation on a per MAC Domain basis. If this attribute is set to 'true', the CMTS is configured for DLS Mode of operation on this MAC Domain. If this attribute is set to 'false', the DLS Mode of operation is disabled in the CMTS on this MAC Domain. References: [MULPIv3.1], DOCSIS Light Sleep (DLS) Feature.

#### **6.6.6.5 MdBpiCfg**

This object is based on the DocsBpiCmtsBaseEntry table defined in [RFC 3083].

This optional object provides the configuration of the Baseline Privacy key lifetimes for the MAC domain. If not used, the CCAP uses the defaults defined in SysBpiCfg.

Reference: [RFC 3083]

---

<sup>31</sup> Modified per CCAP-OSSv3.1-N-16.1640-2 on 11/18/16 by KB.



**Table 6-116 - MdBpiCfg Object Attributes**

Attribute Name	Type	Required Attribute	Type Constraints	Units	Default
DefaultAuthLifetime	UnsignedInt	Yes	1..6048000	Seconds	
DefaultTEKLifetime	UnsignedInt	Yes	1..6048000	Seconds	

#### 6.6.6.6.5.1 MacDomainCfg Object Attributes

##### 6.6.6.6.5.1.1 DefaultAuthLifetime

The value of this object is the default lifetime, in seconds, the CCAP assigns to a new authorization key.

##### 6.6.6.6.5.1.2 DefaultTEKLifetime

The value of this object is the default lifetime, in seconds, the CCAP assigns to a new Traffic Encryption Key (TEK).

#### 6.6.6.6.6 MacDomainCfg

The MacDomainCfg abstract object contains the MAC domain attributes used by DOCSIS and EPON MAC domains.

**Table 6-117 - MacDomainCfg Object Attributes**

Attribute Name	Type	Required Attribute	Type Constraints	Units	Default Value
Name	String	Yes (Key)			
IpProvMode	Enum	Yes	other(1), ipv4Only(2), ipv6Only(3), alternate(4), dualStack(5)		
AdminState	AdminState	No			down
UpDownTrapEnabled	UpDownTrapEnabled	No			true

#### 6.6.6.6.6.1 MacDomainCfg Object Attributes

##### 6.6.6.6.6.1.1 Name

The name of the MacDomain.

##### 6.6.6.6.6.1.2 IpProvMode

This attribute configures the IP provisioning mode for a MAC Domain.

When this attribute is set to 'ipv4Only' the CM will acquire a single IPv4 address for the CM management stack.

When this attribute is set to 'ipv6Only' the CM will acquire a single IPv6 address for the CM management stack.

When this attribute is set to 'alternate' the CM will acquire a single IPv6 address for the CM management stack and, if failures occur, the CM will fall back to provisioning and operation with an IPv4 address.

When this attribute is set to 'dualStack' the CM will acquire both an IPv6 and IPv4 address for provisioning and operation.

When this attribute is set to 'other' the CM will acquire an IP address using a vendor-specific method.

References: [MULPIv3.1] IP Initialization Parameters TLV section.

**6.6.6.6.1.3 AdminState**

This attribute configures the administrative state of the MAC Domain.

**6.6.6.6.1.4 UpDownTrapEnabled**

This attribute configures whether linkUp/linkDown traps are enabled for this MAC Domain.

**6.6.6.6.7 EponMdCfg**

This configuration object is included in Figure 6-11 for reference. It is defined in Section 6.6.10.6, EponMdCfg.

**6.6.6.6.8 IfCmtsMacCfg**

This object is based on the docsIfCmtsMacTable defined in [RFC 4546]. The following modifications have been made:

- The following attributes have been removed:
  - ifIndex
  - docsIfCmtsMacCapabilities
  - docsIfCmtsMacMaxServiceIds
  - docsIfCmtsMacStorageType
- The SyncInterval attribute (docsIfCmtsSyncInterval) data type has been shortened to UnsignedShort.
- The following attributes have been added to the IfCmtsMacCfg object, and are defined here:
  - Docsis11ConcatEnabled
  - Docsis11FragEnabled

Reference: [RFC 4546], docsIfCmtsMacTable

**Table 6-118 - IfCmtsMacCfg Object Attributes**

Attribute Name	Type	Required Attribute	Type Constraints	Units	Default Value
Docsis11ConcatEnabled	Boolean	No			true
Docsis11FragEnabled	Boolean	No			true
SyncInterval	UnsignedShort	Yes		ms	
UcdInterval	UnsignedShort	Yes		ms	
InvitedRangingAttempts	UnsignedShort	Yes		Attempts	
ImInsertInterval	Duration	Yes		Hundreds of seconds	

**6.6.6.6.8.1 IfCmtsMacCfg Object Attributes**

**6.6.6.6.8.1.1 Docsis11ConcatEnabled**

Enables and disables DOCSIS 1.1 concatenation.

**6.6.6.6.8.1.2 Docsis11FragEnabled**

Enables and disables DOCSIS 1.1 fragmentation.

**6.6.6.6.8.1.3 SyncInterval**

The interval between CMTS transmission of successive SYNC messages at this interface.

#### 6.6.6.8.1.4 UcdInterval

The interval between CMTS transmission of successive Upstream Channel Descriptor messages for each upstream channel at this interface.

#### 6.6.6.8.1.5 InvitedRangingAttempts

The maximum number of attempts to make on invitations for ranging requests. A value of zero means the CM will attempt to range forever.

#### 6.6.6.8.1.6 ImInsertInterval

The amount of time to elapse between each broadcast initial maintenance grant. Broadcast initial maintenance grants are used to allow new cable modems to join the network. Zero indicates that a vendor-specific algorithm is used instead of a fixed time. The maximum amount of time permitted by the specification is 2 seconds.

#### 6.6.6.6.9 DocsisDownChannel

This configuration object is included in Figure 6-11 for reference. It is defined in Section 6.6.6.9.2, DocsisDownChannel.

#### 6.6.6.6.10 DownChannel

This configuration object is included in Figure 6-11 for reference. It is defined in Section 6.6.6.9.1, DownChannel.

#### 6.6.6.6.11 DsBondingGrpCfg

The DsBondingGrpCfg object allows for the static creation of Downstream bonding groups. In some current DOCSIS 3.0 configurations, downstream channels are not tied directly to a specific MAC domain, while in others these downstream channels are an integral part of the MAC domain. For CCAP flexibility, the statically-configured bonding group may be optionally explicitly associated with one or multiple MAC domains.

To configure a downstream bonding group, an instance of the DsBondingGrpCfg object is created. The attributes of the DsBondingGrpCfg are shown below. This table has been modified from the definition in OSSiv3.0.

**Table 6-119 - DsBondingGrpCfg Object Attributes**

Attribute Name	Type	Required Attribute	Type Constraints	Units	Default Value
Name	String	Yes (Key)			
SfProvAttrMask	AttributeMask	No			bonded
DsidReseqWarnThrsld	unsignedByte	No	0..179   255	hundredMicroseconds	255
DsidReseqWaitTime	unsignedByte	No	1..180   255	hundredMicroseconds	255

**Table 6-120 - DsBondingGrpCfg Object Associations**

Associated Object Name	Type	Near-end Multiplicity	Far-end Multiplicity	Label
DocsisDownChannel	Directed aggregation to DocsisDownChannel	0..*	0..*	ChannelId
MacDomainCfg	Directed aggregation to MacDomainCfg		0..*	MacDomainName
DsOfdmChannelCfg	Directed aggregation to DsOfdmChannelCfg	0..*		DsBondingGrpCfgReferences

#### 6.6.6.6.11.1 DsBondingGrpCfg Object Attributes

##### 6.6.6.6.11.1.1 Name

The name of the downstream bonding group. This attribute is used as a key.

**6.6.6.11.1.2 SfProvAttrMask**

This attribute represents the Provisioned Attribute Mask encoding for the bonding group.

**6.6.6.11.1.3 DsidReseqWarnThrshld**

This attribute provides the DSID Resequencing Warning Threshold in hundreds of microseconds that is to be used for all DSIDs associated with this Downstream Bonding Group. The value of 255 indicates that the DSID Resequencing Warning Threshold is determined by the CMTS. The value of 0 indicates that the threshold warnings are disabled.

When the value of DsidReseqWaitTime is not equal to 0 or 255, the CCAP will ensure that the value of this object is either 255 or less than the value of DsidReseqWaitTime.

**6.6.6.11.1.4 DsidReseqWaitTime**

This attribute provides the DSID Resequencing Wait Time in hundreds of microseconds that is to be used for all DSIDs associated with this Downstream Bonding Group. The value of 255 indicates that the DSID Resequencing Wait Time is determined by the CMTS.

**6.6.6.12 UsBondingGrpCfg**

The UsBondingGrpCfg object allows for the static creation of upstream bonding groups. To configure an upstream bonding group, an instance of the UsBondingGrpCfg object is created. The attributes of the UsBondingGrpCfg are shown below.

**Table 6-121 - UsBondingGrpCfg Object Attributes**

Attribute Name	Type	Required Attribute	Type Constraints	Units	Default Value
Name	String	Yes (Key)			
SfProvAttrMask	AttributeMask	No			bonded

**Table 6-122 - UsBondingGrpCfg Object Associations**

Associated Object Name	Type	Near-end Multiplicity	Far-end Multiplicity	Label
UpstreamLogicalChannel	Directed aggregation to UpstreamLogicalChannel	0..*	0..*	ChannelId
UsOfdmaChannel	Directed aggregation to UsOfdmaChannel	0..*	0..*	

**6.6.6.12.1 UsBondingGrpCfg Object Attributes**

**6.6.6.12.1.1 Name**

The name of the upstream bonding group. This attribute is used as a key.

**6.6.6.12.1.2 SfProvAttrMask**

This attribute represents the Provisioned Attribute Mask encoding for the bonding group.

**6.6.6.13 UpstreamLogicalChannel**

This configuration object is included in Figure 6-11 for reference. It is defined in Section 6.6.6.8.7, UpstreamLogicalChannel.

**6.6.6.14 RccCfg**

This section defines the CCAP Receive Channel Configuration (RCC) Configuration objects.

This object creates static Receive Channel Configurations for specific downstream channel configurations, identifies the scope of the Receive Channel Configuration (RCC), and provides a top level container for the Receive Module and Receive Channel objects. The CCAP selects an instance of this object to assign to a CM when it registers.

This object supports the creation and deletion of multiple instances.

The CMTS and CCAP MUST persist all instances of RccCfg across reinitializations.

**Table 6-123 - RccCfg Object Attributes**

Attribute Name	Type	Required Attribute	Type Constraints	Units	Default
RcpId	RcpId	key			
RccCfgId	UnsignedInt	key	1..4294967295		
VendorSpecific	HexBinary	No	0..252		"H"
Description	String	No	0..15		""

**Table 6-124 - RccCfg Object Associations**

Associated Object Name	Type	Near-end Multiplicity	Far-end Multiplicity	Label
RxModuleCfg	Directed composition to RxModuleCfg	1	1..*	
RxChCfg	Directed composition to RxChCfg	1	1..*	

#### 6.6.6.14.1 RccCfg Object Associations

##### 6.6.6.14.1.1 RcpId

This key represents the 'Receive Channel Profile Identifier' (RCP-ID) configured for the MAC Domain indicated by this instance.

References: [MULPIv3.1] Standard Receive Channel Profile Encodings Annex.

##### 6.6.6.14.1.2 RccCfgId

This key denotes an RCC combination assignment for a particular RcpId and is unique per combination of MAC Domain and RcpId.

##### 6.6.6.14.1.3 VendorSpecific

This attribute contains vendor-specific information of the CM Receive Channel configuration.

References: [MULPIv3.1] Receive Channel Profile/Configuration Vendor Specific Parameters section in the Common Radio Frequency Interface Encodings Annex.

##### 6.6.6.14.1.4 Description

This attribute contains a human-readable description of the CM RCP Configuration.

#### 6.6.6.15 RxChCfg

The Receive Channel Configuration object permits an operator to configure how CMs registered with certain Receive Channel Profiles will configure the Receive Channels within their profile.

When a CM registers with a Receive Channel Profile (RCP) for which all Receive Channel Indices (RcIds) are configured in the Receive Module object and all Receive Channels are configured within this object, the CCAP SHOULD use the configuration within these objects to set the Receive Channel Configuration returned to the CM in a REG-RSP message.

The CCAP MAY require configuration of all pertinent Receive Module and Receive Channel instances in order to register a CM that reports a Receive Channel Profile (RCP), including any standard Receive Channel Profiles.

If the CM reports multiple RCPs, and Receive Module and Receive Channel objects have instances for more than one RCP, the particular RCP selected by the CCAP is not specified. A CCAP is not restricted to assigning Receive Modules based only on the contents of this object.

This object supports the creation and deletion of multiple instances.

Creation of a new instance of this object requires the reference of a valid RccCfg instance and a reference to a ChannelIndex.

The CMTS and CCAP MUST persist all instances of RxChCfg across reinitializations.

**Table 6-125 - RxChCfg Object Attributes<sup>32</sup>**

Attribute Name	Type	Required Attribute	Type Constraints	Units	Default
RcId	UnsignedByte	key	1..255		
PrimaryDsIndicator	PrimaryDsIndicatorType	No			notSpecified

**Table 6-126 - RxChCfg Object Associations**

Associated Object Name	Type	Near-end Multiplicity	Far-end Multiplicity	Label
RxModuleCfg*	Association with RxModuleCfg	0..*	0..1	
DocsisDownChannel	Directed aggregation to DocsisDownChannel			ChannelIndex
DsOfdmChannelCfg	Directed aggregation to DsOfdmChannelCfg	0..*	1	Index

\* If an RxModuleCfg is not specified, the Receive Channel Connectivity TLV is omitted from the RCC.

#### 6.6.6.6.15.1 RxChCfg Object Attributes

##### 6.6.6.6.15.1.1 RcId

This key represents an identifier for the parameters of the Receive Channel instance within the Receive Channel Profile.

References: [MULPIv3.1] Receive Channel Index section in the Common Radio Frequency Interface Encodings Annex.

##### 6.6.6.6.15.1.2 PrimaryDsIndicator<sup>33</sup>

This attribute encodes the type of downstream channel. Since support for backup primary channels is not required, the CCAP MAY reject configurations where this attribute is set to 'backupPrimary' if this feature is unsupported.

#### 6.6.6.6.16 RxModuleCfg

DOCSIS 3.1 uses simplified RCC messaging, and this object is ignored when using that mode of operation.

When operating in DOCSIS 3.0 mode, the Receive Module Configuration object permits an operator to configure how CMs with certain RCPs will configure the Receive Modules within their profile upon CM registration.

When a CM registers with an RCP for which all Receive Module Indices (RmIds) are configured in this object and all Receive Channels are configured within the Receive Channel (RxCh) object, the CCAP SHOULD use the configuration within these objects to set the Receive Channel Configuration assigned to the CM in a REG-RSP message.

<sup>32</sup> Modified per CCAP-OSSv3.1-N-15.1258-2 on 3/3/15 by KB.

<sup>33</sup> Modified per CCAP-OSSv3.1-N-15.1258-2 on 3/3/15 by KB.

The CCAP MAY require configuration of all pertinent Receive Module and Receive Channel instances in order to register a CM that reports a Receive Channel Profile.

If the CM reports multiple RCPs, and Receive Module and Receive Channel objects have instances for more than one RCP reported by the CM, the particular RCP selected by the CCAP is not specified. A CCAP is not restricted to assigning Receive Modules based only on the contents of this object.

This object supports the creation and deletion of multiple instances.

Creation of a new instance of this object requires the reference of a valid RccCfg instance.

The CMTS and CCAP MUST persist all instances of RxModuleCfg across reinitializations.

**Table 6-127 - RxModuleCfg Object Attributes**

Attribute Name	Type	Required Attribute	Type Constraints	Units	Default
RmId	UnsignedByte	Key	1..255		
FirstCenterFrequency	UnsignedInt	No		Hz	0

**Table 6-128 - RxModuleCfg Object Associations**

Associated Object Name	Type	Near-end Multiplicity	Far-end Multiplicity	Label
RxChCfg	Association with RxChCfg	0..1	0..*	
RxModuleCfg	Association with RxModuleCfg	0..1	0..*	

The CCAP MUST reject the configuration of an instance of RxModuleCfg that is associated with itself. If this object is not associated with another RxModuleCfg instance, the Receive Module Connectivity TLV is omitted from the RCC. The CCAP MUST reject the configuration of an instance of RxChCfg instances with circular references.

#### 6.6.6.6.16.1 RxModuleCfg Object Attributes

##### 6.6.6.6.16.1.1 RmId

This key represents an identifier of a Receive Module instance within the Receive Channel Profile.

References: [MULPIv3.1] Receive Module Index in the Common Radio Frequency Interface Encodings Annex.

##### 6.6.6.6.16.1.2 FirstCenterFrequency

This attribute represents the center frequency, in Hz, and a multiple of 62500, that indicates the low frequency channel of the Receive Module, or 0 if not applicable to the Receive Module.

References: [MULPIv3.1] Receive Module First Channel Center Frequency Assignment section in the Common Radio Frequency Interface Encodings Annex.

#### 6.6.6.6.17 DenyCm

This configuration object allows an operator to create a list of CM MAC addresses that are not allowed to register.

**Table 6-129 - DenyCm Object Attributes**

Attribute Name	Type	Required Attribute	Type Constraints	Units	Default Value
DeviceMacAddress	MacAddress	Yes (Key)			

#### 6.6.6.6.17.1 DenyCm Object Attributes

##### 6.6.6.6.17.1.1 DeviceMacAddress

The MAC address of the CM that will be added to the deny list. This attribute is used as a key.

#### 6.6.6.7 DOCSIS Multicast Authorization Configuration

The CCAP authorization module allows operators to selectively authorize access to multicast content for subscribers. This group of configuration elements allows for the configuration of DOCSIS Multicast Authorization. The configuration specific Information Model is shown below. This model provides the Multicast Conditional Access Model for the authorization of clients to join multicast sessions. The components of the Multicast Authorization model are:

- Ctrl, global configuration of Multicast authorization
- ProfileSessRule, DOCSIS Multicast profile-based authorization

A Multicast Authorization Profile Session rule consist of a pair source and group prefix addresses, an authorization action and a priority configured in the CMTS. This rule corresponds to the expansion of the IP Multicast Authorization Profile Name Subtype encoding signaled by the CM during registration.



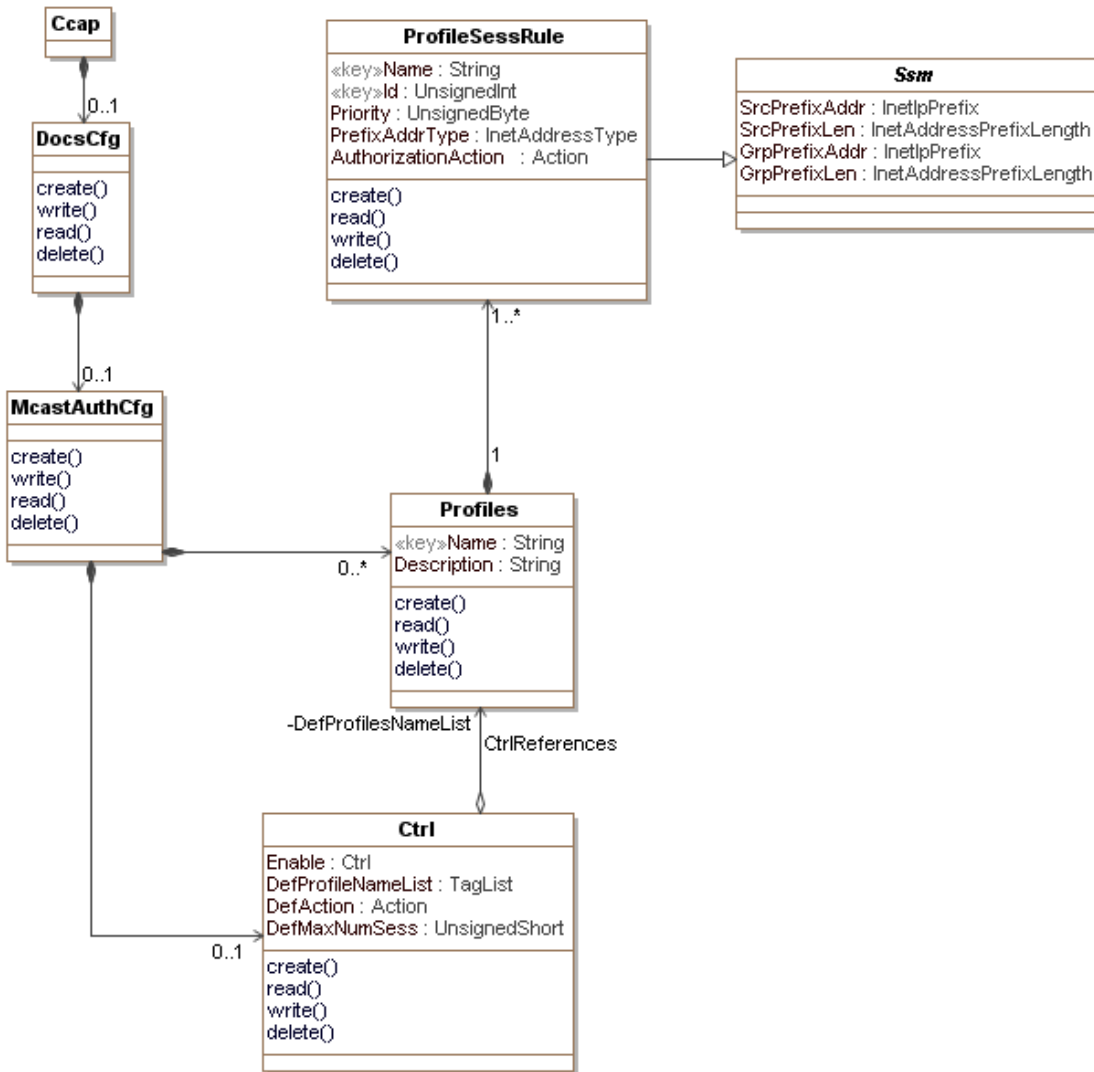

Figure 6-12 - DOCSIS Multicast Authorization Configuration Objects

6.6.6.7.1 Ccap

This configuration object is included in Figure 6-12 for reference. It is defined in Section 6.6.3.1, Ccap Object.

6.6.6.7.2 DocsCfg

This configuration object is included in Figure 6-12 for reference. It is defined in Section 6.6.6.1.2, DocsCfg.

6.6.6.7.3 McastAuthCfg

The McastAuthCfg object is the container for DOCSIS Multicast Authorization configuration objects. It has the following associations:

**Table 6-130 - McastAuthCfg Object Associations**

Associated Object Name	Type	Near-end Multiplicity	Far-end Multiplicity	Label
Profiles	Directed composition to Profiles		0..*	
Ctrl	Directed composition to Ctrl		0..1	

**6.6.6.7.4 Profiles**

This object contains the description of the Multicast Authorization profiles for administrative purposes.

This object supports the creation and deletion of multiple instances.

Creation of a new instance of this object requires the Name and Description attributes to be set.

The CMTS and CCAP MUST persist all instances of the Profiles object across reinitializations.

**Table 6-131 - Profiles Object Attributes**

Attribute Name	Type	Required Attribute	Type Constraints	Units	Default
Name	String	key	SIZE (1..15)		
Description	String	Yes			

**Table 6-132 - Profiles Object Associations**

Associated Object Name	Type	Near-end Multiplicity	Far-end Multiplicity	Label
ProfileSessRule	Directed composition to ProfileSessRule	1	1..*	

**6.6.6.7.4.1 Profiles Object Attributes**

**6.6.6.7.4.1.1 Name**

This attribute is a unique name or identifier for a Multicast Authorization Profile.

**6.6.6.7.4.1.2 Description**

This attribute is a human readable description of the Multicast Authorization Profile.

**6.6.6.7.5 Ctrl**

This object defines the CCAP global behavior for Multicast Authorization. Some parameters are included as part of the CM configuration process. In absence of those parameters, default values defined by attributes of this object are used.

The CMTS and CCAP MUST persist the values of the attributes of the Ctrl object across reinitializations.

**Table 6-133 - Ctrl Object Attributes**

Attribute Name	Type	Required Attribute	Type Constraints	Units	Default Value
Enable	Enum	No	other(1), enable(2), disable(3)		disable
DefProfileNameList	TagList	No			"H"
DefAction	Enum	No	other(1), accept(2), deny(3)		deny
DefMaxNumSess	UnsignedShort	No			0

**Table 6-134 - Ctrl Object Associations**

Associated Object Name	Type	Near-end Multiplicity	Far-end Multiplicity	Label
Profiles*	Directed aggregation to Profiles			DefProfilesNameList

\*This association indicates which Multicast Authorization Profiles are used by the CMTS when CMs register with no Multicast Join Authorization encodings in the REG-REQ-(MP). When IP Multicast Authorization is enforced, these associations provide the default set of Multicast Authorization Profiles the CMTS enforces for a CM in case the CM did not signal a set of profiles during the registration process. If no associations are specified, the DefAction attribute determines whether a join request is authorized. If the CMTS supports more than one profile as a default, the CMTS enforces each of the profiles in order of occurrence until the maximum number of profiles is reached.

#### 6.6.6.7.5.1 Ctrl Object Attributes

##### 6.6.6.7.5.1.1 Enable

This attribute enables the enforcement of Multicast Authorization feature. When this attribute is set to 'enable', Multicast Authorization is enforced; otherwise, clients are permitted to join any IP multicast session. The factory default value of this attribute is 'disable'.

##### 6.6.6.7.5.1.2 DefProfileNameList

When IP Multicast Authorization is enforced, this attribute provides the default set of Multicast Authorization Profiles the CMTS enforces for a CM in the case that this CM didn't signal a set of profiles during the registration process. If the Default Multicast Authorization Group Name is zero length string, the DefAction attribute determines whether a join request is authorized when a CM registers without a Multicast Authorization Profile Set or a list of config File Session Rules. If the CMTS supports more than 1 profile name as a default, the CMTS enforces each of the profiles in order until the maximum number of profiles is reached. This attribute indicates one or more Multicast Authorization Profiles.

##### 6.6.6.7.5.1.3 DefAction

This attribute defines the default authorization action when no IP Multicast Session Rule is determined to match a client's IP multicast JOIN request. The factory default of this attribute is 'deny'.

##### 6.6.6.7.5.1.4 DefMaxNumSess

This attribute indicates the default maximum number of multicast sessions that clients reached through a particular CM are allowed to join. A DefMaxNumSess value of 0 indicates that no dynamic joins are permitted. A Maximum Multicast Sessions Encoding value of 65535 (the largest valid value) indicates that the CMTS permits any number of sessions to be joined by clients reached through the CM.

References: [MULPIv3.1] Maximum Multicast Sessions section.

#### 6.6.6.7.6 ProfileSessRule

This object defines Operator configured profiles to be matched during the authorization process.

This object supports the creation and deletion of multiple instances.

Creation of a new instance of this object requires the following attributes to be set:

- SrcPrefixAddr
- SrcPrefixLen
- GrpPrefixAddr
- GrpPrefixLen

Each of these attributes is inherited from the abstract Ssm object.

The CMTS and CCAP MUST persist all instances of the ProfileSessRule object across reinitializations.

**Table 6-135 - ProfileSessRule Object Attributes**

Attribute Name	Type	Required Attribute	Type Constraints	Units	Default Value
Name	AdminString	key	SIZE (1..15)		
Id	unsignedInt	key	1..4294967295		
Priority	unsignedInt	No			0
PrefixAddrType	InetAddressType	Yes			
AuthorizationAction	Enum	No	other(1), accept(2), deny(3)		deny

**Table 6-136 - Ctrl Object Associations**

Associated Object Name	Type	Near-end Multiplicity	Far-end Multiplicity	Label
Ssm	Directed association to Ssm			DefProfilesNameList

6.6.6.7.6.1 ProfileSessRule Object Attributes

**6.6.6.7.6.1.1 Name**

This attribute is a unique name that associates the IP Multicast Authorization Profile Name Subtype encoding signaled by CMs with the a set of Multicast Authorization Profile Session Rules.

**6.6.6.7.6.1.2 Id**

This attribute provides a unique identifier for each CMTS configured Multicast Authorization Profile Session rule within a Multicast Authorization Profile Name.

**6.6.6.7.6.1.3 Priority**

This attribute configures the rule priority for the static session rule. Higher values indicate a higher priority. If more than one session rule matches a joined session, the session rule with the highest rule priority determines the authorization action.

**6.6.6.7.6.1.4 PrefixAddrType**

This attribute identifies the address family for the multicast session (S,G) which corresponds to the SrcPrefixAddr and GrpPrefixAddr attributes, respectively.

**6.6.6.7.6.1.5 AuthorizationAction**

This attribute specifies the authorization action for a session join attempt that matches the session rule.

The value 'accept' indicates that the rule permits a matching multicast join request is allowed. The value 'deny' indicates that a matching multicast join request is denied.

6.6.6.7.7 Ssm

This abstract object holds the shared source-specific multicast session address attributes used by the ProfileSessRule and the CmtsGrpCfg objects.

**Table 6-137 - Ssm Object Attributes**

Attribute Name	Type	Required Attribute	Type Constraints	Units	Default Value
SrcPrefixAddr	InetIpPrefix	Yes			
SrcPrefixLen	InetAddressPrefixLength	Yes			
GrpPrefixAddr	InetIpPrefix	Yes			
GrpPrefixLen	InetAddressPrefixLength	Yes			

#### 6.6.6.7.7.1 Ssm Object Attributes

##### 6.6.6.7.7.1.1 SrcPrefixAddr

This attribute identifies a specific Multicast Source Address defined for this rule. A Source Address that is all zeros is defined as 'all source addresses' (\*, G). Source prefix addresses are unicast addresses.

References: [RFC 3584] section 6; [RFC 3306] sections 5 and 6.

##### 6.6.6.7.7.1.2 SrcPrefixLen

This attribute identifies the prefix length associated with a range of Source (S) IP multicast group addresses. For Group or ASM based sessions this attribute is set to 0.

##### 6.6.6.7.7.1.3 GrpPrefixAddr

This attribute is the IP address corresponding to an IP multicast group.

##### 6.6.6.7.7.1.4 GrpPrefixLen

This attribute identifies the prefix length associated with a range of Group Destination IP multicast addresses.

### 6.6.6.8 DOCSIS Upstream Interface Configuration

The DOCSIS Upstream Interface configuration objects are shown in the following diagram.

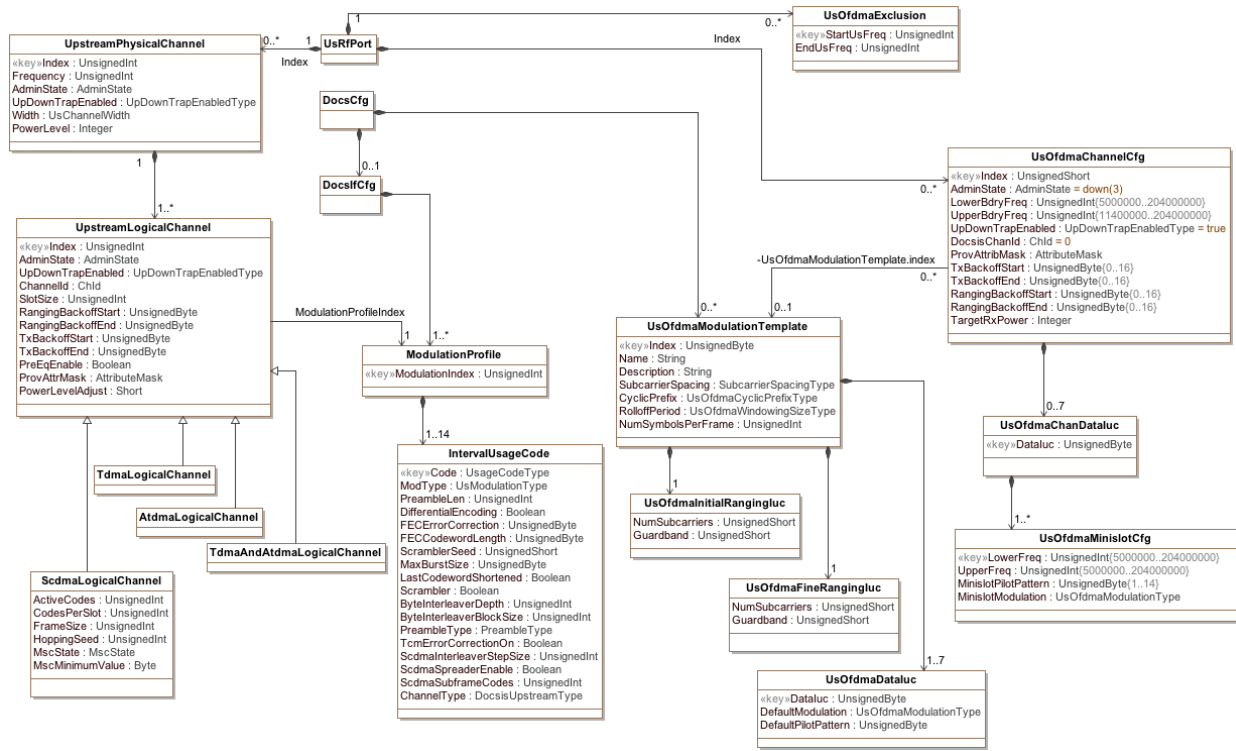

Figure 6-13 - DOCSIS Upstream Interface Configuration Objects<sup>34</sup>

#### 6.6.6.8.1 DocsCfg

This configuration object is included in Figure 6-13 for reference. It is defined in Section 6.6.6.1.2, DocsCfg.

#### 6.6.6.8.2 DocsIfCfg

The DocsIfCfg object is the container for the DOCSIS 3.0 upstream interface configuration objects. It has the following associations:

Table 6-138 - DocsIfCfg Object Associations

Associated Object Name	Type	Near-end Multiplicity	Far-end Multiplicity	Label
ModulationProfile	Directed composition to ModulationProfile		1..*	

#### 6.6.6.8.3 ModulationProfile

This object allows a modulation profile to be associated to a DOCSIS 3.0 upstream logical channel. It has a single attribute, ModulationIndex, which is based on the Index attribute defined in docsIfCmtsModulationTable defined in [RFC 4546].

Reference: [RFC 4546], docsIfCmtsModulationTable

<sup>34</sup> Modified per CCAP-OSSlv3.1-N-15.1322-1 on 7/20/15 by KB; per CCAP-OSSlv3.1-N-16.1439-3 on 5/13/16 by KB.

**Table 6-139 - ModulationProfile Object Attributes**

Attribute Name	Type	Required Attribute	Type Constraints	Units	Default
ModulationIndex	unsignedInt	Yes (key)			

**Table 6-140 - ModulationProfile Object Associations**

Associated Object Name	Type	Near-end Multiplicity	Far-end Multiplicity	Label
IntervalUsageCode	Directed composition to IntervalUsageCode		1..14	

#### 6.6.6.8.3.1 ModulationIndex

An index into the Channel Modulation table representing a group of Interval Usage Codes, all associated with the same channel.

#### 6.6.6.8.4 IntervalUsageCode

This object allows a list of interval usage codes to be associated with a single modulation profile. It is based on the docsIfCmtsModulationTable defined in [RFC 4546] and will be used with the following modifications for CCAP. The following attributes have been removed:

- ModulationIndex (included in the ModulationProfile object)
- StorageType
- Control
- GuardTimeSize

The IntervalUsageCode attribute has been renamed Code.

The ModType, PreambleType and ChannelType attributes have had the unknown enumerations removed and a new enumeration, other(1), added to allow for vendor extension. The enumeration definitions can be found in the following attributes table.

Reference: [RFC 4546], docsIfCmtsModulationTable

**Table 6-141 - IntervalUsageCode Object Attributes**

Attribute Name	Type	Required Attribute	Type Constraints	Units	Default Value
ModType	Enum	No	other(1), qpsk(2), qam8(3), qam16(4), qam32(5), qam64(6), qam128(7)		qpsk
PreambleType	Enum	Yes	other(1), qpsk0(2), qpsk1(3)		
ChannelType	Enum	Yes	other(1), tdma(2), atdma(3), scdma(4), tdmaAtdma(5)		

6.6.6.8.5 *UsRfPort*

This configuration object is included in Figure 6-13 for reference. It is defined in Section 6.6.4.13, UsRfPort.

6.6.6.8.6 *UpstreamPhysicalChannel*

The UpstreamPhysicalChannel object represents SC-QAM operation on a single upstream center frequency at a particular channel width.

Since CCAP is expected to operate with only DOCSIS 2.0 or later upstream channels, at least one UpstreamLogicalChannel object (ifType 205) is needed to be instantiated to operate within an UpstreamPhysicalChannel.

This object differs from previous objects in DOCSIS in that the desired input power is now set at the UpstreamPhysicalChannel and not on a per-UpstreamLogicalChannel instance. If the target receive power level for an individual logical channel under a physical channel is desired to be different than the target power level for the physical channel, this can be configured using the PowerLevelAdjust attribute of the UpstreamLogicalChannel object.

**Table 6-142 - UpstreamPhysicalChannel Object Attributes**

Attribute Name	Type	Required Attribute	Type Constraints	Units	Default Value
Index	UnsignedInt	Yes (Key)	1..*		
Frequency	UnsignedInt	Yes	5,000,000..85,000,000	Hertz	
Width	Enum	Yes	other(1), 200000(2), 400000(3), 800000(4), 1600000(5), 3200000(6), 6400000(7)	Hertz	
AdminState	AdminState	No			down
UpDownTrapEnabled	UpDownTrapEnabled	No			true
PowerLevel	Integer	Yes		TenthdBmV	

An UpstreamPhysicalChannel is contained by a single UsRfPort. It contains one or more UpstreamLogicalChannel objects. It is referenced by a single MacDomain.

**Table 6-143 - UpstreamPhysicalChannel Object Associations**

Associated Object Name	Type	Near-end Multiplicity	Far-end Multiplicity	Label
UpstreamLogicalChannel	Directed composition to UpstreamLogicalChannel	1	1..*	

6.6.6.8.6.1 *UpstreamPhysicalChannel Requirements*

The CCAP MUST reject activation of a set of configuration objects that would cause an overlap of RF channel frequency on any single upstream RF port.

6.6.6.8.6.2 *UpstreamPhysicalChannel Object Attributes*

6.6.6.8.6.2.1 **Index**

This attribute uniquely identifies an SC-QAM UpstreamPhysicalChannel on its UsRfPort. Its value is between one and the maximum number of UpstreamPhysicalChannels supported on the UsRfPort, inclusive.



### 6.6.6.8.6.2.2 Frequency

This attribute configures the center frequency of the UpstreamPhysicalChannel, in Hertz. For DOCSIS 3.0 operation, the minimum permitted value is the center frequency such that the lower channel edge is 5000000 Hz and the maximum permitted value is the center frequency at which the upper channel edge is 85000000 Hz. This attribute corresponds to the docsIfUpChannelFrequency object of DOCS-IF-MIB [RFC 4546]. The CCAP MUST reject the configuration of an UpstreamPhysicalChannel instance that overlaps in frequency with another UpstreamPhysicalChannel instance on the same upstream RF port.

### 6.6.6.8.6.2.3 Width

This attribute configures the width of the UpstreamPhysicalChannel, in Hertz. While the only permitted values for DOCSIS 3.0 are 1,600,000, 3,200,000, and 6,400,000, this specification also includes widths of 200,000, 400,000, and 800,000 for backward compatibility. This attribute corresponds to the docsIfUpChannelFrequency object of DOCS-IF-MIB [RFC 4546].

The value of other(1) is used when a vendor-extension has been implemented for this attribute.

### 6.6.6.8.6.2.4 AdminState

This attribute configures the administrative state of this instance.

### 6.6.6.8.6.2.5 UpDownTrapEnabled

This attribute configures whether linkUp/linkDown traps are enabled for this channel.

### 6.6.6.8.6.2.6 PowerLevel<sup>35</sup>

This attribute configures the desired input power level, in TenthdBmV, common to all upstream logical channels associated with this physical channel instance. This attribute represents the desired total average receive power for the channel regardless of whether there are 3.1 CMs operational on the channel. The power level for an individual logical channel can deviate from the common power level through the configuration of the PowerLevelAdjust attribute of the UpstreamLogicalChannel object.

### 6.6.6.8.7 UpstreamLogicalChannel

The UpstreamLogicalChannel object represents scheduled intervals of time on a single UpstreamPhysicalChannel. An SC-QAM UpstreamLogicalChannel is either SCDMA, TDMA, ATDMA, or both TDMA and ATDMA. Each UpstreamLogicalChannel is identified with a DOCSIS upstream channel ID. The MAP management messages transmitted downstream by the CCAP schedule intervals of time for each DOCSIS upstream channel ID. In the SNMP MIB, an UpstreamLogicalChannel is an interface with ifType UpstreamLogicalChannel (205).

**Table 6-144 - UpstreamLogicalChannel Object Attributes**

Attribute Name	Type	Required Attribute	Type Constraints	Units	Default Value
Index	UnsignedInt	Yes (Key)			
AdminState	AdminState	No			down
UpDownTrapEnabled	UpDownTrapEnabled	No			false
ChannelId	ChId	No			0
SlotSize	UnsignedInt	Yes		ticks	
RangingBackoffStart	UnsignedByte	Yes	0..16	power of 2	
RangingBackoffEnd	UnsignedByte	Yes	0..16	power of 2	
TxBBackoffStart	UnsignedByte	Yes	0..16		
TxBBackoffEnd	UnsignedByte	Yes	0..16		
PreEqEnable	Boolean	Yes			
ProvAttrMask	AttributeMask	Yes			
PowerLevelAdjust	Short	No		TenthdB	0

<sup>35</sup> Modified per CCAP-OSSiv3.1-N-16.1464-3 on 5/13/16 by KB.

This object differs from the same object in previous versions of DOCSIS in that the desired common input power is now set at the Upstream Physical Channel and power level adjustments can only be configured on a per UpstreamLogicalChannel basis.

**Table 6-145 - UpstreamLogicalChannel Object Associations**

Associated Object Name	Type	Near-end Multiplicity	Far-end Multiplicity	Label
ModulationProfile	Directed association to ModulationProfile		1	ModulationProfileIndex

#### 6.6.6.8.7.1 UpstreamLogicalChannel Object Attributes

##### 6.6.6.8.7.1.1 Index

This key attribute uniquely identifies an SC-QAM UpstreamLogicalChannel operating on the center frequency and width of a single UpstreamPhysicalChannel. This index is in the range between one and the maximum number of UpstreamLogicalChannel objects supported by the CCAP on an UpstreamPhysicalChannel.

##### 6.6.6.8.7.1.2 AdminState

This attribute stores the administrative state of the upstream logical channel.

##### 6.6.6.8.7.1.3 UpDownTrapEnabled

This attribute configures whether linkUp/linkDown traps are enabled for this channel.

##### 6.6.6.8.7.1.4 ChannelId

This attribute permits an operator to optionally configure the upstream channel ID signaled in the DOCSIS protocol for the UpstreamLogicalChannel. By default, the CCAP will automatically assign the DocsisUpChannelId. An operator can create or update this attribute with a value to force the CCAP to use the configured DOCSIS channel ID. A unique configured value exists within the MacDomain to which the UpstreamPhysicalChannel containing this UpstreamLogicalChannel is associated. A value of 0 means that the CCAP should automatically assign the ChannelId.

##### 6.6.6.8.7.1.5 SlotSize

This attribute configures the number of 6.25 microsecond ticks in each upstream minislot for the UpstreamLogicalChannel. This attribute may have different values for the different UpstreamLogicalChannel objects on the same UpstreamPhysicalChannel. This attribute is applicable to TDMA and ATDMA channel types only; its value is read and written as zero for SDCMA type channels.

##### 6.6.6.8.7.1.6 RangingBackoffStart

This attribute is the initial random back-off window to use when retrying Ranging Requests. It is expressed as a power of 2. A configured value of 16 indicates that a proprietary adaptive retry mechanism is to be used.

##### 6.6.6.8.7.1.7 RangingBackoffEnd

This attribute is the final random back-off window to use when retrying Ranging Requests. It is expressed as a power of 2. A configured value of 16 indicates that a proprietary adaptive retry mechanism is to be used.

##### 6.6.6.8.7.1.8 TxBackoffStart

The initial random back-off window to use when retrying transmissions. Expressed as a power of 2. A configured value of 16 indicates that a proprietary adaptive retry mechanism is to be used. See the associated conformance object for write conditions and limitations.

**6.6.6.8.7.1.9 TxBackoffEnd**

The final random back-off window to use when retrying transmissions. Expressed as a power of 2. A configured value of 16 indicates that a proprietary adaptive retry mechanism is to be used. See the associated conformance object for write conditions and limitations.

**6.6.6.8.7.1.10 PreEqEnable**

This attribute enables pre-equalization on the UpstreamLogicalChannel when its value is true, or disables pre-equalization when its value is false.

**6.6.6.8.7.1.11 ProvAttrMask**

This attribute configures the 32-bit Provisioned Attribute Mask for the UpstreamLogicalChannel. This is used by a CCAP to control how upstream service flows are assigned to the UpstreamLogicalChannel.

**6.6.6.8.7.1.12 PowerLevelAdjust**

This attribute configures the adjustment from the common power level configured for the physical US channel; it is expressed in TenthdB. The sum of the UpstreamPhysicalChannel PowerLevel and UpstreamLogicalChannel PowerLevelAdjust determines the expected input power level for the logical channel. If the CCAP does not support the ability to set the PowerLevelAdjust attribute to a non-zero value, the CCAP MAY log an error upon execution of an XML configuration file that contains a negative attribute value.

**6.6.6.8.8 ScdmaLogicalChannel**

This configuration object is constructed from the SCDMA fields of the docsIfUpstreamChannelTable defined in [RFC 4546] and [DOCS-IFEXT2-MIB], and these attributes are used with the following modification for CCAP: a value of "other" has been added to the MscState attribute's enumeration to allow for vendor extension. The enumeration definition can be found in the following attributes table.

The Scdma object is an optional grouping of additional parameters to an UpstreamLogicalChannel that is defined only for UpstreamLogicalChannel objects that reference an SCDMA modulation profile.

References: [RFC 4546], docsIfUpstreamChannelTable; [DOCS-IFEXT2-MIB]

**Table 6-146 - ScdmaLogicalChannel Object Attributes**

Attribute Name	Type	Required Attribute	Type Constraints	Units	Default Value
MscState	Enum	No	other(1), channelEnabled(2), channelDisabled(3), dormant(4)		channelDisabled

**Table 6-147 - ScdmaLogicalChannel Object Associations**

Associated Object Name	Type	Near-end Multiplicity	Far-end Multiplicity	Units	Default Value
UpstreamLogicalChannel	Specialization of UpstreamLogicalChannel				

**6.6.6.8.9 TdmaLogicalChannel**

This configuration object is a specialization of the docsIfUpstreamChannelTable defined in [RFC 4546] for TDMA logical channels.

References: [RFC 4546], docsIfUpstreamChannelTable; Annex A

**Table 6-148 - TdmaLogicalChannel Object Associations**

Associated Object Name	Type	Near-end Multiplicity	Far-end Multiplicity	Units	Default Value
UpstreamLogicalChannel	Specialization of UpstreamLogicalChannel				

**6.6.6.8.10 AtdmaLogicalChannel**

This configuration object is a specialization of the docsIfUpstreamChannelTable defined in [RFC 4546] for ATDMA logical channels.

References: [RFC 4546], docsIfUpstreamChannelTable; Annex A

**Table 6-149 - AtdmaLogicalChannel Object Associations**

Associated Object Name	Type	Near-end Multiplicity	Far-end Multiplicity	Units	Default Value
UpstreamLogicalChannel	Specialization of UpstreamLogicalChannel				

**6.6.6.8.11 TdmaAndAtdmaLogicalChannel**

This configuration object is a specialization of the docsIfUpstreamChannelTable defined in [RFC 4546] for mixed TDMA/ATDMA logical channels.

References: [RFC 4546], docsIfUpstreamChannelTable; Annex A

**Table 6-150 - TdmaAndAtdmaLogicalChannel Object Associations**

Associated Object Name	Type	Near-end Multiplicity	Far-end Multiplicity	Units	Default Value
Scdma	Specialization of UpstreamLogicalChannel				

**6.6.6.8.12 UsOfdmaChannelCfg<sup>36</sup>**

This object specifies the upstream OFDMA Parameters for a single upstream OFDMA channel.

**Table 6-151 - UsOfdmaChannelCfg Object Attributes**

Attribute Name	Type	Required Attribute	Type Constraints	Units	Default Value
Index	UnsignedShort	Key			
AdminState	AdminState	No			down
LowerBdryFreq	UnsignedInt	Yes	5000000..197600000	Hz	
UpperBdryFreq	UnsignedInt	Yes	11400000..204000000	Hz	
UpDownTrapEnabled	UpDownTrapEnabled	No			true
DocsisChanId	ChId	No			0
ProvAttribMask	AttributeMask	Yes			
TxBckoffStart	UnsignedByte	Yes	0..16	power of 2	
TxBckoffEnd	UnsignedByte	Yes	0..16	power of 2	
RangingBckoffStart	UnsignedByte	Yes	0..16	power of 2	
RangingBckoffEnd	UnsignedByte	Yes	0..16	power of 2	
TargetRxPower	UnsignedInt	Yes		TenthdBmV	

<sup>36</sup> Section and subsections modified per CCAP-OSSv3.1-N-15.1307-3 on 6/1/15 by KB; per CCAP-OSSv3.1-N-15.1322-1 on 7/20/15 by KB; per CCAP-OSSv3.1-N-16.1439-3 on 5/13/16 by KB.

**Table 6-152 - UsOfdmaChannelCfg Object Associations**

Associated Object Name	Type	Near-end Multiplicity	Far-end Multiplicity	Label
UsOfdmaModulationTemplate*	Directed association to UsOfdmaModulationTemplate	0..*	0..1	UsOfdmaModulationTemplate.Index
UsOfdmaChanDataIuc	Directed composition to UsOfdmaChanDataIuc	1	0..7	

\*A template does not need to be assigned if the vendor supports automatic profile assignment.

#### 6.6.6.8.12.1 UsOfdmaChannelCfg Object Attributes

##### 6.6.6.8.12.1.1 Index

This attribute is a key defined to provide an index into the table.

##### 6.6.6.8.12.1.2 AdminState

This attribute is the admin state for the upstream OFDMA channel.

##### 6.6.6.8.12.1.3 LowerBdryFreq<sup>37</sup>

This attribute defines the lower frequency for the US Channel.

Per the CM Transmitter Output Signal Characteristics table in [PHYv3.1], the minimum occupied bandwidth is 6.4 MHz and 10 MHz for 25 kHz and 50 kHz Subcarrier Spacing, respectively. Thus, for 25kHz Subcarrier Spacing the maximum value for this attribute is 197,600,000 Hz and for 50 kHz Subcarrier Spacing the maximum value for this attribute is 194,000,000 Hz.

The minimum *configured* bandwidth for an OFDMA channel includes both 500 kHz guard bands along with the minimum bandwidth. This gives the minimum configured OFDMA channel bandwidth as 7.4 MHz and 11 MHz for 25 kHz and 50 kHz Subcarrier Spacing, respectively. When an OFDMA channel is configured with 25 kHz Subcarrier Spacing, the CCAP MUST reject configurations where UpperBdryFreq - LowerBdryFreq < 7.4 MHz. Similarly, when an OFDMA channel is configured with 50 kHz Subcarrier Spacing, the CCAP MUST reject configurations where UpperBdryFreq - LowerBdryFreq < 11 MHz.

##### 6.6.6.8.12.1.4 UpperBdryFreq

This attribute defines the upper frequency for the US Channel. The CCAP MUST reject configurations where UpperBdryFreq - LowerBdryFreq > 96 MHz.

##### 6.6.6.8.12.1.5 UpDownTrapEnabled

This attribute indicates if a trap should be sent when the Channel transitions from enable to disable and disable to enable.

##### 6.6.6.8.12.1.6 DocsisChanId

This attribute permits an operator to optionally configure the upstream channel ID signaled in the DOCSIS protocol for the OFDMA upstream channel. By default, the CCAP will automatically assign the DOCSIS Channel ID. An operator can create or update this attribute with a value to force the CCAP to use the configured DOCSIS Channel ID. A unique configured value exists within the MacDomain to which the OFDMA Channel is associated for each channel in that MacDomain - SC or OFDMA. A value of 0 means that the CCAP should automatically assign the Channel ID.

<sup>37</sup> Modified by CCAP-OSSiv3.1-N-15.1394-1on 11/10/15 by KB.

**6.6.6.8.12.1.7 ProvAttribMask**

This attribute configures the 32-bit Provisioned Attribute Mask for the OFDMA upstream channel. This is used by a CCAP to control how upstream service flows are assigned to the OFDMA upstream channel.

**6.6.6.8.12.1.8 TxBackoffStart**

This attribute is the initial random back-off window to use when retrying transmissions. Expressed as a power of 2. A configured value of 16 indicates that a proprietary adaptive retry mechanism is to be used. See the associated conformance object for write conditions and limitations.

**6.6.6.8.12.1.9 TxBackoffEnd**

This attribute is the final random back-off window to use when retrying transmissions. Expressed as a power of 2. A configured value of 16 indicates that a proprietary adaptive retry mechanism is to be used. See the associated conformance object for write conditions and limitations.

**6.6.6.8.12.1.10 RangingBackoffStart**

This attribute is the initial random back-off window to use when retrying Ranging Requests. It is expressed as a power of 2. A configured value of 16 indicates that a proprietary adaptive retry mechanism is to be used.

**6.6.6.8.12.1.11 RangingBackoffEnd**

This attribute is the final random back-off window to use when retrying Ranging Requests. It is expressed as a power of 2. A configured value of 16 indicates that a proprietary adaptive retry mechanism is to be used.

**6.6.6.8.12.1.12 TargetRxPower<sup>38</sup>**

This attribute provides the power of the expected commanded received signal in the channel, referenced to the CCAP input. The value represents the power spectral density in an equivalent 1.6 MHz spectrum.

**6.6.6.8.13 UsOfdmaChanDataluc**

This object specifies the US OFDMA data IUC whose defaults are being changed for some frequency range within the channel.

**Table 6-153 - UsOfdmaChanDataluc Object Attributes**

Attribute Name	Type	Required Attribute	Type Constraints	Units	Default Value
Dataluc	UnsignedByte	Key	5 6 9 10 11 12 13		

**Table 6-154 - UsOfdmaChanDataluc Object Associations**

Associated Object Name	Type	Near-end Multiplicity	Far-end Multiplicity	Label
UsOfdmaMinislotCfg	Directed composition to UsOfdmaMinislotCfg	1	1..*	

**6.6.6.8.13.1 UsOfdmaChanDataluc Attributes**

**6.6.6.8.13.1.1 DataIuc**

This attribute is the data IUC being configured.

<sup>38</sup> Modified per CCAP-OSSv3.1-N-16.1464-3 on 5/16/16 by KB.

#### 6.6.6.8.14 *UsOfdmaMinislotCfg*

This object defines the modulation and pilot pattern for one or more consecutively numbered minislots, where one or both of these parameters differ from the default for the OFDMA profile for this channel. The minislots affected are defined by a frequency range. If partial minislots match the frequency range, it is vendor dependent whether those partially-matching minislots use the modulation and pilot pattern as defined in this object or the modulation and pilot pattern defined by the modulation profile.

**Table 6-155 - *UsOfdmaMinislotCfg* Object Attributes**

Attribute Name	Type	Required Attribute	Type Constraints	Units	Default Value
LowerFreq	UnsignedInt	Key	5000000-197600000	Hz	
UpperFreq	UnsignedInt	Yes	11400000-204000000	Hz	
MinislotPilotPattern	UnsignedByte	Yes	1..14		
MinislotModulation	UsOfdmaModulationType	Yes			

#### 6.6.6.8.14.1 *UsOfdmaMinislotCfg* Attributes

##### 6.6.6.8.14.1.1 **LowerFreq**

This attribute defines the start frequency where the minislots will use the pilot pattern and modulation as specified by this object, instead of the defaults for the channel. LowerFreq needs to be within the frequencies allotted to the channel. The CCAP MUST reject a configuration where the lower frequency is outside of the channel frequency range.

##### 6.6.6.8.14.1.2 **UpperFreq**

This attribute defines the end frequency where the minislots will use the pilot pattern and modulation as specified by this object, instead of the defaults for the channel. The UpperFreq value needs to be greater than or equal the LowerFreq value. The CCAP MUST reject a configuration where the upper frequency is outside of the channel frequency range.

##### 6.6.6.8.14.1.3 **MinislotPilotPattern**

This attribute defines the pilot pattern for the minislot. All samples in the minislot have the same pilot pattern. Channels using 2k mode are restricted to patterns 1-7. In 2k mode, the CCAP MUST reject a configuration with mixture of pilot patterns 1-4 and 5-7 on the same OFDMA channel.

Channels using 4k mode are restricted to patterns 8-14. In 4k mode, the CCAP MUST reject a configuration with a mixture of pilot patterns 8-11 and 12-14 on the same OFDMA channel.

Reference: [PHYv3.1], Upstream Pilot Pattern section

##### 6.6.6.8.14.1.4 **MinislotModulation**

This attribute defines the modulation for the minislot. All samples in the minislot have the same modulation.

#### 6.6.6.8.15 *UsOfdmaExclusion*<sup>39</sup>

This object specifies an exclusion band for an OFDMA channel. Exclusion bands can be located anywhere in the upstream spectrum and can be as small as one subcarrier.

An OFDMA channel can contain multiple exclusion bands. The CCAP uses these frequency ranges to create a list of subcarriers that fall within these frequencies that will have no signal.

<sup>39</sup> Modified by CCAP-OSSiv3.1-N-15.1394-1on 11/10/15 by KB; per CCAP-OSSiv3.1-N-16.1439-3 on 5/13/16 by KB.

The CCAP MUST reject the configuration of exclusions if the total number of active subcarriers would fall below  $6400 / 25 = 256$  for 25 kHz Subcarrier Spacing or below  $10000 / 50 = 200$  for 50 kHz Subcarrier Spacing.

**Table 6-156 - UsOfdmaExclusion Object Attributes**

Attribute Name	Type	Required Attribute	Type Constraints	Units	Default Value
StartUsFreq	UnsignedInt	Key	5000000..204000000	Hz	
EndUsFreq	UnsignedInt	Yes	5000000..204000000	Hz	

6.6.6.8.15.1 UsOfdmaExclusion Object Attributes

**6.6.6.8.15.1.1 StartUsFreq**

This attribute defines the beginning frequency of the exclusion band.

**6.6.6.8.15.1.2 EndUsFreq**

This attribute defines the end frequency of the exclusion band. The CCAP MUST reject configurations where  $UpperUsFreq < LowerUsFreq$ . The CCAP SHOULD reject configurations which contain exclusion frequency ranges that overlap. Note: If the boundary of an exclusion falls within the frequency range of a configured subcarrier, the CCAP will exclude the entire subcarrier.

6.6.6.8.16 UsOfdmaModulationTemplate

UsOfdmaModulationTemplates are global. Each defines some of the US channel parameters, plus provides a definition for the two ranging IUCs and for at least one data IUC.

**Table 6-157 - UsOfdmaModulationTemplate Object Attributes**

Attribute Name	Type	Required Attribute	Type Constraints	Units	Default Value
Index	UnsignedByte	Key			
Name	String	Yes	1..32		
Description	String	No	0..255		''
SubcarrierSpacing	Enum	Yes	other(1), 25kHz(2), 50kHz(3)		
CyclicPrefix	UsOfdmaCyclicPrefixType	Yes		Number of samples	
RolloffPeriod	UsOfdmaWindowingSizeType	Yes		Number of samples	
NumSymbolsPerFrame	UnsignedInt	Yes	6..36		

**Table 6-158 - UsOfdmaModulationTemplate Object Associations**

Associated Object Name	Type	Near-end Multiplicity	Far-end Multiplicity	Label
UsOfdmaInitialRangingIuc	Directed composition to UsOfdmaInitialRangingIuc	1	1	
UsOfdmaFineRangingIuc	Directed composition to UsOfdmaFineRangingIuc	1	1	
UsOfdmaDataIuc	Directed composition to UsOfdmaDataIuc	1	1..7	

6.6.6.8.16.1 UsOfdmaModulationTemplate Object Attributes

**6.6.6.8.16.1.1 Index**

This attribute is a key defined to provide an index into the table.



**6.6.6.8.16.1.2 Name**

This attribute contains the name of this OFDMA modulation profile.

**6.6.6.8.16.1.3 Description**

This attribute contains a description of this OFDMA modulation profile.

**6.6.6.8.16.1.4 SubcarrierSpacing**

This attribute defines the subcarrier spacing and, therefore, the FFT (2k or 4k) for the channel.

**6.6.6.8.16.1.5 CyclicPrefix**

This data type is defined to specify the allowed values for applying cyclic prefix for mitigating interference due to microreflections.

**6.6.6.8.16.1.6 RolloffPeriod**

This data type is defined to specify the allowed values for applying windowing to maximize the capacity of the upstream channel.

**6.6.6.8.16.1.7 NumSymbolsPerFrame**

In [PHYv3.1], this attribute is referred to as K the “Number of symbol periods per frame.” For 50 kHz Subcarrier Spacing, the CCAP MUST reject configurations where NumSymbolsPerFrame exceeds Kmax and where Kmax is defined in [PHYv3.1] as follows:

$K_{max} = 18$  for  $BW > 72$  MHz

$K_{max} = 24$  for  $48 \text{ MHz} < BW < 72$  MHz

$K_{max} = 36$  for  $BW < 48$  MHz

For 25 KHz Subcarrier Spacing, the CCAP MUST reject configurations where NumSymbolsPerFrame exceeds Kmax where Kmax is defined in [PHYv3.1] as follows:

$K_{max} = 9$  for  $BW > 72$  MHz

$K_{max} = 12$  for  $48 \text{ MHz} < BW < 72$  MHz

$K_{max} = 18$  for  $BW < 48$  MHz

Where BW is defined as the encompassed spectrum of the associated OFDMA channel.

Reference: [PHYv3.1] Minislot Structure.

**6.6.6.8.17 UsOfdmaInitialRangingIuc**

This object specifies an initial ranging Interval Usage Code (IUC type 3) for OFDMA US channels.

**Table 6-159 - UsOfdmaInitialRangingIuc Object Attributes**

Attribute Name	Type	Required Attribute	Type Constraints	Units	Default Value
NumSubcarriers	UnsignedShort	Yes	16..128		
GuardBand	UnsignedShort	Yes		Hz	

**6.6.6.8.17.1 UsOfdmaInitialRangingIuc Object Attributes****6.6.6.8.17.1.1 NumSubcarriers**

This attribute defines maximum number of subcarriers for fine ranging. This is the maximum number of subcarriers for initial ranging, not including the guard band. This value is limited to a maximum of 64 subcarriers with 50 kHz

subcarrier spacing and a maximum of 128 subcarriers with 25 kHz subcarrier spacing ([PHYv3.1], section Allowed Values and Ranges for Configuration Parameters).

#### 6.6.6.8.17.1.2 GuardBand<sup>40</sup>

This attribute is the sum of the upper and lower guard bands for initial ranging in Hz. The valid range is implementation-specific.

#### 6.6.6.8.18 UsOfdmaFineRangingIuc

This object specifies an initial ranging Interval Usage Code (IUC type 4) for OFDMA US channels.

**Table 6-160 - UsOfdmaFineRangingIuc Object Attributes**

Attribute Name	Type	Required Attribute	Type Constraints	Units	Default Value
NumSubcarriers	UnsignedShort	Yes	16..512		
GuardBand	UnsignedInt	Yes		Hz	

#### 6.6.6.8.18.1 UsOfdmaFineRangingIuc Object Attributes

##### 6.6.6.8.18.1.1 NumSubcarriers

This attribute defines maximum number of subcarriers for fine ranging. The following rules apply ([PHYv3.1], Allowed Values and Ranges for Configuration Parameters):

- The maximum number of subcarriers for fine ranging, including subcarriers in the exclusion zones but excluding the guard band, cannot exceed 512 subcarriers with either 25 kHz or 50 kHz subcarrier spacing. The CCAP MUST reject a fine ranging configuration that includes more than 512 subcarriers, not including the guard band.
- The maximum number of subcarriers for fine ranging, excluding the subcarriers in the guard band and subcarriers in the exclusion bands, cannot exceed 256 subcarriers with 50 kHz subcarrier spacing and cannot exceed 512 subcarriers with 25 kHz subcarrier spacing. Note that if 512 subcarriers are used, there cannot be exclusion bands within the fine ranging signal to comply with the previous requirement. The CCAP MUST reject a fine ranging configuration that does not meet these guidelines.

##### 6.6.6.8.18.1.2 GuardBand<sup>41</sup>

This attribute is the sum of the upper and lower guard bands for fine ranging in Hz. The valid range is implementation-specific.

#### 6.6.6.8.19 UsOfdmaDataIuc

This object specifies a data Interval Usage Code for OFDMA upstream channels. The CCAP MUST reject configuration of a UsOfdmaModulationTemplate that does not contain an instance of IUC 13.

**Table 6-161 - UsOfdmaDataIuc Object Attributes**

Attribute Name	Type	Required Attribute	Type Constraints	Units	Default Value
DataIuc	UnsignedByte	Key	5 6 9 10 11 12 13		
DefaultModulation	UsOfdmaModulationType	Yes			
DefaultPilotPattern	UnsignedByte	Yes	1..14		

<sup>40</sup> Modified per CCAP-OSSv3.1-N-15.1258-2 on 3/3/15 by KB.

<sup>41</sup> Modified per CCAP-OSSv3.1-N-15.1258-2 on 3/3/15 by KB.

6.6.6.8.19.1 UsOfdmDataIuc Object Attributes

6.6.6.8.19.1.1 DataIuc

This attribute is a key into the UsOfdmaDataIuc table. The CCAP MUST reject configurations which do not contain an instance with a value of 13 (IUC 13 represents the lowest common denominator OFDMA profile for a given upstream channel).

Reference: [MULPIv3.1], Assignment of OFDMA Upstream Data Profile (OUDP) IUCs

6.6.6.8.19.1.2 DefaultModulation

This attribute is the default modulation for the minislots in this US OFDMA channel.

6.6.6.8.19.1.3 DefaultPilotPattern

This attribute is default pilot pattern for the minislots in this US OFDMA channel. Channels using 2k mode are restricted to patterns 1-7, while channels using 4k mode are restricted to patterns 8-14 ([PHYv3.1], Upstream Pilot Pattern section). In 2k mode, the CCAP MUST reject a configuration that allows a mixture of pilot patterns 1-4 and 5-7 on the same OFDMA modulation template. In 4k mode, the CCAP MUST reject a configuration that allows a mixture of pilot patterns 8-11 and 12-14 on the same OFDMA modulation template.

6.6.6.9 Downstream DOCSIS and Video Channel Configuration

The Downstream DOCSIS and Video Channel configuration objects are shown in the following diagram.

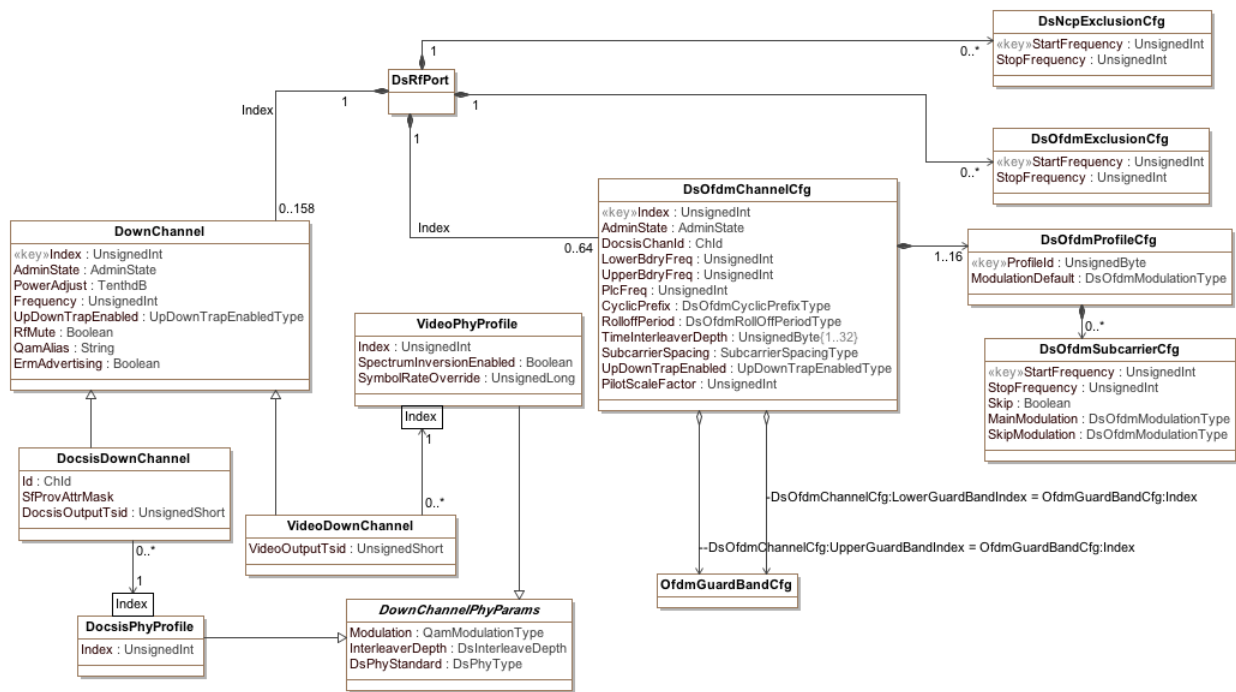

Figure 6-14 - Downstream DOCSIS and Video Configuration Objects<sup>42</sup>

<sup>42</sup> Modified per CCAP-OSSv3.1-N-15.1325-2 and CCAP-OSSv3.1-N-15.1349-3 on 8/13/15 by KB; per CCAP-OSSv3.1-N-16.1440-3 on 5/13/16 by KB.

6.6.6.9.1 *DownChannel*<sup>43</sup>

The DownChannel object contains the attributes used when configuring a QAM channel. This object is contained within a DsRfPort.

A DsRfPort contains a number of configured DownChannel objects. A DownChannel is either a VideoDownChannel or a DocsisDownChannel. The PHY parameters for a down channel are specified by associating a down channel with a PHY profile, either a VideoPhyProfile or DocsisPhyProfile, depending on the down channel type. If a PHY profile is not specified, the CCAP will provide vendor-specific PHY defaults. A DownChannel is a generalization of either a VideoDownChannel or a DocsisDownChannel.

If a Down Channel instance is managed by an ERM, it will contain ERM parameters.

**Table 6-162 - DownChannel Object Attributes**

Attribute Name	Type	Required Attribute	Type Constraints	Units	Default Value
Index	UnsignedInt	Yes (Key)	0..158		
AdminState	AdminState	No			down
UpDownTrapEnabled	UpDownTrapEnabled	No			true
PowerAdjust	TenthdB	No		TenthdB	0
Frequency	UnsignedInt	Yes		Hertz	
RfMute	Boolean	No			false
QamAlias	String	See attribute description			""
ErmAdvertising	Boolean	Yes			

**Table 6-163 - DownChannel Object Associations**

Associated Object Name	Type	Near-end Multiplicity	Far-end Multiplicity	Label
ErmParams	Directed composition to ErmParams		0..1	

6.6.6.9.1.1 DownChannel Object Attributes

**6.6.6.9.1.1.1 Index**

This key identifies a downstream channel on a specific downstream RF Port.

**6.6.6.9.1.1.2 AdminState**

This attribute represents the administrative status of the channel. Setting the value to down(3) results in the channel being muted. The value of testing(4) is used to generate a continuous test wave on this QAM channel.

**6.6.6.9.1.1.3 UpDownTrapEnabled**

This attribute configures whether linkUp/linkDown traps are enabled for this channel.

**6.6.6.9.1.1.4 PowerAdjust**

This attribute represents the power gain for the channel. It is expressed in TenthdB.

**6.6.6.9.1.1.5 Frequency**

This attribute specifies the center frequency of the channel. It is expressed in Hertz. The CCAP MUST reject the configuration of a DownChannel instance that overlaps in frequency with another DownChannel instance on the same downstream RF port.

<sup>43</sup> Section and table modified by CCAP-OSSv3.1-N-15.1349-3 on 8/13/15 by KB.

#### 6.6.6.9.1.1.6 RfMute

This attribute configures the mute state for the specific DownChannel. If set to true, the ifOperStatus of the VideoDownChannel or DocsisDownChannel associated with this instance of DownChannel is set to "down". If set to false, no muting takes place. Operation while muted is described in [DRFI].

#### 6.6.6.9.1.1.7 QamAlias<sup>44</sup>

This attribute represents the name of the QAM channel and is equivalent to the ifAlias object in the IF-MIB [RFC 4546]. A value for this attribute is required for DownChannels that are advertised to an ERM. Advertised channels are reported to the ERM via the [RMI-SDR] interface.

#### 6.6.6.9.1.1.8 ErmAdvertising

This attribute represents the ERRP/ERM advertisement state of the QAM channel. If set to true, the QAM channel is advertised; otherwise it is not advertised. For ERRP, this is primarily useful when statically configuring the QAM channels and when the QAM channel is not made part of the ERM channel list. This attribute is optional for DocsisDownChannel.

#### 6.6.6.9.1.2 ERM Management of DownChannel Instances<sup>45</sup>

A CCAP that supports the Resource Management Interfaces (RMI) will support the following types of video down channels:

- **Dynamically Managed:** The VideoDownChannel instance is configured with an empty output transport stream and is dynamically managed by the ERM. These channels are advertised to the ERM and the ERM uses the ERM-EDGE interface to setup video sessions.
- **UDP Port Mapped:** The VideoDownChannel instance is configured with an output transport stream and VideoSessions that are statically mapped to a UDP port via a StaticUdpMap object instance. The CCAP listens on the configured UDP ports for narrowcast content and multiplexes packets received onto the appropriate VideoSession output transport stream on a VideoDownChannel instance. These channels are advertised to the ERM, but since they are statically provisioned, the ERM does not actively manage the channel.
- **Statically Configured:** The VideoDownChannel instance is configured with SPTS and MPTS program streams that make up linear broadcast content. These channels are not advertised to an ERM.

DownChannel instances in which ErmAdvertising is true are reported by the CCAP to the ERM, as described in [RMI-SDR]. The CCAP identifies a given down channel instance to the ERM by its output TSID and its QAM name (configured in the QamAlias attribute). The CCAP MUST reject the configuration of a VideoDownChannel or a DocsisDownChannel if it is advertised to the ERM but does not have both output TSID and QamAlias configured.

When a change in configuration results in the properties of an advertised down channel instance changing, the CCAP transmits its complete configuration data to the ERM, as specified in [RMI-SDR].

#### 6.6.6.9.1.3 DownChannel Configuration Constraints

The CCAP MUST reject activation of a set of configuration objects that would attempt to enable more than one QAM channel with the same center frequency on any single downstream RF port.

There are two types of QAM in the CCAP device regarding the advertisement to the ERM.

- Pilot QAM that are advertised
- Replicated QAM that are not advertised

In the CCAP configuration model, there are two types of Output TSIDs: VideoOutputTsid, required for all VideoDownChannel instances, and DocsisOutputTsid, an optional attribute of a DocsisDownChannel. The CCAP MAY reject configurations that cause the same Output TSID value to be advertised to the same ERM more than

<sup>44</sup> Modified by CCAP-OSSiv3.1-N-15.1349-3 on 8/13/15 by KB.

<sup>45</sup> Added by CCAP-OSSiv3.1-N-15.1349-3 on 8/13/15 by KB.

once; therefore, exactly one pilot QAM is advertised to the ERM per replication group. If the CCAP allows configurations in which the same output TSID is configured to be advertised to the ERM for multiple down channels, then the CCAP MUST only advertise one of those TSIDs to the ERM as a pilot QAM. The CCAP will use vendor-proprietary rules to decide which QAM to advertise as the pilot in this case.

When a change in configuration results in a replicated QAM transitioning to a pilot QAM, the CCAP MUST advertise the transitioned QAM as a new resource to the ERM.

When a change in configuration results in a pilot QAM transitioning to a replicated QAM, the CCAP MUST notify the ERM and delete the corresponding QAM resource from the ERM. This notification takes place so the sessions can be properly torn down and repositioned.

When advertising the pilot QAM to the ERM, the CCAP MUST include a list all fiber nodes to which it is replicated.

Output TSIDs are unique per DsRfPort. Therefore, when the CCAP replicates a QAM, the CCAP MUST de-advertise that QAM from the ERM.

The CCAP MUST reject configurations of Output TSIDs values that are not unique on a specific DsRfPort.

The CCAP MUST support the configuration of whether or not duplicate Output TSID values are allowed on the CCAP.

#### 6.6.6.9.1.4 Output Replication Requirements

An input transport stream is a sequence of MPEG frames received at a single IP address and UDP port by the CCAP. An input transport stream typically consists of a set of programs that are each identified by an input program number. Each input program consists of a number of elementary streams, each individually identified by a PID. An input transport stream may contain elementary streams that are not part of a program.

A VideoInputTs object configures an input transport stream. A UnicastVideoInputTs object configures a unicast input transport stream; a MulticastVideoInputTs object configures a multicast input transport stream.

An output transport stream is defined as a sequence of MPEG frames transmitted by a CCAP. An output transport stream typically consists of multiple output programs. Each output program consists of a set of elementary streams each identified by an individual PID. An output Multi-Program Transport Stream (MPTS) is an output transport stream that contains tables that identify its programs and associated elementary streams. An output TSID is a 16-bit number that uniquely identifies a MPTS in a streaming zone.

A VideoOutputTs object statically configures a video output transport stream on the CCAP. A VideoOutputTs object is identified with a CCAP-unique Index. A VideoOutputTs object is statically associated with either MptsPassThruSession instances or can be configured as an MPTS that multiplexes several ProgramSession instances and/or PidSession instances. VideoOutputTs instances are only associated with sessions, not directly with video input transport streams. A VideoOutputTs instance is associated with a VideoDownChannel instance, configured with a VideoOutputTsid that is included in its PAT, as transmitted by the CCAP.

A ProgramSession object statically configures the mapping of input transport streams to one or more VideoOutputTs instances. A PidSession object statically configures the mapping of input elementary streams to VideoOutputTs instances. An MptsPassThruSession object statically configures the mapping of an entire input MPTS to VideoOutputTs instances.

It is expected that a given MPTS identified by a unique VideoOutputTs Index can be replicated on more than one CCAP RF port. For example, a narrowcast VOD or SDV MPTS may be transmitted to two, three, or four CCAP downstream RF ports, while digital broadcast video content may be replicated to most or all CCAP downstream RF ports.

A VideoOutputTs instance is statically configured to one or more VideoDownChannel instances via its association to the VideoDownChannel instances in which it will be included. Each VideoDownChannel object represents the contents transmitted on a single RF port at a single frequency. The CCAP MUST replicate the output transport stream represented by a VideoOutputTs object to all of the QAM channels represented by the VideoDownChannel objects to which the VideoOutputTs is associated.

Depending on CCAP vendor implementation, the CCAP MAY transmit the replicated MPEG packets of the multiplexed set of video sessions in exactly the same order.

The CCAP MUST meet all MPEG requirements, per [MPEG], for replicated video sessions.

The CCAP SHOULD allow the configuration of different frequencies and DownChannelPhyParams for different VideoDownChannels to which a VideoOutputTs instance is associated.

The CCAP MAY reject a configuration in which a VideoOutputTs is associated with VideoDownChannel instances that reside on different frequencies.

#### 6.6.6.9.2 *DocsisDownChannel*

The DocsisDownChannel object is a DownChannel used exclusively for DOCSIS. The DownChannel is its generalization.

The DocsisDownChannel object is a specialization of DownChannel.

Some CCAP implementations may implement the association of non-primary capable downstream channels with MAC domain indirectly, based on RF plant topology configuration. In such a case, CCAP device may ignore configuration settings communicated through the label Non-PrimaryCapableDs. If a DocsisDownChannel is not associated with a DocsisPhyProfile instance, the CCAP provides vendor-specific PHY defaults.

**Table 6-164 - DocsisDownChannel Object Attributes**

Attribute Name	Type	Required Attribute	Type Constraints	Units	Default Value
Id	ChId	Yes	0..255		
SfProvAttrMask	AttributeMask	Yes			
DocsisOutputTsid	UnsignedShort	No			0

**Table 6-165 - DocsisDownChannel Object Associations**

Associated Object Name	Type	Near-end Multiplicity	Far-end Multiplicity	Label
DownChannel	Specialization of DownChannel			
DocsisPhyProfile	Directed association to DocsisPhyProfile	0..*	1	DocsisPhyProfileIndex

#### 6.6.6.9.2.1 DocsisDownChannel Object Attributes

##### 6.6.6.9.2.1.1 Id

Unique identifier for the DocsisDownChannel. A value of 0 (zero) means that the CCAP will automatically assign the Id.

##### 6.6.6.9.2.1.2 SfProvAttrMask

This attribute contains Provisioned Attribute Mask of non-bonded service flow assignment to this channel.

##### 6.6.6.9.2.1.3 DocsisOutputTsid

This attribute specifies the optional output TSID of the channel. The TSID is globally unique per CCAP. Replicated output streams share the same Output TSID.

6.6.6.9.3 *VideoDownChannel*

The VideoDownChannel object is a DownChannel used exclusively for video channel configuration. If a VideoDownChannel is not associated with an instance of VideoPhyProfile, the CCAP provides vendor-specific defaults.

**Table 6-166 - VideoDownChannel Object Attributes**

Attribute Name	Type	Required Attribute	Type Constraints	Units	Default Value
VideoOutputTsid	UnsignedShort	Yes			

**Table 6-167 - VideoDownChannel Object Associations**

Associated Object Name	Type	Near-end Multiplicity	Far-end Multiplicity	Label
DownChannel	Specialization of DownChannel			
VideoPhyProfile	Directed association to VideoPhyProfile	0..*	1	VideoPhyProfileIndex

6.6.6.9.3.1 VideoDownChannel Object Attributes

**6.6.6.9.3.1.1 VideoOutputTsid**

This attribute specifies the output TSID of the channel and is required for a VideoDownChannel. The TSID is globally unique per CCAP. Replicated output streams share the same Output TSID.

6.6.6.9.4 *DocsisPhyProfile*

The DocsisPhyProfile object is a specialization of the DownChannelPhyParams object and allows PHY parameters to be specified for a DocsisDownChannel instance.

**Table 6-168 - DocsisPhyProfile Object Attributes**

Attribute Name	Type	Required Attribute	Type Constraints	Units	Default Value
Index	UnsignedInt	Yes			

**Table 6-169 - DocsisPhyProfile Object Associations**

Associated Object Name	Type	Near-end Multiplicity	Far-end Multiplicity	Label
DownChannelPhyParams	Specialization of DownChannelPhyParams			

6.6.6.9.4.1 DocsisPhyProfile Object Attributes

**6.6.6.9.4.1.1 Index**

This attributes specifies a unique index for this instance of DocsisPhyProfile.

6.6.6.9.5 *VideoPhyProfile*

The VideoPhyProfile object is a specialization of the DownChannelPhyParams object and allows PHY parameters to be specified for a VideoDownChannel instance.



**Table 6-170 - VideoPhyProfile Object Attributes**

Attribute Name	Type	Required Attribute	Type Constraints	Units	Default Value
Index	UnsignedInt	Yes			
SpectrumInversionEnabled	Boolean	No			false
SymbolRateOverride	UnsignedLong	No		Symbols per second	

**Table 6-171 - VideoPhyProfile Object Associations**

Associated Object Name	Type	Near-end Multiplicity	Far-end Multiplicity	Units	Default Value
DownChannelPhyParams	Specialization of DownChannelPhyParams				

#### 6.6.6.9.5.1 VideoPhyProfile Object Attributes

##### 6.6.6.9.5.1.1 Index

This attribute specifies a unique index for this instance of VideoPhyProfile.

##### 6.6.6.9.5.1.2 SpectrumInversion

This attribute specifies RF Signal Spectrum inversion. When set to true, it indicates that the QAM channel spectrum is inverted.

##### 6.6.6.9.5.1.3 SymbolRateOverride

This attribute allows the default symbol rate for the VideoPhyProfile to be overridden, expressed in symbols per second. If not specified, channels configured to use this VideoPhyProfile operate with the value specified by DOCSIS for the Annex and modulation.

#### 6.6.6.9.6 DownChannelPhyParams

DownChannelPhyParams is an abstract object that can be used to specify the physical attributes of an SC-QAM DownChannel.

**Table 6-172 - DownChannelPhyParams Object Attributes**

Attribute Name	Type	Required Attribute	Type Constraints	Units	Default Value
Modulation	Enum	No	other(1), qam64(2), qam128(3), qam256(4), qam512(5), qam1024(6)		qam256
InterleaverDepth	Enum	No	other(1), fec18J16(2), fec12J17(3), fec16J8(4), fec32J4(5), fec64J2(6), fec128J1(7), fec128J2(8), fec128J3(9), fec128J4(10), fec128J5(11), fec128J6(12), fec128J7(13), fec128J8(14)		fec128J1

Attribute Name	Type	Required Attribute	Type Constraints	Units	Default Value
DsPhyStandard	Enum	No	other (1), dvbc(2), j83annexB(3), j83annexC(4)		j83annexB

6.6.6.9.6.1 DownChannelPhyParams Object Attributes

6.6.6.9.6.1.1 Modulation

Defines the modulation type used. The value of other(1) is used when a vendor-extension has been implemented for this attribute.

6.6.6.9.6.1.2 InterleaverDepth

This attribute represents the interleaving depth or operation mode of the interleaver. The value of other(1) is used when a vendor-extension has been implemented for this attribute.

This attribute is ignored when DsPhyStandard has a value other than j83annexB(3).

6.6.6.9.6.1.3 DsPhyStandard

This attribute specifies the standard supported by the QAM channel. A value of dvbc(2) corresponds to J.83 Annex A. The value of other(1) is used when a vendor-extension has been implemented for this attribute.<sup>46</sup>

6.6.6.9.7 DsOfdmChannelCfg

This object defines the downstream OFDM channel table. OFDM channels only carry DOCSIS traffic; they cannot be used to carry EQAM video traffic. The downstream OFDM channel bandwidth can be any value from 24 MHz to 192 MHz. Smaller bandwidths than 192 MHz are achieved by nulling subcarriers prior to the IDFT, i.e., by adjusting the equivalent number of active subcarriers while maintaining the same subcarrier spacing of 25 kHz or 50 kHz.

The CCAP can be configured for up to 16 distinct data profiles and one NCP profile. If the CCAP does not support automatic configuration of the NCP modulation profile and profile 0, the CCAP MUST reject the configuration if the NCP modulation profile is not configured, or if profile 0 (aka profile A) is not configured.<sup>47</sup>

If no lower or upper guard band is associated with the channel, then the width of that guard band for the channel will be automatically configured by the CCAP.

Table 6-173 - DsOfdmChannelCfg Object Attributes<sup>48</sup>

Attribute Name	Type	Required Attribute	Type Constraints	Units	Default Value
Index	UnsignedInt	Key			
AdminState	AdminState	No			Down(2)
DocsisChanId	ChId	No			0
LowerBdryFreq	UnsignedInt	Yes	108000000..1770000000	Hz	
UpperBdryFreq	UnsignedInt	Yes	132000000..1794000000	Hz	
PlcFreq	UnsignedInt	Yes	108000000..1770000000	Hz	
CyclicPrefix	DsOfdmCyclicPrefixType	Yes		samples	
RolloffPeriod	DsOfdmWindowingType	Yes		samples	

<sup>46</sup> This attribute only applies to SC-QAM downstream channels, thus there is no value to represent OFDM channels.

<sup>47</sup> Modified per CCAP-OSSv3.1-N-15.1325-2 on 8/11/15 by KB.

<sup>48</sup> Modified per CCAP-OSSv3.1-N-15.1307-3 on 6/1/15 by KB; CCAP-OSSv3.1-N-15.1325-2 on 8/11/15 by KB; per CCAP-OSSv3.1-N-16.1424-1 on 5/13/16 by KB; per CCAP-OSSv3.1-N-16.1440-3 on 5/13/16 by KB.

Attribute Name	Type	Required Attribute	Type Constraints	Units	Default Value
TimeInterleaverDepth	UnsignedByte	Yes	1..16   1..32	OFDM Symbols	
SubcarrierSpacing	Enum	Yes		Hz	
UpDownTrapEnabled	UpDownTrapEnabled	Yes			
PilotScaleFactor	UnsignedInt	No	48..120		48

**Table 6-174 - DsOfdmChannelCfg Object Associations<sup>49</sup>**

Associated Object Name	Type	Near-end Multiplicity	Far-end Multiplicity	Label
DsOfdmProfileCfg	Directed composition to DsOfdmProfileCfg		1..16	
OfdmGuardBandCfg (see note below)	Directed aggregation to OfdmGuardBandCfg	0..*	1	DsOfdm ChannelCfg: LowerGuard BandIndex = OfdmGuard BandCfg:Index
OfdmGuardBandCfg (see note below)	Directed aggregation to OfdmGuardBandCfg	0..*	1	DsOfdm ChannelCfg: UpperGuard BandIndex = OfdmGuard BandCfg:Index

Note: If there is no association to an OfdmGuardBandCfg object, the CCAP MUST calculate the appropriate guard band configuration for that channel.

#### 6.6.6.9.7.1 DsOfdmChannelCfg Object Attributes<sup>50</sup>

##### 6.6.6.9.7.1.1 Index

This attribute represents the unique index of the OFDM Downstream channel. It provides a key into the table.

##### 6.6.6.9.7.1.2 AdminState

This attribute represents the admin state for the OFDM downstream channel.

##### 6.6.6.9.7.1.3 DocsisChanId

This attribute represents the CMTS identification of the downstream channel within this particular MAC interface. Setting this value to 0 instructs the CCAP to automatically assign the channel identifier.

##### 6.6.6.9.7.1.4 LowerBdryFreq<sup>51</sup>

This attribute defines either the lower boundary frequency of the lower guard band or (if no guard band is defined) the lower boundary frequency of the lowest active subcarrier of the OFDM downstream channel. It is intended to be aligned with the boundaries of the SC-QAM channels on defined channel frequency HFC plants. For example, for a 6 MHz plant, the boundary of a channel could be located 3 MHz away from the center frequency of a single carrier channel.

This attribute may not correspond to subcarrier frequency requirements. The CCAP may round this number up to align to subcarrier assignments for the channel.

##### 6.6.6.9.7.1.5 UpperBdryFreq<sup>52</sup>

This attribute defines either the upper boundary frequency of the upper guard band or (if no guard band is defined) the upper boundary frequency of the highest active subcarrier of the OFDM downstream channel. It is intended to be

<sup>49</sup> Table note added per CCAP-OSSiv3.1-N-14.1225-1 on 1/8/15 by KB.

<sup>50</sup> Modified per CCAP-OSSiv3.1-N-15.1325-2 on 8/11/15 by KB.

<sup>51</sup> Modified per CCAP-OSSiv3.1-N-15.1307-3 on 6/1/15 by KB.

<sup>52</sup> Modified per CCAP-OSSiv3.1-N-15.1307-3 on 6/1/15 by KB.

aligned with the boundaries of the SC-QAM channels on defined channel frequency HFC plants. For example, for a 6 MHz plant, the boundary of a channel could be located 3 MHz away from the center frequency of a single carrier channel.

This attribute may not correspond to subcarrier frequency requirements. The CCAP may round this number up to align to subcarrier assignments for the channel.

#### **6.6.6.9.7.1.6 PlcFreq**

This attribute represents the PHY Link Channel (PLC) frequency. It is the center frequency of the lowest subcarrier of the 6 MHz encompassed spectrum containing the PLC at its center. The frequency of this subcarrier is required to be located on a 1 MHz grid. The aim of the PLC is for the CMTS to convey to the CM the physical properties of the OFDM channel.

#### **6.6.6.9.7.1.7 CyclicPrefix**

This attribute represents the Cyclic prefix, which enables the receiver to overcome the effects of inter-symbol-interference and intercarrier-interference caused by micro-reflections in the channel. There are five possible values for the CP and the choice depends on the delay spread of the channel - a longer delay spread requires a longer cyclic prefix. The cyclic prefix is expressed in samples, using the sample rate of 204.8 Msamples/s and is an integer multiple of:  $1/64 * 20 \mu\text{s}$ .

#### **6.6.6.9.7.1.8 RolloffPeriod**

This attribute represents the roll off period or windowing which maximizes channel capacity by sharpening the edges of the spectrum of the OFDM signal. For windowing purposes another segment at the start of the IDFT output is appended to the end of the IDFT output -the roll-off postfix (RP). There are five possible values for the RP, and the choice depends on the bandwidth of the channel and the number of exclusion bands within the channel. A larger RP provides sharper edges in the spectrum of the OFDM signal; however, there is a time vs. frequency trade-off. Larger RP values reduce the efficiency of transmission in the time domain, but because the spectral edges are sharper, more useful subcarriers appear in the frequency domain. There is an optimum value for the RP that maximizes capacity for a given bandwidth and/or exclusion band scenario. The CCAP MUST reject configurations where the roll-off period is greater than the cyclic prefix.

#### **6.6.6.9.7.1.9 TimeInterleaverDepth<sup>53</sup>**

This attribute represents the depth of the time interleaver for the OFDM downstream channel expressed as a number of symbol durations. The value ranges from one and is limited to 16 symbol duration for 25 kHz SubcarrierSpacing and to 32 symbol durations for 50 kHz SubcarrierSpacing, respectively.

#### **6.6.6.9.7.1.10 SubcarrierSpacing**

This attribute defines the subcarrier spacing configured on the OFDM downstream channel. If the SubcarrierSpacing is 50 kHz, then the FFT length is 4K. If the SubcarrierSpacing is 25 kHz, then the FFT length is 8K.

#### **6.6.6.9.7.1.11 UpDownTrapEnabled**

This attribute indicates if a trap should be sent when the Channel transitions from up to down and down to up.

#### **6.6.6.9.7.1.12 PilotScaleFactor**

This attribute indicates the scale factor for calculating the number of continuous pilots.

### **6.6.6.9.8 DsOfdmProfileCfg**

This object defines the OFDM Channel Profile Table. DOCSIS 3.1 introduces the concept of downstream profiles for OFDM channels. A profile is a list of modulation orders that are defined for each of the subcarriers within an OFDM channel. The CMTS can define multiple profiles for use in an OFDM channel, where the profiles differ in

<sup>53</sup> Modified per CCAP-OSSv3.1-N-16.1424-1 on 5/13/16 by KB.

the modulation orders assigned to each subcarrier. It is optional for profiles to be configured via the management system. The CMTS can configure them without management intervention.

**Table 6-175 - DsOfdmProfileCfg Object Attributes**

Attribute Name	Type	Required Attribute	Type Constraints	Units	Default Value
ProfileId	UnsignedByte	Key	0..16   255		
ModulationDefault	DsOfdmModulationType	Yes	None		

**Table 6-176 - DsOfdmProfileCfg Object Associations**

Associated Object Name	Type	Near-end Multiplicity	Far-end Multiplicity	Label
DsOfdmSubcarrierCfg	Directed composition to DsOfdmSubcarrierCfg		0..*	

#### 6.6.6.9.8.1 DsOfdmProfileCfg Object Attributes

##### 6.6.6.9.8.1.1 ProfileId

This attribute is a key defined to provide an index into the table. The NCP profile has an assigned ProfileId of 255.

##### 6.6.6.9.8.1.2 ModulationDefault<sup>54</sup>

This attribute defines the default bit loading applied to subcarriers in the OFDM downstream channel. If a subcarrier is not configured with a specific modulation order, it will use this value. The CCAP MUST reject a modulationDefault value of zeroBitLoaded(2). If ProfileId is 255 (i.e., the NCP profile), the CCAP MUST also reject any modulationDefault values other than qpsk(3), qam16(4), or qam64(5).

#### 6.6.6.9.9 DsOfdmSubcarrierCfg

This object specifies the OFDM Subcarrier Configuration Table. It defines the modulation for a list of subcarriers.

**Table 6-177 - DsOfdmSubcarrierCfg Object Attributes**

Attribute Name	Type	Required Attribute	Type Constraints	Units	Default Value
StartFrequency	UnsignedInt	Key	108000000..1770000000	Hz	
StopFrequency	UnsignedInt	Yes	108000000..1770000000	Hz	
Skip	Boolean	No			false
MainModulation	DsOfdmModulationType	Yes			
SkipModulation	DsOfdmModulationType	No			

#### 6.6.6.9.9.1 DsOfdmSubcarrierCfg Object Attributes<sup>55</sup>

##### 6.6.6.9.9.1.1 StartFrequency

This attribute is a key defined to provide an index into the table and specifies the starting frequency for a range of frequencies allocated for data subcarriers. The CCAP MUST reject a configuration where the start frequency is outside of the channel frequency range.

<sup>54</sup> Modified per CCAP-OSSiv3.1-N-15.1325-2 on 8/11/15 by KB.

<sup>55</sup> Modified per CCAP-OSSiv3.1-N-16.1610-2 on 11/17/16 by KB.

**6.6.6.9.9.1.2 StopFrequency**

This attribute specifies the end frequency of a range of frequencies allocated for data subcarriers. The stop frequency is required to be at least one subcarrier width larger than the start frequency. The CCAP MUST reject a configuration where the stop frequency is outside of the channel frequency range.

**6.6.6.9.9.1.3 Skip**

This attribute indicates if the configuration uses the method of alternating modulation order between subcarriers in the defined range.

**6.6.6.9.9.1.4 MainModulation**

This attribute represents the modulation of the subcarriers. In case of skip modulation enabled, the MainModulation is the modulation order of the first, the third, the fifth, etc., subcarriers in the range.

**6.6.6.9.9.1.5 SkipModulation**

This attribute represents the modulation of every other subcarrier in the defined range.

**6.6.6.9.10 DsOfdmExclusionCfg**

This object specifies the Downstream OFDM Exclusion Configuration Table. This is a global table that lists excluded subcarriers that can be referenced by any Downstream RF Port.

Muted subcarriers are subcarriers that have a value of zero in the bit-loading pattern of a profile.

**Table 6-178 - DsOfdmExclusionCfg Object Attributes**

Attribute Name	Type	Required Attribute	Type Constraints	Units	Default Value
StartFrequency	UnsignedInt	Key	108000000..1794000000	Hz	
StopFrequency	UnsignedInt	Yes	108000000..1794000000	Hz	

**6.6.6.9.10.1 DsOfdmExclusionCfg Object Attributes**

**6.6.6.9.10.1.1 StartFrequency**

This attribute is a key defined to provide an index into the table and specifies the starting frequency of the exclusion entry.

**6.6.6.9.10.1.2 StopFrequency**

This attribute provides the ending frequency for the exclusion entry. The stop frequency is required to be at least one subcarrier width larger than the start frequency.

**6.6.6.9.11 DsNcpExclusionCfg**

This object specifies the Downstream NCP Exclusion Configuration Table. This is a global table that lists excluded subcarriers that can be referenced by any Downstream RF Port.

**Table 6-179 - DsNcpExclusionCfg Object Attributes**

Attribute Name	Type	Required Attribute	Type Constraints	Units	Default Value
StartFrequency	UnsignedInt	Key	108000000..1794000000	Hz	
StopFrequency	UnsignedInt	Yes	108000000..1794000000	Hz	

#### 6.6.6.9.11.1 DsNcpExclusionCfg Object Attributes

##### **6.6.6.9.11.1.1 StartFrequency**

This attribute is a key defined to provide an index into the table and specifies the starting subcarrier frequency of the NCP exclusion entry.

##### **6.6.6.9.11.1.2 StopFrequency**

This attribute provides the ending subcarrier frequency for the NCP exclusion entry.

#### 6.6.6.9.12 *OdfmGuardBandCfg*<sup>56</sup>

This configuration object is included in Figure 6-14. It is defined in Section 6.6.6.1.16.

### **6.6.6.10 DSG Configuration**

The CCAP incorporates the DSG Agent, which is defined as the implementation of the DSG protocol within the CCAP. The DSG Agent creates the DSG Tunnel, places content from the DSG Server into the DSG Tunnel, and sends the DSG Tunnel to the DSG Client.

For CCAP, the DSG Agent configuration object model changes slightly for several tables. The object model for the CCAP is shown in the following class diagram.

---

<sup>56</sup> Added per CCAP-OSSiv3.1-N-16.1440-3 on 5/13/16 by KB.

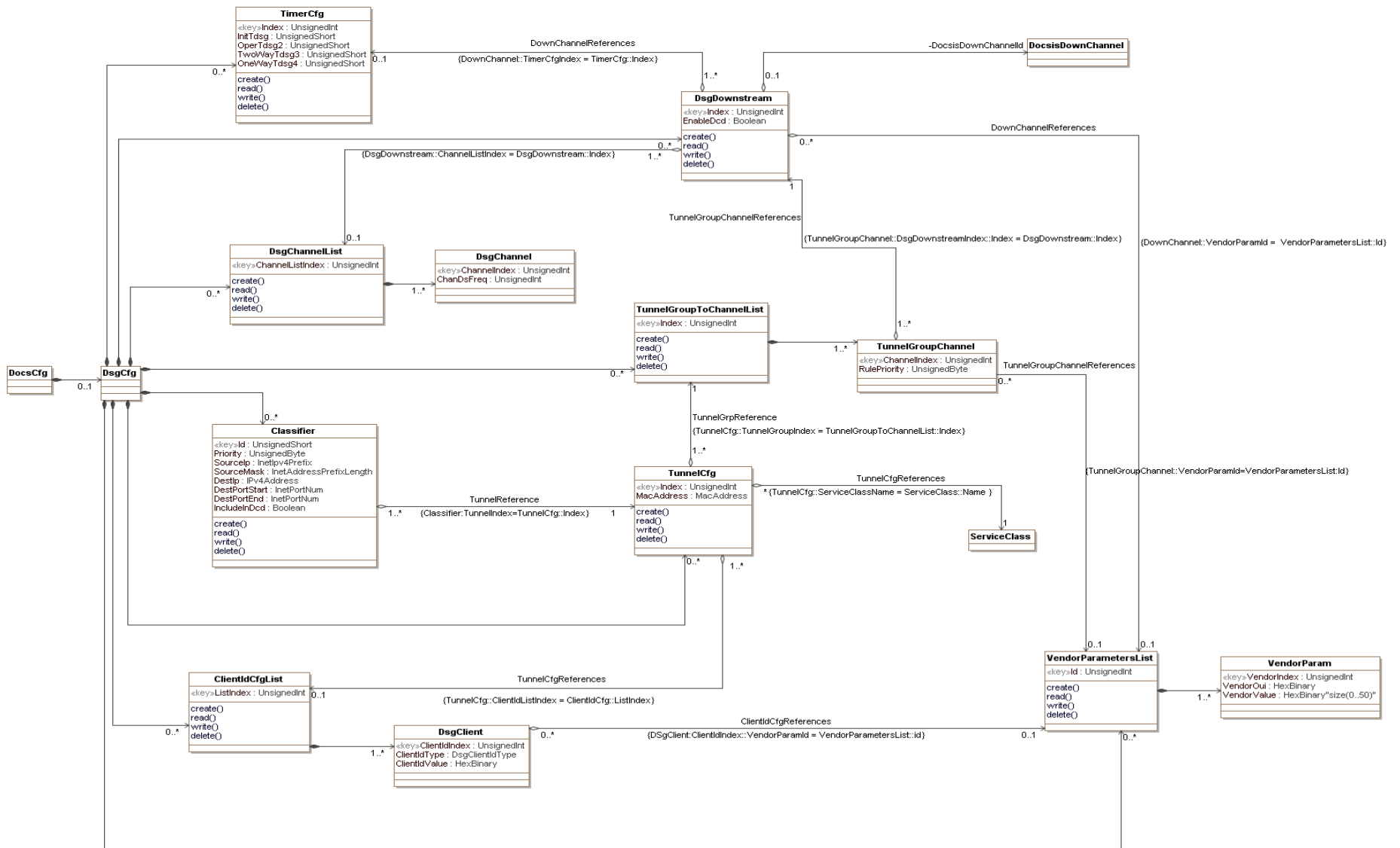

Figure 6-15 - DSG Configuration Objects



### 6.6.6.10.1 DocsCfg

This configuration object is included in Figure 6-15 for reference. It is defined in Section 6.6.6.1.2, DocsCfg.

### 6.6.6.10.2 DsgCfg

The DsgCfg object is the container for DSG configuration objects. It has the following associations:

**Table 6-180 - DsgCfg Object Associations**

Associated Object Name	Type	Near-end Multiplicity	Far-end Multiplicity	Label
TimerCfg	Directed composition to TimerCfg		0..*	
DsgDownstream	Directed composition to DsgDownstream		0..*	
DsgChannelList	Directed composition to DsgChannelList		0..*	
TunnelGroupToChannelList	Directed composition to TunnelGroupToChannelList		0..*	
Classifier	Directed composition to Classifier		0..*	
TunnelCfg	Directed composition to TunnelCfg		0..*	
ClientIdCfgList	Directed composition to ClientIdCfgList		0..*	
VendorParametersList	Directed composition to VendorParametersList		0..*	

### 6.6.6.10.3 TimerCfg

This configuration object is based on the dsgIfTimerTable defined in [DSG] and will be used with modifications for CCAP.

The DSG Timer Table contains timers that are sent to the DSG client(s) via the DCD message.

Reference: [DSG], DOCSIS Set-top Gateway Agent MIB Definition section

**Table 6-181 - TimerCfg Object Attributes**

Attribute Name	Type	Required Attribute	Type Constraints	Units	Default Value
Index	UnsignedInt	Yes (Key)			
InitTdsg	UnsignedShort	No	1..65535	Seconds	2
OperTdsg2	UnsignedShort	No	1..65535	Seconds	600
TwoWayTdsg3	UnsignedShort	No		Seconds	300
OneWayTdsg4	UnsignedShort	No		Seconds	1800

#### 6.6.6.10.3.1 TimerCfg Object Attributes

##### 6.6.6.10.3.1.1 Index

The index for this object.

##### 6.6.6.10.3.1.2 InitTdsg

Initialization Timeout. This is the timeout period in seconds for the DSG packets during initialization of the DSG client. The default value is 2 seconds.

##### 6.6.6.10.3.1.3 OperTdsg2

Operational Timeout. This is the timeout period in seconds for the DSG packets during normal operation of the DSG client. Default value is 600 seconds.

**6.6.6.10.3.1.4 TwoWayTdsg3**

Two-way retry timer. This is the retry timer that determines when the DSG client attempts to reconnect with the DSG Agent and established two-way connectivity. Default value is 300 seconds. The value 0 indicates that the client will continuously retry two-way operation.

**6.6.6.10.3.1.5 OneWayTdsg4**

One-way retry timer. This is the retry timer that determines when the client attempts to rescan for a DOCSIS downstream channel that contains DSG packets after a TimerTdsg1 or TimerTdsg2 timeout. Default value is 1800 seconds. Setting the value to 0 indicates that the client will immediately begin scanning upon TimerTdsg1 or TimerTdsg2 timeout.

*6.6.6.10.4 DsgDownstream*

The DsgDownstream object represents an individual downstream channel for DSG configuration purposes. It has been modified from the DSG Specification definitions.

**Table 6-182 - DsgDownstream Object Attributes**

Attribute Name	Type	Required Attribute	Type Constraints	Units	Default Value
Index	UnsignedInt	Yes (Key)			
EnableDcd	Boolean	Yes			

The DsgDownstream object has the following associations.

**Table 6-183 - DsgDownstream Object Associations**

Associated Object Name	Type	Near-end Multiplicity	Far-end Multiplicity	Label
TimerCfg	Directed aggregation to TimerCfg	1..*	0..1	
DsgChannelList	Directed aggregation to DsgChannelList	1..*	0..1	
DocsisDownChannel	Directed aggregation to DocsisDownChannel	0..1		DocsisDownChannelId
VendorParametersList	Directed aggregation to VendorParametersList	0..*	0..1	

**6.6.6.10.4.1 DsgDownstream Object Attributes**

**6.6.6.10.4.1.1 Index**

This is the key for an instance of this object.

**6.6.6.10.4.1.2 EnabledDcd**

This attribute is used to enable or disable DCD messages to be sent on this downstream channel. The value is always true for those downstreams that contain DSG tunnels.

*6.6.6.10.5 DocsisDownChannel*

This configuration object is included in Figure 6-15 for reference. It is defined in Section 6.6.6.9.2, DocsisDownChannel.

### 6.6.6.10.6 DsgChannelList

This configuration object is based on the `dsgIfChannelListTable` defined in [DSG] and will be used with modifications for CCAP.

The `DsgChannelList` object allows for configuration of a list of one or multiple downstream frequencies that are carrying DSG tunnel(s). This configuration object has been modified from the DSG Specification definitions.

Reference: [DSG], DOCSIS Set-top Gateway Agent MIB Definition section

**Table 6-184 - DsgChannelList Object Attributes**

Attribute Name	Type	Required Attribute	Type Constraints	Units	Default Value
ChanListIndex	UnsignedInt	Yes (Key)			

**Table 6-185 - DsgChannelList Object Associations**

Associated Object Name	Type	Near-end Multiplicity	Far-end Multiplicity	Label
DsgChannel	Directed composition to DsgChannel		1..*	

#### 6.6.6.10.6.1 DsgChannelList Object Attributes

##### 6.6.6.10.6.1.1 ChanListIndex

The index of the down channel list.

### 6.6.6.10.7 DsgChannel

This configuration object allows for one or more downstream frequencies that are carrying DSG tunnel(s) to be associated with a `DsgChannelList`.

**Table 6-186 - DsgChannel Object Attributes**

Attribute Name	Type	Required Attribute	Type Constraints	Units	Default Value
ChannelIndex	UnsignedInt	Yes (Key)			
ChanDsFreq	UnsignedInt	No	0..1000000000	Hz	0

#### 6.6.6.10.7.1 DsgChannel Object Attributes

##### 6.6.6.10.7.1.1 ChannelIndex

The index of the channel.

##### 6.6.6.10.7.1.2 ChanDsFreq

The `ChanDsFreq` attribute represent a frequency of a downstream channel carrying DSG information. Frequency is a multiple of 62500 Hz, per [DSG].

### 6.6.6.10.8 TunnelGroupToChannelList

This configuration object is based on the `dsgIfTunnelGrpToChannelTable` defined in [DSG] and will be used with modifications for CCAP.

The `TunnelGroupToChannelList` object permits association of a group of `DsgDownstream` objects to one or more tunnels. This configuration object has been modified from the DSG Specification definitions.

Reference: [DSG], DOCSIS Set-top Gateway Agent MIB Definition section

**Table 6-187 - TunnelGroupToChannelList Object Attributes**

Attribute Name	Type	Required Attribute	Type Constraints	Units	Default Value
Index	UnsignedInt	Yes (Key)			

The TunnelGrpToChannel object has the following associations.

**Table 6-188 - TunnelGrpToChannel Object Associations**

Associated Object Name	Type	Near-end Multiplicity	Far-end Multiplicity	Label
TunnelGroupChannel	Directed composition to TunnelGroupChannel		1..*	

### 6.6.6.10.8.1 TunnelGroupToChannelList Object Attributes

#### 6.6.6.10.8.1.1 Index

This attribute is the key for this object and allows a link to an instance of a TunnelCfg object be configured.

### 6.6.6.10.9 TunnelGroupChannel

The TunnelGroupChannel object allows DsgDownstream objects to be associated with this group.

**Table 6-189 - TunnelGroupChannel Object Attributes**

Attribute Name	Type	Required Attribute	Type Constraints	Units	Default Value
ChannelIndex	UnsignedInt	Yes (Key)			
RulePriority	UnsignedByte	No	0..255		0

The TunnelGroupChannel object has the following associations.

**Table 6-190 - TunnelGroupChannel Object Associations**

Associated Object Name	Type	Near-end Multiplicity	Far-end Multiplicity	Label
DsgDownstream	Directed aggregation to DsgDownstream	1..*	1	
VendorParametersList	Directed association to VendorParametersList	0..*	0..1	

### 6.6.6.10.9.1 TunnelGroupChannel Object Attributes

#### 6.6.6.10.9.1.1 ChannelIndex

This attribute configures the linkage of a specific DsgDownstream instance to the TunnelCfg instance associated with the group.

#### 6.6.6.10.9.1.2 RulePriority

The DSG rule priority determines the order in which a channel should be applied by the DSG client. The default value is 0, which is the lowest priority.

### 6.6.6.10.10 Classifier

This configuration object is based on the dsgIfClassifierTable defined in [DSG] and will be used with modifications for CCAP.

Reference: [DSG], DOCSIS Set-top Gateway Agent MIB Definition section

**Table 6-191 - Classifier Object Attributes**

Attribute Name	Type	Required Attribute	Type Constraints	Units	Default Value
Id	UnsignedShort	Yes (Key)			
Priority	UnsignedByte	No			0
SourceIp	Ipv4Prefix	Yes			
SourceMask	InetAddressPrefixLength	No			32
DestIp	Ipv4Address	Yes			
DestPortStart	InetAddressPortNum	No			0
DestPortEnd	InetAddressPortNum	No			65535
IncludeInDcd	Boolean	No			true

**Table 6-192 - Classifier Object Associations**

Associated Object Name	Type	Near-end Multiplicity	Far-end Multiplicity	Label
TunnelCfg	Directed aggregation to TunnelCfg	1..*	1	

#### 6.6.6.10.10.1 Classifier Object Attributes

##### 6.6.6.10.10.1.1 Id

This attribute configures the linkage between the DSG tunnel for which this classifier will apply.

##### 6.6.6.10.10.1.2 Priority

This attribute is used to configure the DSG rule priority that determines the order in which a channel and its associated UCIDs should be applied by the DSG client. The default value is 0, which is the lowest priority.

##### 6.6.6.10.10.1.3 SourceIp

This attribute configures the source IP address for the DSG tunnel. Currently, the CCAP only supports IPv4 addresses for DSG tunnels, per [DSG].

##### 6.6.6.10.10.1.4 SourceMask

This attribute configures the source IP address mask for the DSG tunnel.

##### 6.6.6.10.10.1.5 DestIp

This attribute configures the destination IP address for the DSG tunnel. Currently, the CCAP only supports IPv4 addresses for DSG tunnels, per [DSG].

##### 6.6.6.10.10.1.6 DestPortStart

This attribute configures the inclusive lower bound of the transport-layer source port range that is to be matched.

##### 6.6.6.10.10.1.7 DestPortEnd

This attribute configures the inclusive higher bound of the transport-layer source port range that is to be matched.

##### 6.6.6.10.10.1.8 IncludeInDcd

Indicates whether or not this DSG classifier will be sent in DCD messages for use as a Layer-3 and Layer-4 packet filter by the DSG eCM.

6.6.6.10.11 TunnelCfg

A TunnelCfg object allows the operator to configure DSG tunnels. Each DSG Tunnel represents a stream of packets delivered to a DSG Client in a set-top device and is configured with a single destination MAC address.

This configuration object is based on the dsGIfTunnelTable defined in [DSG] and is used with modifications.

Reference: [DSG], DOCSIS Set-top Gateway Agent MIB Definition section

**Table 6-193 - TunnelCfg Object Attributes**

Attribute Name	Type	Required Attribute	Type Constraints	Units	Default Value
Index	UnsignedInt	Yes (Key)			
MacAddress	MacAddress	Yes			

The TunnelCfg object has the following associations.

**Table 6-194 - TunnelCfg Object Associations**

Associated Object Name	Type	Near-end Multiplicity	Far-end Multiplicity	Label
TunnelGroupToChannelList	Directed association to TunnelGroupToChannelList	1..*	1	
ClientIdCfgList	Directed aggregation to ClientIdCfgList	1..*	0..1	
ServiceClass	Directed aggregation to ServiceClass	*	1	

6.6.6.10.11.1 TunnelCfg Object Attributes

**6.6.6.10.11.1.1 Index**

This attribute is the index for a tunnel that could be associated to one or more downstream channels that carry DSG tunnels.

**6.6.6.10.11.1.2 MacAddress**

This attribute configures the DSG tunnel destination MAC address.

**6.6.6.10.11.1.3 ServiceClass**

This configuration object is included in Figure 6-15 for reference. It is defined in Section 6.6.6.4.3, ServiceClass.

6.6.6.10.12 ClientIdCfgList

This configuration object is based on the dsGIfClientIdTable defined in [DSG] and will be used with modifications for CCAP.

The Client Identification object contains a list of client identification types and values. Each entry in the list also contains the vendor-specific parameter identification. There could be multiple client ids associated to a tunnel, grouped by the ListIndex.

Reference: [DSG], DOCSIS Set-top Gateway Agent MIB Definition section

**Table 6-195 - ClientIdCfgList Object Attributes**

Attribute Name	Type	Required Attribute	Type Constraints	Units	Default Value
ListIndex	UnsignedInt	Yes (Key)			

The ClientIdCfgList object has the following associations.

**Table 6-196 - ClientIdCfgList Object Associations**

Associated Object Name	Type	Near-end Multiplicity	Far-end Multiplicity	Label
DsgClient	Directed composition to DsgClient		1..*	

#### 6.6.6.10.12.1 ClientIdCfgList Object Attributes

##### 6.6.6.10.12.1.1 ListIndex

This attribute is the key for the ClientIdCfgList object and provides the unique identifier for each client list.

##### 6.6.6.10.13DsgClient

The DsgClient object represents a list entry in the ClientIdCfgList object.

Reference: [DSG], DOCSIS Set-top Gateway Agent MIB Definition section

**Table 6-197 - DsgClient Object Attributes**

Attribute Name	Type	Required Attribute	Type Constraints	Units	Default Value
ClientIdIndex	UnsignedInt	Yes (Key)			
ClientIdType	Enum	No	other(1), broadcast(2), macAddress(3), caSystemId(4), applicationId(5)		broadcast
ClientIdValue	HexBinary	No	size(6)		'000000000000'h

The DsgClient object has the following associations.

**Table 6-198 - DsgClient Object Associations**

Associated Object Name	Type	Near-end Multiplicity	Far-end Multiplicity	Label
VendorParametersList	Directed aggregation to VendorParametersList	0..*	0..1	

#### 6.6.6.10.13.1 DsgClient Object Attributes

##### 6.6.6.10.13.1.1 ClientIdIndex

This attribute is the key and provides the unique identifier of each DsgClient object in this instance of DsgClient.

##### 6.6.6.10.13.1.2 ClientIdType

The Client Identification type. A DSG client ID of broadcast(2) is received by all DSG clients. A DSG client ID of macAddress(3) is received by the DSG client that has been assigned with this MAC address where the first 3 bytes is the Organization Unique Identifier (OUI). A DSG client ID of caSystemId(4) is received by the DSG client that has been assigned a CA\_system\_ID. A DSG client ID of applicationId(5) is received by the DSG client that has been assigned an application ID. The value of other(1) is used when a vendor-extension has been implemented for this attribute.

##### 6.6.6.10.13.1.3 ClientIdValue

The Client Identification Value. The content depends on the value of the dsgIfClientIdType. For dsgIfClientIdType broadcast(1), this object will have a 16-bit value whether or not it is a length 0 or length 2 broadcast ID. If the value

is 0, then the encoded Type Length Value Attribute (TLV) in the DCD would be the original, zero length, broadcast ID. If the value is specified in table 5-2 of [DSG], then the TLV in the DCD would be a length 2 broadcast ID followed by the value.

For ClientIdType macAddress(2), this object is a well-known MAC address.

For ClientIdType caSystemId(3), this object is a CA System ID.

For ClientIdType applicationId(4), this object is an application ID.

Client IDs representing types broadcast(1), caSystemId(3) or applicationId(4) are encoded in DCD messages as unsigned integers and configured in this object as 6 octet string with the 2 LSB for the client ID value; e.g., an applicationId 2048 (0x0800) is encoded as '000000000800'h.

**6.6.6.10.14 VendorParametersList**

This configuration object is based on the dsgIfVendorParamTable defined in [DSG] and is used with the following modifications for CCAP: a VendorParam object has been created to allow a list of vendor parameters to be associated with this object.

The VendorParametersList object allows vendors to send specific parameters to the DSG clients within a DSG rule or within the DSG Configuration block in a DCD message.

Reference: [DSG], DOCSIS Set-top Gateway Agent MIB Definition section

**Table 6-199 - VendorParametersList Object Associations**

Associated Object Name	Type	Near-end Multiplicity	Far-end Multiplicity	Label
VendorParam	Directed composition to VendorParam		1..*	

**6.6.6.10.15 VendorParam**

This configuration object is based on the dsgIfVendorParamTable defined in [DSG] and holds the attributes that define each vendor parameter.

Reference: [DSG], DOCSIS Set-top Gateway Agent MIB Definition section

**6.6.6.11 PacketCable Configuration Objects**

This section defines the configuration objects needed for configuring PacketCable and PacketCable Multimedia (PCMM) services on the CCAP.



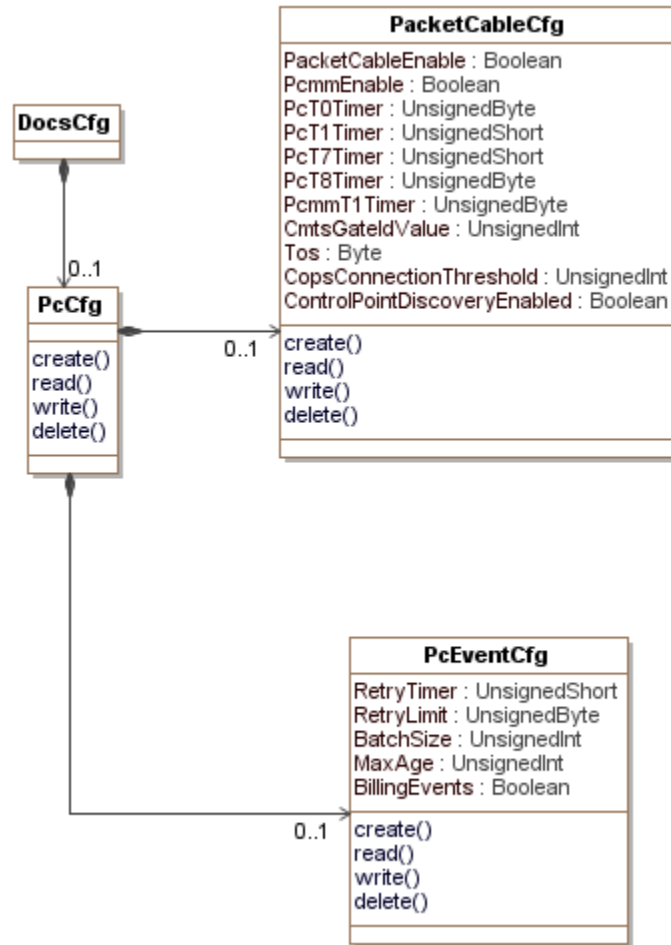

Figure 6-16 - PacketCable Configuration Objects

6.6.6.11.1 DocsCfg

This configuration object is included in Figure 6-16 for reference. It is defined in Section 6.6.6.1.2, DocsCfg.

6.6.6.11.2 PcCfg

The PcCfg object is the container for the PacketCable and PCMM configuration objects. It has the following associations:

Table 6-200 - PcCfg Object Associations

Associated Object Name	Type	Near-end Multiplicity	Far-end Multiplicity	Label
PacketCableConfig	Directed composition from PacketCableConfig		0..1	
PcEventCfg	Directed composition from PcEventCfg		0..1	

6.6.6.11.3 PacketCableConfig Object

This object is used for configuring PacketCable and PCMM services on the CCAP.

**Table 6-201 - PacketCableConfig Object Attributes**

Attribute Name	Type	Required Attribute	Type Constraints	Units	Default Value
PacketCableEnable	Boolean	No			false
PcmmEnable	Boolean	No			false
PcT0Timer	UnsignedByte	No		seconds	30
PcT1Timer	UnsignedShort	No		seconds	200
PcT7Timer	UnsignedShort	No		seconds	200
PcT8Timer	UnsignedByte	No		seconds	0
PcmmT1Timer	UnsignedByte	No		seconds	200
CmtsGateIdValue	UnsignedInt	Yes	0..16383		
Tos	Byte	Yes	-1   0..63		
CopsConnectionThreshold	UnsignedInt	Yes		connections/15 mins	
ControlPointDiscoveryEnabled	Boolean	No			false

### 6.6.6.11.3.1 PacketCableConfig Object Attributes

#### 6.6.6.11.3.1.1 PacketCableEnable

This configuration attribute allows the operator to enable PacketCable services on the CCAP.

#### 6.6.6.11.3.1.2 PcmmEnable

This configuration attribute allows the operator to enable PacketCable Multimedia services on the CCAP.

#### 6.6.6.11.3.1.3 PcT0Timer

This configuration attribute allows the operator to define the value in seconds for the PacketCable T0 timer.

#### 6.6.6.11.3.1.4 PcT1Timer

This configuration attribute allows the operator to define the value in seconds for the PacketCable T1 timer.

#### 6.6.6.11.3.1.5 PcT7Timer

This attribute allows for the setting of the Timeout for Admitted QoS Parameters for the service flow to the value specified for this timer. In the case of a flow with multiple sub-flows, the flow's Timeout for Admitted QoS Parameters is set to the value of timer T7 from the most recently received Gate-Set message for any subflow on the flow. The Timeout for Admitted QoS Parameters limits the period of time that the CMTS holds resources for a service flow's Admitted QoS Parameter Set while they are in excess of its Active QoS Parameter Set.

The recommended default value of this timer is 200 seconds.

#### 6.6.6.11.3.1.6 PcT8Timer

This attribute configures the Timeout for Active QoS Parameters for the service flow to the value specified for this timer. In the case of a flow with multiple sub-flows, the flow's Timeout for Active QoS Parameters is set to the value of timer T8 from the most recently received Gate-Set message for any sub-flow on the flow. The Timeout for Active QoS Parameters limits the period of time resources remain unused on an active service flow.

#### 6.6.6.11.3.1.7 PcmmT1Timer

This configuration attribute allows the operator to define the value in seconds for the PacketCable Multimedia T1 timer.

**6.6.6.11.3.1.8 CmtsGateIdValue**

This configuration attribute allows the operator to define the value for the CMTS ID portion of PCMM GateIds. This value is the 13 least significant bits (0-12) of the GateId.

**6.6.6.11.3.1.9 Tos**

This configuration attribute allows the operator to define the value for the Tos bits in outgoing COPS messages.

**6.6.6.11.3.1.10 CopsConnectionThreshold**

This configuration attribute allows the operator to define the threshold number of COPS connections per 15-minute interval.

**6.6.6.11.3.1.11 ControlPointDiscoveryEnabled**

This attribute enables or disables the Control Point Discovery functionality described in the PacketCable Specifications. The default value is false.

**6.6.6.11.4 PcEventCfg Object**

This object configures event messaging for PacketCable.

**Table 6-202 - PcEventCfg Object Attributes**

Attribute Name	Type	Required Attribute	Type Constraints	Units	Default Value
RetryTimer	UnsignedShort	No	10..10000	milliseconds	3000
RetryLimit	UnsignedByte	No	0..9		3
BatchSize	UnsignedInt	Yes			
MaxAge	UnsignedInt	Yes		seconds	
BillingEvents	Boolean	No			false

**6.6.6.11.4.1 PcEventCfg Object Attributes****6.6.6.11.4.1.1 RetryTimer**

This configuration attribute allows the configuration of the number of seconds the CCAP should wait before sending a message that was not acknowledged.

**6.6.6.11.4.1.2 RetryLimit**

This configuration attribute allows the configuration of the number of times the CCAP should retry before sending a message.

**6.6.6.11.4.1.3 BatchSize**

This configuration attribute allows the configuration of the number of records the CCAP should bundle in a single message to a billing or Record Keeping Server (RKS).

**6.6.6.11.4.1.4 MaxAge**

This object defines the max age of messages to be sent to an RKS or billing server.

**6.6.6.11.4.1.5 BillingEvents**

This attribute tells the CCAP if it needs to send billing events to a billing server/RKS.

### 6.6.6.12 Load Balance Configuration Objects

This section defines the configuration objects needed for configuring DOCSIS load balancing on the CCAP.

The [MULPIv3.1] specification Autonomous Load Balancing section defines two modes of operation for the CMTS to load balance cable modems:

- Autonomous Load Balancing

Autonomous Load Balancing refers to an algorithm implemented at the CMTS whereby the CMTS directly takes actions to manage the distribution of CMs across the available channels. The specifics of the Load Balancing algorithm is left for vendor definition. Cable modems can be provisioned (either by the CM config file, or optionally, by management objects defined here) to be assigned to Restricted Load Balancing Groups, or can be automatically assigned to General Load Balancing Groups (See [MULPIv3.1] General Load Balancing Groups and Restricted Load Balancing Groups sections).

In addition to assignment to a Load Balancing Group, each CM has certain load balancing parameters. The load balancing parameters for a CM can be configured in the CM's configuration file, optionally configured directly in the CMTS, or inherited from the configuration of the Load Balancing Group to which the CM is assigned. The CM load balancing parameters help the CMTS determine which CMs are likely candidates to be balanced across the network, as well as the initialization technique to be used in the balancing operation. The Load Balancing Group defines the service group or list of channels over which the CM is allowed to be balanced within a MAC Domain. The CMTS could also provide load balancing capabilities across MAC Domains. (See [MULPIv3.1] Autonomous Load Balancing section for more details.) The management objects defined here provide a global (CMTS-wide) enable/disable for Autonomous Load Balancing, as well as the ability to enable/disable Autonomous Load Balancing on a Group-by-Group basis.

During Autonomous Load Balancing operations, changes to plant topology, MAC Domain structure, Channel Sets, Load Balancing Groups, etc., could produce unexpected results on those operations. Therefore, it might be advisable or even required by the CMTS implementation for the operator to disable Autonomous Load Balancing prior to making such changes. Moreover, an attempt to enable Load Balancing could be rejected if the CMTS detects configuration issues that would prevent normal Load Balancing operation.

- Externally-Directed Load Balancing

The Externally-Directed Load Balancing operation is performed via a management interface where the operator directs the CMTS to move a particular CM from its current channel configuration to a new channel configuration. Since Externally-Directed Load Balancing has the potential to run at cross-purposes with Autonomous Load Balancing, the CMTS is not required to support Externally-Directed Load Balancing when the Autonomous Load Balancing operation is enabled. The process of externally directing a CM to a different set of channels is also referred to as the "change-over" operation.

There are two types of Load Balancing Groups: Restricted Load Balancing Groups and General Load Balancing Groups. The Restricted Load Balancing Groups are a list of channels where the CM is confined to be balanced by the CMTS. By definition a Restricted Load Balancing Group needs to consist of a subset of channels of a single CM-SG. The General Load Balancing Group comprises all the channels within a MD-CM-SG, and as such there is a one-to-one relationship between General Load Balancing Groups and MD-CM-SGs.

As in DOCSIS 2.0, the Externally-Directed Load Balancing functionality supports single (us & ds) change-over operations (via DCC/UCC) for CMs not operating in Multiple Receive Channel mode. For CMs operating in Multiple Receive Channel mode, the DOCSIS 3.0 CMTS also supports channel-set change-over operations (via DBC or DCC and REG-RSP-MP) (see [MULPIv3.1]).

Another difference in load balancing operation between DOCSIS 2.0 and DOCSIS 3.0 is the interpretation of General and Restricted Load Balancing Groups. In DOCSIS 2.0, General Load Balancing Groups are configured explicitly by the operator. In DOCSIS 3.0, General Load Balancing Groups are generated automatically by the CMTS based on the MD-CM-SGs described in the CMTS topology configuration. In DOCSIS 2.0, the operator configures Restricted Load Balancing Groups either to resolve ambiguous plant topologies (essentially, topologies where the MD-CM-SG cannot be uniquely determined solely by the US/DS channel pair used in Initial Ranging) or

to implement service-related restrictions on the set of channels available to a particular CM (e.g., business vs. residential). In DOCSIS 3.0, the topology resolution algorithm effectively eliminates the first purpose for defining Restricted Load Balancing Groups; operators would then only configure Restricted Load Balancing Groups to effect service-related restrictions. (See [MULPIv3.1]).

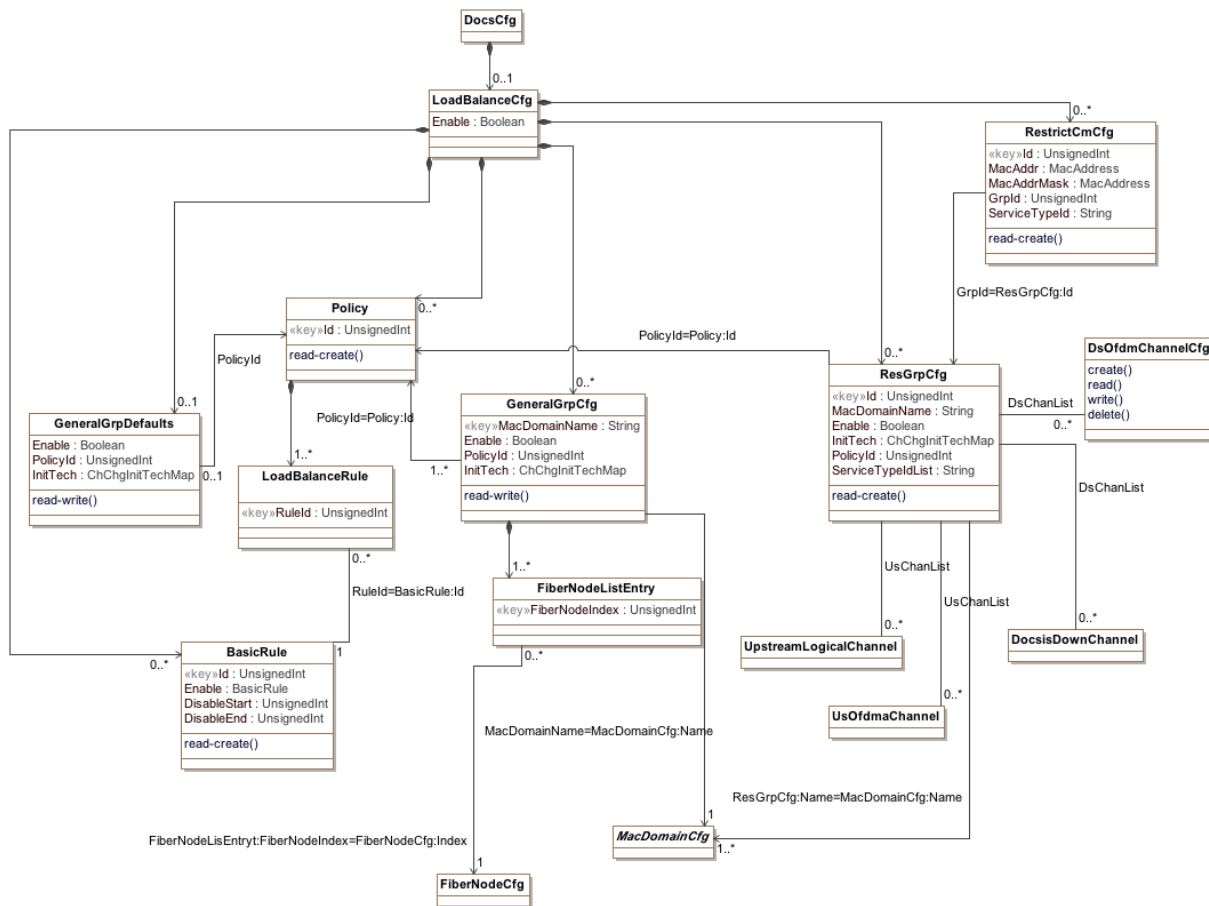

Figure 6-17 - Load Balance Configuration Objects

6.6.6.12.1 DocsCfg

This configuration object is included in Figure 6-16 for reference. It is defined in Section 6.6.6.1.2, DocsCfg.

6.6.6.12.2 LoadBalanceCfg

This object enables and disables Autonomous Load Balancing Operations. It is based on the DOCSIS 3.0 System object and is used with the following modification: The EnableError attribute has been removed because it does not provide enough information about what aspect of the configuration has caused enabling to fail.

Reference: [OSSiv3.0], System Object

Table 6-203 - LoadBalanceCfg Object Attributes

Attribute Name	Type	Required Attribute	Type Constraints	Units	Default Value
Enable	Boolean	No			true

**Table 6-204 - LoadBalanceCfg Object Associations**

Associated Object Name	Type	Near-end Multiplicity	Far-end Multiplicity	Label
GeneralGrpCfg	Directed composition to GeneralGrpCfg		0..*	
GeneralGrpDefaults	Directed composition to GeneralGrpDefaults		0..1	
BasicRule	Directed composition to BasicRule		0..*	
Policy	Directed composition to Policy		0..*	
ResGrpCfg	Directed composition to ResGrpCfg		0..*	
RestrictCmCfg	Directed composition to RestrictCmCfg		0..*	

6.6.6.12.2.1 LoadBalanceCfg Object Attributes

**6.6.6.12.2.1.1 Enable**

This attribute when set to 'true' enables Autonomous Load Balancing operation on the CCAP; otherwise Autonomous Load Balancing is disabled.

When Autonomous Load Balancing is enabled, the CCAP MAY reject Externally-Directed Load Balancing operations. However, even when Autonomous Load Balancing is disabled, the CCAP is required to assign load balancing parameters to CMs as provisioned in the configuration file and/or RestrictCmCfg object.

6.6.6.12.3 GeneralGrpCfg

This object allows configuration of load balancing parameters for General Load Balancing Groups by way of MAC Domain-Fiber Node pairs. In many deployments, a MAC Domain-Fiber Node pair will equate to an MD-CM-SG (which always equates to a GLBG). In the case where an MD-CM-SG spans multiple Fiber Nodes, there will be multiple instances of this object that represent the General Load Balancing Group (MD-CM-SG); the CCAP MUST enforce that such instances all have the same attribute values. Any time a fiber node is associated to a MAC Domain, an instance of this object is defined by the CCAP and populated with either the same values as the other fiber nodes associated with the same MD-CM-SG (if any exist) or default values from the GeneralGrpDefaults object. Similarly, when a fiber node is no longer paired with a MAC Domain, the corresponding instance is deleted from the object.

The CMTS and CCAP MUST persist all instances of the GeneralGrpCfg object across reinitializations.

**Table 6-205 - GeneralGrpCfg Object Attributes**

Attribute Name	Type	Required Attribute	Type Constraints	Units	Default Value
MacDomainName	String	Yes (key)			
Enable	Boolean	No			true
PolicyId	UnsignedInt	No			0
InitTech	EnumBits	No	reinitializeMac(0), broadcastInitRanging(1), unicastInitRanging(2), initRanging(3), direct(4)		

**Table 6-206 - GeneralGroupCfg Object Associations**

Associated Object Name	Type	Near-end Multiplicity	Far-end Multiplicity	Label
Policy	Association to Policy	1..*		PolicyId=Policy:Id
MacDomainCfg	Directed association to MacDomainCfg		1	MacDomainName=MacDomainCfg:Name
FiberNodeListEntry	Directed composition to FiberNodeListEntry		1..*	

### 6.6.6.12.3.1 GeneralGrpCfg Object Attributes

#### 6.6.6.12.3.1.1 MacDomainName

This key configures the MAC Domain being associated with a list of fiber nodes.

#### 6.6.6.12.3.1.2 Enable

This attribute, when set to 'true', enables Autonomous Load Balancing for the General Load Balancing Group associated with this instance. When set to 'false', Autonomous Load Balancing is disabled.

#### 6.6.6.12.3.1.3 PolicyId

This attribute defines the default load balancing policy for the General Load Balancing Group associated with this instance. The value 0 is reserved to indicate no policy is associated with this GeneralGrpCfg instance.

#### 6.6.6.12.3.1.4 InitTech

This attribute defines the load balancing initialization technique for the General Load Balancing Group associated with this instance.

Each bit position represents the internal associated technique as described below:

- reinitializeMac: Reinitialize the MAC.
- broadcastInitRanging: Perform Broadcast initial ranging on new channel before normal operation.
- unicastInitRanging: Perform unicast ranging on new channel before normal operation.
- initRanging: Perform either broadcast or unicast ranging on new channel before normal operation.
- direct: Use the new channel(s) directly without re-initializing or ranging.

Multiple bits can be set to 1 to allow the CCAP to select the most suitable technique in a proprietary manner.

A value with all bits '0' means no channel changes allowed.

References: [MULPIv3.1], Initialization Technique.

### 6.6.6.12.4 FiberNodeListEntry

This object configures an entry in the list of fiber node names that are associated with the configured MAC Domain.

**Table 6-207 - FiberNodeListEntry Object Attributes**

Attribute Name	Type	Required Attribute	Type Constraints	Units	Default Value
FiberNodeIndex	UnsignedInt	Yes (key)			

**Table 6-208 - FiberNodeListEntry Object Associations**

Associated Object Name	Type	Near-end Multiplicity	Far-end Multiplicity	Label
FiberNodeCfg	Directed association to FiberNodeCfg	0..*	1	FiberNodeListEntry: FiberNodeIndex= FiberNodeCfg:Index

### 6.6.6.12.4.1 FiberNodeListEntry Object Attributes

#### 6.6.6.12.4.1.1 FiberNodeIndex

This attribute configures the Index of a FiberNode instance associated with the load balancing group.

### 6.6.6.12.5 GeneralGrpDefaults

This object provides the default load balancing parameters for General Load Balancing Groups (MD-CM-SGs) that are used when instances of GeneralGrpCfg are created by the CCAP.

**Table 6-209 - GeneralGrpDefaults Object Attributes**

Attribute Name	Type	Required Attribute	Type Constraints	Units	Default Value
Enable	Boolean	No			true
PolicyId	UnsignedInt	No			0
InitTech	EnumBits	No	reinitializeMac(0), broadcastInitRanging(1), unicastInitRanging(2), initRanging(3), direct(4)		'F8'H

**Table 6-210 - GeneralGrpDefaults Object Associations**

Associated Object Name	Type	Near-end Multiplicity	Far-end Multiplicity	Label
Policy	Directed association to Policy	0..1		PolicyId

#### 6.6.6.12.5.1 GeneralGrpDefaults Object Attributes

##### 6.6.6.12.5.1.1 Enable

This attribute represents the default value for the Enable attribute of the GeneralGrpCfg object.

##### 6.6.6.12.5.1.2 PolicyId

This attribute represents the default value for the PolicyId attribute of the GeneralGrpCfg object. The value 0 is reserved to indicate no policy is associated with the GeneralGrpDefaults object.

##### 6.6.6.12.5.1.3 InitTech

This attribute represents the default value for the InitTech attribute of the GeneralGrpCfg object.

#### 6.6.6.12.6 BasicRule

This object represents a basic rule set applicable to a load balancing policy that references it.

The CMTS and CCAP MUST persist all instances of BasicRule object across reinitializations.

**Table 6-211 - BasicRule Object Attributes**

Attribute Name	Type	Required Attribute	Type Constraints	Units	Default Value
Id	UnsignedInt	Yes (key)			
Enable	Enum	No	other(1), enabled(2), disabled(3), disabledPeriod(4)		disabled
DisableStart	UnsignedInt	No	0..86399		0
DisableEnd	UnsignedInt	No	0..86399		0



**Table 6-212 - BasicRule Object Associations**

Associated Object Name	Type	Near-end Multiplicity	Far-end Multiplicity	Label
LoadBalanceRule	Association to LoadBalanceRule	1	0..*	RuleId=BasicRule:Id

#### 6.6.6.12.6.1 BasicRule Object Attributes

##### 6.6.6.12.6.1.1 Id

This key configures a unique identifier of a load balancing rule set for this object.

##### 6.6.6.12.6.1.2 Enable

This attribute when set to 'enabled' enables Autonomous Load Balancing (independently of the load balancing group enable/disable state). The rule set is disabled if set to 'disabled'. If set to 'disabledPeriod', the rule set is disabled during a period of time configured in the DisableStart and DisableEnd attributes.

##### 6.6.6.12.6.1.3 DisableStart

This attribute disables load balancing from the time stated by this attribute when the attribute Enable is set to 'disabledPeriod'. The time is defined in seconds since midnight. This attribute is required if the value of the Enable attribute is disabledPeriod; otherwise it is ignored.

##### 6.6.6.12.6.1.4 DisableEnd

This attribute disables load balancing until the time stated by this attribute when the attribute Enable is set to 'disabledPeriod'. The time is defined in seconds since midnight. This attribute is required if the value of the Enable attribute is disabledPeriod; otherwise it is ignored.

#### 6.6.6.12.7 Policy

This object describes the set of load balancing policies. All the rules contained in a load balancing policy apply to Autonomous Load Balancing operations. Load balancing rules are defined within this specification or can be vendor-defined as well.

The CMTS and CCAP MUST persist all instances of Policy object across reinitializations.

**Table 6-213 - Policy Object Attributes**

Attribute Name	Type	Required Attribute	Type Constraints	Units	Default Value
Id	UnsignedInt	Yes (key)	1.. 4294967295		

**Table 6-214 - Policy Object Associations**

Associated Object Name	Type	Near-end Multiplicity	Far-end Multiplicity	Label
LoadBalanceRule	Directed composition to LoadBalanceRule		1..*	

#### 6.6.6.12.7.1 Policy Object Attributes

##### 6.6.6.12.7.1.1 Id

This key configures a unique identifier for this load balancing policy.

6.6.6.12.8 *LoadBalanceRule*

This object allows a load balancing rule to be associated with a Policy instance.

**Table 6-215 - LoadBalanceRule Object Attributes**

Attribute Name	Type	Required Attribute	Type Constraints	Units	Default Value
RuleId	UnsignedInt	Yes (key)			

6.6.6.12.8.1 LoadBalanceRule Object Attributes

**6.6.6.12.8.1.1 RuleId**

This key configures a unique identifier for this instance.

6.6.6.12.9 *ResGrpCfg*

This object represents the configuration of Restricted Load Balancing Groups.

The CMTS and CCAP MUST persist all instances of the ResGrpCfg object across reinitializations.

**Table 6-216 - ResGrpCfg Object Attributes**

Attribute Name	Type	Required Attribute	Type Constraints	Units	Default Value
Id	UnsignedInt	Yes (key)			
MacDomainName	String	Yes			
Enable	Boolean	No			true
InitTech	EnumBits	No	reinitializeMac(0), broadcastInitRanging(1), unicastInitRanging(2), initRanging(3), direct(4)		'F8'H
PolicyId	UnsignedInt	No			0
ServiceTypeList	String	No	0-255		""

**Table 6-217 - ResGrpCfg Object Associations**

Associated Object Name	Type	Near-end Multiplicity	Far-end Multiplicity	Label
Policy	Directed association to Policy	0..1		PolicyId=Policy:Id
UpstreamLogicalChannel	Association to UpstreamLogicalChannel		0..*	UsChanList
DocsisDownChannel	Association to DocsisDownChannel		0..*	DsChanList
MacDomainCfg	Directed association to MacDomainCfg		1..*	ResGrpCfg:Name=MacDomainCfg:Name
UsOfdmaChannel	Association to UsOfdmaChannel		0..*	UsChanList
DsOfdmChannelCfg	Association to DsOfdmChannelCfg		0..*	DsChanList

6.6.6.12.9.1 ResGrpCfg Object Attributes

**6.6.6.12.9.1.1 Id**

This key configures a unique index assigned to the Restricted Load Balancing Group by the user for provisioning purposes. This value is unique within a CCAP and is matched with the CM signaled Load Balancing Group ID TLV value when determining the CM Load Balancing Group assignment based on such TLV value.

References: [MULPIv3.1], Channel Assignment During Registration section.

#### 6.6.6.12.9.1.2 MacDomainName

This attribute configures the MAC domain where the Restricted Load balancing Group applies. A zero length string indicates that vendor-specific mechanisms are used to define the Restricted Load Balancing Group. For example, to provide Load Balancing Groups across MAC domains.

#### 6.6.6.12.9.1.3 Enable

This attribute when set to 'true' enables Autonomous Load Balancing on this Restricted Load Balancing Group. The value 'false' disables the load balancing operation on this group.

#### 6.6.6.12.9.1.4 InitTech

This attribute represents the initialization techniques that the CCAP can use to load balance cable modems in the Load Balancing Group.

Each bit position represents the internal associated technique as described below:

- `reinitializeMac`: Reinitialize the MAC.
- `broadcastInitRanging`: Perform Broadcast initial ranging on new channel before normal operation.
- `unicastInitRanging`: Perform unicast ranging on new channel before normal operation.
- `initRanging`: Perform either broadcast or unicast ranging on new channel before normal operation.
- `direct`: Use the new channel(s) directly without re-initializing or ranging.

By default this object is initialized with all the defined bits having a value of '1'.

Multiple bits can be set to 1 to allow the CCAP to select the most suitable technique in a proprietary manner.

A value with all bits '0' means no channel changes allowed.

References: [MULPIv3.1], Initialization Technique.

#### 6.6.6.12.9.1.5 PolicyId

This attribute represents the default load balancing policy of this Restricted Load Balancing Group. A policy is described by a set of conditions (rules) that govern the load balancing process for a cable modem. The CCAP assigns this Policy ID value to a cable modem associated with the group ID when the cable modem does not signal a Policy ID during registration. The Policy ID value is intended to be a numeric reference to an instance of the Policy object. The Policy ID of value 0 is reserved to indicate no policy is associated with the load balancing group.

#### 6.6.6.12.9.1.6 ServiceTypeIdList

This attribute represent a space separated list of ServiceType IDs that will be compared against the cable modem provisioned Service Type ID to determine the most appropriate Restricted Load Balancing Group.

References: [MULPIv3.1], Channel Assignment During Registration section

#### 6.6.6.12.10 RestrictCmCfg

This object configures a list of cable modems being statically provisioned at the CCAP to a Restricted Load Balancing Group.

**Table 6-218 - RestrictCmCfg Object Attributes**

Attribute Name	Type	Required Attribute	Type Constraints	Units	Default Value
Id	UnsignedInt	Yes (key)			
MacAddr	MacAddress	No			'000000000000'H

Attribute Name	Type	Required Attribute	Type Constraints	Units	Default Value
MacAddrMask	MacAddress	No			
GrpId	UnsignedInt	No			
ServiceTypeId	String	No	0-16		""

**Table 6-219 - RestrictCmCfg Object Associations**

Associated Object Name	Type	Near-end Multiplicity	Far-end Multiplicity	Label
ResGrpCfg	Directed association to ResGrpCfg			GrpId=ResGrpCfg:Id

#### 6.6.6.12.10.1 RestrictCmCfg Object Attributes

##### 6.6.6.12.10.1.1 Id

This key represents the unique identifier of an instance of this object. The CCAP maintains a unique instance per MAC Address/MAC Address Mask combination.

##### 6.6.6.12.10.1.2 MacAddr

This attribute represents the MAC Address of the cable modem within the Restricted Load Balancing Group.

##### 6.6.6.12.10.1.3 MacAddrMask

This attribute corresponds to a bit mask acting as a wild card to associate a cable modem MAC addresses to a Restricted Load Balancing Group ID referenced by a restricted group Id or a Service Type ID. The cable modem matching criteria is performed by bit-ANDed the cable modem MAC address with the MacAddrMask attribute and being compared with the bit-ANDed of attributes MacAddr and MacAddrMask. A cable modem MAC address look up is performed first with instances containing this attribute value not null; if several entries match, the largest consecutive bit match from MSB to LSB is used. Empty value is equivalent to the bit mask all in ones.

##### 6.6.6.12.10.1.4 GrpId

This attribute represents the Restricted Load Balancing Group identifier of this entry associated with the cable modem MAC address - MAC address mask combination. If this attribute is not configured, this instance is matched only against the ServiceTypeId value.

##### 6.6.6.12.10.1.5 ServiceTypeId

This attribute represents the Service Type Id associated with this cable modem MAC address - MAC Address mask combination. If this attribute is not configured, this instance is matched only against the GrpId value; if both GrpId and this attribute are not present, the instance is ignored for matching purposes.

### 6.6.7 CCAP Network Configuration Objects

This section is a collection of configuration objects that are specific to the chassis and not to DOCSIS or video services on a CCAP.

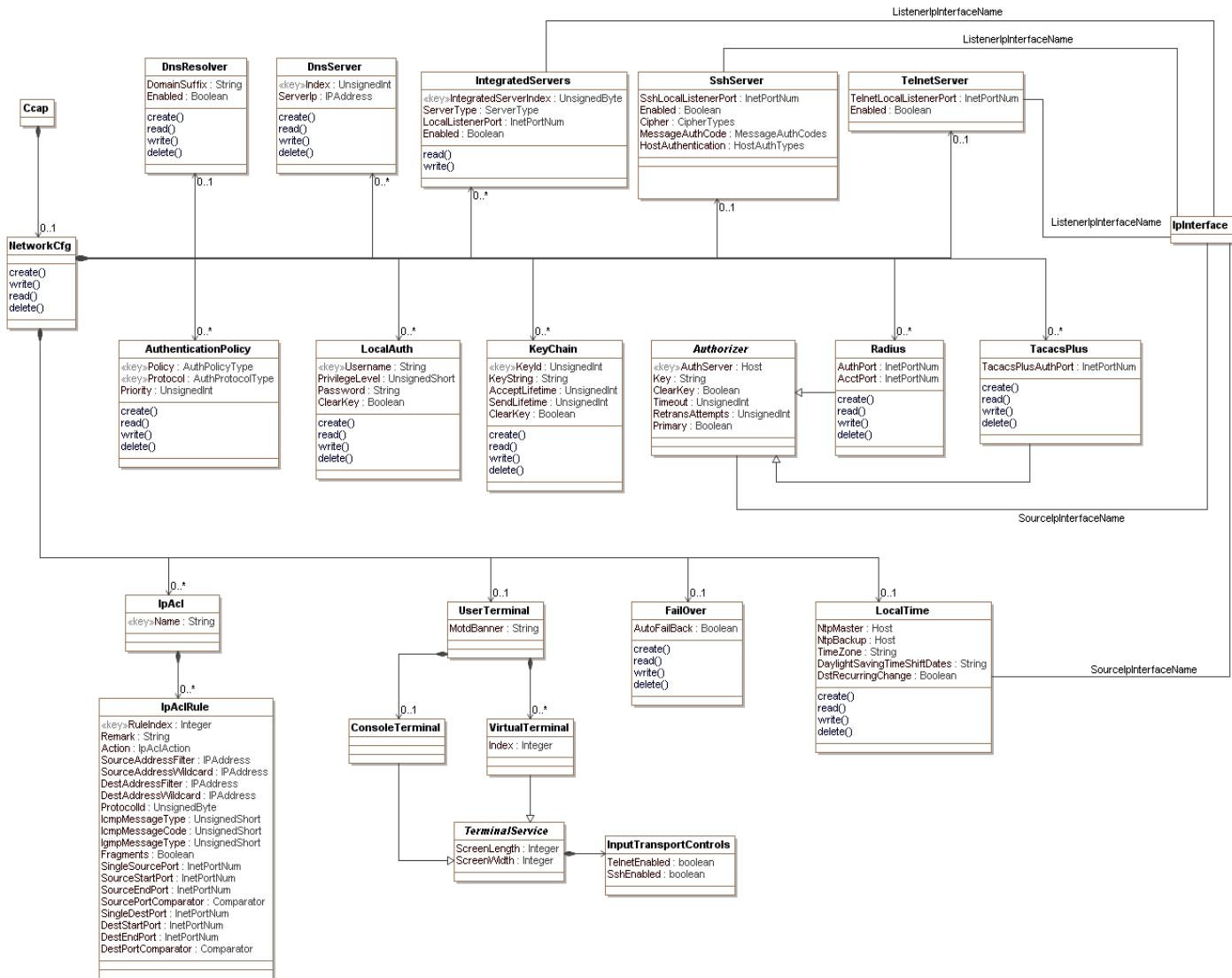

Figure 6-18 - CCAP Network Configuration Objects

#### 6.6.7.1 Ccap

This configuration object is included in Figure 6-18 for reference. It is defined in Section 6.6.3.1, Ccap Object.

#### 6.6.7.2 NetworkCfg

The NetworkCfg object is the primary container of network configuration objects. It has the following associations:

**Table 6-220 - NetworkCfg Object Associations**

Associated Object Name	Type	Near-end Multiplicity	Far-end Multiplicity	Label
DnsResolver	Directed composition to DnsResolver		0..1	
DnsServer	Directed composition to DnsServer		0..*	
IntegratedServers	Directed composition to Integrated Servers		0..*	
SshServer	Directed composition to SshServer		0..1	
TelnetServer	Directed composition to TelnetServer		0..1	
AuthenticationPolicy	Directed composition to AuthenticationPolicy		0..*	
LocalAuth	Directed composition to LocalAuth		0..*	
Radius	Directed composition to Radius		0..*	
TacacsPlus	Directed composition to TacacsPlus		0..*	
KeyChain	Directed composition to KeyChain		0..*	
IpAcl	Directed composition to IpAcl		0..*	
UserTerminal	Directed composition to UserTerminal		0..1	
FailOver	Directed composition to FailOver		0..1	
LocalTime	Directed composition to Time		0..1	

**6.6.7.3 DnsResolver**

This object allows the configuration of DNS servers and the configuration of default domain suffix information. The objects in this configuration object are scalars.

**Table 6-221 - DnsResolver Object Attributes**

Attribute Name	Type	Required Attribute	Type Constraints	Units	Default Value
DomainSuffix	String	Yes			
Enabled	Boolean	No			true

**6.6.7.3.1 DnsResolver Object Attributes**

**6.6.7.3.1.1 DomainSuffix**

The attribute DomainSuffix configures a Domain Suffix that should be post-pended to any hostname lookup that does not consist of a Fully Qualified Domain Name (FQDN).

**6.6.7.3.1.2 Enabled**

This attribute configures if the associated domain suffix should be applied to hostnames that do not include an FQDN.

**6.6.7.4 DnsServer**

This object allows the configuration of the different DNS Servers that the CCAP can use to get Domain Name Resolution.

**Table 6-222 - DnsServer Object Attributes**

Attribute Name	Type	Required Attribute	Type Constraints	Units	Default Value
Index	UnsignedInt	Yes (Key)			
ServerIp	IpAddress	Yes			

#### 6.6.7.4.1 DnsServer Object Attributes

##### 6.6.7.4.1.1 Index

This attribute configures the index for this instance of DnsServer.

##### 6.6.7.4.1.2 ServerIp

This attribute configures the IP address of the DNS server used by the CCAP for DNS resolution. No distinction is made for IPv6 or IPv4 addresses here.

#### 6.6.7.5 IntegratedServers

This configuration object defines the types of servers integrated into the CCAP and their respective administrative states. At run time an object for each server type will be instantiated with its IANA-defined default port; see [PORT NUMS]. To define a different default port, the operator will update the existing IntegratedServers object for that server type with the new port number specified.

**Table 6-223 - IntegratedServers Object Attributes**

Attribute Name	Type	Required Attribute	Type Constraints	Units	Default Value
IntegratedServerIndex	UnsignedByte	Yes (Key)			
ServerType	Enum	Yes	other(1), ftp(2), http(3), netconf(4)		
LocalListenerPort	InetPortNum	No			See attribute description
Enabled	Boolean	No			false

**Table 6-224 - IntegratedServers Object Associations**

Associated Object Name	Type	Near-end Multiplicity	Far-end Multiplicity	Label
IpInterface	Association with an IpInterface			ListenerIpInterfaceName

When an IP interface is selected, this specifies the IP interface on which the server listens. If an IP interface is not specified, the behavior of the CCAP is vendor specific.

#### 6.6.7.5.1 IntegratedServers Object Attributes

##### 6.6.7.5.1.1 IntegratedServerIndex

This attributes configures a unique identifier for this IntegratedServers instance.

##### 6.6.7.5.1.2 ServerType

This attribute configures the type of server being configured on the CCAP. The value of other(1) is used when a vendor-extension has been implemented for this attribute. The CCAP MAY support a NETCONF server-type option.

##### 6.6.7.5.1.3 LocalListenerPort

This attribute configures the TCP or UDP port number on which the server listens. The CCAP MUST assign the default value as the IANA-assigned port number associated with the ServerType selected, as defined in [PORT NUMS].

6.6.7.5.1.4 Enabled

This attribute configures the running state of the server. True means that the server will actively listen on the specified port. False means that the specific server is disabled.

6.6.7.6 SshServer

This configuration object defines an integrated SSHv2 server in the CCAP. The CCAP SSH server MUST support SSH version 2 as defined in:

- [RFC 4250]
- [RFC 4251]
- [RFC 4252]
- [RFC 4253]
- [RFC 4254]

This configuration object allows different combinations of cipher, message authentication code, and host authentication code to be configured; however, a CCAP might not support all possible combinations of these three attributes.

**Table 6-225 - SshServer Object Attributes**

Attribute Name	Type	Required Attribute	Type Constraints	Units	Default Value
SshLocalListenerPort	InetPortNum	No			22
Enabled	Boolean	No			false
Cipher	EnumBits	No	other(0), 3des(1), aes128(2), aes192(3), aes256(4), arcfour(5), blowfish(6), cast(7), twofish128(8), twofish192(9), twofish256(10)		3des
MessageAuthCode	EnumBits	No	other(0), md5(1), md5-96(2), sha1(3), sha1-96(4), ripemd-160(5), sha2-256(6), sha2-512(7)		vendor-specific
HostAuthentication	Enum	No	other(0), none(1), ssh-dss(2), ssh-rsa(3), pgp-sign-rsa(4), pgp-sign-dss(5)		None

**Table 6-226 - SshServer Object Associations**

Associated Object Name	Type	Near-end Multiplicity	Far-end Multiplicity	Label
IpInterface	Association with an IpInterface			ListenerIpInterfaceName



When an IP interface is selected, this specifies the IP interface on which the server listens. If an IP interface is not specified, the behavior of the CCAP is vendor-specific.

#### 6.6.7.6.1 SshServer Object Attributes

##### 6.6.7.6.1.1 LocalListenerPort

This object configures the TCP or UDP port number on which the server listens.

##### 6.6.7.6.1.2 Enabled

This attribute configures the running state of the server. True means that the server will actively listen on the specified port. False means that the specific server is disabled.

##### 6.6.7.6.1.3 Cipher<sup>57</sup>

This attribute configures the set of encryption algorithms that are allowed on the SSH interface. SSH will use the enabled set of algorithms to negotiate the algorithm to use with the connecting client. The CCAP system MUST log an event with severity level "Error" (Event ID:70000110) reporting the configuration file name and unsupported algorithm(s) if the configuration file enables a cipher algorithm that is not supported. The bit setting of "other" can be used to enable an algorithm supported by the CCAP that is not in the defined list.

##### 6.6.7.6.1.4 MessageAuthCode<sup>58</sup>

This attribute configures the set of message authentication algorithms that are allowed on the SSH interface. SSH will use the enabled set of algorithms to negotiate the algorithm to use with the connecting client to ensure message integrity. The CCAP system MUST log an event with severity level "Error" (Event ID: 70000111) reporting the configuration file name and unsupported algorithm(s) if the configuration file enables a MAC algorithm that is not supported. The bit setting of "other" can be used to enable an algorithm supported by the CCAP that is not in the defined list.

##### 6.6.7.6.1.5 HostAuthentication

This attribute enables SSH host authentication using public keys in a specified format. It is assumed that user authentication will be configured in the same way as other CCAP interfaces. The file format for key storage is outside the scope of this specification.

#### 6.6.7.7 TelnetServer

This configuration object defines an integrated Telnet server in the CCAP.

**Table 6-227 - TelnetServer Object Attributes**

Attribute Name	Type	Required Attribute	Type Constraints	Units	Default Value
TelnetLocalListenerPort	InetPortNum	No			23
Enabled	Boolean	No			false

**Table 6-228 - TelnetServer Object Associations**

Associated Object Name	Type	Near-end Multiplicity	Far-end Multiplicity	Label
IpInterface	Association with an IpInterface			ListenerIpInterfaceName

<sup>57</sup> Modified per CCAP-OSSiv3.1-N-16.1499-1 on 5/16/16 by KB.

<sup>58</sup> Modified per CCAP-OSSiv3.1-N-16.1499-1 on 5/16/16 by KB.

When an IP interface is selected, this specifies the IP interface on which the server listens. If an IP interface is not specified, the behavior of the CCAP is vendor-specific.

#### 6.6.7.7.1 *TelnetServer Object Attributes*

##### 6.6.7.7.1.1 LocalListenerPort

This object configures the TCP or UDP port number on which the server listens.

##### 6.6.7.7.1.2 Enabled

This attribute configures the running state of the server. True means that the server will actively listen on the specified port. False means that the specific server is disabled.

#### 6.6.7.8 **AuthenticationPolicy**

This configuration object allows the configuration of authentication policy. The Priority attribute controls which service is used first for authenticating users.

**Table 6-229 - AuthenticationPolicy Object Attributes**

Attribute Name	Type	Required Attribute	Type Constraints	Units	Default Value
Policy	Enum	Yes (Key)	other(1), login(2), privilegedMode(3)		
Protocol	Enum	Yes (Key)	other(1), radius(2), tacacsPlus(3), localAuth(4), none(5)		
Priority	UnsignedInt	Yes			

#### 6.6.7.8.1 *AuthenticationPolicy Object Attributes*

##### 6.6.7.8.1.1 Policy

This attribute is the first part of the key and configures the policy type for the specified protocol. The privilegedMode(3) option is an administrative role that allows the user to execute all available commands. The value of other(1) is used when a vendor-extension has been implemented for this attribute.

##### 6.6.7.8.1.2 Protocol

This attribute is the second part of the key and represents the protocol used for authentication. The value of other(1) is used when a vendor extension has been implemented for this attribute.

##### 6.6.7.8.1.3 Priority

This attribute sets a priority for the protocol selected. Higher numbers are higher priority. A specified policy cannot have the same priority across multiple protocols.

#### 6.6.7.9 **LocalAuth**

This object configures the local user accounts and privilege levels.

**Table 6-230 - LocalAuth Object Attributes**

Attribute Name	Type	Required Attribute	Type Constraints	Units	Default Value
Username	String	Yes (Key)			
PrivilegeLevel	UnsignedShort	Yes	0..15		
Password	String	Yes			
ClearKey	Boolean	Yes			

### 6.6.7.9.1 LocalAuth Object Attributes

#### 6.6.7.9.1.1 UserName

This attribute configures the "login" name to be used.

#### 6.6.7.9.1.2 PrivilegeLevel

This attribute correspond to the user's privilege level. The highest number provides the most user privileges.

#### 6.6.7.9.1.3 Password

This attribute correspond to the user's password. Upon export, the CCAP MUST export the Password attribute of the LocalAuth object encrypted with a vendor-specific algorithm.

#### 6.6.7.9.1.4 ClearKey

This attribute indicates whether the Password attribute is included in the XML configuration file in the clear (true) or encrypted (false). This attribute defines the status of the password (encrypted or decrypted), not whether the device should export the password in the clear or encrypted. Regardless of the value of this setting, the password will always be exported as encrypted.

### 6.6.7.10 Authorizer

The Authorizer abstract class holds common attributes used for configuring TACACS+ and Radius services for the CCAP.

**Table 6-231 - Authorizer Object Attributes**

Attribute Name	Type	Required Attribute	Type Constraints	Units	Default Value
AuthServer	Host	Yes (Key)			
Key	String	Yes			
ClearKey	Boolean	Yes			
Timeout	Byte	No		seconds	3
RetransAttempts	UnsignedByte	No			1
Primary	Boolean	No			false

**Table 6-232 - Authorizer Object Associations**

Associated Object Name	Type	Near-end Multiplicity	Far-end Multiplicity	Label
IpInterface	Association with an IpInterface			SourceIpInterfaceName

This association specifies the IP interface to use as the source interface. If an IP interface is not specified, the behavior of the CCAP is vendor-specific.

6.6.7.10.1 *Authorizer Object Attributes*

6.6.7.10.1.1 AuthServer

This attribute is the IPv4 address or FQDN of the server.

6.6.7.10.1.2 Key

This attribute corresponds to the shared secret that is used to encrypt the communication.

Upon export, the CCAP MUST export the Key attribute of the TacacsPlus object encrypted with a vendor-specific algorithm.

6.6.7.10.1.3 ClearKey

This attribute indicates whether the Key attribute is included in the XML configuration file in the clear (true) or encrypted (false). This attribute defines the status of the key (encrypted or decrypted), not whether the device should export the key in the clear or encrypted. Regardless of the value of this setting, the key will always be exported as encrypted.

6.6.7.10.1.4 Timeout

This attribute defines the number of seconds before a connection is declared inactive.

6.6.7.10.1.5 RetransAttempts

This attribute defines the number of retransmissions before giving up the connection.

6.6.7.10.1.6 Primary

This attribute designates whether this TACACS instance is the primary or backup server.

**6.6.7.11 Radius**

This configuration object creates the configuration for Radius servers.

**Table 6-233 - Radius Object Attributes**

Attribute Name	Type	Required Attribute	Type Constraints	Units	Default Value
AuthPort	InetPortNum	No	0..65535		1812
AcctPort	InetPortNum	No	0..65535		1813

**Table 6-234 - Radius Object Associations**

Associated Object Name	Type	Near-end Multiplicity	Far-end Multiplicity	Label
Authorizer	Specialization of Authorizer			

6.6.7.11.1 *Radius Object Attributes*

6.6.7.11.1.1 AuthPort

This attribute defines the TCP port on which AAA authentication and authorization are performed.

6.6.7.11.1.2 AcctPort

This attribute defines the TCP port on which AAA accounting is performed.

### 6.6.7.12 TacacsPlus

This configuration object configures TACACS+ services for the CCAP.

**Table 6-235 - TacacsPlus Object Attributes**

Attribute Name	Type	Required Attribute	Type Constraints	Units	Default Value
TacacsPlusAuthPort	InetPortNum	No	0..65535		49

**Table 6-236 - TacacsPlus Object Associations**

Associated Object Name	Type	Near-end Multiplicity	Far-end Multiplicity	Label
Authorizer	Specialization of Authorizer			

Specifies the IP interface to use as the source interface. If an IP interface is not specified, the behavior of the CCAP is vendor-specific.

#### 6.6.7.12.1 TacacsPlus Object Attributes

##### 6.6.7.12.1.1 TacacsPlusAuthPort

This attribute defines the TCP port used for communicating with the AAA server.

### 6.6.7.13 KeyChain

The KeyChain object allows the CCAP to be configured with different Ripv2 key change information.

**Table 6-237 - KeyChain Object Attributes**

Attribute Name	Type	Required Attribute	Type Constraints	Units	Default Value
KeyId	UnsignedInt	Yes (Key)	0..2147483647		
KeyString	String	Yes	1..79		
AcceptLifetime	UnsignedInt	Yes	0..2147483647	seconds	
SendLifetime	UnsignedInt	No	0..2147483647	seconds	0
ClearKey	Boolean	Yes			

#### 6.6.7.13.1 KeyChain Object Attributes

##### 6.6.7.13.1.1 KeyId

This attribute configures a KeyId used in RipV2 route updates.

##### 6.6.7.13.1.2 KeyString

This attribute configures the actual key used for this instance. This value has to be the same on both the sender and receiver of the RIPv2 route.

##### 6.6.7.13.1.3 AcceptLifetime

This attribute configures the accept lifetime value in seconds for the key in this instance.

6.6.7.13.1.4 SendLifetime

This attribute configures the send lifetime value in seconds for the key in this instance. A value of 0 (zero) means that there is no lifetime limit.

6.6.7.13.1.5 ClearKey

This attribute indicates whether the KeyString attribute is included in the XML configuration file in the clear (true) or encrypted (false). This attribute defines the status of the key (encrypted or decrypted), not whether the device should export the key in the clear or encrypted. Regardless of the value of this setting, the key will always be exported as encrypted.

**6.6.7.14 IpAcl**

This configuration object defines the attributes for the IP Access Control List object. This object defines an extended access control list.

**Table 6-238 - IpAcl Object Attributes**

Attribute Name	Type	Required Attribute	Type Constraints	Units	Default Value
Name	String	Yes (Key)	1..32		

**Table 6-239 - IpAcl Object Associations**

Associated Object Name	Type	Near-end Multiplicity	Far-end Multiplicity	Label
IpAclRule	Directed composition to IpAclRule		0..*	

6.6.7.14.1 IpAcl Object Attributes

6.6.7.14.1.1 Name

This attribute configures a unique identifier for an instance of this object.

**6.6.7.15 IpAclRule**

This configuration object defines an access control list rule contained within an IpAcl instance. Multiple rules can be contained within an IpAcl instance.

When the ACL rule is processed, the system will only match on the values configured in the rule. If an attribute is not provided in the configuration instance file, the CCAP will match any value for that attribute. For example, if ProtocolId is not specified, then any value for protocol Id in the packet will match the filter. If the CCAP rejects the configuration of an IpAclRule, the CCAP SHOULD also reject the IpAcl instance that contains the rule.

A configured instance of the IpAclRule object either holds a Remark or an Action. If it contains a Remark, then only the RuleIndex and Remark attributes are allowed. If the instance contains and Action, the Remark attribute is not allowed, but all other attributes can be included, as described in the following sections.

**Table 6-240 - IpAclRule Object Attributes**

Attribute Name	Type	Required Attribute	Type Constraints	Units	Default Value
RuleIndex	Integer	Yes (Key)			
Remark	String	No			
Action	Enum	No	other(1), deny(2), permit(3)		
SourceAddressFilter	IpAddress	No <sup>1</sup>			

Attribute Name	Type	Required Attribute	Type Constraints	Units	Default Value
SourceAddressWildcard	IpAddress	No <sup>2</sup>			
DestAddressFilter	IpAddress	No <sup>1</sup>			
DestAddressWildcard	IpAddress	No <sup>3</sup>			
ProtocolId	UnsignedByte	No			
IcmpMessageType	UnsignedShort	No	0..255		
IcmpMessageCode	UnsignedShort	No	0..255		
IgmpMessageType	UnsignedShort	No	0..255		
Fragments	Boolean	No			false
SingleSourcePort	InetPortNum	No			
SourceStartPort	InetPortNum	No			
SourceEndPort	InetPortNum	No			
SourcePortComparator	Enum	No	other(1), lessThan(2), greaterThan(3), equals(4), notEqual(5)		equals(4)
SingleDestPort	InetPortNum	No			
DestStartPort	InetPortNum	No			
DestEndPort	InetPortNum	No			
DestPortComparator	Enum	No	other(1), lessThan(2), greaterThan(3), equals(4), notEqual(5)		equals(4)

## Table Notes:

<sup>1</sup> If an Action is being configured, either SourceAddressFilter or DestAddressFilter is required for the configuration of this object, however both are not required. If an Action is configured and neither the SourceAddressFilter nor the DestAddressFilter value is provided in the configuration instance file, the CCAP MUST reject the configuration of the IpAclRule instance.

<sup>2</sup> If a SourceAddressFilter is configured, then the corresponding SourceAddressWildcard attribute also has to be configured.

<sup>3</sup> If a DestAddressFilter is configured, then the corresponding DestAddressWildcard attribute also has to be configured.

### 6.6.7.15.1 IpAclRule Object Attributes

#### 6.6.7.15.1.1 RuleIndex

This attribute configures a unique identifier for the ACL rule. This value also sets the order in which rules are executed, with lower numbers executing first. The CCAP MAY restrict a range of indexes to a specific set of ACL attributes in a vendor-proprietary way.

#### 6.6.7.15.1.2 Remark

This attribute provides a textual string that explains the intent of a group of ACL rules. When the Remark attribute is configured, only the RuleIndex attribute is allowed to be configured within that instance; if additional attributes are configured, the CCAP MUST reject the configuration of the IpAclRule instance.

#### 6.6.7.15.1.3 Action

This attribute configures the action the CCAP takes when the ACL rule matches a packet. This and all of the following attributes are only valid if a Remark attribute has not been configured.

#### 6.6.7.15.1.4 SourceAddressFilter

This attribute defines an IP addresses to match the source address in the packet; it is used in conjunction with the SourceAddressWildcard attribute. The value can be an IPv4 or IPv6 address.

When both source and destination address filters are specified, each configured value has to be of the same IP type (either IPv4 or IPv6). If a DestAddressFilter is also specified, the CCAP MUST reject the IpAclRule configuration if the address types do not match.

#### 6.6.7.15.1.5 SourceAddressWildcard

The SourceAddressWildcard attribute defines which bits of the packet's source IP address are matched to the SourceAddressFilter attribute. The usage of the IP address wildcard differs from most typical applications where IP addresses are masked. Rather than restricting the defined IP address to a range of addresses by masking off the lowest significant bits of the address, the IP address mask is used as a wildcard.

Each bit in the SourceAddressWildcard set to zero indicates that the corresponding bit position in the packet's source IP address needs to exactly match the bit value in the corresponding bit position in the SourceAddressFilter. Each wildcard bit set to one indicates that both a zero bit and a one bit in the corresponding position of the packet's IP address will be considered a match to this access list entry. In other words, "ones" are places in bit positions that should be ignored. The set of "ones" does not have to start at LSB, nor has to cover consecutive bit positions. For example, a value of 0.0.255.1 is valid for an IPv4 wildcard.

For example, to configure the AclRule to match any IPv4 source address, a value of 0.0.0.0 would be configured in the SourceAddressFilter attribute and a value of 255.255.255.255 would be configured in the SourceAddressWildcard attribute.

A value of 0.0.0.0 for SourceAddressWildcard attribute signifies that the IP ACL will match packet to a specific host IP address specified in SourceAddressFilter attribute.

#### 6.6.7.15.1.6 DestAddressFilter

This attribute defines an IP addresses to match the destination address in the packet; it is used in conjunction with the DestAddressWildcard attribute. The value can be an IPv4 or IPv6 address.

When both source and destination address filters are specified, each configured value has to be of the same IP type (either IPv4 or IPv6). If a SourceAddressFilter is also specified, the CCAP MUST reject the IpAclRule configuration if the IP address types do not match.

#### 6.6.7.15.1.7 DestAddressWildcard

The DestAddressWildcard attribute defines which bits of the packet's source IP address are matched to the DestAddressFilter attribute. The usage of the IP address wildcard differs from most typical applications where IP addresses are masked. Rather than restricting the defined IP address to a range of addresses by masking off the lowest significant bits of the address, the IP address mask is used as a wildcard.

The rules for matching are identical to those described for SourceAddressWildcard.

#### 6.6.7.15.1.8 ProtocolId

This attribute defines an IP protocol number for the filter to match when the protocol is not ICMP or IGMP.

If the protocol is ICMP or IGMP, one of the following attributes will be configured instead:

- IcmpMessageType
- IgmppMessageType

#### 6.6.7.15.1.9 IcmpMessageType

This attribute defines the ICMP message type for the filter to match. For the ICMP protocol, the ProtocolId attribute is not used. If both the ProtocolId and IcmpMessageType attributes are provided in an IpAclRule instance, the CCAP MUST reject the configuration of the IpAclRule instance.



#### 6.6.7.15.1.10 IcmpMessageCode

This attribute is only applicable if an IcmpMessageType has been configured. When this attribute is defined, the CCAP will filter packets that match the configured ICMP message type and message code. If the IcmpMessageCode attribute is provided in an IpAclRule instance, but the IcmpMessageType attribute is not, the CCAP MUST reject the configuration of the IpAclRule instance.

#### 6.6.7.15.1.11 IcmpMessageType

This attribute defines the IGMP message type for the filter to match. For the IGMP protocol, the ProtocolId attribute is not used. If both the ProtocolId and IcmpMessageType attributes are provided in an IpAclRule instance, the CCAP MUST reject the configuration of the IpAclRule instance. If both the IcmpMessageType and IcmpMessageCode attributes are provided in an IpAclRule instance, the CCAP MUST reject the configuration of the IpAclRule instance.

#### 6.6.7.15.1.12 Fragments

This attribute determines whether the ACL rule is applied to all fragments of a fragmented packet, or only to the initial fragment. A setting of false means that only the initial fragment is filtered.

#### 6.6.7.15.1.13 SingleSourcePort

This attribute defines a single source port number for the ACL rule. The CCAP will filter a packet that comes from this source port.

For source port filtering, either the SingleSourcePort attribute, or the SourceStartPort and SourceEndPort attributes (i.e., a port range) is configured. If the SingleSourcePort and SourceStartPort attributes are provided in an IpAclRule instance, the CCAP MUST reject the configuration of the IpAclRule instance.

#### 6.6.7.15.1.14 SourceStartPort

This attribute defines the starting source port number for a range of ports defined for the ACL rule. When the SourceStartPort attribute is configured, the SourceEndPort attribute is also required. If the SourceStartPort attribute is provided in an IpAclRule instance, but a SourceEndPort attribute is not, the CCAP MUST reject the configuration of the IpAclRule instance.

#### 6.6.7.15.1.15 SourceEndPort

This attribute defines the ending source port number for a range of ports defined for the ACL rule. The value of this attribute has to be greater than the value in the SourceStartPort. If the SourceEndPort attribute is provided in an IpAclRule instance, but the SourceStartPort is not, the CCAP MUST reject the configuration of the IpAclRule instance.

#### 6.6.7.15.1.16 SourcePortComparator

This attribute defines how the filter matches a specified SingleSourcePort. This attribute is not valid if a SourceStartPort and SourceEndPort are provided. The filter can match if the source port number of the packet is less than, greater than, equal to, or not equal to the defined source port number.

The CCAP MUST support the “less than”, “greater than”, and “not equal to” settings when a SingleSourcePort attribute is provided.

#### 6.6.7.15.1.17 SingleDestPort

This attribute defines a single destination port number for the ACL rule. The CCAP will filter a packet that has this destination port.

For destination port filtering, either the SingleDestPort attribute, or the DestStartPort and DestEndPort attributes (i.e., a port range) are configured. If the SingleDestPort and DestStartPort attributes are provided in an IpAclRule instance, the CCAP MUST reject the configuration of the IpAclRule instance.

6.6.7.15.1.18 DestStartPort

This attribute defines the starting destination port number for a range of ports defined for the ACL rule. When the DestStartPort attribute is configured, the DestEndPort attribute is also required. If the DestStartPort attribute is provided in an IpAclRule instance, but a DestEndPort attribute is not, the CCAP MUST reject the configuration of the IpAclRule instance.

6.6.7.15.1.19 DestEndPort

This attribute defines the ending destination port number for a range of ports defined for the ACL rule. The value of this attribute has to be greater than the value in the DestStartPort. If the DestEndPort attribute is provided in an IpAclRule instance, but the DestStartPort is not, the CCAP MUST reject the configuration of the IpAclRule instance.

6.6.7.15.1.20 DestPortComparator

This attribute defines how the filter matches a specified SingleDestPort. The filter can match if the destination port number of the packet is less than, greater than, equal to, or not equal to the defined destination port.

The CCAP MUST support the “less than”, “greater than”, and “not equal to” settings when a SingleDestPort attribute is provided.

**6.6.7.16 UserTerminal**

This container object configures the user terminal instances for the CCAP, both the ConsoleTerminal instance and VirtualTerminal instances.

**Table 6-241 - UserTerminal Object Attributes**

Attribute Name	Type	Required Attribute	Type Constraints	Units	Default Value
MotdBanner	String	No			""

**Table 6-242 - UserTerminal Object Associations**

Associated Object Name	Type	Near-end Multiplicity	Far-end Multiplicity	Label
TerminalService	Specialization of TerminalService			

6.6.7.16.1 UserTerminal Object Attributes

6.6.7.16.1.1 MotdBanner

This attribute configures the contents of a message of the day banner that displays to the user when the user logs into a virtual terminal.

**6.6.7.17 VirtualTerminal**

This object configures a virtual terminal interface on the CCAP.

**Table 6-243 - VirtualTerminal Object Attributes**

Attribute Name	Type	Required Attribute	Type Constraints	Units	Default Value
Index	Integer	Yes			

**Table 6-244 - VirtualTerminal Object Associations**

Associated Object Name	Type	Near-end Multiplicity	Far-end Multiplicity	Label
TerminalService	Specialization of TerminalService			

**6.6.7.17.1 VirtualTerminal Object Attributes****6.6.7.17.1.1 Index**

This attribute configures a unique index for this virtual terminal instance.

**6.6.7.18 ConsoleTerminal**

This object configures the console terminal interface on the CCAP.

**Table 6-245 - ConsoleTerminal Object Associations**

Associated Object Name	Type	Near-end Multiplicity	Far-end Multiplicity	Label
TerminalService	Specialization of TerminalService			

**6.6.7.19 TerminalService**

This abstract object holds attributes used to configure the console terminal and virtual terminal instances.

**Table 6-246 - TerminalService Object Attributes**

Attribute Name	Type	Required Attribute	Type Constraints	Units	Default Value
ScreenLength	Integer	No		Lines	24
ScreenWidth	Integer	No		Columns	80

**Table 6-247 - TerminalService Object Associations**

Associated Object Name	Type	Near-end Multiplicity	Far-end Multiplicity	Label
InputTransportControls	Directed composition to InputTransportControls			

**6.6.7.19.1 TerminalService Object Attributes****6.6.7.19.1.1 ScreenLength**

This attribute configures the number of lines on the screen of the terminal instance.

**6.6.7.19.1.2 ScreenWidth**

This attribute configures the number of columns on the screen of the terminal instance.

### 6.6.7.20 *InputTransportControls*

This object configures SSH and Telnet settings for a virtual terminal instance.

**Table 6-248 - *InputTransportControls* Object Attributes**

Attribute Name	Type	Required Attribute	Type Constraints	Units	Default Value
TelnetEnabled	Boolean	No			false
SshEnabled	Boolean	No			false

#### 6.6.7.20.1 *InputTransportControls* Object Attributes

##### 6.6.7.20.1.1 TelnetEnabled

This attribute configures whether Telnet is enabled on the virtual terminal interface.

##### 6.6.7.20.1.2 SshEnabled

This attribute configures whether SSH is enabled on the virtual terminal interface.

### 6.6.7.21 *FailOver*

This object configures the automatic fail-over operation of the CCAP.

**Table 6-249 - *FailOver* Object Attributes**

Attribute Name	Type	Required Attribute	Type Constraints	Units	Default Value
AutoFailBack	Boolean	No			true

#### 6.6.7.21.1 *FailOver* Object Attributes

##### 6.6.7.21.1.1 AutoFailBack

This attribute configures whether or not the CCAP automatically switches back to a line card after a failover event. If true, when the failed card is operational, the CCAP will begin using that card again. If False, the operator will have to perform the failback operation.

### 6.6.7.22 *LocalTime*

The LocalTime object allows the configuration of a Primary and Secondary NTP server, as well as other local time attributes. This object does not fully configure all NTP client parameters. Vendors may provide additional configuration objects to fully configure the NTP and SNTP protocols if desired.

**Table 6-250 - *LocalTime* Object Attributes**

Attribute Name	Type	Required Attribute	Type Constraints	Units	Default Value
NtpMaster	Host	Yes			
NtpBackup	Host	No			
TimeZone	String	No			00
DaylightSavingTimeShiftDates	String	No			3.2.0/02.00, 11.1.0/02.00, 01
DstRecurringChange	Boolean	No			false

**Table 6-251 - LocalTime Object Associations**

Associated Object Name	Type	Near-end Multiplicity	Far-end Multiplicity	Label
IpInterface	Association with an IpInterface			SourceIpInterfaceName

This association specifies the IP interface to use as the source interface. If an IP interface is not specified, the behavior of the CCAP is vendor-specific.

#### 6.6.7.22.1 LocalTime Object Attributes

##### 6.6.7.22.1.1 NtpMaster

This attribute configures the IP address or FQDN of the Master NTP server.

##### 6.6.7.22.1.2 NtpBackup

This attribute configures the IP address or FQDN of the backup NTP Server in case the master NTP fails.

##### 6.6.7.22.1.3 TimeZone

This attribute represents the offset value to the local time to arrive at UTC Time. The value has the following format:

hh[:mm] - the hour

(0 <= hh <= 24) - required, minutes

(0 <= mm <= 59) -the mm (minutes) is optional. The hour can be preceded by a minus sign (-).

##### 6.6.7.22.1.4 DaylightSavingTimeShiftDates

This attribute indicates when to change to and from daylight saving (or summer) time. The value has the form: date1/time1,date2/time2,offset. The first date describes when the change from standard to daylight saving time occurs, and the second date describes when the change back happens.

Each time field describes when, in current local time, the change to the other time is made. The format of date is the following: m.w.d - The dth day (0 <= d <= 6) of week w of month m of the year (1 <= w <= 5, 1 <= m <= 12, where week 5 means "the last d day in month m", which may occur in the fourth or fifth week). Week 1 is the first week in which the dth day occurs. Day zero is Sunday.

The time format is the following: hh:mm - The offset value is the value that needs to be added to the local time to arrive at UTC Time during the daylight saving time. The offset value has the following format: hh[:mm].

The default value is the second Sunday in March (start) and the first Sunday in November (end).

##### 6.6.7.22.1.5 DstRecurringChange

This attribute controls whether the CCAP automatically adjusts the time to Daylight Saving Time (DST). If enabled, the CCAP will adjust the time based on the value of the DaylightSavingTimeCalendar attribute.

#### 6.6.7.23 IpInterface

This configuration object is included in Figure 6-18 for reference. It is defined in Section 6.6.8.5, IpInterface.

### 6.6.8 Interface Configuration Objects

Interfaces in the CCAP are different than ports, in that they are intended to be Layer 3 entities. The following object model shows the relationships for interfaces in the CCAP.

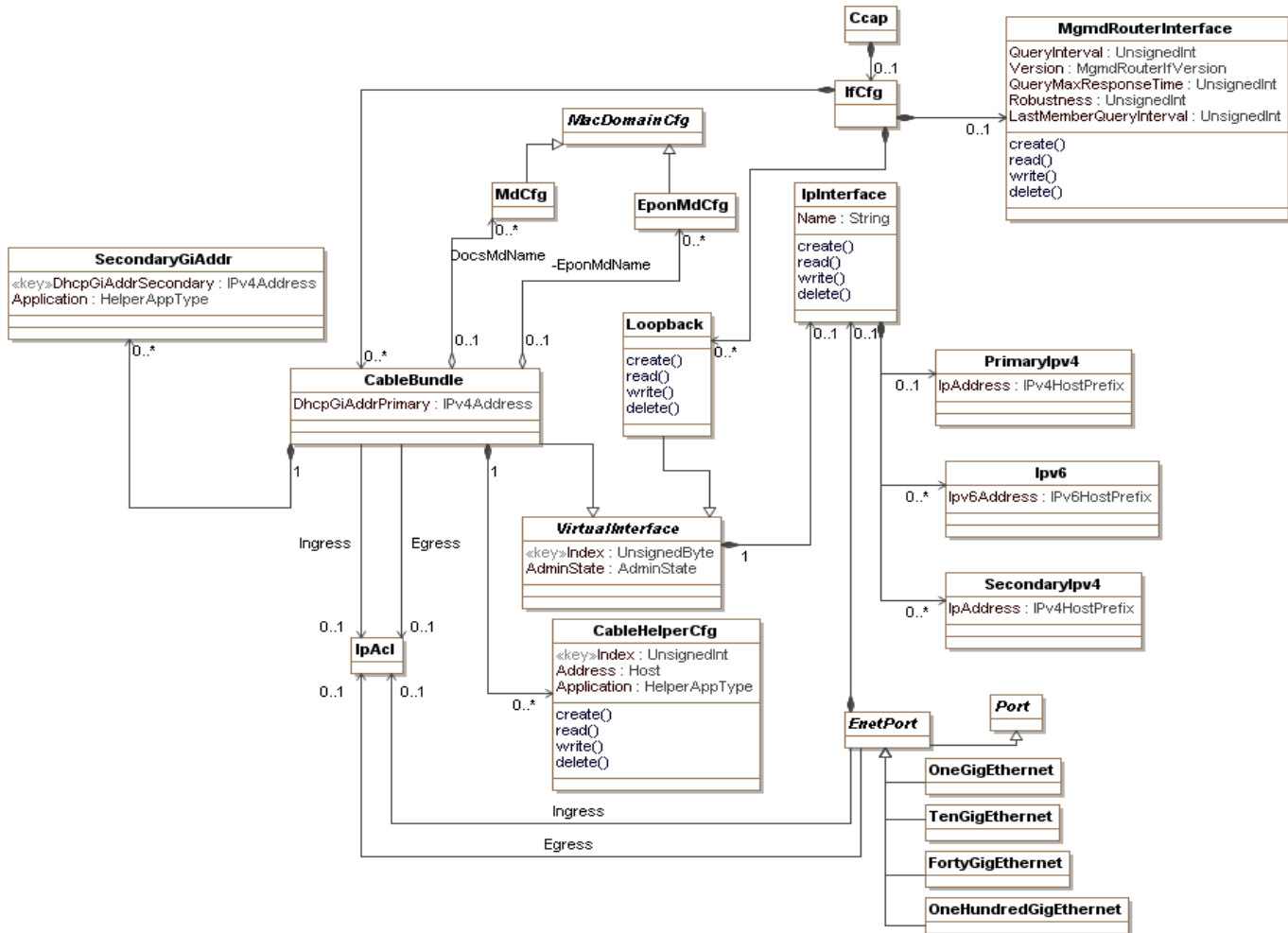

Figure 6-19 - Interface Configuration Objects

#### 6.6.8.1 Ccap

This configuration object is included in Figure 6-19 for reference. It is defined in Section 6.6.3.1, Ccap Object.

#### 6.6.8.2 IfCfg

The IfCfg object is the primary container of interface configuration objects.

Table 6-252 - IfCfg Object Associations

Associated Object Name	Type	Near-end Multiplicity	Far-end Multiplicity	Label
CableBundle	Directed composition to CableBundle		0..*	
Loopback	Directed composition to Loopback		0..*	

Associated Object Name	Type	Near-end Multiplicity	Far-end Multiplicity	Label
MgmdRouterInterface	Directed composition to MgmdRouterInterface		0..1	

### 6.6.8.3 Loopback

A loopback interface is a logical interface that is not tied to a specific hardware port. The CCAP MUST support a loopback interface to provide a virtual interface to assist in overall system configuration.

**Table 6-253 - Loopback Object Associations**

Associated Object Name	Type	Near-end Multiplicity	Far-end Multiplicity	Label
VirtualInterface	Specialization of VirtualInterface			

### 6.6.8.4 VirtualInterface

The VirtualInterface abstract object contains attributes shared by CCAP virtual interfaces (Loopback and CableBundle).

**Table 6-254 - VirtualInterfaceObject Attributes**

Attribute Name	Type	Required Attribute	Type Constraints	Units	Default Value
Index	UnsignedByte	Yes (Key)			
AdminState	AdminState	No			down

**Table 6-255 - VirtualInterface Object Associations**

Associated Object Name	Type	Near-end Multiplicity	Far-end Multiplicity	Label
IpInterface	Directed composition to IpInterface	1	0..1	

#### 6.6.8.4.1 VirtualInterface Object Attributes

##### 6.6.8.4.1.1 Index

The index for the VirtualInterface instance.

##### 6.6.8.4.1.2 AdminState

This attribute configures the administrative state of the virtual interface.

### 6.6.8.5 IpInterface

IpInterface is an object used to configure an IP interface on the CCAP. Attributes from this object are used by the CableBundle, Loopback, and EnetPort objects. For a CCAP operating in non-routing mode, an IpInterface instance need not be configured for CableBundle objects.

**Table 6-256 - IpInterface Object Attributes**

Attribute Name	Type	Required Attribute	Type Constraints	Units	Default Value
Name	String	Yes (Key)			

IpInterface has several associations.

**Table 6-257 - IpInterface Object Associations**

Associated Object Name	Type	Near-end Multiplicity	Far-end Multiplicity	Label
PrimaryIpv4	Directed composition to PrimaryIpv4		0..1	
Ipv6	Directed composition to Ipv6		0..*	
SecondaryIpv4	Directed composition to SecondaryIpv4		0..*	

**6.6.8.5.1 IpInterface Object Attributes**

**6.6.8.5.1.1 Name**

The name for this instance of an interface. This name is used to reference a specific IpInterface instance and associate it with the referring object.

**6.6.8.6 PrimaryIpv4**

The PrimaryIpv4 object allows a primary IPv4 interface address to be configured.

**Table 6-258 - PrimaryIpv4 Object Attributes**

Attribute Name	Type	Required Attribute	Type Constraints	Units	Default Value
IpAddress	Ipv4HostPrefix	Yes			

**6.6.8.6.1 PrimaryIpv4 Object Attributes**

**6.6.8.6.1.1 IpAddress**

This attribute configures the IPv4 address and prefix for this instance.

**6.6.8.7 Ipv6**

The PrimaryIpv6 object allows a primary IPv6 interface address to be configured. For IPv6 addresses, the concept of primary and secondary does not apply; for this reason, a list of IPv6 addresses may be configured.

**Table 6-259 - Ipv6 Object Attributes**

Attribute Name	Type	Required Attribute	Type Constraints	Units	Default Value
Ipv6Address	Ipv6HostPrefix	Yes			

**6.6.8.7.1 Ipv6 Object Attributes**

**6.6.8.7.1.1 Ipv6Address**

This attribute configures the IPv6 address and prefix for this instance.

**6.6.8.8 SecondaryIpv4**

The SecondaryIpv4 object allows secondary IPv4 addresses to be configured.



**Table 6-260 - SecondaryIpv4 Object Attributes**

Attribute Name	Type	Required Attribute	Type Constraints	Units	Default Value
IpAddress	Ipv4HostPrefix	Yes			

#### 6.6.8.8.1 SecondaryIpv4 Object Attributes

##### 6.6.8.8.1.1 IpAddress

This attribute configures the IPv4 address and prefix for this instance.

#### 6.6.8.9 CableBundle

A CableBundle is a compact way of assigning Layer 3 network addresses to a set of Layer 2 interfaces. This allows the bundled Layer 2 interfaces to share a common pool of IPv4 Subnets or IPv6 prefixes so that these IP address resources can be efficiently used by the CCAP operating in routing mode.

**Table 6-261 - CableBundle Object Attributes**

Attribute Name	Type	Required Attribute	Type Constraints	Units	Default Value
DhcpGiAddrPrimary	Ipv4Address	Yes			

A CableBundle can only be associated with MAC domains of a given type; the CCAP MUST reject the configuration of a CableBundle instance in which both an MdCfg and an EponMdCfg have been configured.

**Table 6-262 - CableBundle Object Associations**

Associated Object Name	Type	Near-end Multiplicity	Far-end Multiplicity	Label
MdCfg	Directed aggregation to MdCfg	0..1	0..*	DocsMdName
EponMdCfg	Directed aggregation to EponMdCfg	0..1	0..*	EponMdName
CableHelperCfg	Directed composition to CableHelperCfg	1	0..*	
SecondaryGiAddr	Directed composition to SecondaryGiAddr	1	0..*	
IpAcl	Directed association to IpAcl		0..1	Ingress
IpAcl	Directed association to IpAcl		0..1	Egress

#### 6.6.8.9.1 CableBundle Object Attributes

##### 6.6.8.9.1.1 DhcpGiAddrPrimary

This attribute configures how the DHCP relay agent populates the GiAddr for relayed DHCP traffic on the CCAP in routing mode.

#### 6.6.8.10 CableHelperCfg

The CableHelperCfg configuration object allows the operator to configure different Cable Helper addresses for DHCP Clients. The CCAP operating in routing mode ties these Cable Helper addresses to the CableBundle interfaces and the MAC Domains they service.

**Table 6-263 - CableHelperCfg Object Attributes**

Attribute Name	Type	Required Attribute	Type Constraints	Units	Default Value
Index	UnsignedInt	Yes (Key)			

Attribute Name	Type	Required Attribute	Type Constraints	Units	Default Value
Address	Host	Yes			
Application	Enum	No	other(1) host(2) mta(3) stb(4) cm(5) all(6)		all

**6.6.8.10.1 CableHelperCfg Object Attributes**

**6.6.8.10.1.1 Index**

The index for the CableHelperCfg instance.

**6.6.8.10.1.2 Address**

This attribute configures the IP address or FQDN of the DHCP server configured as a cable helper.

**6.6.8.10.1.3 Application**

This attribute configures the device class for which this cable helper configuration applies. The value of other(1) is used when a vendor-extension has been implemented for this attribute.

**6.6.8.11 SecondaryGiAddr**

This object allows a secondary GiAddr to be configured for a CableBundle instance.

**Table 6-264 - SecondaryGiAddr Object Attributes**

Attribute Name	Type	Required Attribute	Type Constraints	Units	Default Value
DhcpGiAddrSecondary	Ipv4Address	Yes (Key)			
Application	Enum	No	other(1) host(2) mta(3) stb(4) cm(5) all(6)		all

**6.6.8.11.1 SecondaryGiAddr Object Attributes**

**6.6.8.11.1.1 DhcpGiAddrSecondary**

This attribute configures how the DHCP relay agent populates the secondary GiAddr for relayed DHCP traffic on the CCAP in routing mode.

**6.6.8.11.1.2 Application**

This attribute configures the device class for which this GiAddr instance applies. The value of other(1) is used when a vendor-extension has been implemented for this attribute.

**6.6.8.12 MacDomainCfg**

This configuration object is included in Figure 6-19 for reference. It is defined in Section 6.6.6.6.6, MacDomainCfg.

**6.6.8.13 EponMdCfg**

This configuration object is included in Figure 6-19 for reference. It is defined in Section 6.6.10.6, EponMdCfg.

**6.6.8.14 MdCfg**

This configuration object is included in Figure 6-19 for reference. It is defined in Section 6.6.6.4, MdCfg.

**6.6.8.15 EnetPort**

This configuration object is included in Figure 6-19 for reference. It is defined in Section 6.6.4.15, EnetPort.

**6.6.8.16 OneGigEthernet**

This configuration object is included in Figure 6-19 for reference. It is defined in Section 6.6.4.16, OneGigEthernet.

**6.6.8.17 TenGigEthernet**

This configuration object is included in Figure 6-19 for reference. It is defined in Section 6.6.4.17, TenGigEthernet.

**6.6.8.18 FortyGigEthernet**

This configuration object is included in Figure 6-19 for reference. It is defined in Section 6.6.4.18, FortyGigEthernet.

**6.6.8.19 OneHundredGigEthernet**

This configuration object is included in Figure 6-19 for reference. It is defined in Section 6.6.4.19, OneHundredGigEthernet.

**6.6.8.20 Port**

This configuration object is included in Figure 6-19 for reference. It is defined in Section 6.6.4.10, Port.

**6.6.8.21 MgmRouterInterface**

This configuration object allows for configuration of the CCAP IP Multicast Router. These configuration objects are defined in the Multicast Group Membership Discovery MIB, [RFC 5519]. The table shown here is derived from this MIB.

**Table 6-265 - MgmRouterInterface Object Attributes**

Attribute Name	Type	Required Attribute	Type Constraints	Units	Default Value
QueryInterval	UnsignedInt	No		seconds	125
Version	Enum	No	other(1), igmpv1(2), igmpv2OrMldv1(3), igmpv3OrMldv2(4)		igmpv2OrMldv1
QueryMaxResponseTime	UnsignedInt	No	0..31744	tenths of seconds	100
Robustness	UnsignedInt	No	1..225		2
LastMemberQueryInterval	UnsignedInt	No	0..31744	tenths of seconds	10

### 6.6.8.21.1 *MgmdRouterInterface Object Attributes*

#### 6.6.8.21.1.1 QueryInterval

The frequency in seconds at which IGMP or MLD Host-Query packets are transmitted on this interface.

#### 6.6.8.21.1.2 Version

The version of MGMD that is running on this interface. Value 2 applies to IGMPv1 routers only. Value 3 applies to IGMPv2 and MLDv1 routers, and value 4 applies to IGMPv3 and MLDv2 routers.

This object can be used to configure a router capable of running either version. For IGMP and MLD to function correctly, all routers on a LAN need to be configured to run the same version on that LAN.

#### 6.6.8.21.1.3 QueryMaxResponseTime

The maximum query response interval in seconds advertised in MGMDv2 or IGMPv3 queries on this interface.

#### 6.6.8.21.1.4 Robustness

The robustness variable utilized by an MGMDv3 host in sending state-change reports for multicast routers. To ensure the state-change report is not missed, the host retransmits the state-change report [mgmdHostInterfaceVersion3Robustness - 1] times. The variable needs to be a non-zero value.

#### 6.6.8.21.1.5 LastMemberQueryInterval

The Last Member Query Interval is the Max Query Response Interval in tenths of a second inserted into group-specific queries sent in response to leave group messages, and is also the amount of time between group-specific query messages. This value may be tuned to modify the leave latency of the network. A reduced value results in reduced time to detect the loss of the last member of a group. The value of this object is irrelevant if mgmdRouterInterfaceVersion is 1.

### 6.6.9 Management Configuration Objects

The management configuration objects configure fault management and SNMP for the CCAP.

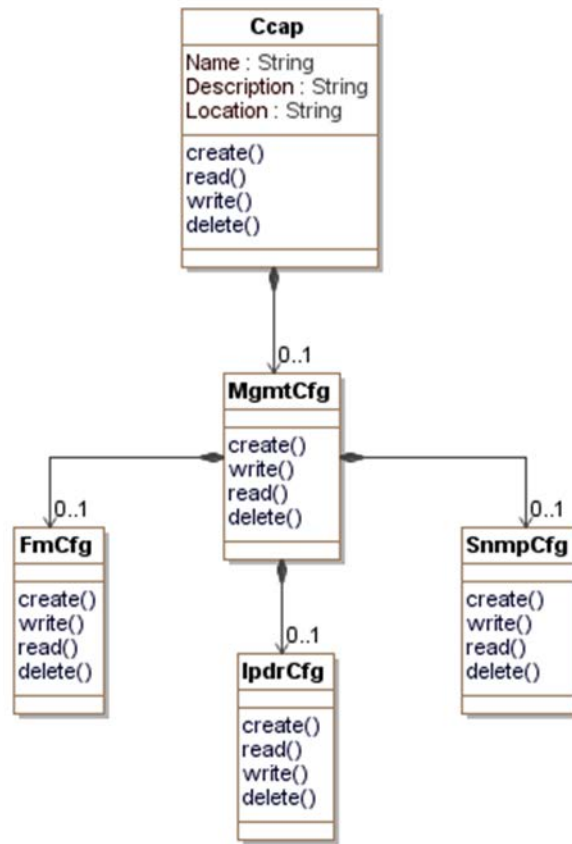

Figure 6-20 - Management Configuration Objects

#### 6.6.9.1 Ccap

This configuration object is included in Figure 6-20 for reference. It is defined in Section 6.6.3.1, Ccap Object.

#### 6.6.9.2 MgmtCfg

The MgmtCfg object is the primary container of the management configuration objects. It has the following associations:

Table 6-266 - MgmtCfg Object Associations

Associated Object Name	Type	Near-end Multiplicity	Far-end Multiplicity	Label
FmCfg	Directed composition to FmCfg		0..1	
SnmpCfg	Directed composition to SnmpCfg		0..1	
IpdrCfg	Directed composition to IpdrCfg		0..1	

### 6.6.9.3 FmCfg

This configuration object is included in Figure 6-20 for reference. It is defined in Section 6.6.9.6.2, FmCfg.

### 6.6.9.4 SnmpCfg

This configuration object is included in Figure 6-20 for reference. It is defined in Section 6.6.9.7.2, SnmpCfg.

### 6.6.9.5 IpdrCfg

This configuration object is included in Figure 6-20 for reference. It is defined in Section 6.6.9.8.2, IpdrCfg.

### 6.6.9.6 Fault Management Configuration Objects

The CCAP will employ much of the event reporting methods that have long been a part of DOCSIS and PMI. This section will detail the configuration portions of the event reporting infrastructure which have been adapted from [OSSv3.0]. The Object model for these configured objects is shown below.

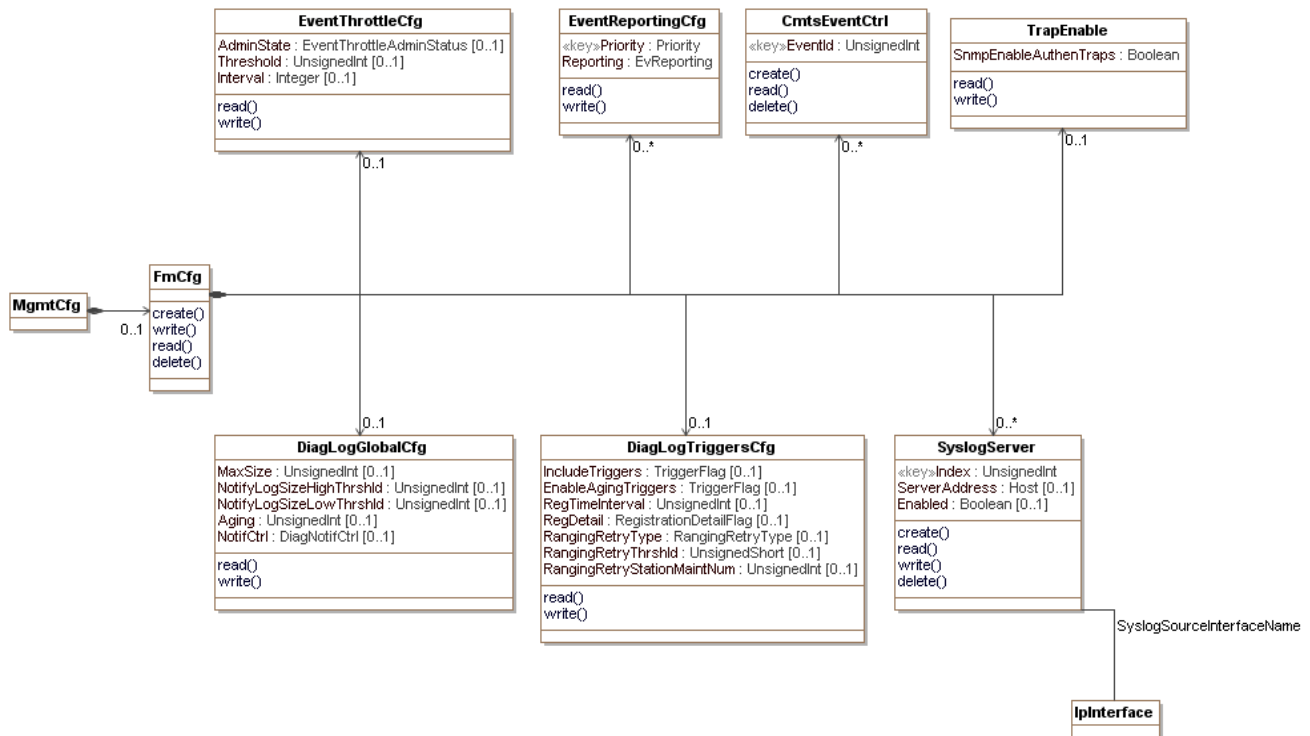

Figure 6-21 - Fault Management Configuration Objects

These objects allow the operator to configure logging for various events so these issues can be tracked.

#### 6.6.9.6.1 MgmtCfg

This configuration object is included in Figure 6-20 for reference. It is defined in Section 6.6.9.2, MgmtCfg.

#### 6.6.9.6.2 FmCfg

The FmCfg object is the primary container of fault management configuration objects.

The Diagnostic Log is one of the DOCSIS Fault Management functions. The Diagnostic Log allows operators to diagnose and troubleshoot potential problems with Cable Modems (CMs), CMTS cable interfaces, or the cable plant by detecting and tracking CMs that have intermittent connectivity problems or unstable operations including:

- CM repeated registration
- Station Maintenance retry

Only detected CMs are reported in the Diagnostic Log for further analysis. Diagnostic Log entries are aged out based on the configuration of the specific aging attributes. The FmCfg contains the configuration objects for the Diagnostic Log function.

The FmCfg has the following associations:

**Table 6-267 - FmCfg Object Associations**

Associated Object Name	Type	Near-end Multiplicity	Far-end Multiplicity	Label
EventThrottleCfg	Directed composition to EventThrottleCfg		0..1	
EventReportingCfg	Directed composition to EventReportingCfg		0..*	
CmtsEventCtrl	Directed composition to CmtsEventCtrl		0..*	
TrapEnable	Directed composition to TrapEnable		0..1	
DiagLogGlobalCfg	Directed composition to DiagLogGlobalCfg		0..1	
DiagLogTriggersCfg	Directed composition to DiagLogTriggersCfg		0..1	
SyslogServer	Directed composition to SyslogServer		0..*	

#### 6.6.9.6.3 *EventThrottleCfg*

This configuration object is based on the docsDevEvent group defined in [RFC 4639] and uses the following attributes without modification for CCAP:

- AdminStatus (renamed AdminState)
- Threshold
- Interval

Reference: [RFC 4639], docsDevEvent Group

#### 6.6.9.6.4 *EventReportingCfg*

This configuration object is based on the docsDevEvControlTable object defined in [RFC 4639] and will be used without modification for CCAP.

Reference: [RFC 4639], docsDevEvControlTable

#### 6.6.9.6.5 *CmtsEventCtrl*

This object represents the control mechanism to enable the dispatching of events based on the Event Id. The following rules define the event control behavior:

- If the CmtsEventCtrl object has no instances or contains an instance with Event ID 0, then all events matching the Local Log settings of docsDevEvReporting are sent to local log ONLY.
- Additionally, if the CmtsEventCtrl object contains configured instances, then Events matching the Event Ids configured in the object are sent according to the settings of the docsDevEvReporting object; i.e., Traps, Syslog, etc.

The CMTS and CCAP MUST persist all instances of CmtsEventCtrl across reinitializations.

**Table 6-268 - CmtsEventCtrl Object**

Attribute Name	Type	Required Attribute	Type Constraints	Units	Default
EventId	unsignedInt	key			

6.6.9.6.5.1 CmtsEvent Ctrl Object Attributes

**6.6.9.6.5.1.1 EventId**

This key represents the Event ID of the event being enabled for delivery to a dispatch mechanism (e.g., syslog).

References: Annex D.

6.6.9.6.6 TrapEnable

This configuration object contains attributes which allow enabling or disabling of SNMP Notifications. The SnmpEnableAuthenTraps attribute is taken from [RFC 3418] and will be used without modification for the CCAP.

Reference: [RFC 3418], snmpEnableAuthenTraps

6.6.9.6.7 DiagLogGlobalCfg

The following read-only attributes have been removed:

- CurrentSize
- LastResetTime
- LastClearTime

This object defines the parameters to manage and control the instantiation of CMs in the Diagnostic Log object.

The CMTS and CCAP MUST persist the values of the attributes of the DiagLogGlobalCfg object across reinitializations.

**Table 6-269 - DiagLogGlobalCfg Object Attributes**

Attribute Name	Type	Required Attribute	Type Constraints	Units	Default
MaxSize	unsignedInt	No	1..4294967295	instances	100
NotifyLogSizeHighThrshld	unsignedInt	No	1..4294967295	instances	80
NotifyLogSizeLowThrshld	unsignedInt	No	1..4294967295	instances	60
Aging	unsignedInt	No	15..86400	minutes	10080
NotifCtrl	EnumBits	No	highThresholdReached(0) lowThresholdReached(1) full(2)		"H"

6.6.9.6.7.1 DiagLogGlobalCfg Object Attributes

**6.6.9.6.7.1.1 MaxSize**

This attribute indicates the maximum number of CM instances that can be reported in the Log.

**6.6.9.6.7.1.2 NotifyLogSizeHighThrshld**

This attribute is the Log high threshold value. When the number of instances in the Log exceeds this value, the CMTS will trigger a HighThreshold event.



### 6.6.9.6.7.1.3 NotifyLogSizeLowThrshld

This attribute is the Log low threshold value. When the number of instances in Log drops to this value, the CMTS will trigger a LowThreshold event, but only if the Log number of instances previously exceeded the NotifyLogSizeHighThrshld value.

### 6.6.9.6.7.1.4 Aging

This attribute defines a period of time after which an instance in the Log and its corresponding LogDetail instance (if present) are removed unless the Log instance is updated by an enabled trigger detection process.

### 6.6.9.6.7.1.5 NotifCtrl

This attribute is used to enable diagnostic log related notifications. Setting bit 0 enables notification for reaching log size high threshold. Setting bit 1 enables notification for returning back to log size low threshold after reaching log size high threshold. Setting bit 2 enables notification for Diagnostic Log size full.

### 6.6.9.6.8 DiagLogTriggersCfg

This object defines the parameters to configure the Diagnostic Log triggers. One or more triggers can be configured to define the actions of creating or updating CM entries into the Diagnostic Log.

The CMTS and CCAP MUST persist the values of the attributes of the DiagLogTriggersCfg object across reinitializations.

**Table 6-270 - DiagLogTriggersCfg Object Attributes**

Attribute Name	Type	Required Attribute	Type Constraints	Units	Default
IncludeTriggers	TriggerFlag	No			'C0'H
EnableAgingTriggers	TriggerFlag	No			"H
RegTimeInterval	unsignedInt	No	60..86400	seconds	90
RegDetail	EnumBits	No	initialRanging(1) rangingAutoAdjComplete(2) startEae(3) startDhcpv4(4) startDhcpv6(5) dhcpv4Complete(6) dhcpv6Complete(7) startConfigFileDownload(8) configFileDownloadComplete(9) startRegistration(10) registrationComplete(11) bpilnit(12) operational(13)		"H
RangingRetryType	Enum	No	consecutiveMiss(1) missRatio(2)		1
RangingRetryThrshld	unsignedByte	No	3..12		6
RangingRetryStationMaintNum	unsignedShort	No	60..65535		90

### 6.6.9.6.8.1 DiagLogTriggersCfg Object Attributes

#### 6.6.9.6.8.1.1 IncludeTriggers

This attribute turns individual diagnostic triggers on and off at a given time when each trigger is set to '1' or '0', respectively.

**6.6.9.6.8.1.2 EnableAgingTriggers**

This attribute enables and disables the aging of individual triggers at a given time when each trigger is set to '1' or '0' respectively. If a log entry is added by multiple triggers, and aging is disabled for one of those triggers, the CMTS MUST NOT age out such entry.

**6.6.9.6.8.1.3 RegTimeInterval**

This attribute is an operator empirically derived, worst-case number of seconds which the CM requires to complete registration. If the CM has not completed the registration stage within this registration time interval, the CM will be added to the Diagnostic Log.

**6.6.9.6.8.1.4 RegDetail**

This attribute provides for setting a bit representing a CM registration state to enable counting the number of times the CMTS determines that such CM reaches that state as the last state before failing to proceed further in the registration process and within the time interval considered for the CM registration trigger detection.

The meaning of the bit positions (left to right) are as follows:

- initialRanging(1)
- rangingAutoAdjComplete(2)
- startEae(3)
- startDhcpv4(4)
- startDhcpv6(5)
- dhcpv4Complete(6)
- dhcpv6Complete(7)
- startConfigFileDownload(8)
- configFileDownloadComplete(9)
- startRegistration(10)
- registrationComplete(11)
- bpiInit(12)
- operational(13)

**6.6.9.6.8.1.5 RangingRetryType**

This attribute selects the type of ranging retry trigger to be enable in the Diagnostic Log. A CM failure to perform ranging when a ranging opportunity is scheduled by the CMTS is counted as ranging miss. The ranging retry trigger can be configured to either look at consecutive ranging misses or ranging miss ratio over total number of station maintenance opportunities for a certain time period. Setting this object to 'consecutiveMiss' will select consecutive ranging misses as ranging retry trigger criteria. Setting this object to 'missRatio' will select ranging miss ratio as ranging retry criteria.

**6.6.9.6.8.1.6 RangingRetryThreshld**

This attribute indicates the maximum number of consecutive intervals in which the CMTS does not detect a CM acknowledgement of a MAC-layer station maintenance message before the CM is added to the Diagnostic Log. The value of RangingRetryType decides if consecutive ranging miss or ranging miss ratio is used as trigger.

**6.6.9.6.8.1.7 RangingRetryStationMaintNum**

This attribute indicates the number of station maintenance opportunities to monitor for the ranging retry trigger. This value implies time intervals in a certain range. DOCSIS specifies that the CMTS schedules ranging opportunities to

CMs be sufficiently smaller than T4. There is no fixed formula to derive at a fixed time interval, that is, how many ranging opportunities may be offered to a CM by the CMTS; hence, using the number of station maintenance opportunities provides a ratio with the fixed denominators, while also taking the time factor into consideration.

#### 6.6.9.6.9 SyslogServer

This object allows the configuration of a specific Syslog Server.

**Table 6-271 - SyslogServer Object Attributes**

Attribute Name	Type	Required Attribute	Type Constraints	Units	Default Value
Index	UnsignedInt	Yes (Key)			
ServerAddress	Host	Yes			
Enabled	Boolean	No			false

**Table 6-272 - SyslogServer Object Associations**

Associated Object Name	Type	Near-end Multiplicity	Far-end Multiplicity	Label
IpInterface	Association with an IpInterface			SyslogSourceInterfaceName

#### 6.6.9.6.9.1 SyslogServer Object Attributes

##### 6.6.9.6.9.1.1 Index

This key represents the unique identifier of an instance in this object.

##### 6.6.9.6.9.1.2 ServerAddress

This attribute represents the IP address of the Syslog server. If DNS is supported, this attribute can contain the FQDN of the Syslog server.

##### 6.6.9.6.9.1.3 Enabled

Indicates if the Syslog server is used for sending Syslog messages or is disabled.

### 6.6.9.7 SNMP Agent Configuration Objects

The configuration objects for the CCAP SNMP Agent are shown below. This is only a policy configuration, but can be matched to full SNMPv3 implementations using similar procedures as done for TLV 38, 53, and 54 described in [OSSv3.0].

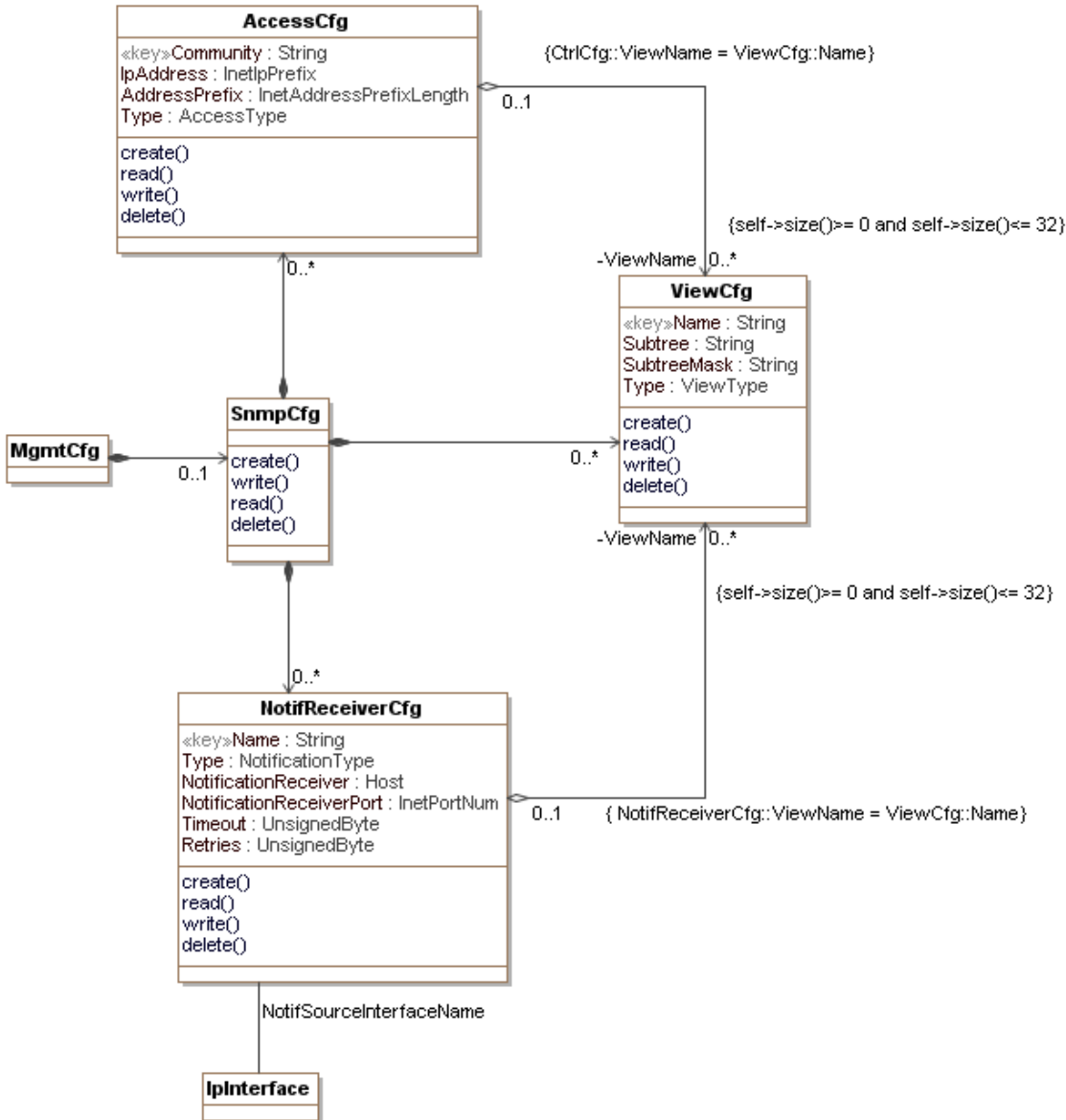

Figure 6-22 - SNMP Agent Configuration Objects

#### 6.6.9.7.1 MgmtCfg

This configuration object is included in Figure 6-20 for reference. It is defined in Section 6.6.9.2, MgmtCfg.

#### 6.6.9.7.2 SmpCfg

The SmpCfg object is the primary container of SNMP configuration objects. It has the following associations:

**Table 6-273 - SnmpCfg Object Associations**

Associated Object Name	Type	Near-end Multiplicity	Far-end Multiplicity	Label
AccessCfg	Directed composition to AccessCfg		0..*	
ViewCfg	Directed composition to ViewCfg		0..*	
NotifReceiverCfg	Directed composition to NotifReceiverCfg		0..*	

### 6.6.9.7.3 AccessCfg

This object defines the configuration of access control for SNMPv1/v2c received request messages. When an SNMP request message is received, the system checks the validity of the request by matching the community string, source (IP address, subnet), access type and view restrictions for included SNMP OIDs in the request.

**Table 6-274 - AccessCfg Object Attributes**

Attribute Name	Type	Required Attribute	Type Constraints	Units	Default Value
Community	String	Yes (Key)	1..32		
IpAddress	InetIpPrefix	Yes			
AddressPrefix	InetAddressPrefixLength	Yes			
Type	Enum	No	readOnly(1), readWrite(2)		readOnly

**Table 6-275 - AccessCfg Object Associations**

Associated Object Name	Type	Near-end Multiplicity	Far-end Multiplicity	Label
ViewCfg	Directed aggregation to ViewCfg	0..1	0..*	ViewName

#### 6.6.9.7.3.1 AccessCfg Object Attributes

##### 6.6.9.7.3.1.1 Community

The community string defined for the access control rule.

##### 6.6.9.7.3.1.2 IpAddress

The address used in conjunction with the AddressPrefix attribute used to validate the source of an incoming SNMP request.

##### 6.6.9.7.3.1.3 AddressPrefix

The prefix to apply to the IpAddress attribute for matching valid sources for the SNMP requests.

##### 6.6.9.7.3.1.4 Type

Defines the type of access granted to the SNMP request. An enumeration of "other" was purposefully excluded from this enumeration.

### 6.6.9.7.4 ViewCfg

This object defines a View consisting of a single OID subtree matching rule for inclusion or exclusion as part of a SNMP message processing procedure such as access authorization or dispatch or notifications.

**Table 6-276 - ViewCfg Object Attributes**

Attribute Name	Type	Required Attribute	Type Constraints	Units	Default Value
Name	String	Yes (Key)			
Subtree	String	Yes			
SubtreeMask	String	Yes			
Type	Enum	Yes	other(1), included(2), excluded(3)		

6.6.9.7.4.1 ViewCfg Object Attributes

**6.6.9.7.4.1.1 Name**

The administrative name of an instance of this object.

**6.6.9.7.4.1.2 Subtree**

The OID subtree to be matched for the access view. This attribute is formatted as the text representation of an ASN.1 OID following the ABNF notation below:

Subtree = empty | OID [.OID]\*

OID = number; 0..128

The matching procedures are borrowed from [RFC 3414] for tree views matching with the difference that the configuration elements uses a text notation to represent OIDs and OID masks. See the SubtreeMask attribute definition for further information.

**6.6.9.7.4.1.3 SubtreeMask**

A mask to match OIDs for inclusion or exclusion as part of the view. This attribute definition is borrowed from [RFC 3414]. The only difference is that instead of bits per OID, a byte of value 0 or 1 is used to represent this attribute.

Each byte value 1 indicates the inclusion of the corresponding OID position in the Subtree attribute, while the value 0 indicates no need to match. See [RFC 3414] for details.

**6.6.9.7.4.1.4 Type**

Indicates inclusion or exclusion of the subtree for the defined view.

6.6.9.7.5 NotifReceiverCfg

This object defines where to send notifications. When an event is to be dispatched as a notification, the system checks for instances of this object that have the notification OID associated with the event as part of their Inclusion list in their ViewCfg instances. The system then sends notifications based on the matched occurrences per their configured parameters.

If an instance of NotifSourceInterfaceName is not configured, then selection of notification source interface is vendor proprietary.

**Table 6-277 - NotifReceiverCfg Object Attributes**

Attribute Name	Type	Required Attribute	Type Constraints	Units	Default Value
Name	String	Yes (Key)	1..32		
Type	Enum	No	snmpV1Trap(1), snmpV2cTrap(2), snmpV2Inform(3)		snmpV2cTrap

Attribute Name	Type	Required Attribute	Type Constraints	Units	Default Value
NotificationReceiver	Host	Yes			
NotificationReceiverPort	InetPortNum	No			162
Timeout	UnsignedByte	No		seconds	1
Retries	UnsignedByte	No			3

**Table 6-278 - NotifReceiverCfg Object Associations**

Associated Object Name	Type	Near-end Multiplicity	Far-end Multiplicity	Label
ViewCfg	Directed aggregation to ViewCfg	0..1	0..*	ViewName
IpInterface	Association with IpInterface			NotifSourceInterfaceName

### 6.6.9.7.5.1 NotifReceiverCfg Object Attributes

#### 6.6.9.7.5.1.1 Name

The administrative name of an instance in this object.

#### 6.6.9.7.5.1.2 Type

Indicates the type of SNMP notification being sent:

- snmpV1Trap: SNMP v1 trap
- snmpV2cTrap: SNMP v2c trap
- snmpV2cInform: SNMP v2c Inform

An enumeration of "other" was purposefully excluded from this enumeration.

#### 6.6.9.7.5.1.3 NotificationReceiver

The IP address or FQDN of the notification receiver.

#### 6.6.9.7.5.1.4 Port

The UDP port the notification receiver listen for messages.

#### 6.6.9.7.5.1.5 Timeout

The time in seconds the sender waits for receiving confirmation for a notification being sent. This attribute is meaningful only when the attribute Type is set to snmpV2cInform(4); otherwise it is ignored.

#### 6.6.9.7.5.1.6 Retries

The number of retries the sender will attempt in case of it has not received confirmation of inform reception. This attribute is meaningful only when the attribute Type is set to snmpV2cInform(4); otherwise it is ignored.

### 6.6.9.8 IPDR Configuration Objects

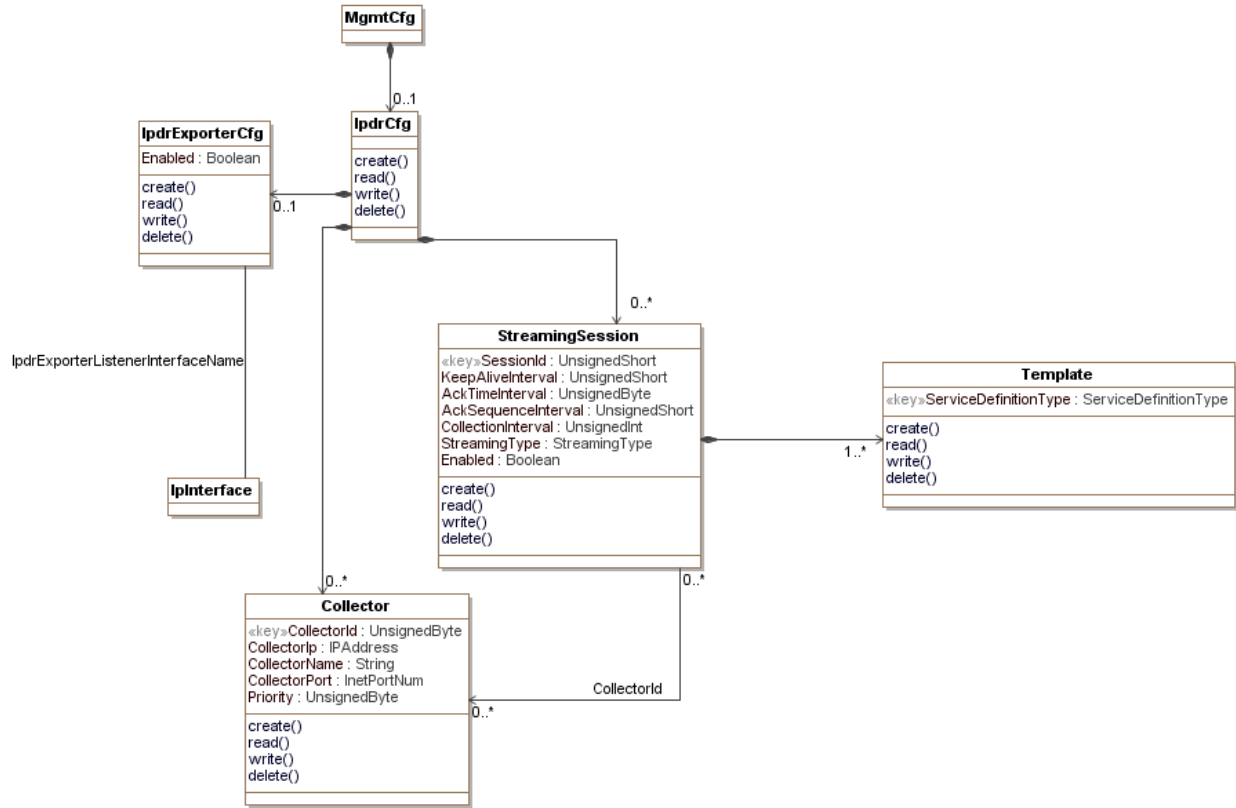

Figure 6-23 - IPDR Configuration Objects

#### 6.6.9.8.1 MgmtCfg

This configuration object is included in Figure 6-20 for reference. It is defined in Section 6.6.9.2, MgmtCfg.

#### 6.6.9.8.2 IpdrCfg

The IpdrCfg object is the container for the IPDR configuration objects. It has the following associations:

Table 6-279 - IpdrCfg Object Associations

Associated Object Name	Type	Near-end Multiplicity	Far-end Multiplicity	Label
IpdrExporterCfg	Directed composition to IpdrExporterCfg		0..1	
StreamingSession	Directed composition to StreamingSession		0..*	
Collector	Directed composition to Collector		0..*	

#### 6.6.9.8.3 IpdrExporterCfg

This configuration object allows an exporter to be turned on and off.

Table 6-280 - IpdrExporterCfg Object Attributes

Attribute Name	Type	Required Attribute	Type Constraints	Units	Default Value
Enabled	Boolean	No			true



**Table 6-281 - IpdrExporterCfg Object Associations**

Associated Object Name	Type	Near-end Multiplicity	Far-end Multiplicity	Label
IpInterface	Association with IpInterface			IpdrExporterListenerInterfaceName

When an IP interface is selected, this specifies the IP interface on which the IPDR server listens. If an IP interface is not specified, the behavior of the CCAP is vendor-specific.

#### 6.6.9.8.3.1 IpdrExporterCfg Object Attributes

##### 6.6.9.8.3.1.1 Enabled

This attribute configures whether or not the IPDR exporter is enabled.

#### 6.6.9.8.4 StreamingSession

This configuration object is used to configure global IPDR connection attributes. A typical use case is for a single Template to be associated with a StreamingSession.

**Table 6-282 - StreamingSession Object Attributes**

Attribute Name	Type	Required Attribute	Type Constraints	Units	Default Value
SessionId	UnsignedShort	Yes (Key)			
KeepAliveInterval	UnsignedShort	No		seconds	20
AckTimeInterval	UnsignedByte	No	1..60	seconds	30
AckSequenceInterval	UnsignedShort	No	1..500	records	200
CollectionInterval	UnsignedInt	Yes	0..86400	seconds	
StreamingType	Enum	Yes	other(1), timeInterval(2), adHoc(3), event(4), timeEvent(5)		
Enabled	Boolean	No			true

**Table 6-283 - StreamingSession Object Associations**

Associated Object Name	Type	Near-end Multiplicity	Far-end Multiplicity	Label
Template	Directed composition to Template		1..*	
Collector	Directed association to Collector	0..*	0..*	CollectorId

#### 6.6.9.8.4.1 StreamingSession Object Attributes

##### 6.6.9.8.4.1.1 SessionId

This attribute configures the ID for this session instance.

##### 6.6.9.8.4.1.2 KeepAliveInterval

This attribute configures the interval in seconds at which IPDR "keepalives" are sent from the CCAP IPDR exporter to the collector.

**6.6.9.8.4.1.3 AckTimeInterval**

This attribute configures the interval in seconds in which the CCAP IPDR exporter waits for an acknowledgment.

**6.6.9.8.4.1.4 AckSequenceInterval**

This attribute configures the maximum number of unacknowledged records that can be sent by the CCAP IPDR exporter before receiving an acknowledgement.

**6.6.9.8.4.1.5 CollectionInterval**

Where streaming is of the type `timeInterval`, this attribute configures the interval in seconds at which IPDR information is extracted from the CCAP management objects and transmitted to the collector.

Where streaming is of the type `timeEvent`, this attribute identifies the interval at which the CCAP IPDR exporter will close the IPDR session to allow IPDR session processing to occur. Records created by Service Definitions supporting `timeEvent` are sent when the event is generated.

**6.6.9.8.4.1.6 StreamingType<sup>59</sup>**

This attribute configures the type of IPDR streaming used for the session. See the IPDR Service Definition Schemas in Section 8 for the streaming types supported by each Service Definition. The value of `other(1)` is used when a vendor-extension has been implemented for this attribute.

**6.6.9.8.4.1.7 Enabled**

This attribute controls whether the IPDR Session is enabled or disabled.

**6.6.9.8.5 Template**

This configuration object allows the configuration of an individual IPDR session for a given IPDR connection.

**Table 6-284 - Template Object Attributes<sup>60</sup>**

Attribute Name	Type	Required Attribute	Type Constraints	Units	Default Value
ServiceDefinitionType	Enum	Yes (Key)	other(1), cmtsCmServiceFlowType(2), cmtsCmRegStatusType(3), cmtsCmUsStatsType(4), cmtsDsUtilStatsType(5), cmtsUsUtilStatsType(6), cmtsTopologyType(7), cpeType(8), diagLogType(9), diagLogDetailType(10), diagLogEventType(11), samisType1(12), samisType2(13), spectrumMeasurementType(14) ipMulticastStatsType(15) cmtsCmDsOfdmProfileStatusType(16) cmtsCmDsOfdmStatusType(17) cmtsCmUsOfdmaProfileStatusType(18) cmtsCmUsOfdmaStatusType(19) dsOfdmProfileStatsType(20) usOfdmaProfileStatsType(21)		

<sup>59</sup> Modified per CCAP-OSSv3.1-N-15.1307-3 on 6/1/15 by KB.

<sup>60</sup> Modified per CCAP-OSSv3.1-N-15.1390-2 on 11/11/15 by KB.

### 6.6.9.8.5.1 Template Object Attributes

#### 6.6.9.8.5.1.1 ServiceDefinitionType<sup>61</sup>

This attribute configures the service type definition for this IPDR session. See the IPDR Service Definition Schemas in Section 8 for the definitions and schemas of the types defined in this enumeration. The value of other(1) is used when a vendor-extension has been implemented for this attribute.

### 6.6.9.8.6 Collector

This configuration object allows the operator to configure an IPDR collector.

**Table 6-285 - Collector Object Attributes**

Attribute Name	Type	Required Attribute	Type Constraints	Units	Default Value
CollectorId	UnsignedByte	Yes (Key)			
CollectorIp	IpAddress	Yes			
CollectorName	String	No			""
CollectorPort	InetPortNum	No			4737
Priority	UnsignedByte	Yes			

### 6.6.9.8.6.1 Collector Object Attributes

#### 6.6.9.8.6.1.1 CollectorId

This key configures a unique identifier for this collector instance.

#### 6.6.9.8.6.1.2 CollectorIp

This attribute configures the IP address of collectors from which the CCAP will accept a connect. As per [OSSiv3.0], the collector establishes a connection to the CCAP.

#### 6.6.9.8.6.1.3 CollectorName

This attribute configures a name for the IPDR collector.

#### 6.6.9.8.6.1.4 CollectorPort

This attribute configures the port used by the collector to communicate with the CCAP. The default for this is 4737.

#### 6.6.9.8.6.1.5 Priority

This attribute configures the priority of this IPDR collector. The priority is used to elect the primary and active collector. The collector with the lowest priority is elected.

## 6.6.10 CCAP EPON Configuration Objects

For DOCSIS EPON provisioning and management, the CCAP MUST meet the requirements in [DPoE OSSiv1.0]. The EPON configuration objects are shown in the following diagram.

<sup>61</sup> Modified per CCAP-OSSiv3.1-N-15.1307-3 on 6/1/15 by KB.

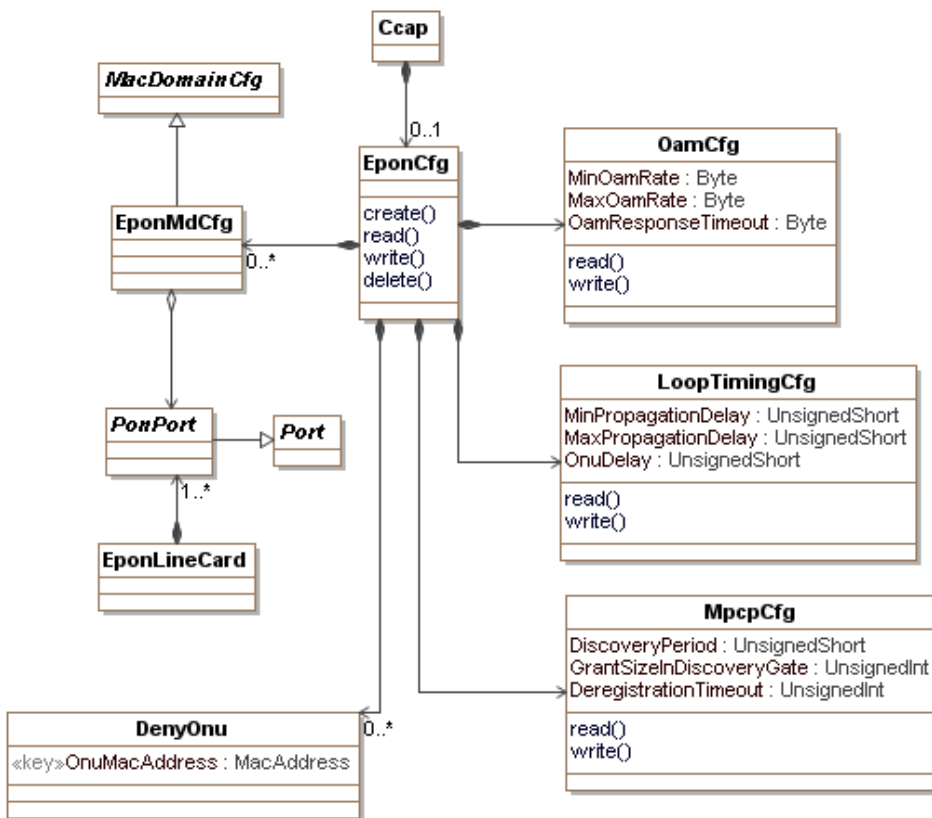

Figure 6-24 - EPON Configuration Objects

### 6.6.10.1 Ccap

This configuration object is included in Figure 6-24 for reference. It is defined in Section 6.6.3.1, Ccap Object.

### 6.6.10.2 EponCfg

The EponCfg object is the primary container of EPON configuration objects. It has the following associations:

Table 6-286 - EponCfg Object Associations

Associated Object Name	Type	Near-end Multiplicity	Far-end Multiplicity	Label
EponMdCfg	Directed composition to EponMdCfg		0..*	
OamCfg	Directed composition to OamCfg			
LoopTimingCfg	Directed composition to LoopTimingCfg			
MpcpCfg	Directed composition to MpcpCfg			
DenyOnu	Directed composition to DenyOnu		0..*	

### 6.6.10.3 OamCfg

This configuration object is taken from [DPoE OSSv1.0] and is used without modification for CCAP. This object controls the rate at which OAM messages are sent on the EPON interface.

Reference: [DPoE OSSv1.0], EPON OAM Configuration section

#### 6.6.10.4 LoopTimingCfg

This configuration object is taken from [DPoE OSSiv1.0] and is used with the following modifications for CCAP: the OltUpDownDelayOffset and NullGrantSize attributes have been removed.

This object configures the loop timing for EPON interfaces.

Reference: [DPoE OSSiv1.0], Loop Timing section

#### 6.6.10.5 MpcpCfg

This configuration object is taken from [DPoE OSSiv1.0] and is used without modification for CCAP. It configures the Multi-Point Control Protocol for EPON interfaces.

Reference: [DPoE OSSiv1.0], MPCP Configuration section

#### 6.6.10.6 EponMdCfg

This object defines a specialization of the MacDomain object for EPON interfaces.

**Table 6-287 - EponMdCfg Object Associations**

Associated Object Name	Type	Near-end Multiplicity	Far-end Multiplicity	Label
MacDomainConfig	Specialization of MacDomainCfg			
PonPort	Directed aggregation to PonPort			

#### 6.6.10.7 DenyOnu

This configuration object allows an operator to create a list of ONU MAC addresses that are not allowed to register.

**Table 6-288 - DenyOnu Object Attributes**

Attribute Name	Type	Required Attribute	Type Constraints	Units	Default Value
OnuMacAddress	MacAddress	Yes (Key)			

##### 6.6.10.7.1 DenyOnu Object Attributes

###### 6.6.10.7.1.1 OnuMacAddress

The MAC address of the ONU that will be added to the deny list. This attribute is used as a key.

#### 6.6.10.8 MacDomainCfg

This configuration object is included in Figure 6-24 for reference. It is defined in Section 6.6.6.6.6, MacDomainCfg.

#### 6.6.10.9 PonPort

This configuration object is included in Figure 6-24 for reference. It is defined in Section 6.6.4.20, PonPort.

#### 6.6.10.10 Port

This configuration object is included in Figure 6-24 for reference. It is defined in Section 6.6.4.10, Port.

### 6.6.10.11 EponLineCard

This configuration object is included in Figure 6-24 for reference. It is defined in Section 6.6.4.7, EponLineCard.

## 6.7 Status Monitoring and Control Requirements

### 6.7.1 Status Monitoring and Control UML Object Models

This section defines the object models for the utilization of CCAP status and control management functions. These objects are typically not used during installation when the CCAP is brought on-line and into service. Status and control management objects are used at run time to obtain status information or command actionable control. Examples of control functions include clearing an event log or starting a packet capture on a specific MAC Domain. Examples of status functions include checking the operational state of an interface or the results of a diagnostics test. In general, configuration of these control objects would not be included in the startup-config for initial CCAP device configuration.

#### 6.7.1.1 Fault Management Control Objects

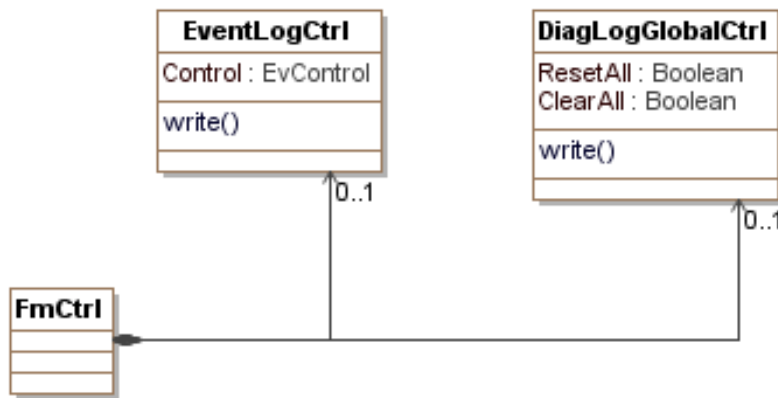

Figure 6-25 - Fault Management Control Objects

##### 6.7.1.1.1 FmCtrl

The FmCtrl object is the primary container of Fault Management Control objects. It has the following associations:

Table 6-289 - FmCtrl Object Associations

Associated Object Name	Type	Near-end Multiplicity	Far-end Multiplicity	Label
EventLogCtrl	Directed composition to EventLogCtrl		0..1	
DiagLogGlobalCtrl	Directed composition to DiagLogGlobalCtrl		0..1	

##### 6.7.1.1.1.1 EventLogCtrl

This control object is based on the docsDevEvent group defined in [RFC 4639] and contains a single actionable configuration attribute: Control. This object is used to clear the event log or to return all event priorities to their default settings.

Reference: [RFC 4639], docsDevEvControl object

6.7.1.1.1.2 DiagLogGlobalCtrl<sup>62</sup>

This control object is based on the LogGlobal object defined in Annex G and contains the following actionable configuration attributes:

- ResetAll
- ClearAll

This object allows Log and LogDetail instances to be reset or cleared.

Reference: Annex G.2.2, LogGlobal Object

6.7.1.2 Performance Management Control Objects<sup>63</sup>

The objects in the Performance Management Control class diagram are taken from the following DOCSIS MIBs and are used without modification for the CCAP:

Object	MIB
CmtsSpectrumAnalysisMeas	DOCS-IF3-MIB
CmtsSignalQualityExt	DOCS-IF3-MIB
CmtsCmCtrlCmd	DOCS-IF3-MIB
CmtsDebugDsid	DOCS-QOS3-MIB
ChgOverGroup	DOCS-LOADBAL3-MIB

Reference: [OSSiv3.0], [DOCS-IF3-MIB], [DOCS-QOS3-MIB], [DOCS-LOADBAL3-MIB]

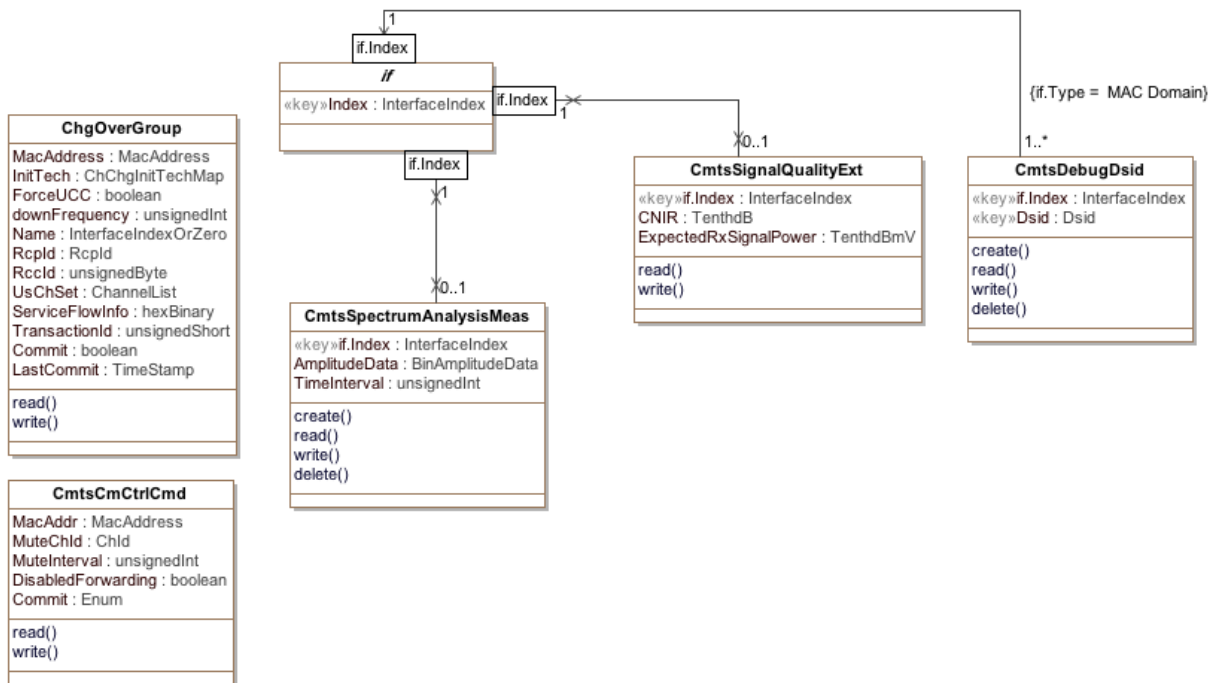

Figure 6-26 - Performance Management Control and Monitoring Information Model<sup>64</sup>

<sup>62</sup> Modified per CCAP-OSSiv3.1-N-15.1307-3 on 6/1/15 by KB.

<sup>63</sup> Modified per CCAP-OSSiv3.1-N-1433-1 on 5/13/16 by KB.

<sup>64</sup> Modified per CCAP-OSSiv3.1-N-16.1433-1 on 5/13/16 by KB.

### 6.7.1.2.1 CmtsSignalQualityExt<sup>65</sup>

This object provides metrics and parameters associated with received carrier, noise and interference power levels in the upstream channels of the CMTS.

**Table 6-290 - CmtsSignalQualityExt Object**

Attribute Name	Type	Access	Type Constraints	Units	Default
IfIndex	InterfaceIndex	key	Interface Index of logical upstream channel		
CNIR	TenthdB	read-only		TenthdB	
ExpectedRxSignalPower	TenthdBmV	read-only		TenthdBmV	

#### 6.7.1.2.1.1 IfIndex

This key represents the interface index of the logical upstream of the CMTS to which this instance applies.

#### 6.7.1.2.1.2 CNIR

This attribute provides an upstream in-channel Carrier-to-Noise plus Interference Ratio (CNIR). CNIR is defined as the ratio of the expected commanded received signal power at the CMTS input, assuming QPSK0 modulation, to the noise plus interference in the channel. This measurement occurs prior to the point at which the desired CM signal, when present, is demodulated. The measurement includes the effect of the receive matched filter but does not include the effect of any ingress filtering. Both the signal power and noise/interference power are referenced to the same point, e.g., CMTS input.

#### 6.7.1.2.1.3 ExpectedRxSignalPower

This attribute provides the power of the expected commanded received signal in the channel, referenced to the CMTS input.

### 6.7.1.2.2 CmtsSpectrumAnalysisMeas<sup>66</sup>

The CmtsSpectrumAnalysisMeas object was defined in previous versions of the DOCSIS OSSI specification to indicate how much desired signal, noise and interference energy exists within the channel by reporting frequency content information of energy within the channel. The CmtsSpectrumAnalysisMeas object includes interface index, amplitude of noise and a time interval indicator. The CmtsSpectrumAnalysisMeas object is deprecated and replaced with the Upstream Triggered Spectrum Capture objects defined in Section 7.3.5.1.6.

### 6.7.1.2.3 CmtsCmCtrlCmd

The CMTS CM Control Command object allows an operator to trigger the CMTS to send a CM-CTRL-REQ message to the specified CM with specific parameters.

The CMTS is not required to persist the values of the attributes of the CmtsCmCtrlCmd object across reinitializations.

References: [MULPIv3.1] Media Access Control Specification section.

**Table 6-291 - CmtsCmCtrlCmd Object**

Attribute Name	Type	Access	Type Constraints	Units	Default
MacAddr	MacAddress	read-write			'000000000000'H
MuteUsChId	ChId	read-write			0
MuteInterval	unsignedInt	read-write		milliseconds	0
DisableForwarding	boolean	read-write			false

<sup>65</sup> Modified per CCAP-OSSv3.1-N-16.1464-3 on 5/13/16 by KB.

<sup>66</sup> Modified per CCAP-OSSv3.1-N-16.1536-6 on 11/15/16 by KB.



Attribute Name	Type	Access	Type Constraints	Units	Default
Commit	Enum	read-write	mute(1) cmReinit(2) disableForwarding(3)		'mute'

#### 6.7.1.2.3.1 MacAddr

This attribute represents the MAC Address of the CM which the CMTS is instructed to send the CM-CTRL-REQ message.

#### 6.7.1.2.3.2 MuteUsChId

This attribute represents the Upstream Channel ID (UCID) to mute or unmute. A value of zero indicates all upstream channels. This attribute is only applicable when the Commit attribute is set to 'mute'.

#### 6.7.1.2.3.3 MuteInterval

This attribute represents the length of time that the mute operation is in effect. This attribute is only applicable when the Commit attribute is set to 'mute'. A value of 0 is an indication to unmute the channel referenced by the MuteUsChId attribute while a value of 0xFFFFFFFF is used to mute the channel referenced by the MuteUsChId attribute indefinitely.

#### 6.7.1.2.3.4 DisableForwarding

When set to 'true', this attribute disables data forwarding to the CMCI ports when the Commit attribute is set to 'disableForwarding'. When set to 'false', this attribute enables data forwarding to the CMCI ports when the Commit attribute is set to 'disableForwarding'. This attribute is only applicable when the Commit attribute is set to 'disableForwarding'.

#### 6.7.1.2.3.5 Commit

This attribute indicates the type of command for the CMTS to trigger in the CM-CTRL-REQ message. This attribute will return the value of the last operation performed or the default if no operation has been performed.

#### 6.7.1.2.4 ChgOverGroup

This object represents the Externally-Directed Load Balancing command interface. This object provide the controls of change-over operations for CMs. A change-over operation consist of externally-initiated requests to change the CM downstream and/or upstream channel configuration using DOCSIS MAC Message mechanism such as UCC, DCC, DBC or combinations of them. Committed change-over operations are reported in the ChgOverStatus object.

**Table 6-292 - ChgOverGroup Object**

Attribute Name	Type	Access	Type Constraints	Units	Default
MacAddress	MacAddress	read-write	Mandatory		'000000000000'H
InitTech	ChChgInitTechMap	read-write			'F8'H
ForceUCC	boolean	read-write			false
DownFrequency	unsignedInt	read-write		Hertz	0
MdlfIndex	InterfaceIndexOrZero	read-write			0
Rcpld	Rcpld	read-write			'0000000000'H
Rcclد	unsignedByte	read-write			0
UsChSet	ChannelList	read-write			"H
ServiceFlowInfo	hexBinary	read-write	SIZE (0..128)		"H
TransactionId	unsignedShort	read-write			0
Commit	boolean	read-write			'false'
LastCommit	TimeStamp	read-only			0

#### 6.7.1.2.4.1 MacAddress

This attribute represents the MAC address of the cable modem that the CMTS instructs to move to a new downstream and/or upstream channel set.

#### 6.7.1.2.4.2 InitTech

This attribute represents the initialization technique that the cable modem is instructed to use when performing multiple-channel change-over operation. The value of this attribute applies to all upstream channels in the channel set.

#### 6.7.1.2.4.3 ForceUCC

This attribute when set to 'true' indicates that the CMTS forces UCC messages instead of DCC messages in those scenarios that are allowed as defined in the "Upstream Channel Change Request (UCC-REQ)" section of [MULPIv3.1]. In some cases the CMTS may still use UCC commands even though this attribute value is 'false', for example in an upstream-only change-over operation directed to a CM that the CMTS is aware is only capable of UCC, but the operator is not aware of the CM capabilities. This attribute value is ignored when the target CM for the change-over operation is in MRC mode, or the UsChSet attribute is the zero-length string, or the operation includes changes for downstream channels.

#### 6.7.1.2.4.4 DownFrequency

This attribute represents a single-downstream frequency to which the cable modem is instructed to move using a DCC request. The value zero indicates that this attribute is ignored during a commit operation.

#### 6.7.1.2.4.5 MdIfIndex

This attribute describes the MAC Domain Interface index of the triplet: Mac Domain, RCP-ID and RCC Status Index of the RccStatus object that represents the RCC used in the change-over operation. This MAC Domain Interface Index is also used to provide context for the UsChSet and ServiceFlowInfo attributes.

#### 6.7.1.2.4.6 Rcpld<sup>67</sup>

This attribute describes the RCP-ID of the triplet: Mac Domain, RCP-ID and RCC Status Index of the RccStatus object that represents the RCC used in the change-over operation. If the RCP-ID is unknown or the CM is in DOCSIS 3.1 mode, the CMTS returns a five octet long string of zeros.

#### 6.7.1.2.4.7 RcclD<sup>68</sup>

This attribute describes the RCC Status Index of the triplet: Mac Domain, RCP-ID and RCC Status Index of the RccStatus object that represents the RCC used in the change-over operation. If the RCC-ID is unknown or the CM is in DOCSIS 3.1 mode, the CMTS returns a value of zero.

#### 6.7.1.2.4.8 UsChSet

This attribute describes the Channel list (within the context of the MAC domain identified by MdIfIndex) that represents the final TCS expected from the change-over operation.

When the operation is intended for an RCC-only, this attribute is set to zero and the attribute InitTech is ignored.

#### 6.7.1.2.4.9 ServiceFlowInfo

This attribute provides a list of Service Flow ID-Channel Set ID pairs used to control Service Flow assignment in the change-over operation. This is intended as an override to the normal assignment based on SF attributes. This attribute is encoded as a series of 32-bit pairs as follows:

---

<sup>67</sup> Modified by CCAP-OSSv3.1-N-15.1335-1 on 8/7/15 by KB.

<sup>68</sup> Modified by CCAP-OSSv3.1-N-15.1335-1 on 8/7/15 by KB.

- The first four bytes correspond to the value of the Service Flow ID (attribute Id of the ServiceFlow object of the DOCSIS QoS objects).
- The last four bytes correspond to the value of the attribute ChSetId of the UsChSet or DsChSet object of the CMTS Bonding Objects.

If this attribute does not include tuples for some of the CM's Service Flows, the CMTS determines the respective channels based on SF attributes. Service Flow ID-Channel Set ID pairs matching upstream service flows are ignored if the change-over operation does not affect the TCC of the CM. Similarly, Service Flow ID-Channel Set ID pairs matching downstream service flows are ignored if the change-over operation does not affect the RCC of the CM.

#### 6.7.1.2.4.10 TransactionId

This attribute represents an operator identifier for the change-over operation to be used to correlate logged information in the ChangeOver3 Status object. The CMTS uses this value as the Transaction ID in the DBC-REQ or DCC-REQ message transmitted in association with this operation. If this value is set to zero the CMTS defines its own MAC message Transaction ID value.

#### 6.7.1.2.4.11 Commit

This attribute when set to 'true' triggers the change-over operation for Externally-Directed Load Balancing.

Setting this attribute to 'true' is known as a commit operation. A commit operation is considered successful if the CMTS considers that the entered information is valid and the transaction can be initiated. It does not imply that the channel-change operation itself (i.e., UCC, DCC, DBC transaction) reports success or completion. A commit operation is considered unsuccessful if the CMTS determines that there are invalid attributes values in the ChangeOver object such that the change-over operation cannot be initiated.

Some examples for a change-over that cannot be initiated are:

- Attempt to send a DBC for MRC that does not fit the CM RCP.
- Attempt to send a DCC while a previous one is still in progress.
- Attempt to send a UCC to a channel ID that is not defined.

After system initialization all ChangeOver object parameters are set to default values.

After a successful commit operation all ChangeOver object parameters are set to default values with the exception of this attribute (commit) that is set to 'true'. An unsuccessful commit operation is rejected and this attribute reports false in subsequent value queries.

After a successful commit operation, the CMTS initiates the change-over transaction using the most appropriate technique. The potential techniques are:

- UCC - For upstream-channel-only changes on CMs not operating in MRC mode.
- DCC - For upstream and/or downstream channel changes on CMs not operating in MRC mode, as well as upstream only change for CMs operating in MRC mode but with no TCS conveyed during registration.
- DCC followed by channel assignment in REG-RSP-MP - For MAC Domain re-assignment on CMs operating in MRC mode. In this case, the change-over command might only include a downstream frequency, or might include an RCC defined in the target MAC domain. The upstream channel set may or may not be provided. The only applicable Initialization Technique for this operation is 'reinitializeMAC'.
- DBC - For change in the TCS and/or RCS on CMs operating in MRC mode.

#### 6.7.1.2.4.12 LastCommit

The value of sysUpTime when the attribute Commit was last set to true. Zero if never set.

#### 6.7.1.2.5 CmtsDebugDsid

The CMTS Debug DSID object contains the control of DSID debug statistics reporting

An instance in this object defines the DSID and MAC domain to which the CmtsDebugDsidStats collects statistics for the downstream channel associated with that DSID and MAC Domain. The deletion of an instance stops the reporting of statistics for the specified DSID.

This object supports instance creation and deletion.

The CMTS MUST support at least one instance of the CmtsDebugDsid object. Creation of a new instance of this object requires a valid MAC Domain and a current DSID value.

The CMTS MUST NOT persist instances created in the CmtsDebugDsid object across system reinitializations.

**Table 6-293 - CmtsDebugDsid Object**

Attribute Name	Type	Access	Type Constraints	Units	Default
IfIndex	InterfaceIndex	key			
Dsid	Dsid	key			

**6.7.1.2.5.1 IfIndex**

This attribute represents the interface index of the MAC Domain to which an instance of this object applies.

**6.7.1.2.5.2 Dsid**

This attribute represents the DSID value to be debugged, identified by the IfIndex attribute of this object.

**6.7.1.3 IETF Status Monitoring and Control Objects<sup>69</sup>**

The objects in the IETF Status Monitoring and Control class diagram are taken from the following IETF MIBs and are used without modification for the CCAP:

Object	MIB
routerInterface	MGMD-MIB
routerCache	MGMD-MIB

**6.7.1.3.1 Application of IETF Multicast MIB (MGMD-MIB)**

DOCSIS 3.1 defines three methods for forwarding multicast traffic [MULPIv3.1]. The first method is referred to as DSID-based Multicast Forwarding. In this mode, the CCAP, not the CM, controls the forwarding of multicast traffic to CPE devices behind the CM. The second method is called GMAC Explicit Multicast Forwarding. In this mode, a DSID is used for filtering downstream packets and for some forwarding of multicast, but the CCAP also includes a GMAC address for the IP Multicast Group to allow the CM to utilize some hardware forwarding assistance. When the CM is operating in GMAC Explicit forwarding mode, the CM plays a completely passive role in the IGMP or MGMD framework and passes all membership traffic and related messages to the CCAP. The final forwarding mode is MDF Disabled. In this mode, the CM acts as it did in DOCSIS 2.0 and snoops the IGMP membership and related messages.

A CCAP that supports MGMD supports the MGMD-STD-MIB [RFC 5519]. As such, this section describes the application of the IETF [RFC 5519] to MGMD devices. The tables in the MGMD-STD- MIB [RFC 5519] have been condensed to two tables, with additional MIB objects added to match the IGMP-STD-MIB defined in [RFC 2933]. The MGMD MIB will also include information about MLD (Multicast Listener Discovery) from [RFC 3019] to support IPv6.

The MGMD-STD-MIB [RFC 5519] is organized into two distinct tables; the interface and cache tables. The MGMD Interface Table contains entries for each interface that supports MGMD on a device. This includes the NSI and HFC interfaces for the CCAP. The MGMD Cache Table contains one row for each IP Multicast Group for which there

<sup>69</sup> Subsections modified per CCAP-OSSv3.1-N-15.1307-3 on 6/1/15 by KB.

are active members on a given interface. If the CCAP is implemented as a Multicast router, active multicast group membership MAY exist on both the NSI and HFC interfaces.

Support of the MGMD-STD-MIB [RFC 5519] is presented in terms of MGMD capabilities supported by the CCAP.

The CCAP MUST support the mgmdRouterInterfaceTable, mgmdRouterCacheTable, mgmdInverseRouterCacheTable and the mgmdRouterSrcListTable from the MGMD-STD-MIB [RFC 5519] within each MAC Domain where IP multicast is forwarded.

The CCAP MAY support the mgmdRouterInterfaceTable and the mgmdRouterCacheTable read-write objects as writeable (configurable via SNMP management interface).

## 7 PERFORMANCE MANAGEMENT

### 7.1 Performance Management Requirements and Transport Protocols<sup>70</sup>

At the CATV MAC and PHY layers, performance management focuses on the monitoring of the effectiveness of cable plant segmentation and rates of upstream traffic and collisions. Instrumentation is provided in the form of the standard interface statistics [RFC 2863] and service queue statistics (from [RFC 4546]). It is not anticipated that the CCAP upstream bandwidth allocation function will require active network management intervention and tuning.

At the LLC layer, the performance management focus is on bridge traffic management. If the CCAP implements transparent bridging, it implements the Bridge MIB [RFC 4188].

The CCAP diagnostic log capabilities, as described in Annex G, provides early detection of CM and cable plant problems.

The DOCS-IF-MIB [RFC 4546] includes variables to track PHY state such as codeword collisions and corruption, signal-to-noise ratios, transmit and receive power levels, propagation delays, micro-reflections, in channel response, and sync loss. The DOCS-IF-MIB [RFC 4546] also includes counters to track MAC state, such as collisions and excessive retries for requests, immediate data transmits, and initial ranging requests. Section 6.7.1.2 provides enhanced signal quality monitoring and diagnostic capabilities for detecting cable plant.

A final performance concern is the ability to diagnose unidirectional loss. The CCAP implements the MIB-II [RFC 1213] Interfaces Group [RFC 2863] as specified in Annex A.

#### 7.1.1 SNMP and MIB Requirements<sup>71</sup>

Since CCAP configuration will be primarily accomplished via the standard XML configuration file and legacy CLI commands, SNMP is not used as a primary configuration interface on the CCAP. Based on this, most CCAP MIB objects will be used in a read-only mode for status and performance monitoring. Refer to Annex A for a detailed set of SNMP MIB object requirements

The CCAP requires a very small set of read-create or read-write MIB objects used by operators for operational control, automation or testing tasks.

The CMTS and CCAP MAY augment the required MIBs with objects from other standard or vendor-specific MIBs where appropriate.

The CMTS and CCAP MUST implement the MIB requirements in accordance with this specification regardless of the value of an IETF MIB object's status (e.g., deprecated or optional).

If not required by this specification, deprecated objects are optional. If a CMTS or CCAP implements a deprecated MIB object, the CMTS or CCAP MUST implement the MIB object correctly according to the MIB definition.

If a CMTS does not implement a deprecated MIB object, the following conditions MUST be met:

- The CMTS or CCAP MUST NOT instantiate the deprecated MIB object.
- The CMTS or CCAP MUST respond with the appropriate error/exception condition, such as noSuchObject for SNMPv2c, when an attempt to access the deprecated MIB object is made.

If not required by this specification, additional objects are optional. If a CMTS or CCAP implements any additional MIB objects, the CMTS or CCAP MUST implement the MIB object correctly according to the MIB definition.

If a CMTS does not implement one or more additional objects, the following conditions MUST be met:

- The CMTS or CCAP MUST NOT instantiate the additional MIB object or objects.
- The CMTS or CCAP MUST respond with the appropriate error/exception condition, such as noSuchObject for SNMPv2c, when an attempt to access the non-existent additional MIB object is made.

<sup>70</sup> Modified per CCAP-OSSv3.1-N-15.1307-3 on 6/1/15 by KB.

<sup>71</sup> Modified per CCAP-OSSv3.1-16.1635-1 on 11/17/16 by KB.

If not required by this specification, obsolete objects are optional. If a CMTS or CCAP implements an obsolete MIB object, the CMTS or CCAP MUST implement the MIB object correctly according to the MIB definition.

If a CMTS or CCAP does not implement an obsolete MIB object, the following conditions MUST be met:

- The CMTS or CCAP MUST NOT instantiate the obsolete MIB object.
- The CMTS or CCAP MUST respond with the appropriate error/exception condition, such as noSuchObject for SNMPv2c, when an attempt to access the obsolete MIB object is made.

Objects which are not supported by this specification are not implemented by an agent.

- The CMTS and CCAP MUST NOT instantiate not supported MIB objects.
- The CMTS and CCAP MUST respond with the appropriate error/exception condition, such as noSuchObject for SNMPv2c, when an attempt to access a not supported MIB object is made.

The CMTS and CCAP MUST implement the MIB access requirements defined in Annex A as follows:

- MIB objects with Not-Accessible (N-Acc) access type are implemented with not-accessible access and are typically indexes in MIB tables.
- MIB objects with Read-Create (RC) access type are implemented with read-create access.
- MIB objects with Read-Write (RW) access type are implemented with read-write access.
- MIB objects with Read-Only (RO) access type are implemented with read-only access.
- MIB objects with Read-Create (RC) access type are implemented with read-create access.
- MIB objects with Read-Create (RC) or Read-Only (RO) access types are implemented with either read-create access or read-only access as described in the object.
- MIB objects with Read-Create (RC) or Read-Write (RW) access types are implemented with either read-create access or read-write access as described in the object.
- MIB objects with Read-Write (RW) or Read-Write (RO) access types are implemented with either read-write access or read-only access as described in the object.
- MIB objects with Accessible for SNMP Notification (Acc-FN) access type are implemented as SNMP Notifications or Traps.

### 7.1.1.1 Protocol and Agent Requirements

The CMTS and CCAP MUST support the SNMPv1 and SNMPv2c protocol.

The CMTS and CCAP MAY support the SNMPv3 protocol.

The CCAP MUST support at least 10 SNMP Community strings with controlled access via access lists.

The IETF SNMP-related RFCs listed in Table 7-1 are supported by the CCAP and CMTS.

**Table 7-1 - IETF SNMP-related RFCs**

[RFC 3410]	Introduction and Applicability Statements for Internet Standard Management Framework
[RFC 3411]	An Architecture for Describing Simple Network Management Protocol (SNMP) Management Frameworks
[RFC 3412]	Message Processing and Dispatching for the Simple Network Management Protocol (SNMP)
[RFC 3413]	Simple Network Management Protocol (SNMP) Applications
[RFC 3414]	User-based Security Model (USM) for version 3 of the Simple Network Management Protocol (SNMPv3)
[RFC 3415]	View-based Access Control Model (VACM) for the simple Network Management Protocol (SNMP)
[RFC 3416]	Version 2 of the Protocol Operations for the Simple Network Management Protocol (SNMP)
[RFC 3417]	Transport Mappings for the Simple Network Management Protocol (SNMP)
[RFC 3418]	Management Information Base for the Simple Network Management Protocol (SNMP)
[RFC 3419]	Textual Conventions for Transport Addresses

[RFC 3584]	Coexistence between Version 1, Version 2, and Version 3 of the Internet-standard Network Management Framework
[RFC 3826]	The Advanced Encryption Standard (AES) Cipher Algorithm in the SNMP User-based Security Model
[RFC 1901]	Introduction to Community-based SNMPv2 (Informational)
[RFC 1157]	A Simple Network Management Protocol

For support of SMIv2, Table 7-2 lists the IETF SNMP-related RFCs which are supported by the CCAP and CMTS.

**Table 7-2 - SMIv2 IETF SNMP-related RFCs**

[RFC 2578]	Structure of Management Information Version 2 (SMIv2)
[RFC 2579]	Textual Conventions for SMIv2
[RFC 2580]	Conformance Statements for SMIv2

For support of Diffie-Helman Key exchange for the User Based Security Model, Table 7-3 lists the IETF SNMP-related RFC which is optionally supported by the CCAP and CMTS.

**Table 7-3 - Diffie-Helman IETF SNMP-related RFC**

[RFC 2786]	Diffie-Helman USM Key Management Information Base and Textual Convention
------------	--

#### 7.1.1.1.1 CMTS and CCAP SNMP Modes of Operation

CMTS SNMP Coexistence Mode is subject to the following requirements and limitations:

- The CMTS MUST process SNMP v1/v2c Packets as described in [RFC 3411] through [RFC 3415] and [RFC 3584].
- If the CMTS supports the SNMPv3 protocol, it MUST process SNMP v3 Packets as described in [RFC 3411] through [RFC 3415] and [RFC 3584].
- SNMP Access control is determined by the SNMP-COMMUNITY-MIB [RFC 3584], and SNMP-TARGET-MIB [RFC 3413], SNMP-VIEW-BASED-ACM-MIB [RFC 3415], and SNMP-User-Based-SM-MIB [RFC 3414].
- The CMTS MUST support the SNMP-COMMUNITY-MIB [RFC 3584], which controls SNMPv1/v2c packet community string associations to a security name to select entries for access control in the SNMP-VIEW-BASED-ACM-MIB [RFC 3415].
- The CMTS SHOULD support the SNMP-USER-BASED-SM-MIB [RFC 3414] and SNMP-VIEW-BASED-ACM-MIB [RFC 3415] to control SNMPv3 packets.
- The CMTS MUST support SNMP Notification destinations as specified in the SNMP-TARGET-MIB and SNMP-NOTIFICATION-MIB [RFC 3413].

The CMTS MAY support SNMPv3 with AES encryption as defined in [RFC 3826].

#### 7.1.1.1.2 CMTS and CCAP SNMP Access Control Configuration

The CMTS SNMP access control initial configuration is outside of the scope of this specification. If the CMTS supports SNMPv3, the CMTS MUST support the SNMPv3 key change mechanism defined in [RFC 3414].

Note that the SNMPv3 Initialization and Key Change process is based on [RFC 2786] which always configures the SNMP agent with SNMPv3 HMAC-MD5-96 as the authentication protocol and CBC-DES as the privacy protocol, both specified in [RFC 3414]. Therefore, this specification does not provide a mechanism to initialize SNMPv3 using CFB128-AES-128 for privacy key, as defined in [RFC 3826] or any other configuration defined in [RFC 3414] and are left out of scope of this specification.

[RFC 2786] provides a mechanism to kick start an SNMPv3 agent User-based Security Model [RFC 3414] and extensions to the same model for key change. [RFC 2786] does not define the mechanism to configure the initial key material for the kick start process.



### 7.1.1.1.3 IPv6 Transport Requirements

Several transport domains were initially defined for SNMP (see [RFC 3417]). To support IPv6, [RFC 3419] adds a new set of transport domains not only for SNMP but for any application protocol.

The CMTS and CCAP MUST support the recommendations of [RFC 3419] to support SNMP over IPv6.

### 7.1.1.2 CableLabs MIBs

**Table 7-4 - CableLabs MIBs**

Reference	MIB Module	Applicable Device
[DOCS-IFEXT2-MIB]	DOCSIS Interface Extension 2 MIB Module: DOCS-IFEXT2-MIB	CMTS/CCAP
[CLAB-TOPO-MIB]	CableLabs Topology MIB Module: CLAB-TOPO-MIB	CMTS/CCAP
[DOCS-DIAG-MIB]	DOCSIS Diagnostic Log MIB Module: DOCS-DIAG-MIB	CMTS/CCAP
[DOCS-IF3-MIB]	DOCSIS Interface 3 MIB Module: DOCS-IF3-MIB	CMTS/CCAP
[DOCS-MCAST-MIB]	DOCSIS Multicast MIB Module: DOCS-MCAST-MIB	CMTS/CCAP
[DOCS-MCAST-AUTH-MIB]	DOCSIS Multicast Authorization MIB Module: DOCS-MCAST-AUTH-MIB	CMTS/CCAP
[DOCS-QOS3-MIB]	DOCSIS Quality of Service 3 MIB Module: DOCS-QOS3-MIB	CMTS/CCAP
[DOCS-SEC-MIB]	DOCSIS Security MIB Module: DOCS-SEC-MIB	CMTS/CCAP
[DOCS-SUBMGT3-MIB]	DOCSIS Subscriber Management 3 MIB Module: DOCS-SUBMGT3-MIB	CMTS/CCAP
[DOCS-LOADBAL3-MIB]	DOCSIS Load Balancing 3 MIB Module: DOCS-LOADBAL3-MIB	CMTS/CCAP
[CCAP-MIB]	DOCSIS CCAP MIB Module: CCAP-MIB	CCAP
[M-OSSI], [DRFI]	DOCSIS DRF MIB Module: DOCS-DRF-MIB	CMTS/CCAP
[DOCS-PNM-MIB]	DOCSIS PNM MIB Module: DOCS-PNM-MIB	CCAP

The CCAP MUST support read-only access for all CMTS Mandatory ("M") MIB objects that have an SNMP access type of read-only ("RO") in Annex A.1-A.3 and Annex A of [L2VPN].

The CCAP MUST support read-only access for all CMTS Mandatory ("M") MIB objects that have an SNMP access type of read-write ("RW") or read-create ("RC") in Annex A.1-A.3 and Annex A of [L2VPN].

The CCAP MAY support read-write access for all CMTS Mandatory ("M") MIB objects that have an SNMP access type of read-write ("RW") in Annex A.1-A.3 and Annex A of [L2VPN].

The CCAP MAY support read-create access for all CMTS Mandatory ("M") MIB objects that have an SNMP access type of read-create ("RC") in Annex A.1-A.3 and Annex A of [L2VPN].

The CCAP MUST support read-only access for all Mandatory ("M") MIB objects that have an SNMP access type of read-only ("RO") in Annex A.4.

The CCAP MUST support read-write access for all Mandatory ("M") MIB objects that have an SNMP access type of read-write ("RW") or of read-create ("RC") in Annex A.4.

The CCAP-MIB defines the following:

- Objects which provide a link between an identifier of a CCAP interface used in the XML configuration file and its corresponding standard ifIndex MIB object from the ifTable and entPhysicalIndex MIB object from the Entity-MIB.
- Objects which can be used for video input program bitrate monitoring. Both the input program bitrate and input program requested bitrate can be accessed.

**7.1.1.3 SCTE MIBs**

The CCAP MUST support all mandatory MIB objects specified in the tables in Annex A, Detailed MIB Requirements (Normative).

For video sessions created via static configuration (e.g., via XML configuration file), the CCAP MUST instantiate the appropriate row entries in the SCTE-HMS-MPEG-MIB's mpegProgramMappingTable, mpegVideoSessionTable, mpegVideoSessionPtrTable, and mpegInputTSOutputSessionTable. For video sessions created via static configuration (e.g., via XML configuration file), the CCAP MUST set mpegVideoSessionProvMethod to tableBased (1).

For video sessions created via dynamic signaling (e.g., via ERMI), the CCAP MUST instantiate the appropriate row entries in the SCTE-HMS-MPEG-MIB's mpegProgramMappingTable, mpegVideoSessionTable, mpegVideoSessionPtrTable, and mpegInputTSOutputSessionTable. For video sessions created via dynamic signaling (e.g., via ERMI), the CCAP MUST set mpegVideoSessionProvMethod to sessionBased (2).

The CCAP MUST implement the mpegSessionsGroup table of SCTE-HMS-MPEG-MIB, which is defined as optional in [SCTE 154-4].

The CCAP SHOULD support all optional MIB objects specified in the tables in Annex A, Detailed MIB Requirements (Normative).

For an example of identifying a replication QAM via the SCTE-HMS-MPEG-MIB, see Appendix II.1; Identifying Replicated QAMs.

**7.1.1.4 IETF MIBs**

**Table 7-5 - IETF RFC MIBs<sup>72</sup>**

Reference	MIB Module	Applicable Device(s)
[RFC 2786]	Diffie-Helman USM Key MIB Module: SNMP-USM-DH-OBJECTS-MIB	CMTS/CCAP
[RFC 2790]	Host Resources MIB Module: HOST-RESOURCES-MIB	CMTS/CCAP
[RFC 2863]	Interfaces Group MIB Module: IF-MIB	CMTS/CCAP
[RFC 3410] [RFC 3411] [RFC 3412] [RFC 3413] [RFC 3414] [RFC 3415] [RFC 3484]	SNMPv3 MIB Modules: SNMP-FRAMEWORK-MIB, SNMP-MPD-MIB, SNMP-NOTIFICATION-MIB, SNMP-TARGET-MIB, SNMP-USER-BASED-SM-MIB, SNMP-VIEW-BASED-ACM-MIB, SNMP-COMMUNITY-MIB	CMTS/CCAP
[RFC 3418]	SNMPv2 MIB Module: SNMPv2-MIB	CMTS/CCAP
[RFC 3433]	Entity Sensor MIB Module: ENTITY-SENSOR-MIB	CMTS/CCAP
[RFC 3635]	Ethernet Interface MIB Module: EtherLike-MIB	CMTS/CCAP
[RFC 4022]	Transmission Control Protocol MIB Module: TCP-MIB	CMTS/CCAP

<sup>72</sup> Modified per CCAP-OSSv3.1-N-15.1307-3 on 6/1/15 by KB.

Reference	MIB Module	Applicable Device(s)
[RFC 4113]	User Datagram Protocol MIB Module: UDP-MIB	CMTS/CCAP
[RFC 4131]	DOCSIS Baseline Privacy Plus MIB Module: DOCS-IETF-BPI2-MIB	CMTS/CCAP
[RFC 4133]	Entity MIB Module: ENTITY-MIB	CMTS/CCAP
[RFC 4188]	Bridge MIB Module: BRIDGE-MIB	CMTS/CCAP
[RFC 4293]	Internet Protocol MIB Module: IP-MIB	CMTS/CCAP
[RFC 4546]	DOCSIS RF MIB Module: DOCS-IF-MIB	CMTS/CCAP
[RFC 4639]	DOCSIS Device MIB Module: DOCS-CABLE-DEVICE-MIB	CMTS/CCAP
[RFC 5132]	IP Multicast MIB Module: IPMCAST-MIB	CMTS/CCAP
[RFC 5519]	Multicast Group Membership Discovery MIB: MGMD-STD-MIB	CMTS/CCAP

The DOCSIS OSSI 3.1 specifications have priority over the IETF MIBs and all objects. Though deprecated or optional in the IETF MIB, the object can be required by this specification as mandatory.

#### 7.1.1.5 Specific MIB Object Implementation Requirements

The CMTS and CCAP MUST implement the compliance and syntax of the MIB objects as specified in Annex A.

The CMTS and CCAP MUST support a minimum of 10 available SNMP table rows, unless otherwise specified by RFC or DOCSIS specification.

The CMTS and CCAP minimum number of available SNMP table rows SHOULD mean rows (per table) that are available to support device configuration.

The CMTS and CCAP used (default) SNMP table row entries MUST NOT apply to the minimum number of available SNMP table rows.

##### 7.1.1.5.1 Treatment and Interpretation of MIB Counters

Octet and packet counters implemented as counter32 and counter64 MIB objects are monotonically increasing positive integers with no specific initial value and a maximum value based on the counter size that will roll-over to zero when it is exceeded. In particular, counters are defined such that the only meaningful value is the difference between counter values as seen over a sequence of counter polls. However, there are two situations that can cause this consistent monotonically increasing behavior to change: 1) resetting the counter due to a system or interface reinitialization or 2) a rollover of the counter when it reaches its maximum value of  $2^{32}-1$  or  $2^{64}-1$ . In these situations, it needs to be clear what the expected behavior of the counters should be.

**Case 1:** The state of an interface changes resulting in an "interface counter discontinuity" as defined in [RFC 2863].

In the case where the state of an interface within the CMTS and CCAP changes resulting in an "interface counter discontinuity" [RFC 2863], the CMTS and CCAP value of the `ifXTable.ifXEntry.ifCounterDiscontinuityTime` for the affected interface MUST be set to the current value of `sysUpTime` and ALL counters for the affected interface set to ZERO. When setting the `ifAdminStatus` of the affected interface to `down(2)`, the CMTS and CCAP MUST NOT consider this as an interface reset.

**Case 2:** SNMP Agent Reset.

An SNMP Agent Reset is defined as the reinitialization of the SNMP Agent software caused by a device reboot or device reset initiated through SNMP.

In the case of an SNMP Agent Reset within the CMTS or CCAP, the CMTS or CCAP MUST:

- set the value of sysUpTime to zero (0)
- set all interface ifCounterDiscontinuityTime values to zero (0)
- set all interface counters to zero (0)
- set all other counters maintained by the CMTS/CCAP SNMP Agent to zero (0).

**Case 3: Counter Rollover.**

When a counter32 object within the CMTS or CCAP reaches its maximum value of 4,294,967,295, the next value MUST be ZERO. When a counter64 object within the CMTS or CCAP reaches its maximum value of 18,446,744,073,709,551,615, the next value MUST be ZERO.

**NOTE:** Unless a CMTS or CCAP vendor provides a means outside of SNMP to preset a counter64 or counter32 object to an arbitrary value, it will not be possible to test any rollover scenarios for counter64 objects (and many counter32 objects as well). This is because it is not possible for these counters to rollover during the service life of the device (see discussion in section 3.1.6 of [RFC 2863]).

*7.1.1.5.2 Requirements for DOCSIS Device MIB [RFC 4639]*

The CMTS and CCAP MUST implement [RFC 4639].

**NOTE:** [RFC 4639] includes Compliance requirements for DIFFSERV-MIB [RFC 3289] to support IPv6 filtering as a replacement for the deprecated docsDevFilterIpTable. For backwards compatibility, this specification has requirements for docsDevFilterIpTable. IPv6 filtering requirements are specified in Annex A. This specification does not define requirements for [RFC 3289].

Additional requirements affecting [RFC 4639] are also found in [CM-OSSv3.1], Protocol Filtering.

*7.1.1.5.3 Requirements for DOCSIS RF MIB [RFC 4546]<sup>73</sup>*

The CCAP MUST implement [RFC 4546]. However, much of [RFC 4546] is not applicable to OFDM/OFDMA channels. Thus, this section defines separate requirements for handling both SC-QAM and OFDM/OFDMA channels.

The CCAP MUST instantiate a row entry for all SC-QAM and OFDM channels in the docsIfDownChannelTable. The CCAP MUST return appropriate values for all columns of the docsIfDownChannelTable for SC-QAM channels as described in the MIB itself and further specified in this section.

OFDM channels are defined and configured differently than SC-QAM channels. Thus, the docsIfDownChannelTable cannot properly represent OFDM channels. However, it is useful for the NMS to have some representation of OFDM channels in the docsIfDownChannelTable as an indication that the channel exists and that more information can be found in other tables. Thus, rules are defined for OFDM channels to provide standard data via the docsIfDownChannelTable.

The CCAP MUST report the following values (Table 7-6) for OFDM channel row entries in the docsIfDownChannelTable:

**Table 7-6 - docsIfDownChannelTable Requirements for OFDM Channels**

MIB Object	Value
docsIfDownChannelFrequency	0
docsIfDownChannelWidth	0
docsIfDownChannelModulation	other(2)
docsIfDownChannelInterleave	other(2)
docsIfDownChannelPower	0
docsIfDownChannelAnnex	other(2)
docsIfDownChannelStorageType	other(2)

<sup>73</sup> Modified per CCAP-OSSv3.1-N-15.1307-3 on 6/1/15 by KB; per CCAP-OSSv3.1-N-16.1566-1 on 11/16/16 by KB; per CCAP-OSSv3.1-N-16.1618-3 on 11/17/16 by KB.

For SC-QAM channels, the CCAP MUST implement the docsIfDownChannelWidth value based on the value of docsIf3MdCfgDownChannelAnnex. For SC-QAM channels, the CCAP MUST derive instances of the docsIfDownChannelAnnex from the values of docsIf3MdCfgDownChannelAnnex in a given MAC Domain.

For SC-QAM channels, the CCAP MUST report the value of docsIfDownChannelPower [RFC 4546] within 2 db of the actual power specified in dBmV as specified in [PHYv3.1].

The CCAP SHOULD NOT allow changes to the DS Channel Ids when modems are present on those channels, since any CMs that are already online will re-initialize and/or attempt to use a channel other than the one intended. The CCAP MUST ensure that an upstream or downstream channel ID is unique within a MAC Domain.

As with downstream OFDM channels and the docsIfDownChannelTable, upstream OFDMA channels cannot be represented properly in the docsIfUpChannelTable. Thus, for OFDMA channels, the CCAP MUST report the following (Table 7-7) for OFDMA channel row entries in the docsIfUpChannelTable:

**Table 7-7 - docsIfUpChannelTable Requirements for OFDMA Channels**

MIB Object	Value
docsIfUpChannelFrequency	0
docsIfUpChannelWidth	0
docsIfUpChannelModulationProfile	0
docsIfUpChannelSlotSize	0
docsIfUpChannelTxTimingOffset	0
docsIfUpChannelType	unknown(0)

Other values in the docsIfUpChannelTable for OFDMA channels are reported in an implementation-dependent manner. Operators are advised to not derive meaning from any other column in this table for rows whose columns match the values defined in Table 7-7.

The CCAP MUST report the docsIfCmtsModulationTable for SC-QAM channels. The maximum number of SC-QAM modulation profiles that a CCAP can support in docsIfCmtsModulationTable is vendor-specific. The CCAP MUST NOT include OFDMA Modulation Profiles in the docsIfCmtsModulationTable.

The CCAP MAY provide pre-defined SC-QAM modulation profiles (entries in the DOCS-IF-MIB docsIfCmtsModulationTable) for the purpose of being used by operators directly, or as templates to define other modulation profiles. The pre-defined SC-QAM modulation profiles provided by the CCAP MAY be read-only to prevent users from making accidental modifications. Consequently, adding or creating entries with new docsIfCmtsModIntervalUsageCode values and the same docsIfCmtsModIndex value as a pre-defined modulation profile could result in an error.

The CCAP MUST report the docsIfSignalQualityTable for SC-QAM channels. The CCAP MUST NOT include row entries for OFDMA channels in the docsIfSignalQualityTable.

As of DOCSIS 3.0, the docsIfCmtsCmStatusTable has been deprecated and replaced by the docsIf3CmtsCmRegStatusTable as the docsIfCmtsCmStatusTable doesn't properly support bonded channels.

The CCAP MUST report row entries for SC-QAM channels in the docsIfCmtsChannelUtilizationTable. The CCAP MAY provide row entries for OFDM and/or OFDMA channels in the docsIfCmtsChannelUtilizationTable; however, new utilization tables/objects are defined in the DOCS-IF31-MIB which replace these items for OFDM and OFDMA channels.

The CCAP MUST report row entries for SC-QAM channels in the docsIfCmtsDownChannelCounterTable. The CCAP MAY provide row entries for OFDM channels in the docsIfCmtsDownChannelCounterTable; however, new channel-wide and per profile counters are defined in the DOCS-IF31-MIB which replace these items for OFDM channels.

The CCAP MUST report row entries for SC-QAM channels in the docsIfCmtsUpChannelCounterTable. The CCAP MAY provide row entries for OFDMA channels in the docsIfCmtsUpChannelCounterTable; however, new channel-wide and per profile counters are defined in the DOCS-IF31-MIB which replace these items for OFDMA channels.

The CCAP MUST support the objects in the docsIfCmtsUpChannelCounterTable that are described in the DOCS-IF-MIB as being optional. However, certain impairment events on the upstream channel (e.g., burst noise) could be indistinguishable from collisions, and hence could be counted as such.

The CCAP assigns a unique numeric identifier to each individual CM that is used for per-CM reporting and management purposes. DOCSIS 3.1 defines this identifier as docsIf3CmtsCmRegStatusId. Prior to DOCSIS 3.0 this identifier was docsIfCmtsCmStatusIndex [RFC 4546]. DOCSIS 3.1 CCAP requirements include MIB modules based on docsIfCmtsCmStatusIndex; therefore, the CCAP MUST consider docsIfCmtsCmStatusIndex to be the same identifier as docsIf3CmtsCmRegStatusId for the purpose of CM identification in MIB modules defined through SNMP conceptual row extension, and SNMP conceptual row augmentation. See section "Relation between INDEX and AUGMENTS clauses" of [RFC 2578] for details on these concepts.

The docsIfCmtsSynchInterval object applies to Primary-Capable Downstream interfaces within the MAC Domain.

The docsIfQosProfileTable has been deprecated since the DOCSIS 1.0 Class of Service (CoS) service class definition type was deprecated and is not supported in DOCSIS 3.1.

The object docsIfDocsisBaseCapability is deprecated in DOCSIS 3.1.

#### 7.1.1.5.4 Requirements for SNMPv2 MIB [RFC 3418]

##### 7.1.1.5.4.1 SNMPv2-MIB System Group Requirements

The CMTS and CCAP MUST implement the System Group of [RFC 3418].

The CCAP MUST use the value of the Name attribute of the Ccap object when reporting sysName via the SNMPv2-MIB. The CCAP MUST use the value of the Location attribute of the Ccap configuration object when reporting the sysLocation via the SNMPv2-MIB.

The CMTS and CCAP MUST implement the sysDescr object. For the CMTS and CCAP, the format and content of the information in sysDescr is vendor-dependent.

##### 7.1.1.5.4.2 SNMPv2-MIB SNMP Group Requirements

This group provides SNMP protocol statistics and protocol errors counters.

The CMTS and CCAP MUST implement The SNMP Group from [RFC 3418].

#### 7.1.1.5.5 Requirements for Interfaces Group MIB [RFC 2863]<sup>74</sup>

The CCAP MUST implement the interface MIB [RFC 2863].

The ifType object associated with a DOCSIS interface can have the following enumerated values:

- CATV MAC interface: docsCableMacLayer (127)
- CATV downstream channel: docsCableDownstream (128)
- CATV M-CMTS downstream channel: docsCableMCmtsDownstream (229) (See [M-OSSI])
- CATV Downstream OFDM interface: docsOfdmDownstream (277)
- CATV upstream interface: docsCableUpStream (129)
- CATV Upstream OFDMA interface: docsOfdmaUpstream (278)
- CATV logical upstream channel: docsCableUpstreamChannel (205)
- CATV upstream RF port: docsCableUpstreamRfPort (256)
- CATV downstream RF port: cableDownstreamRfPort (257)

<sup>74</sup> This section, subsections and tables updated per CCAP-OSSv3.1-N-15.1249-3 on 3/6/15 by KB; per CCAP-OSSv3.1-N-16.1667-3 on 12/13/16 by KB.

The following statements define the CCAP interface-numbering scheme requirements:

The CCAP MUST implement an instance of ifEntry for each CATV-MAC interface, downstream channel, upstream interface, logical upstream channel, and any other interface type that exists in the CMTS.

The CCAP MUST populate the ifStackTable with the associations of CATV-MAC interfaces to upstream and downstream channels as defined in the MdChCfg configuration object (refer to Section 7.2.1.1.7).

The CCAP MUST implement a row entry in the ifTable for each Downstream RF Port in the CCAP chassis. A Downstream RF Port is typically associated with a single F-connector or single MCX-75 connector on a DLC.

The CCAP MUST implement an ifType value of 257 in the ifTable row entry for each Downstream RF Port.

When an instance of VideoDownChannel is created on a given Downstream RF Port, the CCAP MUST create an ifTable entry with an ifType value of 214 (mpegTransport). For replicated QAMs, an ifTable entry will be created for every instance of a QAM on a given Downstream RF Port, regardless of whether the QAM has been replicated.

When an instance of DocsisDownChannel is created on a given Downstream RF Port, the CCAP MUST create an ifTable entry with an ifType value of 128 (docsCableDownstream).

When an instance of DOCSIS OFDMDownstreamChannel is created on a given Downstream RF Port, the CCAP MUST create an ifTable entry with an ifType value of 278 (docsOfdmDownstream).

In the absence of user configuration, the CCAP MAY automatically instantiate ifTable entries for VideoDownChannel objects and/or DocsisDownChannel objects.

The CCAP MUST implement a row entry in the ifTable for each Upstream RF Port in the CCAP chassis. An Upstream RF Port is typically associated with a single F-connector or a single MCX-75 connector on a ULC.

The CCAP MUST implement an ifType value of 256 in the ifTable row entry for each Upstream RF Port.

When an instance of DOCSIS UpstreamPhysicalChannel is created on a given Upstream RF Port, the CCAP MUST automatically create one or more corresponding instances of an UpstreamLogicalChannel.

When an instance of DOCSIS UpstreamPhysicalChannel is created on a given Upstream RF Port, the CCAP MUST create an ifTable entry with an ifType value of 129 (docsCableUpstream).

When an instance of DOCSIS OFDMAUpstreamChannel is created on a given Upstream RF Port, the CCAP MUST create an ifTable entry with an ifType value of 278 (docsOfdmaUpstream).

When an instance of DOCSIS UpstreamLogicalChannel is created, the CCAP MUST create an ifTable entry with an ifType value of 205 (docsCableUpstreamChannel).

In the absence of user configuration, the CCAP MAY automatically instantiate DOCSIS UpstreamPhysicalChannels of ifType 129 for each physical Upstream RF port on a ULC.

When an instance of DOCSIS MAC Domain is created, the CCAP MUST create an ifTable entry with an ifType value of 127 (docsCableMaclayer).

For each loopback interface that is defined in the system, the CCAP MUST represent that interface with an ifTable entry with an ifType value of 24, per [RFC 2863].

For each row entry created in the ifTable, the CCAP MUST create a corresponding row entry in the ifXTable.

The CCAP SHOULD maintain the same ifIndex value for configured interfaces across reboots if there have been no configuration changes. The interfaces to be persisted across reboots include those interfaces specified in the CCAP configuration UML object model.

#### 7.1.1.5.5.1 ifAdminStatus

The CCAP MUST NOT accept or forward any traffic over an interface whose ifAdminStatus is 'down', (traffic includes data and MAC management traffic where applicable).

When the CCAP initializes, all Ethernet interfaces start with ifAdminStatus in the up(1) state. As a result of either explicit management or configuration information saved via other non-SNMP method (i.e., CLI commands) retained by the managed system, ifAdminStatus is then changed to either the down(2) or testing(3) states (or remains in the

up(1) state). When the CCAP initializes, all DOCSIS interfaces start with ifAdminStatus in the down(2) state. As a result of either explicit management or configuration information saved via other non-SNMP method (i.e., CLI commands) retained by the managed system, ifAdminStatus is then changed to either the up(1) or testing(3) states (or remains in the down(2) state).

#### 7.1.1.5.5.2 SNMP Notification Control Requirements

If a multi-layer interface model is present in the device, each sub-layer for which there is an entry in the ifTable can generate linkUp/Down traps. Since interface state changes would tend to propagate through the interface stack (from top to bottom, or bottom to top), it is likely that several traps would be generated for each linkUp/Down occurrence. The ifLinkUpDownTrapEnable object allows managers to control SNMP notification generation, and configure only the interface sub-layers of interest.

The CCAP MUST implement the MIB object ifLinkUpDownTrapEnable specified in [RFC 2863].

For linkUp/Down events on CCAP DOCSIS interfaces, the CCAP SHOULD generate an SNMP notification for each CCAP interface. Therefore, the CCAP MUST have its default setting of ifLinkUpDownTrapEnable for each CCAP interface (MAC, RF-Downstream(s), RF-Upstream(s)) set to 'enabled'.

#### 7.1.1.5.5.3 ifTable and ifXTable Counters

Application of the [RFC 2863] ifTable and ifXTable MIB counter objects are done on a per-interface basis and are detailed in Table 7-8. This table defines specific SNMP Access and MIB requirements for each of the interface counters defined in [RFC 2863]. The CCAP MUST count octets on the downstream and upstream interfaces (logical and physical). The CCAP MAY implement the packet counters from [RFC 2863], but when implemented on these interfaces, the counter object will return a value of zero. The CCAP MUST count packets and octets on ethernet and MAC interfaces. Per the requirements in [RFC 2863] Counter Size section, a given interface may support only 32-bit or 64-bit (High Capacity), or both sets of counters based on interface speed.

The following table describes the rules for counting packets and octets on RF and MAC domain interfaces.

**Table 7-8 - IF-MIB Counter Rules<sup>75</sup>**

MIB Counter Objects	MAC Domain Interfaces	Upstream/Downstream RF Interfaces
ifInOctets ifHCInOctets	The total number of data octets (data in transit, data targeted to the managed device) received on this interface from the RF interface and before application of protocol filters.	This includes MAC packets as well as data packets, and includes the length of the MAC header, this does not include any PHY overhead.
ifInUcastPkts ifHCInUcastPkts	The total number of Unicast data packets (data in transit, data targeted to the managed device) received on this interface from the RF interface before application of protocol filters.	The total number of Unicast data packets (data in transit, data targeted to the managed device) received on this interface from the RF interface before application of protocol filters.
ifOutOctets ifHCOutOctets	The total number of data octets (data in transit, data generated by the managed device) transmitted on this interface to the RF interface after application of protocol filters.	This includes MAC packets as well as data packets, and includes the length of the MAC header, this does not include any PHY overhead.
ifOutUcastPkts ifHCOutUcastPkts	The total number of Unicast data packets (data in transit, data generated by the managed device) transmitted on this interface to the RF interface after application of protocol filters.	The total number of Unicast data packets (data in transit, data generated by the managed device) transmitted on this interface after application of protocol filters.
ifInMulticastPkts ifHCInMulticastPkts	The total number of Multicast data packets (data in transit, data targeted to the managed device) received on this interface from the RF interface before application of protocol filters.	The total number of Multicast data packets (data in transit, data targeted to the managed device) received on this interface before application of protocol filters.

<sup>75</sup> Modified per CCAP-OSSv3.1-N-15.1307-3 on 6/1/15 by KB.



MIB Counter Objects	MAC Domain Interfaces	Upstream/Downstream RF Interfaces
ifInBroadcastPkts ifHCInBroadcastPkts	The total number of Broadcast data packets (data in transit, data targeted to the managed device) received on this interface from the RF interface before application of protocol filters.	The total number of Broadcast data packets (data in transit, data targeted to the managed device) received on this interface before application of protocol filters.
ifOutMulticastPkts ifHCOutMulticastPkts	The total number of Multicast data packets (data in transit, data generated by the managed device) transmitted on this interface to the RF interface after application of protocol filters	The total number of Broadcast data packets (data in transit, data targeted to the managed device) received on this interface before application of protocol filters.
ifOutBroadcastPkts ifHCOutBroadcastPkts	The total number of Broadcast data packets (data in transit, data generated by the managed device) transmitted on this interface to the RF interface after application of protocol filters	The total number of Broadcast data packets (data in transit, data generated by the managed device) transmitted on this interface after application of protocol filters

The CCAP MUST implement the ifTable and ifXTable [RFC 2863] Counter32 and Counter64 MIB objects as defined for each interface in Table 7-8.

#### 7.1.1.5.5.4 ifSpeed and ifHighSpeed

For SC-QAM downstream channels (VideoDownChannels and DocsisDownChannels), the ifSpeed is the symbol rate multiplied by the number of bits per symbol. For SC-QAM upstream channels, the ifSpeed is the raw bandwidth in bits per second of this interface, regarding the highest speed modulation profile that is defined. This is the symbol rate multiplied with the number of bits per symbol for this modulation profile.

For OFDM downstream channels, the CCAP MUST calculate the ifSpeed per the following algorithm:

```

numCountedSubcarriers = 0;
totalBitLoading = 0;

for (i = 0; i < numActiveSubcarriers; ++i)
{
    if subcarrier is not PLC and not continuous pilot then
    {
        totalBitLoading += modulationOrder(i); //in bits per symbol
        numCountedSubcarriers += 1
    }
}

averageBitLoading = (totalBitLoading / numCountedSubcarriers)
ifSpeed = numCountedSubcarriers * averageBitLoading * subcarrierSpacingHz *
[numSymPeriods/(numSymPeriods + (cyclicPrefixSamples/204.8))] * (127/128)

```

The number of symbols in a minislot for a given OFDMA channel is a factor of the number of symbols in a frame and the number of subcarriers per minislot. The minislot capacity depends on the minislot bit loading and pilot pattern, which are variable per minislot based on IUC, the minislot location in the frame and the burst profile being used. Another factor is whether a minislot is classified as a body minislot or as an edge minislot.

For the purpose of calculating ifSpeed, the CCAP uses an OFDMA Data IUC with the highest capacity assuming that all minislots are body minislots. The minislot capacity is calculated by multiplying the number of data symbols in a minislot by modulation order (in bits per symbol) and adding to the number of complementary pilot symbols in a minislot multiplied by the complementary data pilot modulation order. The upstream channel capacity is calculated by adding the capacity of all minislots in a frame and multiplying that number by the frame rate.

For upstream OFDMA channels, the CCAP MUST calculate the ifSpeed per the following algorithm:

```

frameCapacity = 0

for (i = 0; i < numMinislotsPerFrame; ++i)
{

```

```

minislotCapacity(i) = numDataSymbols(i) * modulationOrder(i) +
                    numComplementaryPilotSymbols(i) * compPilotSymbolModulationOrder(i);
frameCapacity += minislotCapacity(i);
}

```

```

ifSpeed = numFramesPerSecond * frameCapacity;

```

7.1.1.5.5.5 CCAP ifStack Table

Shown below is an example of how the ifStack table might look for downstream interfaces on the CCAP. The values used for the ifIndexes are for example purposes only. The ifStack table for the CCAP has been modified from previous versions of DOCSIS and CableLabs specifications. The rationale for this change is related to the multiservice nature of the CCAP and the desire to include the physical port in the ifStack. On the downstream side of the ifStack, the table remains consistent with the way Downstream Interfaces were modeled in the DOCSIS and Modular Headend Architectures, with the exception being the addition of the Downstream RF Port being placed at the bottom of the ifStack. The diagram in Figure 7-1 shows both the VideoDownChannel objects and the DocsisDownChannel objects being sent over the same DS RF Port.

On the upstream side, similar constructs have been used; however, the upstream model has inverted the relationship between Upstream Logical and Upstream Physical channels to more accurately reflect the nature of the relationships between burst receivers and the channels they are configured to receive. In the CCAP model, the lowest tier of the ifStack starts with the Upstream RF Port, then moves to the Upstream Physical Channel, and then progresses to the Upstream Logical Channels, and finally the DOCSIS MAC Domain.

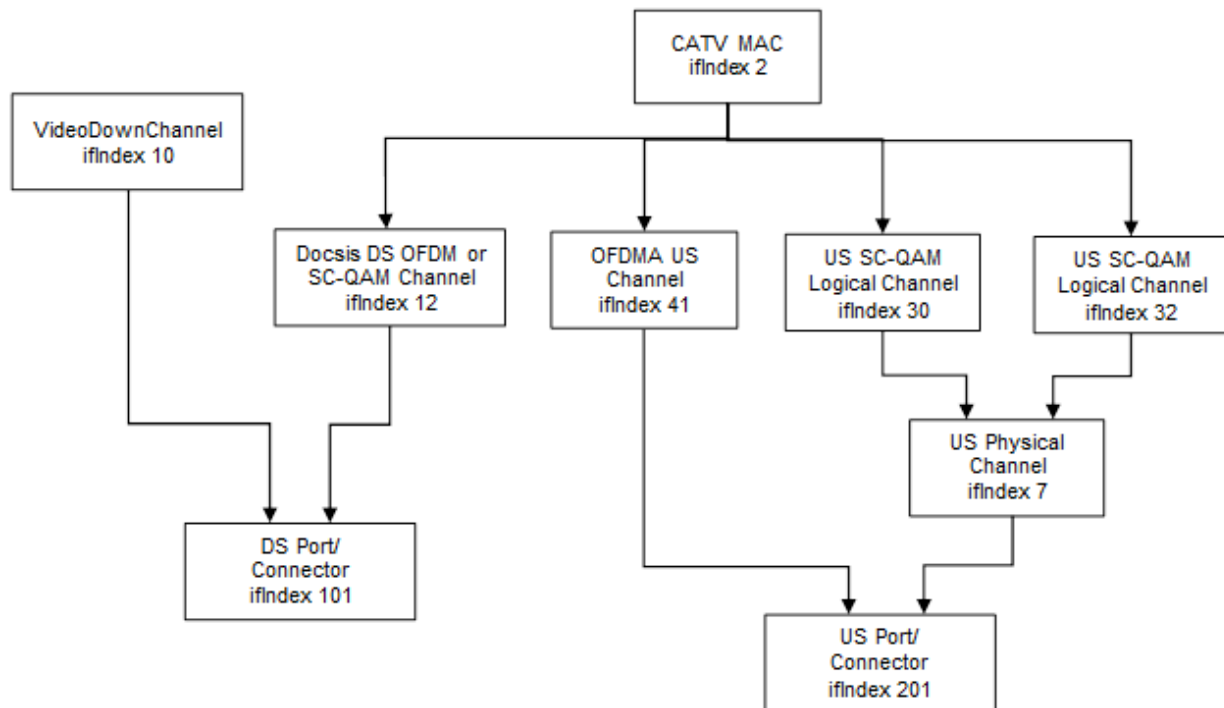

Figure 7-1 - ifStack Table for CCAP RF Interfaces

Table 7-9 - CCAP ifStack Table Representation

ifStackHigherLayer	ifStackLowerLayer
0	2
0	10

ifStackHigherLayer	ifStackLowerLayer
2	12
2	30
2	32
2	41
7	201
10	101
12	101
30	7
32	7
41	201
101	0
201	0

**Table 7-10 - IfTable/IfXTable Details for Ethernet Interfaces**

MIB Objects	CCAP-Ethernet	DTI
<b>IfTable</b>		
ifIndex	(n)	(n)
ifDescr		
ifType	6	other(1)
ifMtu	1500	256
ifSpeed (bps) Note: Interfaces higher than 10Gbps are not shown in this MIB Object. These interface speeds are recorded in the ifXTable ifHighSpeed MIB Object.	100,000 1000,000,000, 10,000,000,000,	5
ifPhysAddress	MAC Address of this interface	Empty-String
ifAdminStatus Refer to Section 7.1.1.5.5.1	up(1), down(2), testing(3)	up(1), down(2), testing(3)
ifOperStatus	up(1), down(2), testing(3), dormant(5), notPresent(6)	up(1), down(2), testing(3), dormant(5), notPresent(6)
ifLastChange		
ifXTable		
ifName		
ifLinkUpDownTrapEnable		
ifHighSpeed (mbits/sec)	100, 1000, 10,000, 40,000, 100,000	5
ifPromiscuousMode	true(1), false(2)	true(1), false(2)
ifConnectorPresent		
ifAlias		
ifCounterDiscontinuityTime		

**Table 7-11 - IfTable/IfXTable for RF and DOCSIS Interfaces<sup>76</sup>**

MIB Objects	CCAP-MAC	CCAP VideoDown Channel	CCAP DocsisDown Channel	CCAP-Upstream Physical Channel	CCAP-Upstream Logical Channel	CCAP DsRfPort	CCAP UsRfPort	CCAP DsOfdm Channel	CCAP UsOfdma Channel
<b>IfTable</b>									
ifIndex	(n)	(n)	(n)	(n)	(n)	(n)	(n)	(n)	(n)
ifDescr									
ifType	127	214*	128	129	205	257	256	277	278
ifMtu	2000	188	2030	2030	2030	0	0	2030	2030
For RF Upstream/Downstream; the value includes the length of the MAC header. Note: When a DOCSIS 3.1 CCAP enables extended MAC frame length for a CM, the CCAP-MAC MTU should reflect a value configured by the CCAP up to a maximum value of 2000. Refer to [MULPIv3.1] Extended MAC Frame Length.									
ifSpeed Refer to Section 7.1.1.5.5.4	0	DVB-C ~QAM64= 41,712,000 ~QAM256= 55,616,000 J.83 Annex B ~QAM64= 30,341,646 ~QAM256= 42,884,296	DVB-C ~QAM64= 41,712,000 ~QAM256= 55,616,000 J.83 Annex B ~QAM64= 30,341,646 ~QAM256= 42,884,296	(n)	(n)	0	0	Refer to Section 7.1.1.5.5.4	Refer to Section 7.1.1.5.5.4
ifPhysAddress	MAC Address of interface	Empty-String	Empty-String	Empty-String	Empty-String	Empty-String	Empty-String	Empty-String	Empty-String
ifAdminStatus:	up(1), down(2), testing(3)	up(1), down(2), testing(3)	up(1), down(2), testing(3)	up(1), down(2), testing(3)	up(1), down(2), testing(3)	up(1), down(2), testing(3)	up(1), down(2), testing(3)	up(1), down(2), testing(3)	up(1), down(2), testing(3)

<sup>76</sup> Modified per CCAP-OSSv3.1-N-16.1563-2 on 11/16/16 by KB.

MIB Objects	CCAP-MAC	CCAP VideoDown Channel	CCAP DocsisDown Channel	CCAP-Upstream Physical Channel	CCAP-Upstream Logical Channel	CCAP DsRfPort	CCAP UsRfPort	CCAP DsOfdm Channel	CCAP UsOfdma Channel
<b>ifTable</b>									
ifOperStatus	up(1), down(2), testing(3), dormant(5), notPresent(6)	up(1), down(2), testing(3), dormant(5), notPresent(6)	up(1), down(2), testing(3), dormant(5), notPresent(6)	up(1), down(2), testing(3), dormant(5), notPresent(6)	up(1), down(2), testing(3), dormant(5), notPresent(6)	up(1), down(2), testing(3), dormant(5), notPresent(6)	up(1), down(2), testing(3), dormant(5), notPresent(6)	up(1), down(2), testing(3), dormant(5), notPresent(6)	up(1), down(2), testing(3), dormant(5), notPresent(6)
ifLastChange									
<b>ifXTable</b>									
ifName									
ifLinkUpDownTrapEnable									
ifHighSpeed Refer to Section 7.1.1.5.5.4	0	DVB-C ~QAM64=41, ~QAM256=55 J.83 Annex B ~QAM64=30, ~QAM256=42	DVB-C ~QAM64=41, ~QAM256=55 J.83 Annex B ~QAM64=30, ~QAM256=42	(n)*	(n)**	0	0	Refer to Section 7.1.1.5.5.4	Refer to Section 7.1.1.5.5.4
ifPromiscuousMode	True(1), False(2)		False(2)	True(1), False(2)	True(1)	False(2)	False(2)	False(2)	False(2)
ifConnectorPresent									
ifAlias									
ifCounterDiscontinuityTime									
Table Note:									
* Also considered 226-QAM, but selected MPEG transport because the interface represents the logical content rather than the physical transmission.									

Table 7-12 - CCAP ifCounters Information<sup>77</sup>

MIB Counter Objects	Access	CCAP-MAC	CCAP-Video Down Channel	CCAP-Docsis Down Channel	CCAP-Upstream Physical Channel	CCAP-Upstream Logical Channel	CCAP-Ds RfPort	CCAP-Us RfPort	CCAP DsOfdm Channel	CCAP UsOfdma Channel
<b>ifTable</b>										
ifInOctets	RO	Mandatory	Mandatory	NA	Mandatory	Mandatory	NA	NA	Mandatory	Mandatory
ifInUcastPkts	RO	Mandatory	NA	NA	Optional	Optional	NA	NA	NA	Mandatory
ifInDiscards	RO	Mandatory	NA	NA	Optional	Optional	NA	NA	NA	Mandatory

<sup>77</sup> Modified per CCAP-OSSiv3.1-N-15.1307-3 on 6/1/15 by KB.

MIB Counter Objects	Access	CCAP-MAC	CCAP-Video Down Channel	CCAP-Docsis Down Channel	CCAP-Upstream Physical Channel	CCAP-Upstream Logical Channel	CCAP-Ds RfPort	CCAP-Us RfPort	CCAP DsOfdm Channel	CCAP UsOfdma Channel
ifInErrors	RO	Mandatory	NA	NA	Optional	Optional	NA	NA	NA	Mandatory
ifInUnknownProtos	RO	Mandatory	NA	NA	Optional	Optional	NA	NA	NA	Optional
ifOutOctets	RO	Mandatory	Mandatory	M	NA	NA	NA	NA	Mandatory	NA
ifOutUcastPkts	RO	Mandatory	NA	O	NA	NA	NA	NA	Mandatory	NA
ifOutDiscards	RO	Mandatory	NA	O	NA	NA	NA	NA	Mandatory	NA
ifOutErrors	RO	Mandatory	NA	O	NA	NA	NA	NA	Mandatory	NA
<b>ifXTable</b>										
ifInMulticastPkts	RO	Mandatory	NA	NA	Optional	Optional	NA	NA	NA	Mandatory
ifInBroadcastPkts	RO	Mandatory	NA	NA	Optional	Optional	NA	NA	NA	Mandatory
ifOutMulticastPkts	RO	Mandatory	NA	O	NA	NA	NA	NA	Mandatory	NA
ifOutBroadcastPkts	RO	Mandatory	NA	O	NA	NA	NA	NA	Mandatory	NA
IfHCInOctets	RO	Mandatory	Mandatory	NA	Mandatory	Mandatory	NA	NA	NA	Mandatory
ifHCInUcastPkts	RO	Mandatory	NA	NA	Optional	Optional	NA	NA	NA	Mandatory
ifHCInMulticastPkts	RO	Mandatory	NA	NA	Optional	Optional	NA	NA	NA	Mandatory
ifHCInBroadcastPkts	RO	Mandatory	NA	NA	Optional	Optional	NA	NA	NA	Mandatory
ifHCOctets	RO	Mandatory	Mandatory	M	NA	NA	NA	NA	Mandatory	NA
ifHCOUcastPkts	RO	Mandatory	NA	O	NA	NA	NA	NA	Mandatory	NA
ifHCOMulticastPkts	RO	Mandatory	NA	O	NA	NA	NA	NA	Mandatory	NA
ifHCOBroadcastPkts	RW	Mandatory	NA	O	NA	NA	NA	NA	Mandatory	NA

#### 7.1.1.5.6 Requirements for Entity-MIB [RFC 4133]<sup>78</sup>

The CCAP MUST implement the ENTITY-MIB [RFC 4133] as described in the following subsections and Annex A.

##### 7.1.1.5.6.1 Entity-MIB CCAP Requirements for entPhysicalTable

The CCAP implements a row entry in the entPhysicalTable for the system chassis and each Field Replaceable Unit (FRU) installed in the CCAP chassis.

The CCAP MUST report an entry in the entPhysicalTable for the chassis component with Physical Class 'chassis'.

The CCAP MUST report entries in the entPhysicalTable of Physical Class 'container' (such as slots) that contains physical Field Removable Units (FRU) normally modeled as elements of Physical Class 'module'.

The CCAP MUST provide as much information as possible about entPhysicalTable listed in Table 7-13 for major components such as CCAP chassis, backplanes and containers or modules in the form of cards and/or field replaceable units (FRUs) when possible. Modules within modules (or cards) or other contained physical components need not be detailed.

The CCAP MUST provide the unique component serial number, via the entPhysicalSerialNum object, contained within the row entry in the entPhysicalTable for the system chassis and each FRU that has a serial number in the system. Example FRUs with serial numbers include, but are not limited to, fabric cards, DTI cards, SREs, DLCs, ULCs, combined Upstream & Downstream line cards, Ethernet cards, and PON line cards.

The CCAP SHOULD provide the unique component serial number, via the entPhysicalSerialNum object, contained within the row entry in the entPhysicalTable for each FRU that is a pluggable optical module such as an SFP, SFP+, QSFP, XFP, CXP.

Example FRUs that might not have serial numbers, yet are expected to be represented in the entPhysicalTable, include flash cards, fan modules, and power supply modules.

The CCAP SHOULD implement row entries in the entPhysicalTable for temperature sensors in the system with an entPhysicalClass value of "sensor".

The CCAP MAY report temperature sensors in the form of instances in the entPhysicalTable for elements of Physical Class 'sensor' with the corresponding entPhySensorType 'celsius' value in the corresponding entPhySensorTable instance of the ENTITY-SENSOR-MIB [RFC 3433].

The CCAP SHOULD provide the unique component serial number, via the entPhysicalSerialNum object, contained within the row entry in the entPhysicalTable for every FRU that is capable of causing and/or generating an event, message, log, or alarm.

The [DRFI] specification defines a multi-channel RF port capability. The set of downstream channels within the same RF port is also known as a "Channel Block" (see [DRFI]).

The [MULPIv3.1] specification does not have a concrete definition of multiple upstream interfaces being part of the same RF spigot as [DRFI] does for downstream channels, but in several diagrams (e.g., [MULPIv3.1] Downstream Convergence Layer Block Diagram) those options are discussed. For the upstream interfaces, only the physical upstream interfaces are modeled in the Entity MIB. The logical upstream interfaces are defined in the CCAP ifStackTable.

A Channel Block is defined as the set of downstream interfaces (Physical Class 'port') that share the same immediate physical component of Physical Class 'module' in the containment tree (entPhysicalContainsTable).

The Entity MIB entries below the 'chassis' container will at a minimum consist of the downstream and upstream interfaces and optionally the logical MAC Domain groupings. The goal in this reporting structure is to catalog and report those interfaces that can be combined to logically form MAC Domains.

---

<sup>78</sup> Modified per CCAP-OSSiv3.1-N-15.1417-1 on 3/16/16 by KB.

The CCAP MUST report RF ports as Physical Class 'module' elements in the entPhysicalTable. The CCAP MUST include the text "RF port" within the description of the SNMP object entPhysicalDescr for RF ports modeled in the entPhysicalTable.

The CCAP MAY report MAC Domain interfaces (ifType = 127) as Physical Class 'module' in the entPhysicalTable.

The CCAP MUST report downstream interfaces (ifType = 128 and ifType = 277), as Physical Class 'port' in the entPhysicalTable.

The CCAP MUST report upstream interfaces (ifType = 129 and ifType = 278) as Physical Class 'port' in the entPhysicalTable. Upstream logical channels are not represented in the entPhysicalTable as those are subinterfaces illustrated in the ifStackTable [RFC 2863].

The CCAP MAY represent interfaces other than the defined above as part of the entPhysicalTable.

7.1.1.5.6.2 CCAP Guidelines for the implementation of the Entity MIB

The Entity MIB [RFC 4133] provides a physical component layer applicable to managed objects defined for DOCSIS devices. In particular for the entPhysicalTable MIB objects, not all the physical components listed need to instantiate all the object's attributes in entPhysicalTable (the Maximum Access is as defined in [RFC 4133]).

Table 7-13 represents high level constraints for any instance of entPhysicalTable.

**Table 7-13 - entPhysicalTable Requirements**

MIB object	Value
entPhysicalIndex	n
entPhysicalDescr	Text Description
entPhysicalVendorType	Enterprise-specific OID or zeroDotZero
entPhysicalContainedIn	0..n
entPhysicalClass	Physical Class per [RFC 4133]
entPhysicalParentRelPos	-1..n per [RFC 4133]
entPhysicalName	Physical element name In case of a component mapped to an interface Index ifName can be reported, otherwise zero-length string
entPhysicalHardwareRev	Hardware revision or zero-length string
entPhysicalFirmwareRev	Firmware revision or zero-length string
entPhysicalSoftwareRev	Software revision or zero-length string
entPhysicalSerialNum	Serial Number or zero-length string
entPhysicalMfgName	Manufacturer Name or zero-length string
entPhysicalModelName	Model Name or zero-length string
entPhysicalAlias	Physical element operator defined alias In case of a component mapped to an interface Index ifAlias can be reported and implemented as read-only, otherwise zero-length string
entPhysicalAssetID	User defined Asset ID or zero-length string
entPhysicalIsFRU	'true' or 'false'
entPhysicalMfgDate	Manufacturer data or all zeros '0000000000000000'H
entPhysicalUris	URI or zero-length string

The following sections detail requirements for the CCAP on specific topics where the DOCSIS 3.1 requirements interact with the Entity MIB have been set.



#### 7.1.1.5.6.3 Entity-MIB CCAP Requirements for entLogicalTable, entLPMappingTable and entConfigChange Notification

The CCAP is not required to support multiple naming scopes. Therefore, this specification has no CCAP requirements for entLogicalTable and entLPMappingTable and is left for vendor-specific implementation.

In addition, this specification has no CCAP requirements for the entConfigChange Notification and is left for vendor-specific implementation.

#### 7.1.1.5.6.4 Entity-MIB CCAP Requirements for entPhysicalContainsTable

The purpose of the entPhysicalContainsTable in the CCAP is to represent the association of multiple downstream and upstream interfaces within the physical construction of the CCAP. These associations are already modeled in the entPhysicalTable (entPhysicalContainedIn and entPhysicalParentRelPos). The entPhysicalContainsTable provide a more direct relationship of those parent-child associations. Additionally it may provide mechanisms to indicate other associations like restrictions and configurability of downstream and upstream interfaces within a particular MAC Domain as defined below.

For the purpose of identifying downstream and upstream interfaces within an RF port as well as Channel Blocks, the CCAP MAY report in the entPhysicalContainsTable the physical component of Physical Class 'module' as the entPhysicalIndex value for each of the downstream or upstream interface Physical Indexes as the values for entPhysicalChildIndex.

For the purpose of modeling which upstream and downstream interfaces can physically and logically be configured within a MAC Domain, the CCAP MAY define logical components of Physical Class 'backplane' (in entPhysicalTable) to include (in entPhysicalContainsTable) all the MAC Domain interface resources and downstream/upstream interfaces that could potentially be added in a particular MAC Domain.

If supported, the CCAP MAY apply the following rules to indicate containment models for MAC Domain and downstream/upstream associations:

- The 'backplane' physical component entries in entPhysicalTable have a valid Physical Index for entPhysicalContainedIn (e.g., the CCAP 'chassis' or another 'backplane' Physical Class component).
- The 'backplane' physical components are not referenced by other physical components in entPhysicalTable as their entPhysicalContainedIn value.
- Physical components 'backplane' are the parent index in entPhysicalContainsTable for children indexes representing MAC Domain interfaces, downstream/upstream interfaces, and/or physical components 'modules' that represent RF ports or Channel Blocks. When this set of parent-child entries contains 'modules' (e.g., Channel Blocks) instead of individual US/DS interfaces, it indicates that the complete 'module' is configurable within a single MAC Domain, while the existence of individual 'backplane' - downstream/upstream interfaces parent-children entries in entPhysicalContainsTable indicates that individual channels (even within a Channel Block) can be associated with specific MAC Domains).

The CCAP does not need to report in the entPhysicalContainsTable the MAC Domain downstream/upstream channel hierarchy normally represented in the ifStackTable.

#### 7.1.1.5.6.5 Entity-MIB CCAP Requirements for entAliasMappingTable

The entAliasMappingTable is used in this specification to associate the physical elements modeled in the Entity MIB with the logical components of the CCAP management model.

For each row entry created in the SNMPv2-MIB ifTable that can be mapped to an entity represented in the Entity-MIB, the CCAP MUST create a corresponding row entry in the entAliasMappingTable.

The CCAP MUST implement a row entry in the entAliasMappingTable for each UsRfPort and each DsRfPort in the chassis.

The CCAP MAY represent the mapping of MAC Domain to downstream and upstream interfaces in the entAliasMappingTable.

The CCAP MAY represent the mapping of other logical components with physical components in the entAliasMappingTable.

#### *7.1.1.5.7 Requirements for Entity Sensor MIB [RFC 3433]*

The CMTS MAY implement the Entity Sensor MIB [RFC 3433].

For ENTITY-MIB [RFC 4113] entPhysicalTable instances with entPhysicalClass of 'sensor', the CMTS and CCAP MAY implement the entPhySensorTable with the same entPhysicalIndex used in the entPhysicalTable and the entPhySensorType of 'celsius'.

#### *7.1.1.5.8 Requirements for Host Resources MIB [RFC 2790]*

The CMTS and CCAP MAY implement the HOST-RESOURCES-MIB [RFC 2790].

#### *7.1.1.5.9 Requirements for Ethernet Interface MIB [RFC 3635]*

The CMTS and CCAP MUST implement [RFC 3635] for each of its Ethernet interfaces.

#### *7.1.1.5.10 Requirements for Bridge MIB [RFC 4188]*

If a CMTS is a Bridging CMTS, the CMTS MUST implement the Bridge MIB [RFC 4188] to manage the bridging process and represent state information about the CMTS Forwarders using link-layer (bridging) semantics.

If STP is enabled for the CMTS, then the CMTS implements the dot1dStp scalar group [RFC 4188] and optionally the dot1dStpPortTable [RFC 4188] as specified in Annex A.

#### *7.1.1.5.11 Requirements for Internet Protocol MIB [RFC 4293]*

The CMTS and CCAP requirements for [RFC 4293] are defined in the following sections.

##### *7.1.1.5.11.1 The IP Group*

The CMTS MUST implement the ipv4GeneralGroup.

The CMTS MUST implement the ipv6GeneralGroup2.

The CMTS MUST implement the ipv4InterfaceTable.

The CMTS MUST populate the ipv4InterfaceTable with each Ethernet interface with an assigned IPv4 address. The CMTS MAY record other interfaces in the ipv4InterfaceTable which have assigned IPv4 addresses.

The CMTS MUST populate the ipv6InterfaceTable with each Ethernet interface with an assigned IPv6 address. The CMTS MAY record other interfaces in the ipv6InterfaceTable which have assigned IPv6 addresses.

The CMTS MAY implement the ipSystemStatsTable.

The Routing CMTS MUST implement the ipIfStatsTable that includes both the CATV MAC interface and any NSI interfaces. The Bridging CMTS MAY implement the ipIfStatsTable.

The Routing CMTS MUST implement the ipAddressPrefixTable. The Bridging CMTS MAY implement the ipAddressPrefixTable.

The Routing CMTS MUST implement the ipAddressTable as Read-Only. The Bridging CMTS MAY implement the ipAddressTable.

The Routing CMTS MUST implement the ipNetToPhysicalTable. The Bridging CMTS MAY implement the ipNetToPhysicalTable.

The Routing CMTS MUST implement the ipDefaultRouterTable. The Bridging CMTS MAY implement the ipDefaultRouterTable.

If the CMTS has been configured for a default route, the Routing CMTS MUST populate the default router in the ipDefaultRouterTable.

The CMTS can populate the ipDefaultRouterTable with an IPv4 and/or IPv6 statically configured default router or a default router learned through a dynamic update mechanism such as a routing protocol update or IPv6 router advertisement message.

The Routing CMTS MUST implement the ipv6RouterAdvertTable. The Bridging CMTS MUST NOT implement the ipv6RouterAdvertTable.

#### 7.1.1.5.11.2 The ICMP Group

The CMTS MUST implement the icmpStatsTable.

The CMTS MUST implement the icmpMsgStatsTable.

#### 7.1.1.5.12 Requirements for User Datagram Protocol (UDP) MIB [RFC 4113]

The CMTS and CCAP SHOULD implement the UDP-MIB [RFC 4113].

#### 7.1.1.5.13 Requirements for Transmission Control Protocol (TCP) MIB [RFC 4022]

The CMTS and CCAP SHOULD implement the TCP group in [RFC 4022].

#### 7.1.1.5.14 Requirements for Multicast Group Membership Discovery (MGMD) MIB [RFC 5519]

The CMTS MUST implement [RFC 5519].

Refer to Section 6.6.8.21 for DOCSIS 3.1 MGMD CMTS and CCAP configuration implementation details.

#### 7.1.1.5.15 Requirements for DOCSIS Baseline Privacy Plus MIB [RFC 4131]

The CMTS MUST implement [RFC 4131].

The CMTS MUST implement the CMTS extensions to [RFC 4131] listed in Section 6.6.6.2.

The CMTS MUST report values for the MIB object docsBpi2CmtsCACertTrust of either 'trusted', 'untrusted', or 'root'. The CMTS MAY persist entries with a docsBpi2CmtsCACertTrust value of 'chained' across reboots. The CMTS MUST be capable of removing entries in the docsBpi2CmtsCACertTable via SNMP by setting the row status to 'destroy'. The CMTS MUST NOT allow new entries to be created for certificates that already exist in the docsBpi2CmtsCACertTable.

The CMTS MUST persist the entries in docsBpi2CmtsProvisionedCmCertTable across reboots. The CMTS MUST be capable of removing entries in docsBpi2CmtsProvisionedCmCertTable via SNMP by setting the row status to 'destroy'. The CMTS MUST NOT allow new entries to be created for certificates that already exist in the docsBpi2CmtsProvisionedCmCertTable.

The CMTS MUST extend the MIB object docsBpi2CmtsAuthBpkmCmCertValid enumerations as follows:

```
docsBpi2CmtsAuthBpkmCmCertValid      OBJECT-TYPE
    SYNTAX      INTEGER {
        unknown (0),
        validCmChained (1),
        validCmTrusted (2),
        invalidCmUntrusted (3),
        invalidCAUntrusted (4),
        invalidCmOther (5),
        invalidCAOther (6),
        invalidCmRevoked(7),
        invalidCARevoked(8)
    }
    MAX-ACCESS      read-only
    STATUS      current
    DESCRIPTION
        "Contains the reason why a CM's certificate is deemed
        valid or invalid.
        Return unknown(0) if the CM is running BPI mode.
        ValidCmChained(1) means the certificate is valid
        because it chains to a valid certificate."
```

```

ValidCmTrusted(2) means the certificate is valid
because it has been provisioned (in the
docsBpi2CmtsProvisionedCmCert table) to be trusted.
InvalidCmUntrusted(3) means the certificate is invalid
because it has been provisioned (in the
docsBpi2CmtsProvisionedCmCert table) to be untrusted.
InvalidCAUntrusted(4) means the certificate is invalid
because it chains to an untrusted certificate.
InvalidCmOther(5) and InvalidCAOther(6) refer to
errors in parsing, validity periods, etc., which are
attributable to the CM certificate or its chain,
respectively; additional information may be found
in docsBpi2AuthRejectErrorString for these types
of errors.
invalidCmRevoked(7) means the certificate is
invalid as it was marked as revoked.
invalidCARevoked(8) means the CA certificate is
invalid as it was marked as revoked.
"
REFERENCE
  "DOCSIS Security Specification CM-SP-SECv3.0-I08-080522,
  Certificate Revocation section."
::= { docsBpi2CmtsAuthEntry 19 }

```

A DOCSIS 3.0 CMTS uses the value of MdifIndex as the ifIndex key in the following tables:

- docsBpi2CmtsBaseTable
- docsBpi2CmtsAuthTable
- docsBpi2CmtsTEKTable
- docsBpi2CmtsIpMulticastMapTable

Entries in the docsBpi2CmtsIpMulticastMapTable are only populated when an authorized joiner for a specific multicast group, which has been configured in the CmtsGrpCfg object for encryption (i.e., a CmtsGrpEncrypt object instance exists and is referenced by a CmtsGrpCfg instance), has successfully joined a session. Thus entries in this table are only created when active sessions have been initiated to authorized clients.

#### 7.1.1.5.16 Requirements for Diffie-Helman USM Key MIB [RFC 2786]

The CMTS and CCAP MAY implement [RFC 2786].

#### 7.1.1.5.17 Requirements for SNMPv3 MIB Modules<sup>79</sup>

If the CMTS or CCAP supports the SNMPv3 protocol, the CMTS and CCAP MUST implement the MIBs defined in [RFC 3411] through [RFC 3415] and [RFC 3584].

The CMTS and CCAP SHOULD support a minimum of 30 available rows in the vacmViewTreeFamilyTable object.

#### 7.1.1.5.18 Requirements for DOCSIS Interface Extension 2 MIB(Annex A)

The CMTS and CCAP MUST implement DOCS-IFEXT2-MIB, as specified in Annex A.

#### 7.1.1.5.19 Requirements for CableLabs Topology MIB (Annex A)

The CMTS and CCAP MUST implement CLAB-TOPO-MIB, as specified in Annex A.

#### 7.1.1.5.20 Requirements for DOCSIS Diagnostic Log MIB (Annex A)

The CMTS and CCAP MUST implement DOCS-DIAG-MIB, as specified in Annex A.

<sup>79</sup> Modified per CCAP-OSSv3.1-N-15.1307-3 on 6/1/15 by KB.

#### 7.1.1.5.21 Requirements for DOCSIS Interface 3 MIB (Annex A)

The CMTS and CCAP MUST implement the DOCS-IF3-MIB, as specified in Annex A.

#### 7.1.1.5.22 Requirements for DOCSIS Multicast MIB (Annex A)

The CMTS and CCAP MUST implement the DOCS-MCAST-MIB, as specified in Annex A.

#### 7.1.1.5.23 Requirements for DOCSIS Multicast Authorization MIB (Annex A)

The CMTS and CCAP MUST implement the DOCS-MCAST-AUTH-MIB, as specified in Annex A.

#### 7.1.1.5.24 Requirements for DOCSIS Quality of Service 3 MIB (Annex A)

The CMTS and CCAP MUST implement the DOCS-QOS3-MIB, as specified in Annex A.

A DOCSIS 3.1 CMTS and CCAP populates entries in the docsQosUpstreamStatsTable with information for Pre-3.0 DOCSIS devices. Devices operating in Multiple Transmit Channel mode will not be recorded in the docsQosUpstreamStatsTable and will instead be recorded in the docsQosServiceFlowCcfStatsTable.

#### 7.1.1.5.25 Requirements for DOCSIS Security MIB (Annex A)

The CMTS and CCAP MUST implement the DOCS-SEC-MIB, as specified in Annex A.

#### 7.1.1.5.26 Requirements for DOCSIS Subscriber Management 3 MIB (Annex A)

The CMTS and CCAP MUST implement the DOCS-SUBMGT3-MIB, as specified in Annex A.

#### 7.1.1.5.27 Requirements for DOCSIS Load Balancing 3 MIB (Annex A)

The CMTS and CCAP MUST implement the DOCS-LOADBAL3-MIB, as specified in Annex A.

#### 7.1.1.5.28 Requirements for DOCSIS DRF MIB [DRFI]

The CMTS MUST implement the managed objects from DOCS-DRF-MIB [DRFI] specified in Annex A for all the Downstream Channel interfaces that are integrated (ifType = 'docsCableDownstream').

#### 7.1.1.5.29 Requirements for IP Multicast MIB [RFC 5132]<sup>80</sup>

The CCAP MUST implement [RFC 5132].

If the CCAP has any one of the following multicast protocols enabled, PIM [RFC 4601], MLD [RFC 2710] [RFC 3810], or IGMP [RFC 1112] [RFC 2236] [RFC 3376], the CCAP MUST report a value of 'true' for ipMcastEnabled. When all three multicast protocols, PIM, MLD and IGMP are disabled in the CCAP, the value of 'false' is reported for ipMcastEnabled.

## 7.2 Performance Management UML Object Models

The Performance Management UML model has been divided into the following categories:

- State Data: These object are used to gather state information from the CCAP.
- Statistical Data: These objects are used to gather statistical information from the CCAP.

Those models are shown in the following sections.

### 7.2.1 State Data Objects

#### 7.2.1.1 CMTS Bonding

---

<sup>80</sup> Added per CCAP-OSSiv3.1-N-15.1307-3 on 6/1/15 by KB.

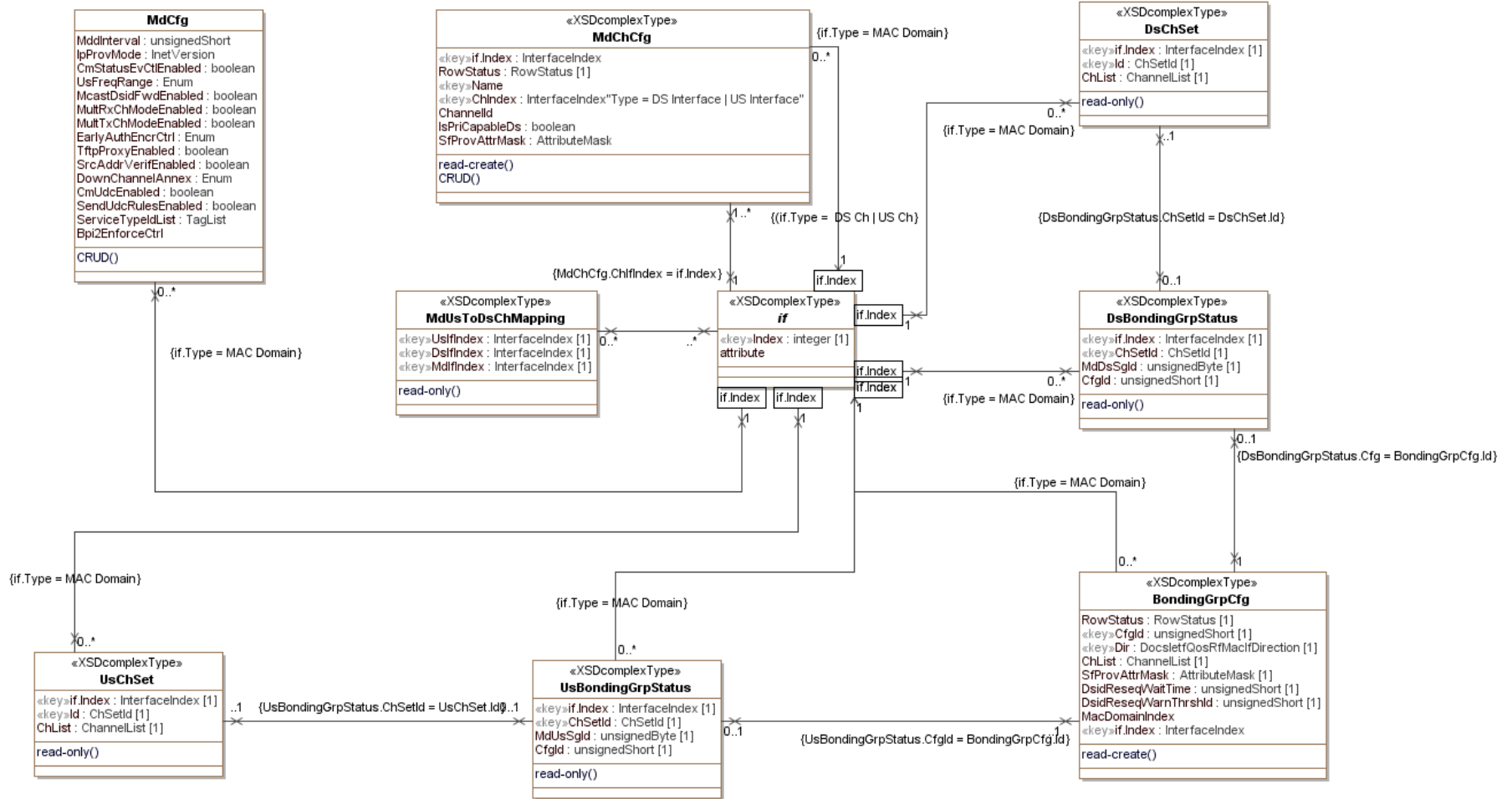

Figure 7-2 - CMTS Bonding Performance Management Objects

### 7.2.1.1.1 MdUsToDsChMapping

This object returns the set of downstream channels that carry UCDs and MAPs for a particular upstream channel in a MAC Domain.

**Table 7-14 - MdUsToDsChMapping Object**

Attribute Name	Type	Access	Type Constraints	Units	Default
UsIfIndex	InterfaceIndex	key	Interface Index of a logical upstream channel	N/A	N/A
DsIfIndex	InterfaceIndex	key		N/A	N/A
MdIfIndex	InterfaceIndex	read-only		N/A	N/A

#### 7.2.1.1.1.1 UsIfIndex

This key represents the interface index of the logical upstream channel (ifType docsCableUpstreamChannel(205)) to which this instance applies.

#### 7.2.1.1.1.2 DsIfIndex

This key represents the interface index of a downstream channel (ifTypes docsCableDownstream(128) and docsCableMCmtsDownstream(229)) carrying in UCD and MAP messages associated with the upstream channel defined by this instance.

#### 7.2.1.1.1.3 MdIfIndex

This attribute represents the MAC domain of the upstream and downstream channels of this instance.

### 7.2.1.1.2 DsChSet

This object defines a set of downstream channels. These channel sets may be associated with channel bonding groups, MD-DS-SGs, MD-CM-SGs, or any other channel set that the CMTS may derive from other CMTS processes.

References: [MULPIv3.1] Partial Service Encoding section and Cable Modem Attribute Masks section in the Common Radio Frequency Interface Encodings Annex.

**Table 7-15 - DsChSet Object**

Attribute Name	Type	Access	Type Constraints	Units	Default
IfIndex	InterfaceIndex	key	InterfaceIndex of the MAC Domain interface	N/A	N/A
Id	ChSetId	key		N/A	N/A
ChList	ChannelList	read-only	SIZE (0 2..255)	N/A	N/A

#### 7.2.1.1.2.1 IfIndex

This key represents the MAC Domain interface index where the downstream channel set is defined.

#### 7.2.1.1.2.2 Id

This key defines a reference identifier for the downstream channel set within the MAC Domain.

#### 7.2.1.1.2.3 ChList

This attribute defines the ordered list of channels that comprise the upstream channel set.

7.2.1.1.3 *UsChSet*

This object defines a set of upstream channels. These channel sets may be associated with channel bonding groups, MD-US-SGs, MD-CM-SGs, or any other channel set that the CMTS may derive from other CMTS processes.

References: [MULPIv3.1] Partial Service Encoding section and Cable Modem Attribute Masks section in the Common Radio Frequency Interface Encodings Annex.

**Table 7-16 - UsChSet Object**

Attribute Name	Type	Access	Type Constraints	Units	Default
IfIndex	InterfaceIndex	key	InterfaceIndex of the MAC Domain interface	N/A	N/A
Id	ChSetId	key		N/A	N/A
ChList	ChannelList	read-only	SIZE (0 2..255)	N/A	N/A

7.2.1.1.3.1 IfIndex

This key represents the MAC Domain interface index where the upstream channel set is defined.

7.2.1.1.3.2 Id

This key defines a reference identifier for the upstream channel set within the MAC Domain.

7.2.1.1.3.3 ChList

This attribute defines the ordered list of channels that comprise the upstream channel set.

7.2.1.1.4 *DsBondingGrpStatus*

This object returns administratively-configured and CMTS defined downstream bonding groups.

**Table 7-17 - DsBondingGrpStatus Object**

Attribute Name	Type	Access	Type Constraints	Units
IfIndex	InterfaceIndex	key	InterfaceIndex of MAC Domain interface	N/A
ChSetId	ChSetId	key		N/A
MdDsSgId	unsignedByte	read-only		N/A
CfgId	unsignedShort	read-only		N/A

7.2.1.1.4.1 IfIndex

This key represents the interface index of the MAC Domain of the bonding group of this instance.

7.2.1.1.4.2 ChSetId

This key represents the identifier for the Downstream Bonding Group or the single-downstream channel of this instance.

7.2.1.1.4.3 MdDsSgId

This attribute corresponds to the MD-DS-SG-ID that includes all the downstream channels of the Downstream Bonding Group. The value zero indicates that the bonding group does not contain channels from a single MD-DS-SG and therefore the bonding group is not valid and usable.

7.2.1.1.4.4 CfgId

This attribute provides the BondingGrpCfgId for the downstream bonding group if it was configured. Otherwise, the zero value indicates that the CMTS will define the bonding group.



### 7.2.1.1.5 *UsBondingGrpStatus*

This object returns administratively-configured and CMTS-defined upstream bonding groups.

**Table 7-18 - UsBondingGrpStatus Object**

Attribute Name	Type	Access	Type Constraints	Units
ifIndex	InterfaceIndex	key	InterfaceIndex of MAC Domain interface	N/A
ChSetId	ChSetId	key		N/A
MdUsSgld	unsignedByte	read-only		N/A
CfgId	unsignedShort	read-only		N/A

#### 7.2.1.1.5.1 IfIndex

This key represents the interface index of the MAC Domain of the bonding group of this instance.

#### 7.2.1.1.5.2 ChSetId

This key represents the identifier for the Upstream Bonding Group or the single-upstream channel of this instance.

#### 7.2.1.1.5.3 MdUsSgld

This attribute corresponds to the MD-US-SG-ID that includes all the upstream channels of the Upstream Bonding Group. The value zero indicates that the bonding group does not contain channels from a single MD-US-SG and therefore the bonding group is not valid and usable.

#### 7.2.1.1.5.4 CfgId

This attribute provides the BondingGrpCfgId for the upstream bonding group if it was configured. Otherwise, the zero value indicates that the CMTS defines the bonding group.

### 7.2.1.1.6 *BondingGrpCfg*

This object defines statically configured Downstream Bonding Groups and Upstream Bonding Groups on the CMTS.

This object supports the creation and deletion of multiple instances.

Creation of a new instance of this object requires the ChList attribute to be set.

The CMTS MUST persist all instances of BondingGrpCfg across reinitializations.

**Table 7-19 - BondingGrpCfg Object**

Attribute Name	Type	Access	Type Constraints	Units	Default
IfIndex	InterfaceIndex	key	InterfaceIndex of Mac Domain interface	N/A	N/A
Dir	IfDirection	key		N/A	N/A
Id	unsignedShort	key	1..65535	N/A	N/A
ChList	ChannelList	read-create	SIZE (2..255)	N/A	N/A
SfProvAttrMask	AttributeMask	read-create		N/A	'80000000'H
DsidReseqWaitTime	unsignedByte	read-create	0   1..180   255	hundredMicroseconds	255
DsidReseqWarnThrshld	unsignedByte	read-create	0..179   255	hundredMicroseconds	255

#### 7.2.1.1.6.1 IfIndex

This key represents the interface index of the MAC Domain to which this instance applies.

#### 7.2.1.1.6.2 Dir

This key represents whether this bonding group is an Upstream Bonding Group or a Downstream Bonding Group.

#### 7.2.1.1.6.3 CfgId

This key represents the configured bonding group identifier in the indicated direction for the MAC Domain. This attribute is used for the sole purpose of tracking bonding groups defined by management systems.

#### 7.2.1.1.6.4 ChList

This attribute contains the list of channels of the bonding group.

#### 7.2.1.1.6.5 SfProvAttrMask

This attribute represents the Provisioned Attribute Mask encoding for the bonding group.

References: [MULPIv3.1] Service Flow Assignment section.

#### 7.2.1.1.6.6 DsidReseqWaitTime

For a Downstream Bonding Group, this attribute provides the DSID Resequencing Wait Time that is to be used for all DSIDs associated with this Downstream Bonding Group. The value of 255 indicates that the DSID Resequencing Wait Time is determined by the CMTS. The value zero is not supported for downstream bonding groups.

For an Upstream Bonding Group, this attribute has no meaning and returns the value 0.

#### 7.2.1.1.6.7 DsidReseqWarnThrshld

For a Downstream Bonding Group, this attribute provides the DSID Resequencing Warning Threshold that is to be used for all DSIDs associated with this Downstream Bonding Group. The value of 255 indicates that the DSID Resequencing Warning Threshold is determined by the CMTS. The value of 0 indicates that the threshold warnings are disabled. When the value of DsidReseqWaitTime is not equal to 0 or 255, the CMTS MUST ensure that the value of this object is either 255 or less than the value of DsidReseqWaitTime.

For an Upstream Bonding Group, this attribute has no meaning and returns the value 0.

#### 7.2.1.1.7 MdChCfg

This object configures the association of downstream and upstream channels to a particular MAC Domain (MD) on a CMTS. The creation of channels and MAC domain object interface instances is vendor-specific. In particular, the assignment of the channel interface index is normally vendor-specific. Therefore, this object is intended only for associating channels to a MAC Domain and assumes that those channels were previously configured.

The CMTS MAY have restrictions on which channels can be configured in the same MAC Domain. For example, it could require the upstream channels to be from the same line card.

This object supports the creation and deletion of multiple instances.

Creation of a new instance of this object requires the ChId attribute to be set.

The CMTS MUST persist all instances of MdChCfg across reinitializations.

**Table 7-20 - MdChCfg Object**

Attribute Name	Type	Access	Type Constraints	Units	Default
IfIndex	InterfaceIndex	key	InterfaceIndex of MAC Domain interface	N/A	N/A
ChIfIndex	InterfaceIndex	key	InterfaceIndex of downstream or upstream channel	N/A	N/A
IsPriCapableDs	boolean	read-create		N/A	
ChId	ChId	read-create	1..255	N/A	N/A
SfProvAttrMask	AttributeMask	read-create		N/A	'00000000'H

#### 7.2.1.1.7.1 IfIndex

This key represents the interface index of the MAC Domain to which this instance applies. The CMTS MAY restrict the value chosen for the IfIndex attribute of the MdChCfg object.

#### 7.2.1.1.7.2 ChIfIndex

This key represents the interface index of an existing OFDMA upstream (ifType docsOfdmaUpstreamChannel(278)) or OFDM downstream (ifType docsOfdmDownstreamChannel(277)) or existing logical upstream (ifType docsCableUpstreamChannel(205)) or downstream (ifTypes docsCableDownstream(128) and docsCableMCmtsDownstream(229)) channel that is configured to be part of the MAC Domain.

The CMTS could require that all upstream logical channels under the same physical upstream interface be assigned to one MAC Domain.

#### 7.2.1.1.7.3 IsPriCapableDs

If set to 'true', this attribute configures the downstream channel as Primary-Capable. The default value for a downstream channel is 'true'. This attribute is not relevant for upstream interfaces, therefore it reports the value 'false' for such interfaces. A CMTS MAY restrict the permitted value of this attribute based upon physical channel capabilities. OFDM channels are all Primary-Capable.

#### 7.2.1.1.7.4 ChId

This attribute contains the 8-bit Downstream Channel ID (DCID) or Upstream Channel ID (UCID) configured for the channel in the MAC Domain.

#### 7.2.1.1.7.5 SfProvAttrMask

This attribute contains Provisioned Attribute Mask of non-bonded service flow assignment to this channel.

### 7.2.1.2 RxCh Objects<sup>81</sup>

This section defines the CCAP Receive Channel Configuration (RCC) Status objects.

The RccCfg object is taken from the CCAP Configuration UML model, described in Section 6.6.6.6.14, RccCfg.

---

<sup>81</sup> Modified per CCAP-OSSiv3.1-N-15.1259-1 on 3/6/15 by KB; per CCAP-OSSiv3.1-N-16.1684-2 on 12/13/16 by KB.

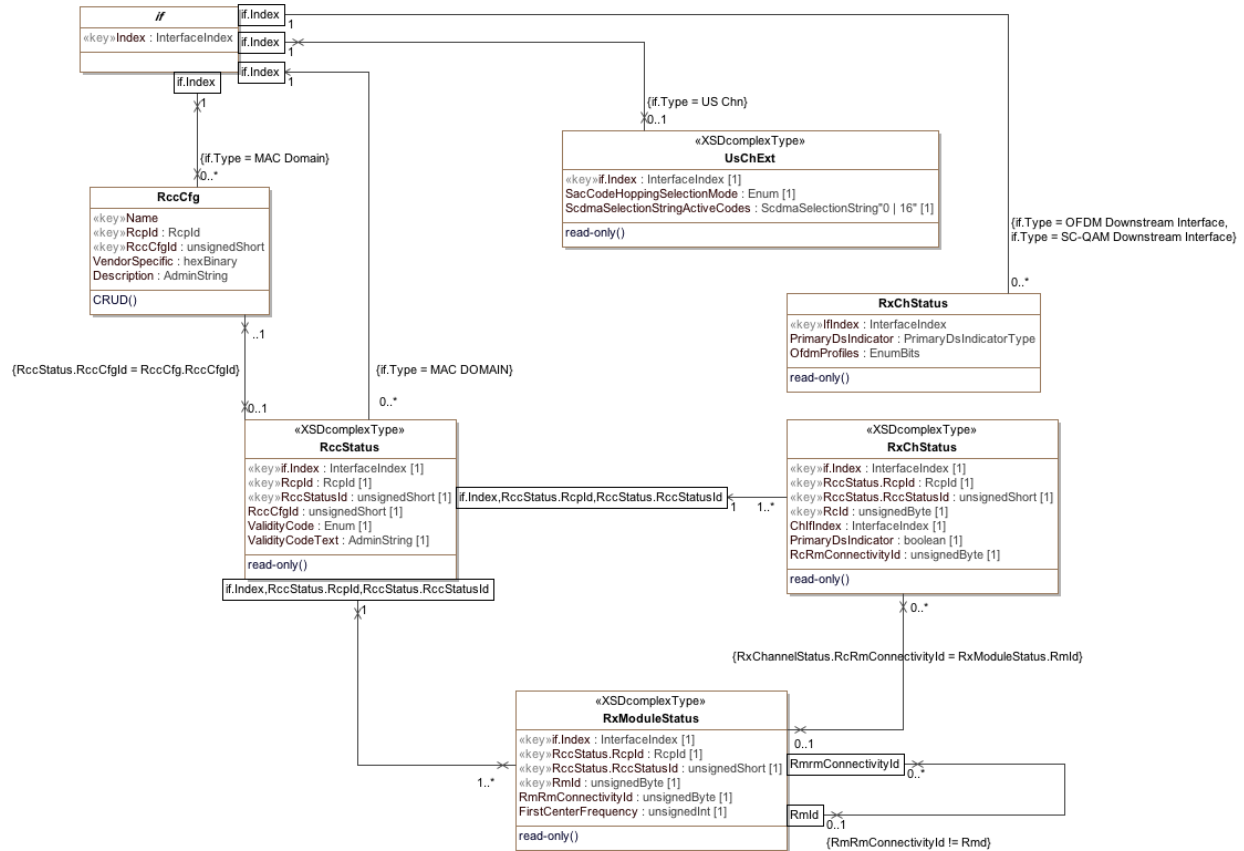

Figure 7-3 - RxCh Performance Management Objects<sup>82</sup>

7.2.1.2.1 RccStatus

The RCC Status object provides a read-only view of the statically-configured (from the RccCfg object) and dynamically-created RCCs.

The CMTS creates an RCC Status instance for each unique MAC Domain Cable Modem Service Group (MD-CM-SG) to which it signals an RCC to the CM.

Table 7-21 - RccStatus Object

Attribute Name	Type	Access	Type Constraints	Units
ifIndex	InterfaceIndex	key	InterfaceIndex of MAC Domain interface	
Rcpld	Rcpld	key		
RccStatusId	unsignedInt	key	1..4294967295	
RccCfgId	unsignedByte	read-only		
ValidityCode	Enum	read-only	other(1) valid(2) invalid(3) wrongPrimaryDs(4) missingPrimaryDs(5) multiplePrimaryDs(6) duplicateDs(7) wrongFrequencyRange(8) wrongConnectivity(9)	

<sup>82</sup> Modified per CCAP-OSSv3.1-N-16.1684-2 on 12/13/16 by KB.

Attribute Name	Type	Access	Type Constraints	Units
ValidityCodeText	AdminString	read-only		

#### 7.2.1.2.1.1 IfIndex

This key represents the interface index of the MAC Domain to which this instance applies.

#### 7.2.1.2.1.2 Rcpld

This key represents the RCP-ID to which this instance applies.

#### 7.2.1.2.1.3 RccStatusId

This key represents an RCC combination for a particular Rcpld either from an RCC configuration object or a CMTS-determined RCC and is unique per combination of MAC Domain IfIndex and Rcpld.

#### 7.2.1.2.1.4 RccCfgId

This attribute identifies an RCC-Configured combination from which this instance was defined. If nonzero, it corresponds to the RccCfg instance from which the RCC was created. Zero means that the RCC was dynamically created by the CMTS.

#### 7.2.1.2.1.5 ValidityCode

This attribute indicates whether the RCC instance of this object is valid or not. An RCC Status instance from a configured or a dynamic RCC could become invalid, for example, due to changes in the topology.

#### 7.2.1.2.1.6 ValidityCodeText

This attribute contains the CMTS vendor-specific log information from the Receive Channel Configuration Status encoding.

### 7.2.1.2.2 RxModuleStatus Object

The Receive Module Status object provides a read-only view of the statically configured and dynamically created Receive Modules within an RCC. When this object is defined on the CM, the value of RccStatusId is always 1.

**Table 7-22 - RxModuleStatus Object**

Attribute Name	Type	Access	Type Constraints	Units
IfIndex	InterfaceIndex	key	InterfaceIndex of MAC Domain interface	
Rcpld	Rcpld	key		
RccStatusId	unsignedByte	key	1..255	
RmId	unsignedByte	key	1..255	
RmRmConnectivityId	unsignedByte	read-only		
FirstCenterFrequency	unsignedInt	read-only		Hz

#### 7.2.1.2.2.1 IfIndex

This key represents the interface index of the MAC Domain to which this instance applies.

#### 7.2.1.2.2.2 Rcpld

This key represents the RCP-ID to which this instance applies.

7.2.1.2.2.3 RccStatusId

This key represents an RCC combination for a particular RcpId either from an RCC configuration object or a CMTS determined RCC and is unique per combination of MAC Domain interface index and RcpId. Note that when this attribute is instantiated at the CM, its value will always be 1.

7.2.1.2.2.4 RmId

This key represents an identifier of a Receive Module instance within the Receive Channel Profile.

References: [MULPIv3.1] Receive Module Index section in the Common Radio Frequency Interface Encodings Annex.

7.2.1.2.2.5 RmRmConnectivityId

This attribute represents the Receive Module to which this Receive Module connects. Requirements for module connectivity are detailed in the RmRmConnectivityId of the RccCfg object.

7.2.1.2.2.6 FirstCenterFrequency

This attribute represents the low frequency channel of the Receive Module, or 0 if not applicable to the Receive Module.

7.2.1.2.3 Pre-DOCSIS 3.1 RxChStatus Object

The Receive Channel Status object reports the status of the statically-configured and dynamically-created Receive Channels within an RCC. When this object is defined on the CM, the value of RccStatusId is always 1.

**Table 7-23 - RxChStatus Object**

Attribute Name	Type	Access	Type Constraints	Units
IfIndex	InterfaceIndex	key	InterfaceIndex of MAC Domain interface	
RcpId	RcpId	key		
RccStatusId	UnsignedByte	key	1..255	
RcId	UnsignedByte	key	1..255	
ChIfIndex	InterfaceIndex	read-only	InterfaceIndex of Downstream Channel assigned to the Receive Channel	
PrimaryDsIndicator	Boolean	read-only		
RcRmConnectivityId	UnsignedByte	read-only		

7.2.1.2.3.1 IfIndex

This key represents the interface index of the MAC Domain to which this instance applies.

7.2.1.2.3.2 RcpId

This key represents the RCP-ID to which this instance applies.

7.2.1.2.3.3 RccStatusId

This key represents an RCC combination for a particular RcpId either from an RCC configuration object or a CMTS determined RCC. It is unique per combination of MAC Domain interface index and RcpId. Note that when this attribute is instantiated at the CM, its value will always be 1.

7.2.1.2.3.4 RcId

This key represents an identifier for the parameters of the Receive Channel instance within the Receive Channel Profile.

#### 7.2.1.2.3.5 ChIfIndex

This attribute contains the interface index of the Downstream Channel that this Receive Channel Instance defines.

#### 7.2.1.2.3.6 PrimaryDsIndicator

If set to 'true', this attribute indicates the Receive Channel is to be the primary-capable downstream channel for the CM receiving this RCC. Otherwise, the downstream channel is to be a non-primary-capable channel.

#### 7.2.1.2.3.7 RcRmConnectivityId

This attribute identifies the Receive Module to which this Receive Channel connects. A value of zero indicates that the Receive Channel Connectivity TLV is omitted from the RCC.

#### 7.2.1.2.4 RxChStatus Object<sup>83</sup>

The Receive Channel Status object reports the status of the statically-configured and dynamically-created Receive Channels within an RCC.

**Table 7-24 - RxChStatus Object**

Attribute Name	Type	Access	Type Constraints	Units	Default
IfIndex	InterfaceIndex	Key	SC-QAM or OFDM Index		
PrimaryDsIndicator	Rcpld	R/O			
OfdmProfiles	EnumBits	R/O			

##### 7.2.1.2.4.1 IfIndex

This key represents the SC-QAM or OFDM interface index to which this instance applies.

##### 7.2.1.2.4.2 PrimaryDsIndicator

This attribute encodes the type of downstream channel.

##### 7.2.1.2.4.3 OfdmProfiles

This attribute identifies the downstream channel profiles provisioned on the CM. Examples of EnumBits follow.

Example 1: A Cable Modem configured with OFDM Profile 5 would return a query response as follows.  
EnumBits: 0000010000000000 or 0x0400.

Example 2: A Cable Modem configured with an SC\_QAM Channel would return a query response as follows.  
EnumBits: 0000000000000000 or 0x0.

##### 7.2.1.2.5 UsChExt

This object defines management extensions for upstream channels, in particular SCDMA parameters.

**Table 7-25 - UsChExt Object Attributes**

Attribute Name	Type	Access	Type Constraints	Units	Default
IfIndex	InterfaceIndex	key	InterfaceIndex of MAC Domain interface	N/A	N/A
SacCodeHoppingSelectionMode	Enum	read-only	none(0) sac1NoCodeHopping(1) sac1CodeHoppingMode1(2) sac2CodeHoppingMode2(3) sac2NoCodeHopping(4)	N/A	N/A

<sup>83</sup> Added per CCAP-OSSiv3.1-N-16.1684-2 on 12/13/16 by KB.

Attribute Name	Type	Access	Type Constraints	Units	Default
ScdmaSelectionStringActiveCodes	HexBinary	read-only	SIZE (0   16)	N/A	N/A

#### 7.2.1.2.5.1 UsChExt Object Attributes

##### 7.2.1.2.5.1.1 IfIndex

This key represents the interface index of the logical upstream channel to which this instance applies.

##### 7.2.1.2.5.1.2 SacCodeHoppingSelectionMode

This attribute indicates the selection mode for active codes and code hopping.

- 'none'  
Non-SCDMA channel
- 'sac1NoCodeHopping'  
Selectable active codes mode 1 and code hopping disabled
- 'sac1CodeHoppingMode1'  
Selectable active codes mode 1 and code hopping mode 1
- 'sac2CodeHoppingMode2'  
Selectable active codes mode 2 and code hopping mode 2
- 'sac2NoCodeHopping'  
Selectable active codes mode 2 and code hopping disabled

References: [PHYv3.1] Minislot Numbering Parameters in UCD section.

##### 7.2.1.2.5.1.3 ScdmaSelectionStringActiveCodes

This attribute represents the active codes of the upstream channel and it is applicable only when SacCodeHoppingSelectionMode is 'sac2CodeHoppingMode2'.

It is a 128-bit string indicating which codes are active. The first element in the string corresponds to code 0 (the all-ones code), and the last element in the string corresponds to code 127. A '1' in the string indicates an active code, and a '0' indicates an unused code. A zero-length string is returned for an unknown or non-applicable value.

References: [PHYv3.1] Minislot Numbering Parameters in UCD section



**7.2.1.3 DOCS-L2VPN-MIB State Objects**

The objects in the DOCS-L2VPN-MIB: State Objects are taken from the DOCS-L2VPN-MIB specified in Annex A of [L2VPN] and are used without modification for the CCAP.

Reference: [L2VPN], DOCS-L2VPN-MIB

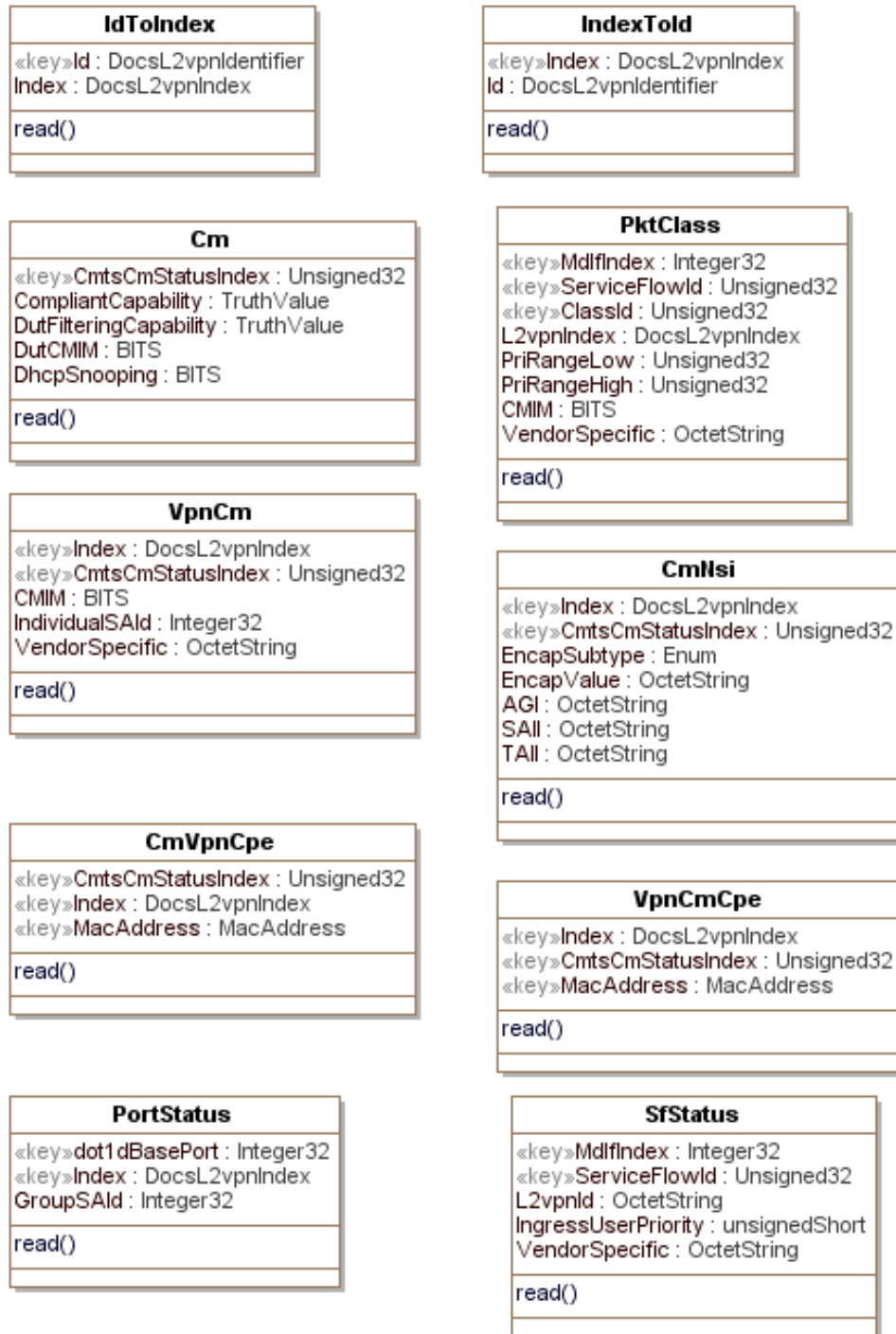

Figure 7-4 - DOCS-L2VPN-MIB: State Objects

**7.2.1.4 DOCS-LOADBAL3-MIB: State Objects**

The objects in the DOCS-LOADBAL3-MIB are taken from the DOCS-LOADBAL3-MIB specified Annex Q of [OSSv3.0] and used without modification for the CCAP.

The following attributes of the CmtsCmParams object are writeable:

- ProvGrpId
- ProvServiceTypeId
- PolicyId
- Priority

Reference: [OSSv3.0], DOCS-LOADBAL3-MIB

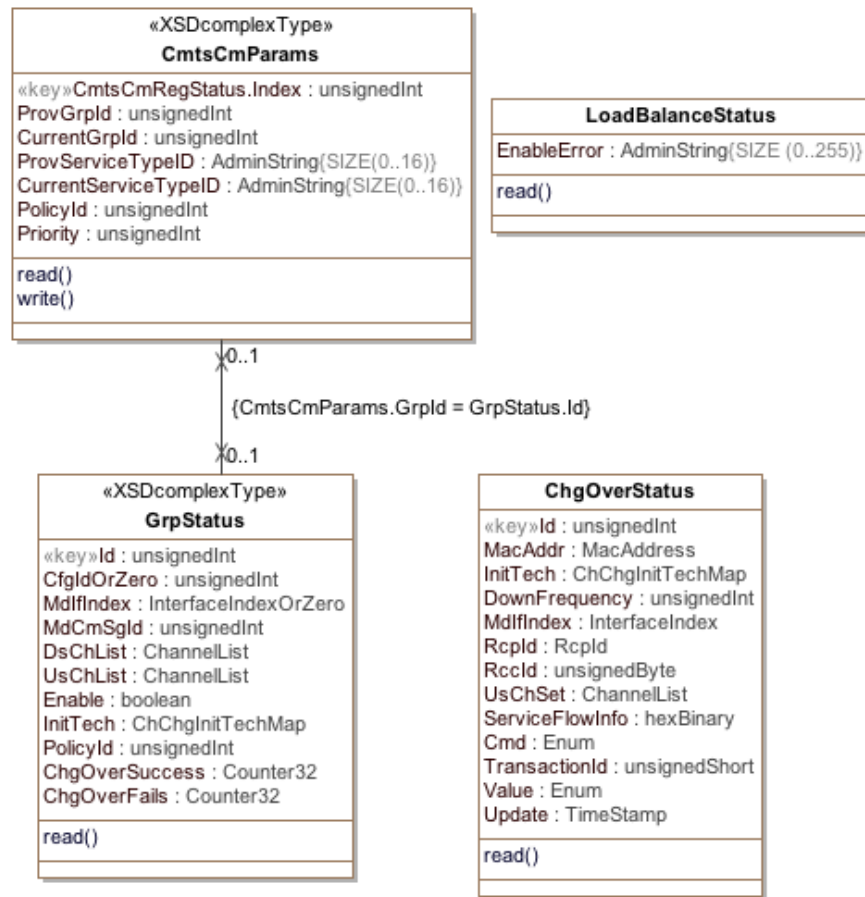

**Figure 7-5 - DOCSIS Load Balance Status Information Model<sup>84</sup>**

**7.2.1.4.1 CmtsCmParams**

This object represents the autonomous load balancing parameters provisioned for cable modem. The CMTS selects the cable modem Load Balancing Group (GrpId attribute of this object) from multiple sources by following the rules and sequence described below:

<sup>84</sup> Modified per CCAP-OSSv3.1-N-1433-1 on 5/13/16 by KB.

The CMTS selects the assignment of the CM to a Load Balancing Group by determining first if the CM is in a Restricted Load Balancing Group or in its absence to the General Load Balancing group that corresponds to the MD-CM-SG of the CM. The selection of the Restricted Load Balancing group is achieved by first matching the CM in the RestrictCmCfg Object and if no match is found, by selecting the best match within the ResGrpCfg object.

The best match within the ResGrpCfg follows the MULPI requirements on precedences of the CM signaled TLVs: ServiceType ID and Load Balancing Group ID (for backward compatibility of provisioned Group IDs).

References: [MULPIv3.1], Channel Assignment During Registration section.

**Table 7-26 - CmtsCmParams Object Attributes**

Attribute Name	Type	Access	Type Constraints	Units	Default
CmtsCmRegStatusId	UnsignedInt	read-only		N/A	N/A
ProvGrpId	UnsignedInt	read-only		N/A	N/A
CurrentGrpId	UnsignedInt	read-only		N/A	N/A
ProvServiceTypeID	String	read-only	SIZE (0..16)	N/A	N/A
CurrentServiceTypeID	String	read-only	SIZE (0..16)	N/A	N/A
PolicyId	UnsignedInt	read-only		N/A	N/A
Priority	UnsignedInt	read-only		N/A	N/A

#### 7.2.1.4.1.1 CmtsCmParams Object Attributes

##### 7.2.1.4.1.1.1 CmtsCmRegStatusId

This key is the CMTS generated unique identifier of a CM for status report purposes.

##### 7.2.1.4.1.1.2 ProvGrpId

This attribute indicates the provisioned Load Balancing Group ID TLV the CM signaled to the CMTS during registration, or zero if not provisioned in the CM.

##### 7.2.1.4.1.1.3 CurrentGrpId

This attribute references the Load Balancing Group Identifier (Id attribute from the GrpStatus object) associated with the cable modem after the CMTS validates the CM Load Balancing Group ID TLV, Service Type ID TLV and Restricted CM list. The value zero indicates that the Load Balancing Group is invalid, or the General Load Balancing Group is invalid due ambiguous topology resolution.

##### 7.2.1.4.1.1.4 ProvServiceTypeID

This attribute indicates the provisioned Service Type ID TLV the CM signaled to the CMTS during registration, or the zero-length string if not provisioned in the CM.

##### 7.2.1.4.1.1.5 CurrentServiceTypeID

This attribute represents the Service Type ID the CMTS picked from the Restricted Group of Restricted CM list, or the Service Type Id TLV the CM signaled to the CMTS during registration, or the zero-length string if none was used.

##### 7.2.1.4.1.1.6 PolicyId

This attribute references the Load Balancing Policy ID associated to the cable modem either from the configuration file or from the general or Restricted Load Balancing Groups CMTS configuration.

### 7.2.1.4.1.1.7 Priority

This attribute references the Load Balancing Priority associated to the cable modem either from the configuration file or from the General or Restricted Load Balancing Groups CMTS configuration.

### 7.2.1.4.2 GrpStatus

This object represents the status of all General and Restricted Load Balancing Groups in this CMTS. This object summarizes the load balancing parameters that applies to CMTS system wide Load Balancing Groups. The Load Balancing Groups defined in this object include the configured Restricted Load Balancing Groups and the General Load Balancing Groups derived from the GeneralGrpCfg object.

**Table 7-27 - GrpStatus Object Attributes**

Attribute Name	Type	Access	Type Constraints	Units	Default
Id	UnsignedInt	read-only		N/A	N/A
CfgIdOrZero	UnsignedInt	read-only		N/A	N/A
MdIfIndex	InterfaceIndexOrZero	read-only	Interface Index of the MAC interface	N/A	N/A
MdCmSgId	UnsignedInt	read-only		N/A	N/A
DsChList	ChannelList	read-only		N/A	N/A
UsChList	ChannelList	read-only		N/A	N/A
Enable	Boolean	read-only		N/A	N/A
InitTech	ChChgInitTechMap	read-only		N/A	N/A
PolicyId	UnsignedInt	read-only		N/A	N/A
ChgOverSuccess	Counter32	read-only		N/A	N/A
ChgOverFails	Counter32	read-only		N/A	N/A

#### 7.2.1.4.2.1 GrpStatus Object Attributes

##### 7.2.1.4.2.1.1 Id

This key represents an unique identifier of a Load Balancing Group in the CMTS.

##### 7.2.1.4.2.1.2 CfgIdOrZero

This attribute references the Id attribute of the instance of the ResGrpCfg this instance corresponds to. The value zero indicates that the instance corresponds to a General Load Balancing Group.

##### 7.2.1.4.2.1.3 MdIfIndex

This attribute represents the MAC domain where the Load Balancing Group applies. The value zero is allowed to indicate that vendor-specific mechanisms are used in load balancing operations. For example, to provide Load Balancing Groups across MAC domains.

##### 7.2.1.4.2.1.4 MdCmSgId

This attribute corresponds to the MD-CM-SG-ID that includes all the upstream and downstream channels of the Load Balancing Group. The value zero indicates that this instance corresponds to a Restricted Load Balancing Group. If there are vendor-specific Load Balancing Groups configuration (e.g., MdIfIndex set to zero), this attribute value might not be meaningful.

##### 7.2.1.4.2.1.5 DsChList

This attribute contains the list of downstream channels of the Load Balancing Group. If there are vendor-specific Load Balancing Groups configuration (e.g., MdIfIndex set to zero), this attribute value might not be meaningful.

**7.2.1.4.2.1.6 UsChList**

This attribute contains the list of the upstream channels of the Load Balancing Group. If there are vendor-specific Load Balancing Groups configuration (e.g., MdlfIndex set to zero), this attribute value might not be meaningful.

**7.2.1.4.2.1.7 Enable**

This attribute when set to 'true' indicates that load balancing is enabled on this group, or disabled if set to 'false'.

**7.2.1.4.2.1.8 InitTech**

This attribute indicates the initialization techniques that the CMTS can use when load balancing cable modems that are associated with the Load Balancing Group.

**7.2.1.4.2.1.9 PolicyId**

This attribute indicates the Policy that the CMTS can use when load balancing cable modems that are associated with the Load Balancing Group.

**7.2.1.4.2.1.10 ChgOverSuccess**

This attribute counts the number of successful Autonomous Load Balancing operations associated with this Load Balancing Group.

**7.2.1.4.2.1.11 ChgOverFails**

This attribute counts the number of failed Autonomous load balancing operations associated with this Load Balancing Group.

**7.2.1.4.3 ChgOverStatus<sup>85</sup>**

This object reports the status of cable modems instructed to move to a new downstream and/or upstream channel or channel sets when commanded either by an operation in the ChgOver object. An instance in this object is created for each change-over operation committed successfully. If the instance value attribute is not final (the change-over operation is still pending completion), this instance is expected to be updated at some point later to reflect the final state of the change-over operation.

**Table 7-28 - ChgOverStatus Object**

Attribute Name	Type	Access	Type Constraints	Units	Default
Id	unsignedInt	key			
MacAddr	MacAddress	read-only			
InitTech	ChChgInitTechMap	read-only			
DownFrequency	unsignedInt	read-only			
MdlfIndex	InterfaceIndexOrZero	read-only	Interface Index of the MAC interface		
RcpId	RcpId	read-only			
RcclId	unsignedByte	read-only			
UsChSet	ChannelList	read-only			
ServiceFlowInfo	hexBinary	read-only			
Cmd	Enum	read-only	ucc(1) dcc(2) dbc(3) crossMD(4)		
TransactionId	unsignedShort	read-only			

<sup>85</sup> Moved from Section 6 per CCAP-OSSiv3.1-N-16.1433-1 on 5/13/16 by KB.

Attribute Name	Type	Access	Type Constraints	Units	Default
Value	Enum	read-only	messageSent(1) noOpNeeded(2) modemDeparting(3) waitToSendMessage(4) cmOperationRejected(5) cmmtsOperationRejected(6) timeOutT13(7) timeOutT15(8) rejectinit(9) success(10) dbcTimeout(11)		
Update	TimeStamp	read-only			

#### 7.2.1.4.3.1 Id

This key represents a monotonically increasing value for the record that stores the status of the change-over operation. When the ChOverStatus object exceeds the size limit of this object the lowest Id value instances are removed so that the total number of entries no longer exceeds the size limit allowing the CMTS to maintain the most current entries.

#### 7.2.1.4.3.2 MacAddr

This attribute represents the Mac address set in the ChgOver object commit operation.

#### 7.2.1.4.3.3 InitTech

The initialization technique set in change-over operation.

#### 7.2.1.4.3.4 DownFrequency

This attribute represents the Downstream frequency set in the ChgOver object commit operation, or zero

#### 7.2.1.4.3.5 MdIfIndex

This attribute represents the MAC Domain Interface index set in the ChgOver object commit operation, or zero.

#### 7.2.1.4.3.6 Rcpld

This attribute represents the RCP-ID set in the MultipleChChgOver object commit operation, or all zeros RCP-ID value.

#### 7.2.1.4.3.7 RcclD

This attribute represents the RCC Status Index set in the ChgOver object commit operation, or zero.

#### 7.2.1.4.3.8 UsChSet

This attribute represents the Upstream Channel Set in the ChgOver object commit operation, or zero.

#### 7.2.1.4.3.9 ServiceFlowInfo

This attribute represents the list of Service Flow-Channel Set ID pairs set in the ChgOver object commit operation, or zero-length string.

#### 7.2.1.4.3.10 Cmd

The load balancing MAC Management Message exchange type used by the CMTS for the change-over operation in the ChgOver object commit operation.

- 'ucc' indicates the usage of Upstream Channel Change (UCC) messages exchange.
- 'dcc' indicates the usage of Dynamic Channel Change (DCC) messages exchange.
- 'dbc' indicates the usage of Dynamic Bonding Change (DCC) messages exchange
- 'crossMD' although this term does not correspond to a MAC Management Message type, it indicates the movement of a CM to a different MAC Domain that includes a sequence of different MAC Management Messages types (i.e., DCC to move the CM to the correct MAC Domain, followed by channel assignment in REG-RSP-MP).

#### 7.2.1.4.3.11 TransactionId

This attribute represents the transaction Id value used in the change-over operation.

#### 7.2.1.4.3.12 Value

This attribute represents the status of the specified change-over operation. The enumerations are:

Change-over using DCC message exchange:

- 'modemDeparting'

The cable modem has responded with a change-over response of either a DCC-RSP with a confirmation code of depart(180) or a UCC-RSP.

- 'timeOutT13'

Failure due to no DCC-RSP with confirmation code depart(180) received prior to expiration of the T13 timer.

- 'timeOutT15'

T15 timer timed out prior to the arrival of a bandwidth request, RNG-REQ message, or DCC-RSP message with confirmation code of arrive(181) from the cable modem.

Change-over using DBC message exchange:

- 'dbcTimeout'

The number of DBC-REQ retries was exceeded and no DBC-RSP was received

Change-over CMTS verifications:

- 'messageSent'

The CMTS has sent a DOCSIS MAC message request to instruct the CM to do the change-over operation.

- 'noOpNeed'

A change-over operation was requested in which neither the DS and US channels where the CM is operational changed.

- 'waitToSendMessage'

The specified operation is active and CMTS is waiting to send the channel change message with channel info to the cable modem.

- 'cmOperationRejected'

Channel Change operation was rejected by the cable modem.

- 'cmtsOperationRejected'

Channel Change operation was rejected by the Cable Modem Termination System.

- 'rejectInit'

Operation rejected due to unsupported initialization tech requested.

- 'success'

CMTS received an indication that the CM successfully completed the change-over operation. e.g., If an initialization technique of re-initialize the MAC is used, success is indicated by the receipt of a DCC-RSP message with a confirmation code of depart(180) or DBC confirmation code ok/success. In all other DCC cases, success is indicated by: (1) the CMTS received a DCC-RSP message with confirmation code of arrive(181) or (2) the CMTS internally confirms the presence of the CM on the new channel(s).

7.2.1.4.3.13 Update

The value of sysUpTime when the attribute Value of this instance was last updated.

7.2.1.4.4 LoadBalanceStatus

This object represents the control and status of Autonomous Load Balancing Operations.

**Table 7-29 - LoadBalanceStatus Object**

Attribute Name	Type	Access	Type Constraints	Units	Default
EnableError	AdminString	read-only	SIZE(0..255)		"H

7.2.1.4.4.1 EnableError

This attribute represents a text message that describes a failure to enable load balancing due configuration errors, or other considerations. The zero-length string indicates no errors occurred during the last Autonomous Load Balancing activation.

**7.2.1.5 DOCS-MCAST-AUTH-MIB**

The objects in the DOCS-MCAST-AUTH-MIB are taken from the DOCS-MCAST-AUTH-MIB specified in Annex Q of [OSSv3.0] and used without modification for the CCAP.

Reference: [OSSv3.0], DOCS-MCAST-AUTH-MIB



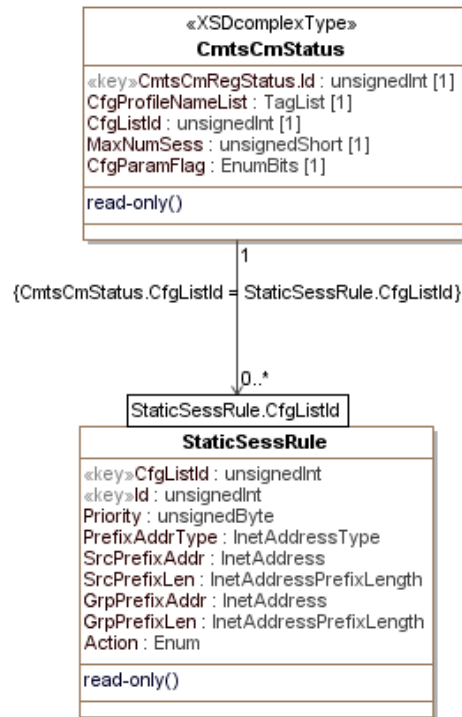

Figure 7-6 - DOCS-MCAST-AUTH-MIB Performance Management Objects

7.2.1.5.1 CmtsCmStatus

This object maintains per-CM status of Multicast Authorization policies to be applied to this CM. The CM acquires these policy parameters through the CM registration process, or in the absence of some or all of those parameters, from the Ctrl object.

This object is meaningful when the Ctrl Enable attribute is set to 'enable'.

In the process of authorizing a CM client's session request, the CMTS MUST check rules defined in StaticSessRule object and then rules defined in ProfileSessRule object. In the case of multiple multicast session matches, the rule priority attribute defines the final selected session rule. The selection of a session rules when multiple matches have the same priority is vendor specific.

The CMTS MAY report in the CmtsCmStatus object CMs that do not signal any IP Multicast Authorization Encodings in the registration process.

Table 7-30 - CmtsCmStatus Object Attributes

Attribute Name	Type	Access	Type Constraints	Units	Default
CmtsCmRegStatusId	UnsignedInt	key	1..4294967295	N/A	N/A
CfgProfileNameList	TagList	read-only		N/A	N/A
CfgListId	UnsignedInt	read-only		N/A	N/A
MaxNumSess	UnsignedShort	read-only		sessions	N/A
CfgParamFlag	EnumBits	read-only	profile(0) staticMulticast(1) maxNumSessions(2)	N/A	N/A

### 7.2.1.5.1.1 CmtsCmStatus Object Attributes

#### 7.2.1.5.1.1.1 CmtsCmRegStatusId

This attribute is a key which uniquely identifies the CM. This attribute matches an index value of the CMTS CM Registration Status object.

References: Section 7.2.2.2.1, CmtsCmRegStatus.

#### 7.2.1.5.1.1.2 CfgProfileNameList

This attribute indicates the set of Profile Names associated with the CM.

This attribute indicates the CM signaled 'IP Multicast Authorization Profile Name' encodings during the CM registration process, or in the absence of instances of that config file parameter, the DefProfileNameList attribute from the Ctrl object.

References: [MULPIv3.1] IP Multicast Profile Name Subtype sections.

#### 7.2.1.5.1.1.3 CfgListId

This attribute identifies the reference to a CMTS created Session Rule List based on the CM signaled 'IP Multicast Authorization Static Session Rule' encodings. The CMTS may reuse this attribute value to reference more than one CM that have signaled the same list of Session Rules to the CMTS.

The value zero indicates that the CM did not signal Multicast Session Rules to the CMTS or the CMTS does not support the StaticSessRule, in which case, the CMTS ignores any CM signaled Session Rule encodings during registration.

References: [MULPIv3.1] IP Multicast Join Authorization Static Session Rule Subtype section in the Common Radio Frequency Interface Encodings Annex.

#### 7.2.1.5.1.1.4 MaxNumSess

This attribute indicates the CM signaled value in Maximum Multicast Sessions Encoding during the CM registration process. If this value is missing the DefMaxNumSess attribute of the Ctrl object is used to determine the maximum number of multicast sessions this client may forward. The value 0 indicates that no dynamic joins are permitted. The value 65535 (the largest valid value) indicates that the CMTS permits any number of sessions to be joined by clients reached through the CM.

References: [MULPIv3.1] Maximum Multicast Sessions Encoding section in the Common Radio Frequency Interface Encodings Annex.

#### 7.2.1.5.1.1.5 CfgParamFlag

This attribute represents the functions that are activated through the registration process.

The bit 'profile' indicates whether the CM signaled 'IP Multicast Authorization Profile Name Subtype' encodings.

The bit 'staticMulticast' indicates whether the CM signaled 'IP Multicast Authorization Static Session Rule Subtype' encodings.

The bit 'maxNumSessions' indicates whether the CM signaled the 'Maximum Multicast Sessions' encoding.

### 7.2.1.5.2 StaticSessRule

This object defines the Session authorization Rules based on the CM or group of CMs signaled in IP Multicast Join Authorization Static Session Subtype encoding This object reflects the Static Session rules that were included in the CM registration request message.

The CMTS MAY persist all instances of the StaticSessRule object across reinitializations.

References: [MULPIv3.1] IP Multicast Join Authorization Static Session Rule Subtype section in the Common Radio Frequency Interface Encodings Annex.

**Table 7-31 - StaticSessRule Object**

Attribute Name	Type	Access	Type Constraints	Units	Default
CfgListId	unsignedInt	key	1..4294967295	N/A	N/A
Id	unsignedInt	key	1..4294967295	N/A	N/A
Priority	unsignedByte	read-only		N/A	N/A
PrefixAddrType	InetAddressType	read-only	ipv4(1) ipv6(2)	N/A	N/A
SrcPrefixAddr	InetAddress	read-only		N/A	N/A
SrcPrefixLen	InetAddressPrefixLength	read-only		N/A	N/A
GrpPrefixAddr	InetAddress	read-only		N/A	N/A
GrpPrefixLen	InetAddressPrefixLength	read-only		N/A	N/A
Action	Enum	read-only	permit(1) deny(2)	N/A	N/A

#### 7.2.1.5.2.1 CfgListId

This attribute contains a CMTS-derived value for a set of multicast static session rules associated to one or more CMs.

#### 7.2.1.5.2.2 Id

This attribute provides an identifier for each Multicast Authorization Static Session rule in the IP Multicast Join Authorization Static Session SubType communicated by a CM or group of CMs during registration.

#### 7.2.1.5.2.3 Priority

This attribute defines the rule priority for the static session rule. Higher values indicate a higher priority. If more than one session rule matches a joined session, the session rule with the highest rule priority determines the authorization action.

#### 7.2.1.5.2.4 PrefixAddrType

This attribute identifies the address family for the multicast session (S,G) which corresponds to the SrcPrefixAddr and GrpPrefixAddr attributes respectively.

#### 7.2.1.5.2.5 SrcPrefixAddr

This attribute identifies a specific Multicast Source Address defined for this rule. A Source Address that is all zeros is defined as 'all source addresses (\*, G)'. Source Prefix Addresses are unicast host addresses.

References: [RFC 3569] section 6; [RFC 3306] sections 5 and 6.

#### 7.2.1.5.2.6 SrcPrefixLen

This attribute identifies the prefix length associated with a range of Source (S) IP multicast group addresses. For group or ASM-based sessions this attribute is set to 0.

#### 7.2.1.5.2.7 GrpPrefixAddr

This attribute is the IP address corresponding to an IP multicast group.

#### 7.2.1.5.2.8 GrpPrefixLen

This attribute identifies the prefix length associated with a range of Group Destination IP multicast addresses.

#### 7.2.1.5.2.9 Action

This attribute specifies the authorization action for a session join attempt that matches the session rule.

The value 'accept' indicates that the rule permits a matching multicast join request is allowed. The value 'deny' indicates that a matching multicast join request is denied.

**7.2.1.6 DOCSIS QoS State Information Model<sup>86</sup>**

This section defines state performance management objects from the DOCS-QOS3-MIB.

Reference: [DOCS-QOS3-MIB]

---

<sup>86</sup> Modified per CCAP-OSSiv3.1-N-16.1528-2 on 11/15/16 by KB; per CCAP-OSSiv3.1-N-16.1618-3 on 11/17/16 by KB.

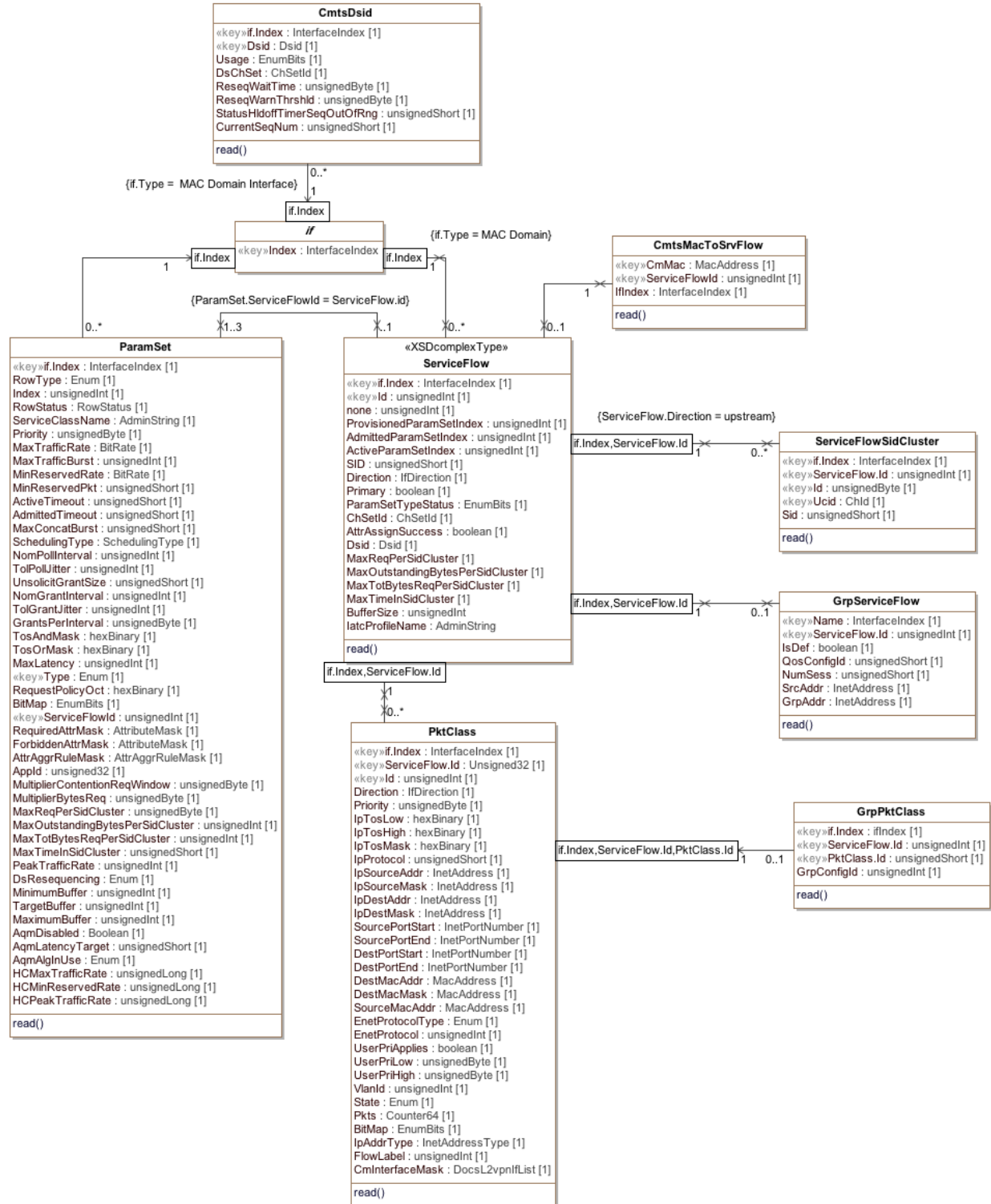

Figure 7-7 – DOCSIS QoS State Performance Management Information Model<sup>87</sup>

<sup>87</sup> Modified per CCAP-OSSv3.1-N-15.1307-3 on 6/1/15 by KB; per CCAP-OSSv3.1-N-16.1455-2 on 5/13/16 by KB; per CCAP-OSSv3.1-N-16.1528-2 on 11/15/16 by KB.

### 7.2.1.6.1 PktClass

This object describes the packet classification configured on the CM or CMTS. The model is that a packet either received as input from an interface or transmitted for output on an interface may be compared against an ordered list of rules pertaining to the packet contents. Each rule is an instance of this object. A matching rule provides a Service Flow ID to which the packet is classified. All rules need to match for a packet to match a classifier. The attributes in this row correspond to a set of Classifier Encoding parameters in a DOCSIS MAC management message. The BitMap attribute indicates which particular parameters were present in the classifier as signaled in the DOCSIS message. If the referenced parameter was not present in the signaled Classifier, the corresponding attribute in this instance reports a value as specified by that attribute description.

References: [MULPIv3.1] Service Flows and Classifiers section.

**Table 7-32 - PktClass Object<sup>88</sup>**

Attribute Name	Type	Access	Type Constraints	Units	Default
ifIndex	InterfaceIndex	Key	Interface Index of MAC Domain interface	N/A	N/A
ServiceFlowId	Unsigned32	Key	1..4294967295	N/A	N/A
Id	unsignedInt	Key	1..65535	N/A	N/A
Direction	IfDirection	read-only		N/A	N/A
Priority	unsignedByte	read-only		N/A	N/A
IpTosLow	hexBinary	read-only		N/A	N/A
IpTosHigh	hexBinary	read-only		N/A	N/A
IpTosMask	hexBinary	read-only		N/A	N/A
IpProtocol	unsignedShort	read-only		N/A	N/A
IpSourceAddr	InetAddress	read-only		N/A	N/A
IpSourceMask	InetAddress	read-only		N/A	N/A
IpDestAddr	InetAddress	read-only		N/A	N/A
IpDestMask	InetAddress	read-only		N/A	N/A
SourcePortStart	InetAddress	read-only		N/A	N/A
SourcePortEnd	InetAddress	read-only		N/A	N/A
DestPortStart	InetAddress	read-only		N/A	N/A
DestPortEnd	InetAddress	read-only		N/A	N/A
IcmpTypeLow	unsignedByte	read-only		N/A	N/A
IcmpTypeHigh	unsignedByte	read-only		N/A	N/A
DestMacAddr	MacAddress	read-only		N/A	N/A
DestMacMask	MacAddress	read-only		N/A	N/A
SourceMacAddr	MacAddress	read-only		N/A	N/A
EnetProtocolType	Enum	read-only		N/A	N/A
EnetProtocol	Integer32	read-only	0..65535	N/A	N/A
UserPriLow	unsignedByte	read-only		N/A	N/A
UserPriHigh	unsignedByte	read-only		N/A	N/A
VlanId	unsignedInt	read-only		N/A	N/A
State	Enum	read-only	active(1) inactive(2)	N/A	N/A
Pkts	Counter64	read-only		packets	

<sup>88</sup> Modified per CCAP-OSSiv3.1-N-16.1455-2 on 5/13/16 by KB.

Attribute Name	Type	Access	Type Constraints	Units	Default
BitMap	EnumBits	read-only	rulePriority(0), activationState(1), ipTos(2), ipProtocol(3), ipSourceAddr(4), ipSourceMask(5), ipDestAddr(6), ipDestMask(7), sourcePortStart(8), sourcePortEnd(9), destPortStart(10), destPortEnd(11), destMac(12), sourceMac(13), ethertype(14), userPri(15), vlanId(16), flowLabel(17), cmInterfaceMask(18), icmpTypeLow(19), icmpTypeHigh(20)	N/A	N/A
IpAddrType	InetAddressType	read-only		N/A	N/A
FlowLabel	unsignedInt	read-only	0..1048575	N/A	N/A
CmInterfaceMask	DocsL2vpnIfList	read-only		N/A	N/A

#### 7.2.1.6.1.1 ifIndex

This key represents the interface index of the MAC Domain of the Service Flow.

#### 7.2.1.6.1.2 ServiceFlowId

This key represents an identifier assigned to a Service Flow by CMTS within a MAC Domain. The value 0 is used only for the purpose of reporting instances pertaining UDCs and not used for association of QoS classifiers to service flows.

#### 7.2.1.6.1.3 Id

This key indicates the assigned identifier to the packet classifier instance by the CMTS, which is unique per Service Flow. For UDCs this corresponds to the Service Flow Reference of the classifier.

References: [MULPIv3.1] Classifier Identifier section in the Common Radio Frequency Interface Encodings Annex.

#### 7.2.1.6.1.4 Direction

This attribute indicates the direction to which the classifier is applied.

#### 7.2.1.6.1.5 Priority

This attribute specifies the order of evaluation of the classifiers. The higher the value, the higher the priority. The value of 0 is used as default in provisioned Service Flows Classifiers. The default value of 64 is used for dynamic Service Flow Classifiers. If the referenced parameter is not present in a classifier, this attribute reports the default value as defined above.

References: [MULPIv3.1] Rule Priority section in the Common Radio Frequency Interface Encodings Annex.

#### 7.2.1.6.1.6 IpTosLow

This attribute indicates the low value of a range of ToS byte values. If the referenced parameter is not present in a classifier, this attribute reports the value of 0. The IP ToS octet as originally defined in [RFC 791] has been



superseded by the 6-bit Differentiated Services Field (DSField, [RFC 3260]) and the 2-bit Explicit Congestion Notification Field (ECN field, [RFC 3168]). This object is defined as an 8-bit octet as defined by the DOCSIS Specification for packet classification.

References: [MULPIv3.1] IPv4 Type of Service Range and Mask and IPv6 Traffic Class Range and Mask sections in the Common Radio Frequency Interface Encodings Annex.

#### 7.2.1.6.1.7 IpTosHigh

This attribute indicates the 8-bit high value of a range of ToS byte values. If the referenced parameter is not present in a classifier, this attribute reports the value of 0. The IP ToS octet as originally defined in [RFC 791] has been superseded by the 6-bit Differentiated Services Field (DSField, [RFC 3260]) and the 2-bit Explicit Congestion Notification Field (ECN field, [RFC 3168]). This object is defined as an 8-bit octet as defined by the DOCSIS Specification for packet classification.

References: [MULPIv3.1] IPv4 Type of Service Range and Mask and IPv6 Traffic Class Range and Mask sections in the Common Radio Frequency Interface Encodings Annex.

#### 7.2.1.6.1.8 IpTosMask

This attribute indicates the mask value is bitwise ANDed with ToS byte in an IP packet, and this value is used for range checking of TosLow and TosHigh. If the referenced parameter is not present in a classifier, this attribute reports the value of 0. The IP ToS octet as originally defined in [RFC 791] has been superseded by the 6-bit Differentiated Services Field (DSField, [RFC 3260]) and the 2-bit Explicit Congestion Notification Field (ECN field, [RFC 3168]). This object is defined as an 8-bit octet per the DOCSIS Specification for packet classification.

References: [MULPIv3.1] IPv4 Type of Service Range and Mask and IPv6 Traffic Class Range and Mask sections in the Common Radio Frequency Interface Encodings Annex.

#### 7.2.1.6.1.9 IpProtocol

This attribute indicates the value of the IP Protocol field required for IP packets to match this rule. The value 256 matches traffic with any IP Protocol value. The value 257 by convention matches both TCP and UDP. If the referenced parameter is not present in a classifier, this attribute reports the value of 258.

References: [MULPIv3.1] IP Protocol and IPv6 Next Header Type sections in the Common Radio Frequency Interface Encodings Annex.

#### 7.2.1.6.1.10 IpSourceAddr

This attribute specifies the value of the IP Source Address required for packets to match this rule. An IP packet matches the rule when the packet IP Source Address bitwise ANDed with the IpSourceMask value equals the IpSourceAddr value. The address type of this object is specified by IpAddrType. If the referenced parameter is not present in a classifier, this object reports the value of '00000000'H.

References: [MULPIv3.1] IPv4 Source Address and IPv6 Source Address sections in the Common Radio Frequency Interface Encodings Annex.

#### 7.2.1.6.1.11 IpSourceMask

This attribute specifies which bits of a packet's IP Source Address are compared to match this rule. An IP packet matches the rule when the packet source address bitwise ANDed with the IpSourceMask value equals the IpSourceAddr value. The address type of this attribute is specified by IpAddrType. If the referenced parameter is not present in a classifier, this attribute reports the value of 'FFFFFFFF'H.

References: [MULPIv3.1] IPv4 Source Mask and IPv6 Source Prefix Length (bits) sections in the Common Radio Frequency Interface Encodings Annex.

#### 7.2.1.6.1.12 IpDestAddr

This attribute specifies the value of the IP Destination Address required for packets to match this rule. An IP packet matches the rule when the packet IP Destination Address bitwise ANDed with the IpDestMask value equals the IpDestAddr value. The address type of this attribute is specified by IpAddrType. If the referenced parameter is not present in a classifier, this attribute reports the value of '00000000'H.

References: [MULPIv3.1] IPv4 Destination Address and IPv6 Destination Address sections in the Common Radio Frequency Interface Encodings Annex.

#### 7.2.1.6.1.13 IpDestMask

This attribute specifies which bits of a packet's IP Destination Address are compared to match this rule. An IP packet matches the rule when the packet destination address bitwise ANDed with the IpDestMask value equals the IpDestAddr value. The address type of this attribute is specified by IpAddrType. If the referenced parameter is not present in a classifier, this attribute reports the value of 'FFFFFFFH'.

References: [MULPIv3.1] IPv4 Destination Mask and IPv6 Destination Prefix Length (bits) sections in the Common Radio Frequency Interface Encodings Annex.

#### 7.2.1.6.1.14 SourcePortStart

This attribute specifies the low-end inclusive range of TCP/UDP source port numbers to which a packet is compared. This attribute is irrelevant for non-TCP/UDP IP packets. If the referenced parameter is not present in a classifier, this attribute reports the value of 0.

References: [MULPIv3.1] TCP/UDP Source Port Start section in the Common Radio Frequency Interface Encodings Annex.

#### 7.2.1.6.1.15 SourcePortEnd

This attribute specifies the high-end inclusive range of TCP/UDP source port numbers to which a packet is compared. This attribute is irrelevant for non-TCP/UDP IP packets. If the referenced parameter is not present in a classifier, this attribute reports the value of 65535.

References: [MULPIv3.1] TCP/UDP Source Port End section in the Common Radio Frequency Interface Encodings Annex.

#### 7.2.1.6.1.16 DestPortStart

This attribute specifies the low-end inclusive range of TCP/UDP destination port numbers to which a packet is compared. If the referenced parameter is not present in a classifier, this attribute reports the value of 0.

References: [MULPIv3.1] TCP/UDP Destination Port Start section in the Common Radio Frequency Interface Encodings Annex.

#### 7.2.1.6.1.17 DestPortEnd

This attribute specifies the high-end inclusive range of TCP/UDP destination port numbers to which a packet is compared. If the referenced parameter is not present in a classifier, this attribute reports the value of 65535.

References: [MULPIv3.1] TCP/UDP Destination Port End section in the Common Radio Frequency Interface Encodings Annex.

#### 7.2.1.6.1.18 IcmpTypeLow

This attribute specifies the low-end inclusive range of the ICMP type numbers to which a packet is compared. If the referenced parameter is not present in a classifier, this attribute reports the value of 0.

References: [MULPIv3.1] TypeLow encodings section of the Common Radio Frequency Interface Annex.

#### 7.2.1.6.1.19 IcmpTypeHigh

This attribute specifies the high-end inclusive range of the ICMP type numbers to which a packet is compared. If the referenced parameter is not present in a classifier, this attribute reports the value of 255.

References: [MULPIv3.1] TypeHigh encodings section of the Common Radio Frequency Interface Annex.

#### 7.2.1.6.1.20 DestMacAddr

An Ethernet packet matches an entry when its destination MAC address bitwise ANDed with DestMacMask equals the value of DestMacAddr. If the referenced parameter is not present in a classifier, this attribute reports the value of '000000000000'H.

References: [MULPIv3.1] Destination MAC Address section in the Common Radio Frequency Interface Encodings Annex.

#### 7.2.1.6.1.21 DestMacMask

An Ethernet packet matches an entry when its destination MAC address bitwise ANDed with DestMacMask equals the value of DestMacAddr. If the referenced parameter is not present in a classifier, this attribute reports the value of '000000000000'H.

References: [MULPIv3.1] Destination MAC Address section in the Common Radio Frequency Interface Encodings Annex.

#### 7.2.1.6.1.22 SourceMacAddr

An Ethernet packet matches this entry when its source MAC address equals the value of this attribute. If the referenced parameter is not present in a classifier, this attribute reports the value of 'FFFFFFFFFFFF'.

References: [MULPIv3.1] Source MAC Address section in the Common Radio Frequency Interface Encodings Annex.

#### 7.2.1.6.1.23 EnetProtocolType

This attribute indicates the format of the layer 3 protocol ID in the Ethernet packet. A value of 'none' means that the rule does not use the layer 3 protocol type as a matching criteria. A value of 'ethertype' means that the rule applies only to frames that contain an EtherType value. Ethertype values are contained in packets using the Dec-Intel-Xerox (DIX) encapsulation or the RFC1042 Sub-Network Access Protocol (SNAP) encapsulation formats. A value of 'dsap' means that the rule applies only to frames using the IEEE802.3 encapsulation format with a Destination Service Access Point (DSAP) other than 0xAA (which is reserved for SNAP). A value of 'mac' means that the rule applies only to MAC management messages for MAC management messages. A value of 'all' means that the rule matches all Ethernet packets. If the Ethernet frame contains an 802.1P/Q Tag header (i.e., EtherType 0x8100), this attribute applies to the embedded EtherType field within the 802.1P/Q header. If the referenced parameter is not present in a classifier, this attribute reports the value of 0.

References: [MULPIv3.1] Ethertype/DSAP/MacType section in the Common Radio Frequency Interface Encodings Annex.

#### 7.2.1.6.1.24 EnetProtocol

If EnetProtocolType is 'none', this attribute is ignored when considering whether a packet matches the current rule. If EnetProtocolType is 'ethertype', this attribute gives the 16-bit value of the EtherType that the packet needs to match in order to match the rule. If EnetProtocolType is 'dsap', the lower 8 bits of this attribute's value needs to match the DSAP byte of the packet in order to match the rule. If EnetProtocolType is 'mac', the lower 8 bits of this attribute's value represent a lower bound (inclusive) of MAC management message type codes matched, and the upper 8 bits represent the upper bound (inclusive) of matched MAC message type codes. Certain message type codes are excluded from matching, as specified in the reference. If the Ethernet frame contains an 802.1P/Q Tag header (i.e., EtherType 0x8100), this attribute applies to the embedded EtherType field within the 802.1P/Q header. If the referenced parameter is not present in the classifier, the value of this attribute is reported as 0.

References: [MULPIv3.1] Ethertype/DSAP/MacType section in the Common Radio Frequency Interface Encodings Annex.

#### 7.2.1.6.1.25 UserPriLow

This attribute applies only to Ethernet frames using the 802.1P/Q tag header (indicated with EtherType 0x8100). Such frames include a 16-bit Tag that contains a 3-bit Priority field and a 12-bit VLAN number. Tagged Ethernet packets need to have a 3-bit Priority field within the range of PriLow to PriHigh in order to match this rule. If the referenced parameter is not present in the classifier, the value of this attribute is reported as 0.

References: [MULPIv3.1] IEEE 802.1P User\_Priority section in the Common Radio Frequency Interface Encodings Annex.

#### 7.2.1.6.1.26 UserPriHigh

This attribute applies only to Ethernet frames using the 802.1P/Qtag header (indicated with EtherType 0x8100). Such frames include a 16-bit Tag that contains a 3-bit Priority field and a 12-bit VLAN number. Tagged Ethernet packets need to have a 3-bit Priority field within the range of PriLow to PriHigh in order to match this rule. If the referenced parameter is not present in the classifier, the value of this attribute is reported as 7.

References: [MULPIv3.1] IEEE 802.1P User\_Priority section in the Common Radio Frequency Interface Encodings Annex.

#### 7.2.1.6.1.27 VlanId

This attribute applies only to Ethernet frames using the 802.1P/Q tag header. Tagged packets need to have a VLAN Identifier that matches the value in order to match the rule. If the referenced parameter is not present in the classifier, the value of this attribute is reported as 0.

References: [MULPIv3.1] IEEE 802.1Q VLAN\_ID section in the Common Radio Frequency Interface Encodings Annex.

#### 7.2.1.6.1.28 State

This attribute indicates whether or not the classifier is enabled to classify packets to a Service Flow. If the referenced parameter is not present in the classifier, the value of this attribute is reported as 'true'.

References: [MULPIv3.1] Classifier Activation State section in the Common Radio Frequency Interface Encodings Annex.

#### 7.2.1.6.1.29 Pkts

This attribute counts the number of packets that have been classified using this entry. This includes all packets delivered to a Service Flow maximum rate policing function, whether or not that function drops the packets. This counter's last discontinuity is the ifCounterDiscontinuityTime for the same ifIndex that indexes this attribute.

#### 7.2.1.6.1.30 BitMap

This attribute indicates which parameter encodings were actually present in the DOCSIS packet classifier encoding signaled in the DOCSIS message that created or modified the classifier. Note that Dynamic Service Change messages have replace semantics, so that all non-default parameters need to be present whether the classifier is being created or changed. A bit of this attribute is set to 1 if the parameter indicated by the comment was present in the classifier encoding, and to 0 otherwise. Note that BITS are encoded most significant bit first, so that if, for example, bits 6 and 7 are set, this attribute is encoded as the octet string '030000'H.

#### 7.2.1.6.1.31 IpAddrType

This attribute indicates the type of the Internet address for IpSourceAddr, IpSourceMask, IpDestAddr, and IpDestMask. If the referenced parameter is not present in a classifier, this object reports the value of 'ipv4'.

### 7.2.1.6.1.32 FlowLabel

This attribute represents the Flow Label field in the IPv6 header to be matched by the classifier. The value zero indicates that the Flow Label is not specified as part of the classifier and is not matched against the packets.

References: [MULPIv3.1] IPv6 Flow Label section in the Common Radio Frequency Interface Encodings Annex.

### 7.2.1.6.1.33 CmlInterfaceMask

This attribute represents a bit-mask of the CM in-bound interfaces to which this classifier applies. This attribute only applies to QoS upstream Classifiers and upstream Drop Classifiers. For QoS downstream classifiers this object reports the zero-length string.

References: [MULPIv3.1] CM Interface Mask (CMIM) Encoding section in the Common Radio Frequency Interface Encodings Annex.

### 7.2.1.6.2 ParamSet Object

This object describes the set of QoS parameters defined in a managed device. DOCSIS 1.0 COS service profiles are not represented in this object. Each row corresponds to a DOCSIS QoS Parameter Set as signaled via DOCSIS MAC management messages. Each attribute of an instance of this object corresponds to one or part of one Service Flow Encoding. The BitMap attribute indicates which particular parameters were signaled in the original registration or dynamic service request message that created the QoS Parameter Set. In many cases, even if a QoS Parameter Set parameter was not signaled, the DOCSIS specification calls for a default value to be used. That default value is reported as the value of the corresponding attribute in this object instance. Many attributes are not applicable, depending on the Service Flow direction, upstream scheduling type or Service Flow bonding configuration. The attribute value reported in this case is specified by those attributes descriptions.

References: [MULPIv3.1] Service Flow Encodings section in the Common Radio Frequency Interface Encodings Annex.

**Table 7-33 - ParamSet Object<sup>89</sup>**

Attribute Name	Type	Access	Type Constraints	Units	Default (See attribute Description)
ifIndex	InterfaceIndex	key	Interface Index of MAC Domain interface	N/A	N/A
ServiceClassName	AdminString	read-only	SIZE (0..15)	N/A	N/A
Priority	unsignedByte	read-only	0..7	N/A	N/A
MaxTrafficRate	BitRate	read-only		bps	N/A
MaxTrafficBurst	unsignedInt	read-only		bytes	N/A
MinReservedRate	BitRate	read-only		bps	N/A
MinReservedPkt	unsignedShort	read-only		bytes	N/A
ActiveTimeout	unsignedShort	read-only		seconds	N/A
AdmittedTimeout	unsignedShort	read-only		seconds	N/A
MaxConcatBurst	unsignedShort	read-only		bytes	N/A
SchedulingType	SchedulingType	read-only		N/A	N/A
NomPollInterval	unsignedInt	read-only		microseconds	N/A
TolPollJitter	unsignedInt	read-only		microseconds	N/A
UnsolicitGrantSize	unsignedShort	read-only		bytes	N/A
NomGrantInterval	unsignedInt	read-only		microseconds	N/A
TolGrantJitter	unsignedInt	read-only		microseconds	N/A
GrantsPerInterval	unsignedByte	read-only	0..127	dataGrants	N/A
TosAndMask	hexBinary	read-only	SIZE (1)	N/A	N/A
TosOrMask	hexBinary	read-only	SIZE (1)	N/A	N/A

<sup>89</sup> Modified per CCAP-OSSiv3.1-N-16.1455-2 on 5/13/16 by KB.

Attribute Name	Type	Access	Type Constraints	Units	Default (See attribute Description)
MaxLatency	unsignedInt	read-only		microseconds	N/A
Type	Enum	key	active (1) admitted (2) provisioned (3)	N/A	N/A
RequestPolicyOct	hexBinary	read-only	SIZE (4)	N/A	N/A
BitMap	EnumBits	read-only	trafficPriority(0) maxTrafficRate(1) maxTrafficBurst(2) minReservedRate(3) minReservedPkt(4) activeTimeout(5) admittedTimeout(6) maxConcatBurst(7) schedulingType(8) requestPolicy(9) nomPollInterval(10) tolPollJitter(11) unsolicitGrantSize(12) nomGrantInterval(13) tolGrantJitter(14) grantsPerInterval(15) tosOverwrite(16) maxLatency(17) requiredAttrMask(18) forbiddenAttrMask(19) attrAggrMask(20) applicationId(21) multipCntnReqWindow(22) multipBytesReq(23) maxReqPerSidCluster(24) maxOutstandingBytesPerSidCluster(25) maxTotalBytesReqPerSidCluster(26) maximumTimeInSidCluster(27) peakTrafficRate(28) dsResequencing(29) minimumBuffer(30) targetBuffer(31) maximumBuffer(32) aqmEnabled(33) aqmLatencyTarget(34) dataRateUnit(35)		N/A
ServiceFlowId	unsignedInt	key	1.. 4294967295		N/A
RequiredAttrMask	AttributeMask	read-only			N/A
ForbiddenAttrMask	AttributeMask	read-only			N/A
AttrAggrRuleMask	AttrAggrRuleMask	read-only	SIZE (0   4)		N/A
AppId	unsignedInt	read-only			N/A
MultiplierContentionReqWindow	unsignedByte	read-only	0   4..12	eighths	N/A
MultiplierBytesReq	unsignedByte	read-only	1   2   4   8   16	requests	N/A
MaxReqPerSidCluster	unsignedByte	read-only		bytes	N/A
MaxOutstandingBytesPerSidCluster	unsignedInt	read-only		bytes	N/A
MaxTotBytesReqPerSidCluster	unsignedInt	read-only		bytes	N/A

Attribute Name	Type	Access	Type Constraints	Units	Default (See attribute Description)
MaxTimeInSidCluster	unsignedShort	read-only		milliseconds	N/A
PeakTrafficRate	unsignedInt	read-only		bps	N/A
DsResequencing	Enum	read-only	resequencingDsidIfBonded(0) noResequencingDsid(1) notApplicable(2)	NA	N/A
MinimumBuffer	unsignedInt	read-only		bytes	N/A
TargetBuffer	unsignedInt	read-only		bytes	N/A
MaximumBuffer	unsignedInt	read-only		bytes	N/A
AqmDisabled	Boolean	read-only			
AqmLatencyTarget	UnsignedShort	read-only	0..256	msec	
AqmAlgnUse	Enum	read-only	unknown(1) other(2) docsisPIE(3)		
HCMaxTrafficRate	UnsignedLong	read-only			
HCMInReservedRate	UnsignedLong	read-only			
HCPeakTrafficRate	UnsignedLong	read-only			

#### 7.2.1.6.2.1 ifIndex

This key represents the interface index of the MAC Domain of the Service Flow.

#### 7.2.1.6.2.2 ServiceClassName

This attribute represents the Service Class Name from which the parameter set values were derived. If the referenced parameter is not present in the corresponding DOCSIS QoS Parameter Set, this attribute returns the zero-length string.

References: [MULPIv3.1] Service Class Name section in the Common Radio Frequency Interface Encodings Annex.

#### 7.2.1.6.2.3 Priority

This attribute represents the relative priority of a Service Flow. Higher numbers indicate higher priority. This priority should only be used to differentiate Service Flow from identical parameter sets. This attribute returns 0 if the referenced parameter is not present in the corresponding DOCSIS QoS Parameter Set or if the parameter is not applicable.

References: [MULPIv3.1] Traffic Priority section in the Common Radio Frequency Interface Encodings Annex.

#### 7.2.1.6.2.4 MaxTrafficRate<sup>90</sup>

This attribute represents the maximum sustained traffic rate allowed for this Service Flow in bits/sec. It represents all MAC frame data PDUs from the bytes following the MAC header HCS to the end of the CRC. The number of bytes forwarded is limited during any time interval. The value 0 means no maximum traffic rate is enforced. This attribute applies to both upstream and downstream Service Flows. This attribute returns 0 if the referenced parameter is not present in the corresponding DOCSIS QoS Parameter Set, or if the parameter is not applicable. This attribute will also return 0 if DataRateUnitSetting is enabled and the resulting value cannot be represented in 32 bits, in which case HCMaxTrafficRate should be utilized.

References: [MULPIv3.1] Maximum Sustained Traffic Rate section in the Common Radio Frequency Interface Encodings Annex.

<sup>90</sup> Modified per CCAP-OSSiv3.1-N-16.1455-2 on 5/13/16 by KB.

#### 7.2.1.6.2.5 MaxTrafficBurst

This attribute specifies the token bucket size in bytes for this parameter set. The value is calculated from the byte following the MAC header HCS to the end of the CRC. This object is applied in conjunction with MaxTrafficRate to calculate maximum sustained traffic rate. If the referenced parameter is not present in the corresponding DOCSIS QoS Parameter Set, this attribute returns 3044 for scheduling types 'bestEffort', 'nonRealTimePollingService' and 'realTimePollingService'. If this parameter is not applicable, it is reported as 0.

References: [MULPIv3.1] Maximum Traffic Burst section in the Common Radio Frequency Interface Encodings Annex.

#### 7.2.1.6.2.6 MinReservedRate<sup>91</sup>

This attribute specifies the guaranteed minimum rate in bits/sec for this parameter set. The value is calculated from the byte following the MAC header HCS to the end of the CRC. The value of 0 indicates that no bandwidth is reserved. If the referenced parameter is not present in the corresponding DOCSIS QoS Parameter Set, this attribute returns 0. If the parameter is not applicable, it is reported as 0. This attribute will also return 0 if DataRateUnitSetting is enabled and the resulting value cannot be represented in 32 bits, in which case HCMinReservedRate should be utilized.

References: [MULPIv3.1] Minimum Reserved Traffic Rate section of the Common Radio Frequency Interface Encodings Annex.

#### 7.2.1.6.2.7 MinReservedPkt

This attribute specifies an assumed minimum packet size in bytes for which the MinReservedRate will be provided. The value is calculated from the byte following the MAC header HCS to the end of the CRC. If the referenced parameter is omitted from a DOCSIS QoS parameter set, the used and reported value is CMTS implementation and the CM reports a value of 0. If the referenced parameter is not applicable to the direction or scheduling type of the Service Flow, both CMTS and CM report the value 0.

References: [MULPIv3.1] Assumed Minimum Reserved Rate Packet Size, in the Common Radio Frequency Interface Encodings Annex.

#### 7.2.1.6.2.8 ActiveTimeout

This attribute specifies the maximum duration in seconds that resources remain unused on an active service flow before the CMTS signals that both the active and admitted parameter sets are null. The value 0 signifies an infinite amount of time. If the referenced parameter is not present in the corresponding DOCSIS QoS Parameter Set, this attribute returns 0.

References: [MULPIv3.1] Timeout for Active QoS Parameters section in the Common Radio Frequency Interface Encodings Annex.

#### 7.2.1.6.2.9 AdmittedTimeout

This attribute specifies the maximum duration in seconds that resources remain in admitted state before resources need to be released. The value of 0 signifies an infinite amount of time. If the referenced parameter is not present in the corresponding DOCSIS QoS Parameter Set, this attribute returns 200.

References: [MULPIv3.1] Timeout for Admitted QoS Parameters section in the Common Radio Frequency Interface Encodings Annex.

#### 7.2.1.6.2.10 MaxConcatBurst

This attribute specifies the maximum concatenated burst in bytes that an upstream Service Flow is allowed. The value is calculated from the FC byte of the Concatenation MAC Header to the last CRC byte of the last concatenated MAC frame, inclusive. The value of 0 specifies no maximum burst. If the referenced parameter is not present in the

---

<sup>91</sup> Modified per CCAP-OSSv3.1-N-16.1455-2 on 5/13/16 by KB.



corresponding DOCSIS QoS Parameter Set, this attribute returns the value of 1522 for scheduling types 'bestEffort', 'nonRealTimePollingService', and 'realTimePollingService'. If the parameter is not applicable, it is reported as 0.

References: [MULPIv3.1] Maximum Concatenated Burst section in the Common Radio Frequency Interface Encodings Annex.

#### 7.2.1.6.2.11 SchedulingType

This attribute specifies the upstream scheduling service used for upstream Service Flow. If the referenced parameter is not present in the corresponding DOCSIS QoS Parameter Set of an upstream Service Flow, this attribute returns the value of 'bestEffort'. For QoS parameter sets of downstream Service Flows, this attribute's value is reported as 'undefined'.

References: [MULPIv3.1] Service Flow Scheduling Type section in the Common Radio Frequency Interface Encodings Annex.

#### 7.2.1.6.2.12 NomPollInterval

This attribute specifies the nominal interval in microseconds between successive unicast request opportunities on an upstream Service Flow. This attribute applies only to upstream Service Flows with SchedulingType of value 'nonRealTimePollingService', 'realTimePollingService', and 'unsolicitedGrantServiceWithAD'. The parameter is mandatory for 'realTimePollingService'. If the parameter is omitted with 'nonRealTimePollingService', the CMTS uses an implementation-dependent value. If the parameter is omitted with 'unsolicitedGrantServiceWithAD(5)' the CMTS uses the value of the Nominal Grant Interval parameter. In all cases, the CMTS reports the value it is using when the parameter is applicable. The CM reports the signaled parameter value if it was signaled. Otherwise, it returns 0. If the referenced parameter is not applicable to the direction or scheduling type of the corresponding DOCSIS QoS Parameter Set, both CMTS and CM report this attribute's value as 0.

References: [MULPIv3.1] Polling Interval section in the Common Radio Frequency Interface Encodings Annex.

#### 7.2.1.6.2.13 TolPollJitter

This attribute specifies the maximum amount of time in microseconds that the unicast request interval may be delayed from the nominal periodic schedule on an upstream Service Flow. This parameter is applicable only to upstream Service Flows with a SchedulingType of 'realTimePollingService' or 'unsolicitedGrantServiceWithAD'. If the referenced parameter is applicable but not present in the corresponding DOCSIS QoS Parameter Set, the CMTS uses an implementation-dependent value and reports the value it is using. The CM reports a value of 0 in this case. If the parameter is not applicable to the direction or upstream scheduling type of the Service Flow, both CMTS and CM report this attribute's value as 0.

References: [MULPIv3.1] Tolerated Poll Jitter section in the Common Radio Frequency Interface Encodings Annex.

#### 7.2.1.6.2.14 UnsolicitGrantSize

This attribute specifies the unsolicited grant size in bytes. The grant size includes the entire MAC frame data PDU from the Frame Control byte to the end of the MAC frame. The referenced parameter is applicable only for upstream flows with a SchedulingType of 'unsolicitedGrantServiceWithAD' or 'unsolicitedGrantService', and it is mandatory when applicable. Both CMTS and CM report the signaled value of the parameter in this case. If the referenced parameter is not applicable to the direction or scheduling type of the corresponding DOCSIS QoS Parameter Set, both CMTS and CM report this attribute's value as 0.

References: [MULPIv3.1] Unsolicited Grant Size section in the Common Radio Frequency Interface Encodings Annex.

#### 7.2.1.6.2.15 NomGrantInterval

This attribute specifies the nominal interval in microseconds between successive data grant opportunities on an upstream Service Flow. The referenced parameter is applicable only for upstream flows with a SchedulingType of 'unsolicitedGrantServiceWithAD' or 'unsolicitedGrantService(6)', and it is mandatory when applicable. Both CMTS and CM report the signaled value of the parameter in this case. If the referenced parameter is not applicable to the

direction or scheduling type of the corresponding DOCSIS QoS Parameter Set, both CMTS and CM report this attribute's value as 0.

References: [MULPIv3.1] Nominal Grant Interval section in the Common Radio Frequency Interface Encodings Annex.

#### 7.2.1.6.2.16 TolGrantJitter

This attribute specifies the maximum amount of time in microseconds that the transmission opportunities may be delayed from the nominal periodic schedule. The referenced parameter is applicable only for upstream flows with a SchedulingType of 'unsolicitedGrantServiceWithAD' or 'unsolicitedGrantService(6)', and it is mandatory when applicable. Both CMTS and CM report the signaled value of the parameter in this case. If the referenced parameter is not applicable to the direction or scheduling type of the corresponding DOCSIS QoS Parameter Set, both CMTS and CM report this attribute's value as 0.

References: [MULPIv3.1] Tolerated Grant Jitter section in the Common Radio Frequency Interface Encodings Annex.

#### 7.2.1.6.2.17 GrantsPerInterval

This attribute specifies the number of data grants per Nominal Grant Interval (NomGrantInterval). The referenced parameter is applicable only for upstream flows with a SchedulingType of 'unsolicitedGrantServiceWithAD' or 'unsolicitedGrantService', and it is mandatory when applicable. Both CMTS and CM report the signaled value of the parameter in this case. If the referenced parameter is not applicable to the direction or scheduling type of the corresponding DOCSIS QoS Parameter Set, both CMTS and CM report this attribute's value as 0.

References: [MULPIv3.1] Grants per Interval section in the Common Radio Frequency Interface Encodings Annex.

#### 7.2.1.6.2.18 TosAndMask

This attribute specifies the AND mask for the IP ToS byte for overwriting an IPv4 packet's ToS value or IPv6 packet's Traffic Class value. The IP packet ToS byte is bitwise ANDed with TosAndMask, then the result is bitwise ORed with TosORMask and the result is written to the IP packet ToS byte. A value of 'FF'H for TosAndMask and a value of '00'H for TosOrMask means that the IP Packet ToS byte is not overwritten. This combination is reported if the referenced parameter is not present in a QoS Parameter Set. The IP ToS octet as originally defined in [RFC 791] has been superseded by the 6-bit Differentiated Services Field (DSField, [RFC 3260]) and the 2-bit Explicit Congestion Notification Field (ECN field, [RFC 3168]). The IPv6 Traffic Class octet [RFC 2460] is consistent with that new definition. Network operators should avoid specifying values of TosAndMask and TosORMask that would result in the modification of the ECN bits. In particular, operators should not use values of TosAndMask that have either of the least-significant two bits set to 0. Similarly, operators should not use values of TosORMask that have either of the least-significant two bits set to 1. Even though this attribute is only enforced by the CMTS, the CM reports the value as signaled in the referenced parameter.

References: [MULPIv3.1] IP Type Of Service (DSCP) Overwrite section in the Common Radio Frequency Interface Encodings Annex; [RFC 3168]; [RFC 3260]; [RFC 2460]; [RFC 791].

#### 7.2.1.6.2.19 TosOrMask

This attribute specifies the OR mask for the IPv4 ToS value or IPv6 Traffic Class value. See the description of TosAndMask for further details. The IP ToS octet, as originally defined in [RFC 791] has been superseded by the 6-bit Differentiated Services Field (DSField, [RFC 3260]) and the 2-bit Explicit Congestion Notification Field (ECN field, [RFC 3168]). The IPv6 Traffic Class octet [RFC 2460] is consistent with that new definition. Network operators should avoid specifying values of TosAndMask and TosORMask that would result in the modification of the ECN bits.

References: [MULPIv3.1] IP Type Of Service (DSCP) Overwrite section in the Common Radio Frequency Interface Encodings Annex; [RFC 3168]; [RFC 3260]; [RFC 2460]; [RFC 791].

#### 7.2.1.6.2.20 MaxLatency

This attribute specifies the maximum latency between the reception of a packet by the CMTS on its NSI and the forwarding of the packet to the RF interface. A value of 0 signifies no maximum latency is enforced. This attribute only applies to downstream Service Flows. If the referenced parameter is not present in the corresponding downstream DOCSIS QoS Parameter Set, this attribute returns 0. This parameter is not applicable to upstream DOCSIS QoS Parameter Sets, so its value is reported as 0 in that case.

References: [MULPIv3.1] Maximum Downstream Latency section in the Common Radio Frequency Interface Encodings Annex.

#### 7.2.1.6.2.21 Type

This key represents the QoS Parameter Set Type of the Service Flow. The following values are defined: 'active' Indicates the Active QoS parameter set, describing the service currently being provided by the DOCSIS MAC domain to the service flow. 'admitted' Indicates the Admitted QoS Parameter Set, describing services reserved by the DOCSIS MAC domain for use by the service flow. 'provisioned' Indicates the QoS Parameter Set defined in the DOCSIS CM Configuration file for the service flow.

References: [MULPIv3.1] Service Flow Scheduling Type section in the Common Radio Frequency Interface Encodings Annex.

#### 7.2.1.6.2.22 RequestPolicyOct

This attribute specifies which transmit interval opportunities the CM omits for upstream transmission requests and packet transmissions. This object takes its default value for downstream Service Flows. Unless otherwise indicated, a bit value of 1 means that a CM is not to use that opportunity for upstream transmission. The format of this string enumerated the bits from 0 to 31 from left to right, for example bit 0 corresponds to the left most bit of the fourth octet. (octets numbered from right to left). The bit positions are defined as follows:

'broadcastReqOpp' - all CMs broadcast request opportunities

'priorityReqMulticastReq' - priority request multicast request opportunities

'reqDataForReq' - request/data opportunities for requests

'reqDataForData' - request/data opportunities for data

'piggybackReqWithData' - piggyback requests with data

'concatenateData' - concatenate data

'fragmentData' - fragment data

'suppressPayloadHeaders' - suppress payload headers

'dropPktsExceedUGSize' - A value of 1 means that the service flow will drop packets that do not fit in the Unsolicited Grant size. If the referenced parameter is not present in a QoS Parameter Set, the value of this object is reported as '00000000'H.

References: [MULPIv3.1] Request/ Transmission Policy section in the Common Radio Frequency Interface Encodings Annex.

#### 7.2.1.6.2.23 BitMap<sup>92</sup>

This attribute indicates the set of QoS Parameter Set parameters actually signaled in the DOCSIS registration or dynamic service request message that created or modified the QoS Parameter Set. A bit is set to 1 when the associated parameter is present in the original request as follows:

'trafficPriority' Traffic Priority

'maxTrafficRate' Maximum Sustained Traffic Rate

<sup>92</sup> Modified per CCAP-OSSiv3.1-N-16.1455-2 on 5/13/16 by KB.

'maxTrafficBurst' Maximum Traffic Burst  
'minReservedRate' Minimum Reserved Traffic Rate  
'minReservedPkt' Assumed Minimum Reserved Rate Packet Size  
'activeTimeout' Timeout for Active QoS Parameters  
'admittedTimeout' Timeout for Admitted QoS Parameters  
'maxConcatBurst' Maximum Concatenated Burst  
'schedulingType' Service Flow Scheduling Type  
'requestPolicy' Request/Transmission Policy  
'nomPollInterval' Nominal Polling Interval  
'tolPollJitter' Tolerated Poll Jitter  
'unsolicitGrantSize' Unsolicited Grant Size  
'nomGrantInterval' Nominal Grant Interval  
'tolGrantJitter' Tolerated Grant Jitter  
'grantsPerInterval' Grants per Interval  
'tosOverwrite' IP Type of Service (DSCP) Overwrite  
'maxLatency' Maximum Downstream Latency  
'requiredAttrMask' Service Flow Required Attribute Mask  
'forbiddenAttrMask' Service Flow Forbidden Attribute Mask  
'attrAggrMask' Service Flow Attribute Aggregation Mask  
'applicationId' Application Identifier  
'multipCntnReqWindow' Multiplier to Contention Request Backoff Window  
'multipBytesReq' Multiplier to Number of Bytes Requested  
'maxReqPerSidCluster' Maximum Requests per SID Cluster  
'maxOutstandingBytesPerSidCluster' Maximum Outstanding Bytes per SID Cluster  
'maxTotalBytesReqPerSidCluster' Maximum Total Bytes Requested per SID Cluster  
'maximumTimeInSidCluster' Maximum Time in the SID Cluster  
'peakTrafficRate' Peak Traffic Rate  
'dsResequencing' - Downstream Resequencing  
'minimumBuffer' Minimum Buffer  
'targetBuffer' Target Buffer  
'maximumBuffer' Maximum Buffer  
'aqmDisabled' SF AQM Disabled  
'aqmLatencyTarget' SF AQM Latency Target  
'dataRateUnit' Data Rate Unit Setting

Note that when Service Class names are expanded, the registration or dynamic response message may contain parameters expanded by the CMTS based on a stored service class. These expanded parameters are not indicated by a 1 bit in this attribute. Note that even though some QoS Parameter Set parameters may not be signaled in a message

(so that the parameter's bit in this object is 0), the DOCSIS specification requires that default values be used. These default values are reported as the corresponding attribute.

References: [MULPIv3.1] Service Flow Encodings section in the Common Radio Frequency Interface Encodings Annex.

#### 7.2.1.6.2.24 ServiceFlowId

This key represents the Service Flow ID for the service flow.

References: [MULPIv3.1] Service Identifier section in the Common Radio Frequency Interface Encodings Annex.

#### 7.2.1.6.2.25 RequiredAttrMask

This attribute specifies the Required Attribute Mask to compare with the Provisioned Required Attributes when selecting the bonding groups for the service flow.

If the referenced parameter is not present in the corresponding DOCSIS QoS Parameter Set, this attribute returns '00000000'H.

References: [MULPIv3.1] Service Flow Required Attribute Mask section in the Common Radio Frequency Interface Encodings Annex.

#### 7.2.1.6.2.26 ForbiddenAttrMask

This attribute specifies the Forbidden Attribute Mask to compare with the Provisioned Forbidden Attributes when selecting the bonding groups for the service flow.

If the referenced parameter is not present in the corresponding DOCSIS QoS Parameter Set, this attribute returns '00000000'H.

References: [MULPIv3.1] Service Flow Forbidden Attribute Mask section in the Common Radio Frequency Interface Encodings Annex.

#### 7.2.1.6.2.27 AttrAggrRuleMask

This attribute specifies the Attribute Aggregation Mask to compare the Service Flow Required and Forbidden Attributes with the CMTS dynamically-created bonding group when selecting the bonding groups for the service flow.

If the referenced parameter is not present in the corresponding DOCSIS QoS Parameter Set, this attribute returns '00000000'H.

References: [MULPIv3.1] Service Flow Attribute Aggregation Mask section in the Common Radio Frequency Interface Encodings Annex.

#### 7.2.1.6.2.28 Appld

This attribute represents the Application Identifier associated with the service flow for purposes beyond the scope of this specification.

If the referenced parameter is not present in the corresponding DOCSIS QoS Parameter Set, this attribute returns 0.

References: [MULPIv3.1] Application Identifier section in the Common Radio Frequency Interface Encodings Annex.

#### 7.2.1.6.2.29 MultiplierContentionReqWindow

This attribute specifies the multiplier to be applied by a CM when performing contention request backoff for data requests. This attribute only applies to upstream Service Flows in 3.0 operation. If the referenced parameter is not present in the upstream DOCSIS QoS Parameter Set, or is not applicable, this attribute returns 8.

References: [MULPIv3.1] Multiplier to Contention Request Backoff Window section in the Common Radio Frequency Interface Encodings Annex.

#### 7.2.1.6.2.30 MultiplierBytesReq

This attribute specifies the assumed bandwidth request multiplier. This attribute only applies to upstream Service Flows in 3.0 operation. If the referenced parameter is not present in the upstream DOCSIS QoS Parameter Set, or is not applicable, this attribute returns 4.

References: [MULPIv3.1] Multiplier to Number of Bytes Requested section in the Common Radio Frequency Interface Encodings Annex.

#### 7.2.1.6.2.31 MaxReqPerSidCluster

This attribute specifies the maximum number of requests that a CM can make within a given SID Cluster before it needs to switch to a different SID Cluster to make further requests. A value of 0 indicates there is no limit. This attribute only applies to upstream Service Flows in 3.0 operation, in other cases it is reported as 0. If the referenced parameter is not present in the DOCSIS QoS Parameter Set, this attribute returns 0.

This attribute has been deprecated and replaced with MaxReqPerSidCluster in the ServiceFlow object.

References: [MULPIv3.1] Maximum Requests per SID Cluster section in the Common Radio Frequency Interface Encodings Annex.

#### 7.2.1.6.2.32 MaxOutstandingBytesPerSidCluster

This attribute specifies the maximum number of bytes for which a CM can have requests outstanding on a given SID Cluster. If defined number of bytes are outstanding and further requests are required, the CM needs to switch to a different SID Cluster if one is available. A value of 0 indicates there is no limit. This attribute only applies to upstream Service Flows in 3.0 operation, in other cases it is reported as 0. If the referenced parameter is not present in the DOCSIS QoS Parameter Set, this attribute returns 0.

This attribute has been deprecated and replaced with MaxOutstandingBytesPerSidCluster in the ServiceFlow object.

References: [MULPIv3.1] Maximum Outstanding Bytes per SID Cluster section in the Common Radio Frequency Interface Encodings Annex.

#### 7.2.1.6.2.33 MaxTotBytesReqPerSidCluster

This attribute specifies the maximum total number of bytes a CM can have requested using a given SID Cluster before it needs to switch to a different SID Cluster to make further requests. A value of 0 indicates there is no limit. This attribute only applies to upstream Service Flows in 3.0 operation, in other cases it is reported as 0. If the referenced parameter is not present in the DOCSIS QoS Parameter Set, this attribute returns 0.

This attribute has been deprecated and replaced with MaxTotBytesReqPerSidCluster in the ServiceFlow object.

References: [MULPIv3.1] Maximum Total Bytes Requested per SID Cluster section in the Common Radio Frequency Interface Encodings Annex.

#### 7.2.1.6.2.34 MaxTimeInSidCluster

This attribute specifies the maximum time in milliseconds that a CM may use a particular SID Cluster before it has to switch to a different SID Cluster to make further requests. A value of 0 indicates there is no limit. This attribute only applies to upstream Service Flows in 3.0 operation, in other cases it is reported as 0. If the referenced parameter is not present in the DOCSIS QoS Parameter Set, this attribute returns 0.

This attribute has been deprecated and replaced with MaxTimeInSidCluster in the ServiceFlow object.

References: [MULPIv3.1] Maximum Time in the SID Cluster section in the Common Radio Frequency Interface Encodings Annex.

#### 7.2.1.6.2.35 PeakTrafficRate<sup>93</sup>

This attribute specifies the rate parameter 'P' of a token-bucket-based peak rate limiter for packets of a service flow. A value of 0 signifies no Peak Traffic Rate is enforced. If the referenced parameter is not present in the corresponding DOCSIS QoS Parameter Set, this attribute returns 0. This attribute will also return 0 if DataRateUnitSetting is enabled and the resulting value cannot be represented in 32 bits, in which case HCPeakTrafficRate should be utilized.

References: [MULPIv3.1] Peak Traffic Rate section in the Common Radio Frequency Interface Encodings Annex.

#### 7.2.1.6.2.36 DsResequencing

This attribute specifies if a resequencing DSID needs to be allocated to the service flow.

The value 'notApplicable' indicates the value of this attribute is not applicable.

The value 'resequencingDsid' indicates that a resequencing DSID is required if the service flow is assigned to a downstream bonding group

The value 'noResequencingDsid' indicates no resequencing DSID is associated with the service flow.

This attribute only applies to downstream Service Flows in 3.0 operation. If the referenced parameter is not present in the corresponding downstream DOCSIS QoS Parameter Set, this attribute returns 'notApplicable'. This parameter is not applicable to upstream DOCSIS QoS Parameter Sets, so the value 'notApplicable' is reported in that case.

References: [MULPIv3.1] Downstream Resequencing section in the Common Radio Frequency Interface Encodings Annex.

#### 7.2.1.6.2.37 MinimumBuffer

This attribute represents the configured minimum buffer size for the service flow.

References: [MULPIv3.1] Buffer Control section in the Common Radio Frequency Interface Encodings Annex.

#### 7.2.1.6.2.38 TargetBuffer

This attribute represents the configured target buffer size for the service flow. The value 0 indicates that no target buffer size was configured, and the device will use a vendor specific value.

References: [MULPIv3.1] Buffer Control section in the Common Radio Frequency Interface Encodings Annex.

#### 7.2.1.6.2.39 MaximumBuffer

This attribute represents the configured maximum buffer size for the service flow. The value 4294967295 indicates that no maximum buffer size was configured, and thus there is no limit to the buffer size.

References: [MULPIv3.1] Buffer Control section in the Common Radio Frequency Interface Encodings Annex.

#### 7.2.1.6.2.40 AqmDisabled<sup>94</sup>

If this attribute is set to 'true', AQM is disabled on the upstream or downstream service flow specified by ServiceFlowId.

References: [MULPIv3.1] AQM Encodings section in the Common Radio Frequency Interface Encodings Annex.

#### 7.2.1.6.2.41 AqmLatencyTarget<sup>95</sup>

This attribute provides the latency target to be used for the AQM algorithm for the upstream or downstream Service Flow specified by ServiceFlowId. For downstream service flows, the value 256 indicates an unknown latency target. The units are in milliseconds.

---

<sup>93</sup> Modified per CCAP-OSSiv3.1-N-16.1455-2 on 5/13/16 by KB.

<sup>94</sup> Added per CCAP-OSSiv3.1-N-16.1455-2 on 5/13/16 by KB.

<sup>95</sup> Added per CCAP-OSSiv3.1-N-16.1455-2 on 5/13/16 by KB.

References: [MULPIv3.1] AQM Encodings section in the Common Radio Frequency Interface Encodings Annex.

7.2.1.6.2.42 AqmAlgnUse<sup>96</sup>

This attribute specifies the AQM algorithm in use for this service flow. If AQM is disabled on the service flow specified by ServiceFlowId, this attribute returns unknown(1).

The value unknown(1) is reported for downstream service flows or when AQM is disabled.

The value other(2) indicates a vendor proprietary algorithm for upstream queue management.

The value docsisPIE(3) indicates the upstream queue management Proportional Integral controller Enhanced (PIE) algorithm.

References: [MULPIv3.1] Proportional-Integral-Enhanced Active Queue Management Algorithm Annex.

7.2.1.6.2.43 HCMaxTrafficRate<sup>97</sup>

This attribute is a 64-bit representation of the maximum sustained traffic rate allowed for this Service Flow in bits/sec. It represents all MAC frame data PDUs from the bytes following the MAC header HCS to the end of the CRC. The number of bytes forwarded is limited during any time interval. The value 0 means no maximum traffic rate is enforced. This attribute applies to both upstream and downstream Service Flows. This attribute returns 0 if the referenced parameter is not present in the corresponding DOCSIS QoS Parameter Set, or if the parameter is not applicable.

References: [MULPIv3.1] Maximum Sustained Traffic Rate section in the Common Radio Frequency Interface Encodings Annex.

7.2.1.6.2.44 HCMinReservedRate<sup>98</sup>

This attribute is a 64-bit representation of the guaranteed minimum rate in bits/sec for this parameter set. The value is calculated from the byte following the MAC header HCS to the end of the CRC. The value of 0 indicates that no bandwidth is reserved. If the referenced parameter is not present in the corresponding DOCSIS QoS Parameter Set, this attribute returns 0. If the parameter is not applicable, it is reported as 0.

References: [MULPIv3.1] Minimum Reserved Traffic Rate section of the Common Radio Frequency Interface Encodings Annex.

7.2.1.6.2.45 HCPeakTrafficRate<sup>99</sup>

This attribute is a 64-bit representation of the rate parameter 'P' of a token-bucket-based peak rate limiter for packets of a service flow. A value of 0 signifies no Peak Traffic Rate is enforced. If the referenced parameter is not present in the corresponding DOCSIS QoS Parameter Set, this attribute returns 0.

References: [MULPIv3.1] Peak Traffic Rate section in the Common Radio Frequency Interface Encodings Annex.

7.2.1.6.3 ServiceFlow Object

This object describes the set of DOCSIS-QoS Service Flows in a managed device.

References: [MULPIv3.1] Service Flows and Classifiers section.

**Table 7-34 - ServiceFlow Object<sup>100</sup>**

Attribute Name	Type	Access	Type Constraints	Units	Default
ifIndex	InterfaceIndex	key	Interface Index of MAC Domain interface	N/A	N/A

<sup>96</sup> Added per CCAP-OSSv3.1-N-16.1455-2 on 5/13/16 by KB.

<sup>97</sup> Added per CCAP-OSSv3.1-N-16.1455-2 on 5/13/16 by KB.

<sup>98</sup> Added per CCAP-OSSv3.1-N-16.1455-2 on 5/13/16 by KB.

<sup>99</sup> Added per CCAP-OSSv3.1-N-16.1455-2 on 5/13/16 by KB.

<sup>100</sup> Modified per CCAP-OSSv3.1-N-16.1528-2 on 11/15/16 by KB.



Attribute Name	Type	Access	Type Constraints	Units	Default
Id	unsignedInt	key		N/A	N/A
SID	unsignedShort	read-only		N/A	N/A
Direction	IfDirection	read-only		N/A	N/A
Primary	boolean	read-only		N/A	N/A
ParamSetTypeStatus	EnumBits	read-only	active(0) admitted(1) provisioned(2)	N/A	N/A
ChSetId	ChSetId	read-only		N/A	N/A
AttrAssignSuccess	boolean	read-only		N/A	N/A
Dsid	Dsid	read-only		N/A	N/A
MaxReqPerSidCluster	unsignedByte	read-only		requests	N/A
MaxOutstandingBytesPerSidCluster	unsignedInt	read-only		bytes	N/A
MaxTotBytesReqPerSidCluster	unsignedInt	read-only		bytes	N/A
MaxTimeInSidCluster	unsignedShort	read-only		milliseconds	N/A
BufferSize	unsignedInt	read-only		bytes	N/A
IatcProfileName	AdminString	read-only		N/A	N/A

#### 7.2.1.6.3.1 ifIndex

This key represents the interface index of the MAC Domain of the Service Flow.

#### 7.2.1.6.3.2 Id

This key represents an identifier assigned to a Service Flow by CMTS within a MAC Domain. The value 0 is used only for the purpose of reporting instances of the PktClass object pertaining UDCs and not used for association of QoS classifiers to service flows.

References: [MULPIv3.1] Service Flow Identifier section in the Common Radio Frequency Interface Encodings Annex.

#### 7.2.1.6.3.3 SID

Service Identifier (SID) assigned to an admitted or active Service Flow. This attribute reports a value of 0 if a Service ID is not associated with the Service Flow. Only active or admitted upstream Service Flows will have a Service ID (SID).

References: [MULPIv3.1] Service Identifier section in the Common Radio Frequency Interface Encodings Annex.

#### 7.2.1.6.3.4 Direction

This attribute represents the direction of the Service Flow.

#### 7.2.1.6.3.5 Primary

This attribute reflects whether Service Flow is the primary or a secondary Service Flow.

#### 7.2.1.6.3.6 ParamSetTypeStatus

This attribute represents the status of the service flow based on the admission state. 'active' bit set to '1' indicates that the service flow is active and that the corresponding QoS ParamSet is stored in the CMTS. 'admitted' bit set to '1' indicates that the service flow resources were reserved and that the corresponding QoS ParamSet is stored in the CMTS. 'provisioned' bit set to '1' indicates that the service flow was defined in the CM config file and that the corresponding QoS ParamSet is stored in the CMTS.

References: [MULPIv3.1] Service Flow section.

#### 7.2.1.6.3.7 ChSetId

This attribute represents the Channel Set Id associated with the service flow.

#### 7.2.1.6.3.8 AttrAssignSuccess

If set to 'true', this attribute indicates that the current channel set associated with the service flow meets the Required and Forbidden Attribute Mask encodings. Since this attribute is not applicable for a CM, the CM always returns 'false'.

References: [MULPIv3.1] Service Flow section.

#### 7.2.1.6.3.9 Dsid

This attribute indicates the DSID associated with the downstream service flow. downstream service flows without a DSID or upstream Service Flows report the value zero.

#### 7.2.1.6.3.10 MaxReqPerSidCluster

This attribute specifies the maximum number of requests that a CM can make within a given SID Cluster before it has to switch to a different SID Cluster to make further requests. A value of 0 indicates there is no limit. This attribute only applies to upstream Service Flows in 3.0 operation, in other cases it is reported as 0.

References: [MULPIv3.1] Maximum Requests per SID Cluster section in the Common Radio Frequency Interface Encodings Annex.

#### 7.2.1.6.3.11 MaxOutstandingBytesPerSidCluster

This attribute specifies the maximum number of bytes for which a CM can have requests outstanding on a given SID Cluster. If defined number of bytes are outstanding and further requests are required, the CM needs to switch to a different SID Cluster if one is available. A value of 0 indicates there is no limit. This attribute only applies to upstream Service Flows in 3.0 operation, in other cases it is reported as 0.

References: [MULPIv3.1] Maximum Outstanding Bytes per SID Cluster section in the Common Radio Frequency Interface Encodings Annex.

#### 7.2.1.6.3.12 MaxTotBytesReqPerSidCluster

This attribute specifies the maximum total number of bytes a CM can have requested using a given SID Cluster before it has to switch to a different SID Cluster to make further requests. A value of 0 indicates there is no limit. This attribute only applies to upstream Service Flows in 3.0 operation, in other cases it is reported as 0.

References: [MULPIv3.1] Maximum Total Bytes Requested per SID Cluster section in the Common Radio Frequency Interface Encodings Annex.

#### 7.2.1.6.3.13 MaxTimeInSidCluster

This attribute specifies the maximum time in milliseconds that a CM may use a particular SID Cluster before it has to switch to a different SID Cluster to make further requests. A value of 0 indicates there is no limit. This attribute only applies to upstream Service Flows in 3.0 operation, in other cases it is reported as 0.

References: [MULPIv3.1] Maximum Time in the SID Cluster section in the Common Radio Frequency Interface Encodings Annex.

#### 7.2.1.6.3.14 BufferSize

This attribute indicates the buffer size for the service flow. For the CM this attribute only applies to upstream Service Flows, for the CMTS this attribute only applies to downstream Service Flows, in other cases it is reported as 0.

References: [MULPIv3.1] Buffer Control section in the Common Radio Frequency Interface Encodings Annex.

7.2.1.6.3.15 IatcProfileName<sup>101</sup>

This attribute indicates the name of the IATC Profile to which this Service Flow belongs. If this Service Flow is not part of an IATC Profile, this attribute returns an empty string.

## 7.2.1.6.4 CmtsMacToSrvFlow

This object provides the mapping of unicast service flows with the cable modem the service flows belongs to.

**Table 7-35 - CmtsMacToSrvFlow Object**

Attribute Name	Type	Access	Type Constraints	Units	Default
CmMac	MacAddress	key		N/A	N/A
ServiceFlowId	unsignedInt	key		N/A	N/A
IfIndex	InterfaceIndex	read-only	Interface Index of MAC Domain interface	N/A	N/A

## 7.2.1.6.4.1 CmMac

This key represents the MAC address for the referenced CM.

## 7.2.1.6.4.2 ServiceFlowId

This key represents the identifier of the Service Flow.

## 7.2.1.6.4.3 IfIndex

This attribute represents the interface index of the MAC domain of the Service Flow and where the Cable Modem is registered.

## 7.2.1.6.5 ServiceFlowSidCluster Object

This object defines the SID clusters associated with an upstream service flow.

References: [MULPIv3.1] Service Flow SID Cluster Assignments section in the Common Radio Frequency Interface Encodings Annex.

**Table 7-36 - ServiceFlowSidCluster Object**

Attribute Name	Type	Access	Type Constraints	Units	Default
IfIndex	InterfaceIndex	Key	Interface Index of MAC Domain interface	N/A	N/A
ServiceFlowId	unsignedInt	Key	1.. 4294967295	N/A	N/A
Id	unsignedByte	Key	0..7	N/A	N/A
Ucid	ChId	Key	1..255	N/A	N/A
Sid	unsignedInt	Read-only	1..16383	N/A	N/A

## 7.2.1.6.5.1 IfIndex

This key represents the interface index of the MAC Domain of the Service Flow SID cluster.

## 7.2.1.6.5.2 ServiceFlowId

This key represents the Service Flow ID for the service flow.

## 7.2.1.6.5.3 Id

This key represents the identifier of the SID Cluster.

References: [MULPIv3.1] SID Cluster ID section in the Common Radio Frequency Interface Encodings Annex.

<sup>101</sup> Added per CCAP-OSSiv3.1-N-16.1528-2 on 11/15/16 by KB.

#### 7.2.1.6.5.4 Ucid

This key represents the upstream Channel ID mapped to the corresponding SID.

#### 7.2.1.6.5.5 Sid

This attribute represents the SID assigned to the upstream channel in this SID Cluster.

#### 7.2.1.6.6 GrpServiceFlow Object<sup>102</sup>

This object provides extensions to the service flow information for Group Service Flows (GSFs).

References: [MULPIv3.1] QoS Support for Joined IP Multicast Traffic section.

**Table 7-37 - GrpServiceFlow Object**

Attribute Name	Type	Access	Type Constraints	Units	Default
ifIndex	InterfaceIndex	key	Interface Index of MAC Domain interface	N/A	N/A
ServiceFlowId	unsignedInt	key	1.. 4294967295	N/A	N/A
IsDef	boolean	read-only		N/A	N/A
QosCfgId	unsignedShort	read-only		N/A	N/A
NumSess	unsignedShort	read-only	1..65535	sessions	N/A
SrcAddr	InetAddress	read-only		N/A	N/A
GrpAddr	InetAddress	read-only		N/A	N/A

#### 7.2.1.6.6.1 ifIndex

This key represents the interface index of the MAC Domain of the Group Service Flow.

#### 7.2.1.6.6.2 ServiceFlowId

This key represents the Service Flow ID for the Service Flow.

References: [MULPIv3.1] QoS section.

#### 7.2.1.6.6.3 IsDef

This attribute indicates whether the GSF QoS Parameter Set corresponds to the Default Group Service Flow.

References: [OSSlv3.0] Annex M.

#### 7.2.1.6.6.4 QosCfgId

This attribute indicates the Group QoS Configuration (GQC) identifier used of the creation of this GSF. The value zero indicates that the service flow is using the default service flow policy.

References: [OSSlv3.0] Annex M.

#### 7.2.1.6.6.5 NumSess

This attribute indicates the number of sessions that are configured in an aggregated Service Flow. If this is a single session replication, the value of this attribute is 1.

References: [OSSlv3.0] Annex M.

#### 7.2.1.6.6.6 SrcAddr

This attribute indicates the specific multicast Source Address that is configured in a single session Service Flow. If this is an aggregate Service Flow (NumSess attribute reports a value greater than 1), this attribute returns one of the

<sup>102</sup> Section and subsections modified per CCAP-OSSlv3.1-N-15.1307-3 on 6/1/15 by KB.

multicast source addresses for the session. For the case of Any Source Multicast (ASM), this attribute reports a value of 0.0.0.0 for IPv4 or 0::0 for IPv6.

#### 7.2.1.6.6.7 GrpAddr

This attribute indicates the specific Multicast Group Address that is configured in a single session Service Flow. If this is an aggregate Service Flow (NumSess attribute reports a value greater than 1), this attribute returns the multicast group address associated with the SrcAddr for the session.

#### 7.2.1.6.7 GrpPktClass Object

This object provides additional packet classification information for Group Classifier References (GCRs) in a Group Service Flow (GSF).

References: [MULPIv3.1] QoS Support for Joined IP Multicast Traffic section.

**Table 7-38 - GrpPktClass Object**

Attribute Name	Type	Access	Type Constraints	Units	Default
IfIndex	InterfaceIndex	key	Interface Index of MAC Domain interface	N/A	N/A
ServiceFlowId	unsignedInt	key	1..4294967295	N/A	N/A
PktClassId	unsignedShort	key	1..65535	N/A	N/A
GrpCfgId	unsignedInt	read-only	1..4294967295	N/A	N/A

##### 7.2.1.6.7.1 IfIndex

This key represents the interface index of the MAC Domain to which this instance applies.

##### 7.2.1.6.7.2 ServiceFlowId

This key represents the Service Flow ID of the service flow.

References: [MULPIv3.1] QoS section.

##### 7.2.1.6.7.3 PktClassId

This key represents the Classifier ID of a GCR associated with a GSF.

References: [MULPIv3.1] QoS section.

##### 7.2.1.6.7.4 GrpCfgId

This attribute indicates the GC identifier used of the creation of this GSF.

References: [OSSiv3.0] Annex M.

#### 7.2.1.6.8 CmtsDsid Object

This object describes DSID information stored in the CMTS.

The CMTS reports the current status of existing DSIDs. When a DSID is created during the registration process or a DBC transaction, a corresponding object instance is created. If a DSID is deleted or changed via a DBC message the corresponding object instance is deleted or updated respectively.

**Table 7-39 - CmtsDsid Object<sup>103</sup>**

Attribute Name	Type	Access	Type Constraints	Units	Default
IfIndex	InterfaceIndex	key	Interface Index of MAC Domain interface	N/A	N/A
Dsid	Dsid	key		N/A	N/A

<sup>103</sup> Modified per CCAP-OSSiv3.1-N-16.1566-1 on 11/16/16 by KB.

Attribute Name	Type	Access	Type Constraints	Units	Default
Usage	EnumBits	read-only	resequencing(0) multicastCapable(1) multicastReplication(2) bonding(3)	N/A	N/A
DsChSet	ChSetId	read-only		N/A	N/A
ReseqWaitTime	unsignedByte	read-only	0   1..180	hundredMicroseconds	N/A
ReseqWarnThrshld	unsignedByte	read-only	0..179	hundredMicroseconds	N/A
StatusHldoffTimerSeqOutOfRng	unsignedShort	read-only		20 milliseconds	N/A
CurrentSeqNum	unsignedShort	read-only		N/A	N/A

#### 7.2.1.6.8.1 IfIndex

This key represents the interface index of the MAC Domain associated with the DSID.

#### 7.2.1.6.8.2 Dsid

This key represents the DSID.

#### 7.2.1.6.8.3 Usage

This attribute indicates the properties of the DSID. The bits are defined as follows:

- 'resequencing'

This bit is set to 1 for a Resequencing DSID.

- 'multicastCapable'

This bit is set to 1 for a DSID that is capable of transporting multicast traffic (i.e., the DSID has multicast forwarding attributes).

- 'multicastReplication'

This bit is set to 1 for a DSID that is used for transporting a multicast replication (i.e., there is a corresponding instance of the CmtsReplSess object).

- 'bonding'

This bit is set to a 1 for a DSID that is associated with a bonding group.

References: [OSSv3.0] Annex M; [MULPIv3.1] DSID Encodings section in the Common Radio Frequency Interface Encodings Annex.

#### 7.2.1.6.8.4 DsChSet

This attribute represents the Downstream Channel Set over which the DSID is being resequenced.

#### 7.2.1.6.8.5 ReseqWaitTime

This attribute represents the DSID Resequencing Wait Time that is used for this DSID. This attribute is only valid when the Usage attribute has the resequencing bit set to 1. This attribute returns a value of 0 when the Usage attribute has the resequencing bit set to 0.

#### 7.2.1.6.8.6 ReseqWarnThrshld

This attribute represents the DSID Resequencing Warning Threshold that is used for this DSID. The value of 0 indicates that the threshold warnings are disabled. This attribute is only valid when the Usage attribute has the

resequencing bit set to 1. This attribute returns a value of 0 when the Usage attribute has the resequencing bit set to 0.

#### 7.2.1.6.8.7 StatusHldoffTimerSeqOutOfRng

This attribute represents the hold-off timer for reporting Out-of-Range Events via the CM-STATUS MAC Management message. This attribute is only valid when the Usage attribute has the resequencing bit set to 1. This attribute returns a value of 0 when the Usage attribute has the resequencing bit set to 0.

#### 7.2.1.6.8.8 LastSeqNum

This attribute reports the value of the most recent sequence number assigned by the CMTS for this DSID. This attribute is only valid when the Usage attribute has the resequencing bit set to 1. This attribute returns a value of 0 when the Usage attribute has the resequencing bit set to 0.

#### 7.2.1.6.9 IP Multicast QoS Event Behaviors<sup>104</sup>

This section defines the behavior and trigger mechanisms for several of the Multicast QoS event definitions defined in Annex D.

Event ID 89010104 reflects that a particular Group Service Flow is dropping packets as a result of a) the incoming data rate exceeding the rate-shaping bounds defined by the combination of Maximum Sustained Traffic Rate, Maximum Traffic Burst, and Peak Traffic Rate in the Group QoS Configuration, or b) the available capacity of the DCS is insufficient to support forwarding. When event reporting is administratively enabled, the CMTS MUST generate event ID 89010104 when the condition of packet loss is detected. The CMTS SHOULD detect this condition when packet loss due to AQM or buffer overflow exceeds one packet per second for each of the most recent three seconds.

Event ID 89010105 reflects that a particular Group Service Flow is no longer dropping packets as a result of a) the incoming data rate exceeding the rate-shaping bounds defined by the combination of Maximum Sustained Traffic Rate, Maximum Traffic Burst, and Peak Traffic Rate in the Group QoS Configuration, or b) the available capacity of the DCS is insufficient to support forwarding. When event reporting is administratively enabled, the CMTS MUST generate Event ID 89010105 when the condition of packet loss is no longer detected. Once a particular multicast session is in a "dropping packets" state (as indicated by the generation of event ID 89010104), the CMTS SHOULD detect this condition when packet loss due to AQM or buffer overflow equals zero packets per second for each of the most recent three seconds.

Admitted Multicast Aggregate Bandwidth is defined as the sum of the Minimum Reserved Traffic Rates of each Group Service Flow that has been admitted on a given CMTS cable interface. Note that for some vendors this CMTS cable interface will be a cable-mac interface. For others, it will be a DOCSIS Downstream Channel Set. In either case, this CMTS cable interface exists as a row entry in the ifTable (and therefore has an ifIndex which can be referenced in the defined event messages).

The IGMP and MLD protocol event messages include a threshold for determining whether ingress packet loss is occurring for IGMP/MLD protocol messages received from clients. For the IGMP/MLD protocol packet loss Event IDs 89010106 through 89010111, the configuration and logic to determine how a threshold crossing is calculated for the high and low thresholds is vendor-specific.

---

<sup>104</sup> Added per CCAP-OSSiv3.1-N-15.1307-3 on 6/1/15 by KB.

### 7.2.1.7 DOCS-SEC-MIB

The objects in the DOCS-SEC-MIB are taken from the DOCS-SEC-MIB specified in Annex Q of [OSSv3.0]; the DocsSecCmtsCertRevocationListStatus object only includes the read-only attributes. Otherwise, these objects are used without modification for the CCAP.

Reference: [OSSv3.0], [DOCS-SEC-MIB]

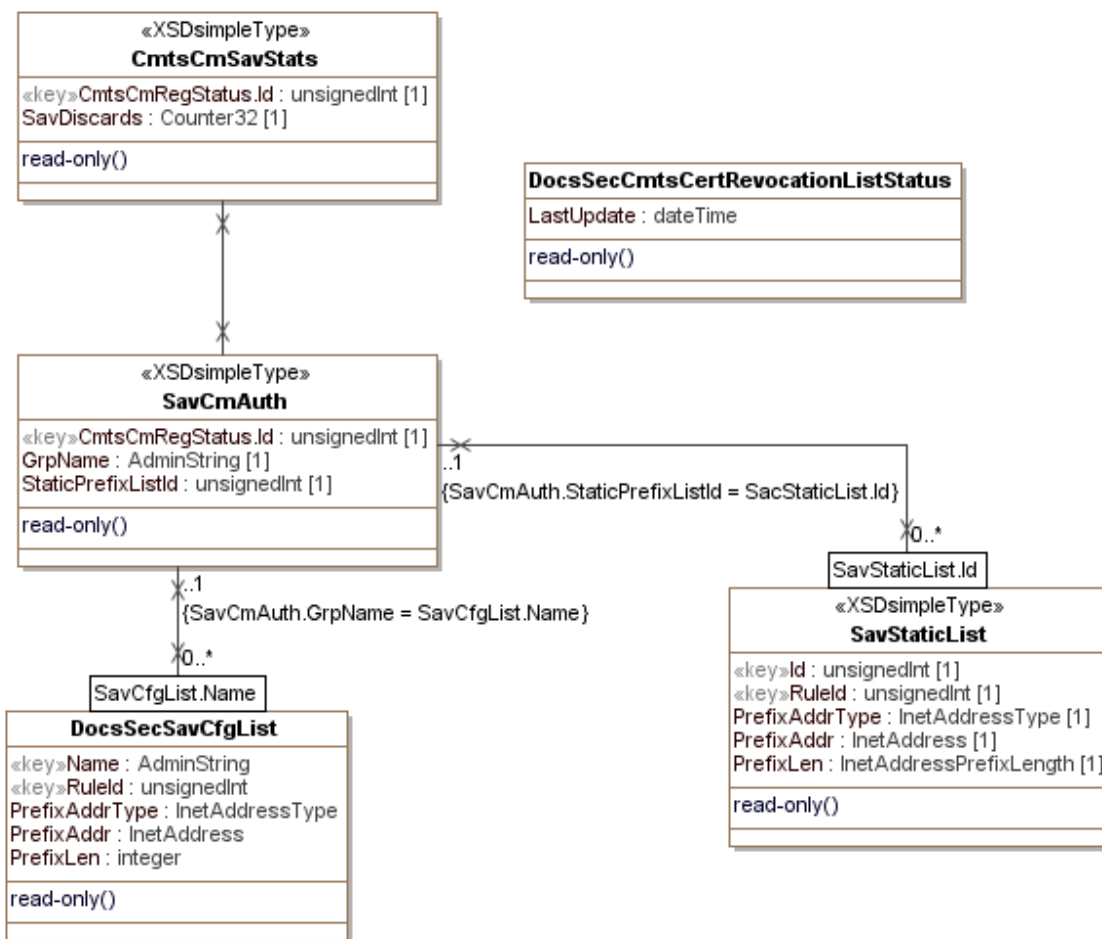

Figure 7-8 - DOCS-SEC-MIB Performance Management Objects

#### 7.2.1.7.1 SavCmAuth Object

This object defines a read-only set of SAV policies associated with a CM that the CMTS will use in addition to the CMTS verification of an operator assigned IP Address being associated with a CM. When the CMTS has not resolved a source address of a CM CPE, the CMTS verifies if the CM CPE is authorized to pass traffic based on this object. These object policies include a list of subnet prefixes (defined in the SavStaticList object) or a SAV Group Name that could reference a CMTS configured list of subnet prefixes (defined in SavCfgList object) or vendor-specific policies. The CMTS populates the attributes of this object for a CM from that CM's config file.

This object is only applicable when the SrcAddrVerificationEnabled attribute of the MdCfg object is 'true' and the CmAuthEnable attribute of the CmtsSavCtrl object is 'true'.

The CMTS is not required to persist instances of this object across reinitializations.



References: [OSSiv3.0] Annex O, MdCfg section; [SECv3.1] Secure Provisioning section; [MULPIv3.1] Common Radio Frequency Interface Encodings Annex.

**Table 7-40 - SavCmAuth Object**

Attribute Name	Type	Access	Type Constraints	Units	Default
CmtsCmRegStatusId	unsignedInt	key	1..4294967295	N/A	N/A
GrpName	AdminString	read-only		N/A	N/A
StaticPrefixListId	unsignedInt	read-only		N/A	N/A

#### 7.2.1.7.1.1 CmtsCmRegStatusId

This attribute is a key which uniquely identifies the CM. This attribute matches an index value of the CMTS CM Registration Status object.

References: [OSSiv3.0] Annex N, CmtsCmRegStatus section.

#### 7.2.1.7.1.2 GrpName

This attribute references the Name attribute of the SavCfgList object of a CM. If the CM signaled group name is not configured in the CMTS, the CMTS ignores this attribute value for the purpose of Source Address Verification. The CMTS MUST allow the modification of the GrpName object and use the updated SAV rules for newly discovered CPEs from CMs. When a source IP address is claimed by two CMs (e.g., detected as duplicated), the CMTS MUST use the current SAV rules defined for both CMs in case the SAV GrpName rules may have been updated. In the case of a persisting conflict, it is up to vendor-implementation to decide what CM should hold the SAV authorization.

The zero-length string indicates that no SAV Group was signaled by the CM. The zero-length value or a non-existing reference in the SavCfgList object means the SavCfgListName is ignored for the purpose of SAV.

References: [MULPIv3.1] Common Radio Frequency Interface Encodings Annex.

#### 7.2.1.7.1.3 StaticPrefixListId

This attribute identifies the reference to a CMTS created subnet prefix list based on the CM signaled static prefix list TLV elements. The CMTS may reuse this attribute value to reference more than one CM when those CMs have signaled the same subnet prefix list to the CMTS.

The value zero indicates that no SAV static prefix encodings were signaled by the CM.

#### 7.2.1.7.2 SavStaticList Object

This object defines a subnet prefix extension to the SavCmAuth object based on CM statically signaled subnet prefixes to the CMTS.

When a CM signals to the CMTS static subnet prefixes, the CMTS MUST create a List Id to be referenced by the CM in the SavCmAuth StaticPrefixListId attribute. When a CM signals to the CMTS static subnet prefixes, the CMTS MAY reference an existing List Id associated to previously registered CMs in case of those subnet prefixes associated with the List Id match the ones signaled by the CM.

The CMTS MAY persist instances of the SavStaticList object across reinitializations.

References: [MULPIv3.1] Common Radio Frequency Interface Encodings Annex.

**Table 7-41 - SavStaticList Object**

Attribute Name	Type	Access	Type Constraints	Units	Default
Id	unsignedInt	key	1..4294967295	N/A	N/A
RuleId	unsignedInt	key	1..4294967295	N/A	N/A
PrefixAddrType	InetAddressType	read-only	ipv4(1), ipv6(2)	N/A	N/A

Attribute Name	Type	Access	Type Constraints	Units	Default
PrefixAddr	InetAddress	read-only		N/A	N/A
PrefixLen	InetAddressPrefixLength	read-only		N/A	N/A

7.2.1.7.2.1 Id

This key uniquely identifies the index that groups multiple subnet prefix rules. The CMTS assigns this value per CM or may reuse it among multiple CMs that share the same list of subnet prefixes.

7.2.1.7.2.2 RuleId

This attribute is the key that identifies a particular static subnet prefix rule of an instance of this object.

7.2.1.7.2.3 PrefixAddrType

This attribute identifies the IP address type of this subnet prefix rule.

7.2.1.7.2.4 PrefixAddr

This attribute corresponds to the IP address of this subnet prefix rule in accordance to the PrefixAddrType attribute.

7.2.1.7.2.5 PrefixLen

This attribute defines the length of the subnet prefix to be matched by this rule.

7.2.1.7.3 CmtsCmSavStats Object

This object provides a read-only list of SAV counters for different service theft indications.

**Table 7-42 - CmtsCmSavStats Object**

Attribute Name	Type	Access	Type Constraints	Units	Default
CmtsCmRegStatusId	unsignedInt	key	1..4294967295	N/A	N/A
SavDiscards	Counter32	read-only		N/A	N/A

7.2.1.7.3.1 CmtsCmRegStatusId

This key uniquely identifies the CM. This attribute matches an index value of the CMTS CM Registration Status object.

References: [OSSlv3.0] Annex N, CmtsCmRegStatus section.

7.2.1.7.3.2 SavDiscards

This attribute provides the information about number of dropped upstream packets due to SAV failure.

7.2.1.7.4 CmtsCertRevocationListStatus Object

The LastUpdate attribute has been removed.

This object defines CCAP Certificate Revocation List status information.

This object is only applicable when the CertRevocationMethod attribute of the CmtsCertificate object is set to "crl" or "crlAndOcsp".

The CMTS and CCAP MUST persist the values of the Url and RefreshInterval attributes of the CmtsCertRevocationList object across reinitializations.

References: [SECV3.1] BPI+ X.509 Certificate Profile and Management section

**Table 7-43 - CmtsCertRevocationListStatus Object**

Attribute Name	Type	Access	Type Constraints	Units	Default
LastUpdate	dateTime	read-only		N/A	N/A

#### 7.2.1.7.4.1 LastUpdate

This attribute contains the last date and time when the CRL was retrieved by the CMTS. This attribute returns January 1, year 0000, 00:00:00.0 if the CRL has not been updated.

#### 7.2.1.8 DOCS-SUBMGT3-MIB

The DocsSubMgmt3FilterGrp object is taken from the CCAP Configuration UML model, described in Section 6.6.6.3.5, FilterGrp.

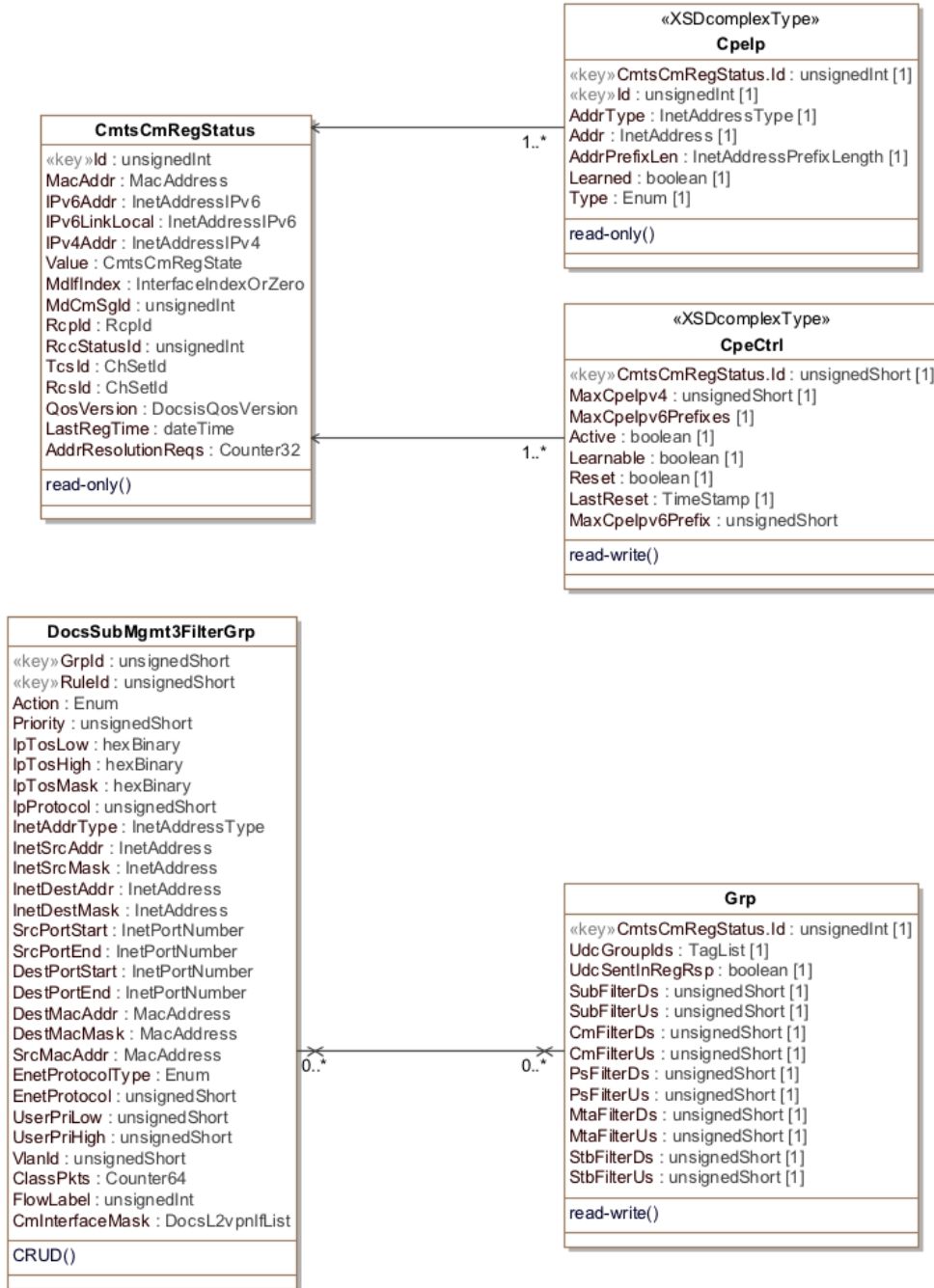

Figure 7-9 - DOCS-SUBMGT3-MIB Performance Management Objects<sup>105</sup>

<sup>105</sup> Figure caption corrected by CCAP-OSSlv3.1-N-1255-1 on 3/2/15 by KB. Figure revised per CCAP-OSSlv3.1-N-15.1321-1 on 7/20/15 by KB.

### 7.2.1.8.1 CpeCtrl<sup>106</sup>

This object maintains per-CM traffic policies enforced by the CMTS. The CMTS acquires the CM traffic policies through the CM registration process, or in the absence of some or all of those parameters, from the Base object. The CM information and controls are meaningful and used by the CMTS, but only after the CM is operational.

**Table 7-44 - CpeCtrl Object**

Attribute Name	Type	Access	Type Constraints	Units	Default
CmtsCmRegStatusId	unsignedShort	key	1..4294967295	N/A	N/A
MaxCpeIpv4	unsignedShort	read-write	0..1023	N/A	N/A
MaxCpeIpv6Prefixes	unsignedShort	read-write	0..1023	N/A	N/A
Active	boolean	read-write		N/A	N/A
Learnable	boolean	read-write		N/A	N/A
Reset	boolean	read-write		N/A	N/A
LastReset	TimeStamp	read-write		N/A	N/A

#### 7.2.1.8.1.1 CmtsCmRegStatusId

This key is the CMTS generated unique identifier of a CM for status report purposes.

#### 7.2.1.8.1.2 MaxCpeIpv4

This attribute represents the number of simultaneous IPv4 addresses permitted for CPEs connected to the CM. When the MaxCpeIpv4 attribute is set to zero (0), all IPv4 CPE traffic from the CM is dropped. The CMTS configures this attribute with whichever of the 'Subscriber Management CPE IPv4 List' or 'Subscriber Management Control-MaxCpeIPv4' signaled encodings is greater, or in the absence of all of those provisioning parameters, with the CpeMaxIpv4Def from the Base object. This limit applies to learned and DOCSIS-provisioned entries but not to entries added through some administrative process (e.g., statically) at the CMTS. Note that this attribute is only meaningful when the Active attribute of the CM is set to 'true'.

References: [MULPIv3.1] Subscriber Management TLVs section of the Common Radio Frequency Interface Encodings Annex.

#### 7.2.1.8.1.3 MaxCpeIpv6Prefixes

This attribute represents the maximum number of simultaneous IPv6 IA\_PD's (delegated prefixes) that are permitted for CPEs connected to the CM. When the MaxCpeIpv6Prefixes is set to zero (0), all IPv6 CPE traffic from the CM is dropped. The CMTS configures this attribute with whichever of the ('Subscriber Management CPE IPv6 List (TLV 67)' plus 'Subscriber Management CPE IPv6 Prefix List (TLV 61) ') or ('Subscriber Management Control Max CPE IPv6 Addresses (TLV 63)') signaled encodings is greater, or in the absence of all of those provisioning parameters, with the MaxIpv6PrefixesDef from the Base object. This limit applies to learned and DOCSIS-provisioned entries but not to entries added through some administrative process at the CMTS. Note that this attribute is only meaningful when the Active attribute of the CM is set to 'true'.

IPv6 IA\_PD's are counted against the CpeCtrlMaxCpeIpv6Prefixes in order to limit the number of simultaneous IA\_PD's permitted for the CM's CPEs.

References: [MULPIv3.1] Subscriber Management TLVs section of the Common Radio Frequency Interface Encodings Annex.

#### 7.2.1.8.1.4 Active

This attribute controls the application of subscriber management to this CM. If this is set to 'true', CMTS-based CPE control is active, and all the actions required by the various filter policies and controls apply at the CMTS. If this is set to false, no subscriber management filtering is done at the CMTS (but other filters may apply). If not set through DOCSIS provisioning, this object defaults to the value of the Active attribute of the Base object.

<sup>106</sup> Table and subsections revised per CCAP-OSSiv3.1-N-15.1321-1 on 7/20/15 by KB.

References: [MULPIv3.1] Subscriber Management TLVs section of the Common Radio Frequency Interface Encodings Annex.

7.2.1.8.1.5 Learnable

This attribute controls whether the CMTS may learn (and pass traffic for) CPE IP addresses associated with a CM. If this is set to 'true', the CMTS may learn up to the CM MaxCpeIp value less any DOCSIS-provisioned entries related to this CM. The nature of the learning mechanism is not specified here. If not set through DOCSIS provisioning, this object defaults to the value of the CpeLearnableDef attribute from the Base object. Note that this attribute is only meaningful if docsSubMgtCpeCtrlActive is 'true' to enforce a limit in the number of CPEs learned. CPE learning is always performed for the CMTS for security reasons.

References: [MULPIv3.1] Subscriber Management TLVs section of the Common Radio Frequency Interface Encodings Annex.

7.2.1.8.1.6 Reset

If set to 'true', this attribute commands the CMTS to delete the instances denoted as 'learned' addresses in the CpeIp object. This attribute always returns false on read.

7.2.1.8.1.7 LastReset

This attribute represents the system Up Time of the last set to 'true' of the Reset attribute of this instance. Zero if never reset.

7.2.1.8.2 Cpelp

This object defines the list of IP Addresses behind the CM known by the CMTS. If the Active attribute of the CpeCtrl object associated with a CM is set to 'true' and the CMTS receives an IP packet from a CM that contains a source IP address that does not match one of the CPE IP addresses associated with this CM, one of two things occurs. If the number of CPE IPs is less than the MaxCpeIp of the CpeCtrl object for that CM, the source IP address is added to this object and the packet is forwarded; otherwise, the packet is dropped.

**Table 7-45 - Cpelp Object**

Attribute Name	Type	Access	Type Constraints	Units	Default
CmtsCmRegStatusId	unsignedShort	key	1..4294967295	N/A	N/A
Id	unsignedInt	key	1..1023	N/A	N/A
AddrType	InetAddressType	read-only		N/A	N/A
Addr	InetAddress	read-only		N/A	N/A
AddrPrefixLen	InetAddressPrefixLength	read-only		N/A	N/A
Learned	boolean	read-only		N/A	N/A
Type	Enum	read-only	cpe(1) ps(2) mta(3) stb(4) tea(5) erouter(6)	N/A	N/A

7.2.1.8.2.1 CmtsCmRegStatusId

This key is the CMTS generated unique identifier of a CM for status reporting purposes.

7.2.1.8.2.2 Id

This attribute represents a unique identifier for a CPE IP of the CM. An instance of this attribute exists for each CPE provisioned in the 'Subscriber Management CPE IPv4 Table' or 'Subscriber Management CPE IPv6 Table' encodings. An entry is created either through the included CPE IP addresses in the provisioning object, or CPEs learned from traffic sourced from the CM.

References: [MULPIv3.1] Common Radio Frequency Interface Encodings Annex.

#### 7.2.1.8.2.3 AddrType<sup>107</sup>

The type of Internet address of the Addr attribute, such as IPv4 or IPv6.

#### 7.2.1.8.2.4 Addr<sup>108</sup>

This attribute represents the IP address either set from provisioning or learned via address gleaning of the DHCP exchange or some other means.

#### 7.2.1.8.2.5 AddrPrefixLen<sup>109</sup>

This attribute represents the prefix length associated with the IP prefix (IPv4 or IPv6) that is either set via provisioning or learned via address gleaning of the DHCP exchange or some other means. For IPv4 CPE addresses this attribute generally reports the value 32 (32 bits) to indicate a unicast IPv4 address. For IPv6 CPE addresses, this attribute represents either a discrete IPv6 IA\_NA unicast address (a value of 128 bits, equal to /128 prefix length) or an IA\_PD (delegated prefix) and its associated length (such as 56 bits, equal to /56 prefix length).

#### 7.2.1.8.2.6 Learned

This attribute is set to 'true' when the IP address was learned from IP packets sent upstream rather than via the CM provisioning process.

#### 7.2.1.8.2.7 Type

This attribute represents the type of CPE based on the following classifications: 'cpe' Regular CPE clients, 'ps' CableHome Portal Server (PS), 'mta' PacketCable Multimedia Terminal Adapter (MTA), 'stb' Digital Set-top Box (STB), 'tea' T1 Emulation adapter (TEA), 'erouter' Embedded Router (eRouter).

#### 7.2.1.8.3 Grp

This object defines the set of downstream and upstream filter groups that the CMTS applies to traffic associated with that CM.

References: [MULPIv3.1] Subscriber Management TLVs section in the Common Radio Frequency Interface Encodings Annex.

**Table 7-46 - Grp Object**

Attribute Name	Type	Access	Type Constraints	Units	Default
CmtsCmRegStatusId	unsignedShort	key	1..4294967295	N/A	N/A
UdcGroupIds	TagList	read-only		N/A	"H"
UdcSentInRegRsp	boolean	read-only		N/A	'false'
SubFilterDs	unsignedShort	read-write	0..1024	N/A	N/A
SubFilterUs	unsignedShort	read-write	0..1024	N/A	N/A
CmFilterDs	unsignedShort	read-write	0..1024	N/A	N/A
CmFilterUs	unsignedShort	read-write	0..1024	N/A	N/A
PsFilterDs	unsignedShort	read-write	0..1024	N/A	N/A
PsFilterUs	unsignedShort	read-write	0..1024	N/A	N/A
MtaFilterDs	unsignedShort	read-write	0..1024	N/A	N/A
MtaFilterUs	unsignedShort	read-write	0..1024	N/A	N/A
StbFilterDs	unsignedShort	read-write	0..1024	N/A	N/A
StbFilterUs	unsignedShort	read-write	0..1024	N/A	N/A

<sup>107</sup> Revised per CCAP-OSSiv3.1-N-15.1321-1 on 7/20/15 by KB.

<sup>108</sup> Revised per CCAP-OSSiv3.1-N-15.1321-1 on 7/20/15 by KB.

<sup>109</sup> Revised per CCAP-OSSiv3.1-N-15.1321-1 on 7/20/15 by KB.

#### 7.2.1.8.3.1 CmtsCmRegStatusId

This key is the CMTS generated unique identifier of a CM for status report purposes.

#### 7.2.1.8.3.2 UdcGroupIds

This attribute represents the filter group(s) associated with the CM signaled 'Upstream Drop Classifier Group ID' encodings during the registration process. UDC Group IDs are integer values and this attribute reports them as decimal numbers that are space-separated. The zero-length string indicates that the CM didn't signal UDC Group IDs.

This attribute provides two functions:

- Communicate the CM the configured UDC Group ID(s), irrespective of the CM being provisioned to filter upstream traffic based on IP Filters or UDCs.
- Optionally, and with regards to the CMTS, if the value of the attribute UdcSentInReqRsp is 'true', indicates that the filtering rules associated with the Subscriber Management Group ID(s) will be sent during registration to the CM. It is vendor specific whether the CMTS updates individual CM UDCs after registration when rules are changed in the Grp object.

#### 7.2.1.8.3.3 UdcSentInReqRsp

This attribute represents the CMTS upstream filtering status for this CM. The value 'true' indicates that the CMTS has sent UDCs to the CM during registration process. In order for a CMTS to send UDCs to a CM, the CMTS MAC Domain needs to be enabled via the MAC Domain attribute SendUdcRulesEnabled and the CM had indicated the UDC capability support during the registration process. The value 'false' indicates that the CMTS was not enabled to send UDCs to the CMs in the MAC Domain, or the CM did not advertise UDC support in its capabilities encodings, or both. Since the CMTS capability to send UDCs to CMs during the registration process is optional, the CMTS is not required to instantiate this attribute.

#### 7.2.1.8.3.4 SubFilterDs

This attribute represents the filter group applied to traffic destined for subscriber's CPE attached to the referenced CM (attached to CM CPE interfaces). This value corresponds to the 'Subscriber Downstream Group' value of the 'Subscriber Management Filter Groups' encoding signaled during the CM registration or in its absence, to the SubFilterDownDef attribute of the Base object. The value zero or a filter group ID not configured in the CMTS means no filtering is applied to traffic destined to hosts attached to this CM.

#### 7.2.1.8.3.5 SubFilterUs

This attribute represents the filter group applied to traffic originating from subscriber's CPE attached to the referenced CM (attached to CM CPE interfaces). This value corresponds to the 'Subscriber Upstream Group' value of the 'Subscriber Management Filter Groups' encoding signaled during the CM registration or in its absence, to the SubFilterUpDef attribute of the Base object. The value zero or a filter group ID not configured in the CMTS means no filtering is applied to traffic originating from hosts attached to this CM.

#### 7.2.1.8.3.6 CmFilterDs

This attribute represents the filter group applied to traffic destined for the CM itself. This value corresponds to the 'CM Downstream Group' value of the 'Subscriber Management Filter Groups' encoding signaled during the CM registration or in its absence, to the CmFilterDownDef attribute of the Base object. The value zero or a filter group ID not configured in the CMTS means no filtering is applied to traffic destined to this CM.

#### 7.2.1.8.3.7 CmFilterUs

This attribute represents the filter group applied to traffic originating from the CM itself. This value corresponds to the 'Subscriber Upstream Group' value of the 'Subscriber Management Filter Groups' encoding signaled during the CM registration or in its absence, to the SubFilterUpDef attribute of the Base object. The value zero or a filter group ID not configured in the CMTS means no filtering is applied to traffic originating from this CM.



#### 7.2.1.8.3.8 PsFilterDs

This attribute represents the filter group applied to traffic destined to the Embedded CableHome Portal Services Element or the Embedded Router on the referenced CM. This value corresponds to the 'PS Downstream Group' value of the 'Subscriber Management Filter Groups' encoding signaled during the CM registration or in its absence, to the SubFilterDownDef attribute of the Base object. The value zero or a filter group ID not configured in the CMTS means no filtering is applied to traffic destined to the Embedded CableHome Portal Services Element or Embedded Router on this CM.

#### 7.2.1.8.3.9 PsFilterUs

This attribute represents the filter group applied to traffic originating from the Embedded CableHome Portal Services Element or Embedded Router on the referenced CM. This value corresponds to the 'PS Upstream Group' value of the 'Subscriber Management Filter Groups' encoding signaled during the CM registration or in its absence, to the SubFilterUpDef attribute of the Base object. The value zero or a filter group ID not configured in the CMTS means no filtering is applied to traffic originating from the Embedded CableHome Portal Services Element or Embedded Router on this CM.

#### 7.2.1.8.3.10 MtaFilterDs

This attribute represents the filter group applied to traffic destined to the Embedded Multimedia Terminal Adapter on the referenced CM. This value corresponds to the 'MTA Downstream Group' value of the 'Subscriber Management Filter Groups' encoding signaled during the CM registration or in its absence, to the SubFilterDownDef attribute of the Base object. The value zero or a filter group ID not configured in the CMTS means no filtering is applied to traffic destined to the Embedded Multimedia Terminal Adapter on this CM.

#### 7.2.1.8.3.11 MtaFilterUs

This attribute represents the filter group applied to traffic originating from the Embedded Multimedia Terminal Adapter on the referenced CM. This value corresponds to the 'MTA Upstream Group' value of the 'Subscriber Management Filter Groups' encoding signaled during the CM registration or in its absence, to the SubFilterUpDef attribute of the Base object. The value zero or a filter group ID not configured in the CMTS means no filtering is applied to traffic originating from the Embedded Multimedia Terminal Adapter on this CM.

#### 7.2.1.8.3.12 StbFilterDs

This attribute represents the filter group applied to traffic destined for the Embedded Set-Top Box on the referenced CM. This value corresponds to the 'STB Downstream Group' value of the 'Subscriber Management Filter Groups' encoding signaled during the CM registration or in its absence, to the SubFilterDownDef attribute of the Base object. The value zero or a filter group ID not configured in the CMTS means no filtering is applied to traffic destined to the Embedded Set-Top Box on this CM.

#### 7.2.1.8.3.13 StbFilterUs

This attribute represents the filter group applied to traffic originating from the Embedded Set-Top Box on the referenced CM. This value corresponds to the 'STB Upstream Group' value of the 'Subscriber Management Filter Groups' encoding signaled during the CM registration or in its absence, to the SubFilterUpDef attribute of the Base object. The value zero or a filter group ID not configured in the CMTS means no filtering is applied to traffic originating from the Embedded Set-Top Box on this CM.

### 7.2.1.9 CCAP Topology Objects

The RfPortFnCfg object is taken from the CLAB-TOPO-MIB specified in Annex Q of [OSSiv3.0] and used without modification for the CCAP.

The FiberNodeCfg object is taken from the CCAP Configuration UML model; it is defined in Section 6.6.4.12 FiberNodeCfg.

Reference: [OSSiv3.0], [DOCS-IF3-MIB], [CLAB-TOPO-MIB]

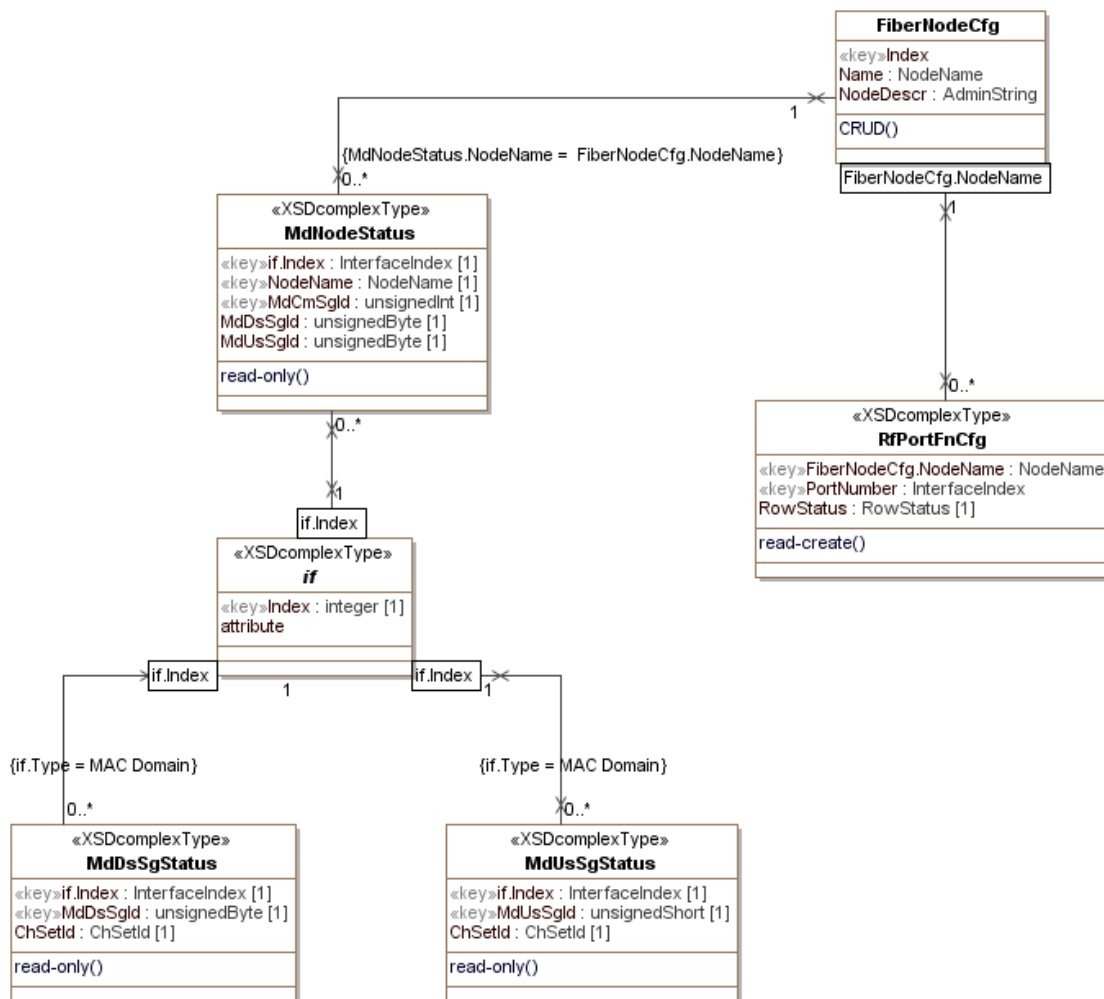

Figure 7-10 - CCAP Topology Performance Management Objects

7.2.1.9.1 MdNodeStatus

This object reports the MD-DS-SG-ID and MD-US-SG-ID associated with a MD-CM-SG-ID within a MAC Domain and the Fiber Nodes reached by the MD-CM-SG.

Table 7-47 - MdNodeStatus Object

Attribute Name	Type	Access	Type Constraints	Units
IfIndex	InterfaceIndex	key	InterfaceIndex of MAC Domain interface	N/A
NodeName	NodeName	key	SIZE (1..64)	N/A
MdCmSgld	unsignedInt	key	1..4294967295	N/A
MdDsSgld	unsignedByte	read-only	1..255	N/A
MsUsSgld	unsignedByte	read-only	1..255	N/A

7.2.1.9.1.1 IfIndex

This key represents the interface index of the MAC Domain associated with the fiber node to which this instance applies.

#### 7.2.1.9.1.2 NodeName

This key represents the name of a fiber node associated with a MD-CM-SG of a MAC Domain.

#### 7.2.1.9.1.3 MdCmSgld

This attribute is a key and indicates the MD-CM-SG-ID of this instance. A particular MdCmSgld in a MAC Domain is associated with one or more Fiber Nodes.

#### 7.2.1.9.1.4 MdDsSgld

This attribute corresponds to the MD-DS-SG-ID of the MD-CM-SG of this object instance. The MdDsSgld values are unique within a MAC Domain.

#### 7.2.1.9.1.5 MdUsSgld

This attribute corresponds to the MD-US-SG-ID of the MD-CM-SG of this object instance. The MdUsSgld values are unique within a MAC Domain.

#### 7.2.1.9.2 MdDsSgStatus

This object returns the list of downstream channel set associated with a MAC Domain MD-DS-SG-ID.

**Table 7-48 - MdDsSgStatus Object**

Attribute Name	Type	Access	Type Constraints	Units	Default
ifIndex	InterfaceIndex	key	InterfaceIndex of MAC Domain interface	N/A	N/A
MdDsSgld	unsignedByte	key	1..255	N/A	N/A
ChSetId	ChSetId	read-only		N/A	N/A

#### 7.2.1.9.2.1 IfIndex

This key represents the interface index of the MAC Domain to which the MD-DS-SG-ID applies.

#### 7.2.1.9.2.2 MdDsSgld

This key represents a MD-DS-SG-ID in a Mac Domain.

#### 7.2.1.9.2.3 ChSetId

This attribute represents a reference to the list of downstream channels of the MD-DS-SG-ID.

#### 7.2.1.9.3 MdUsSgStatus

This object returns the list of upstream channels associated with a MAC Domain MD-US-SG-ID.

**Table 7-49 - MdUsSgStatus Object**

Attribute Name	Type	Access	Type Constraints	Units
ifIndex	InterfaceIndex	key	InterfaceIndex of MAC Domain interface	N/A
MdUsSgld	unsignedByte	key	1..255	N/A
ChSetId	ChSetId	read-only		N/A

#### 7.2.1.9.3.1 IfIndex

This key represents the interface index of the MAC Domain to which the MD-DS-SG-ID applies.

#### 7.2.1.9.3.2 MdUsSgld

This key represents a MD-US-SG-ID in a Mac Domain.

7.2.1.9.3.3 ChSetId

This attribute represents a reference to the list of upstream channels of the MD-US-SG-ID.

7.2.1.10 CCAP-MIB

The CCAP-MIB defines the following:

- Objects that provide a link between an identifier of a CCAP interface used in the XML configuration file and its corresponding standard ifIndex MIB object from the ifTable and entPhysicalIndex MIB object from the ENTITY-MIB.
- Objects that can be used for video input program bitrate monitoring. Both the input program bitrate and input program requested bitrate can be accessed.
- Objects that can be used to determine the status of the ECMD and ECMG.

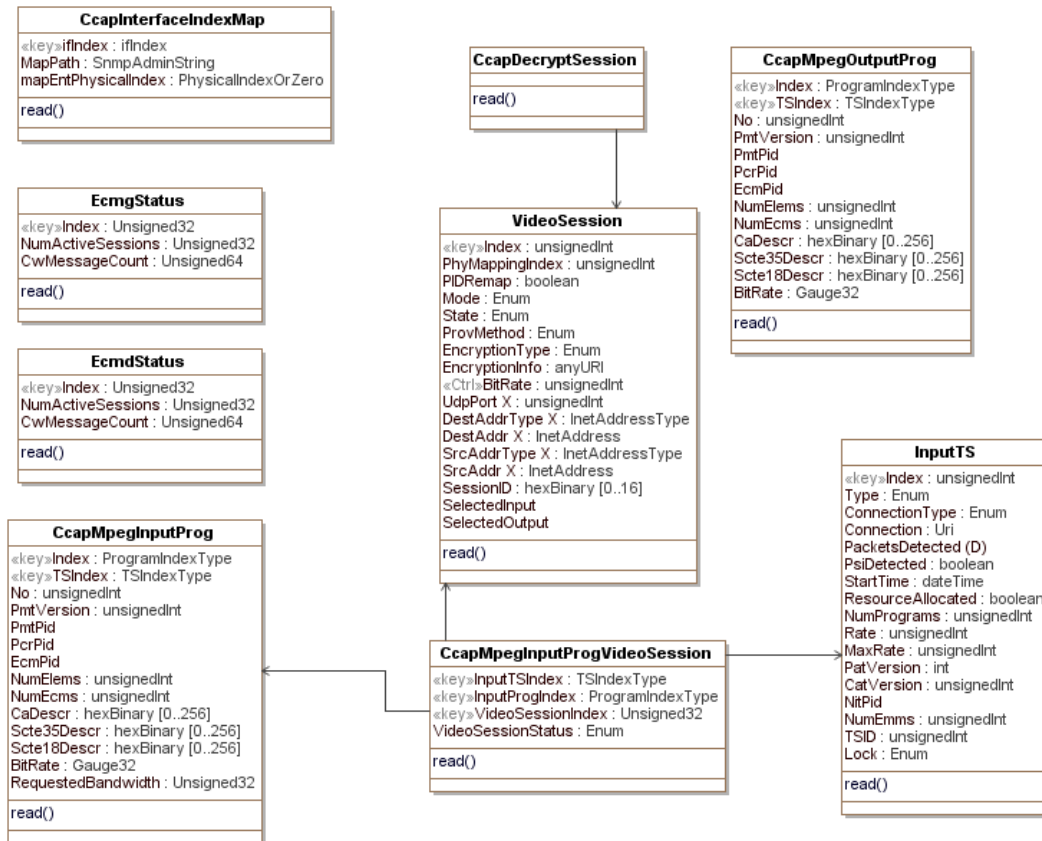

Figure 7-11 - CCAP-MIB Performance Management Objects

The objects that make up the CCAP-MIB are described in the following sections.

7.2.1.10.1 CcapInterfaceIndexMap

This object reports the corresponding device path for the Interface index defined by an object instance.

Table 7-50 - CcapInterfaceIndexMap Object Attributes

Attribute Name	Type	Access	Type Constraints	Units	Default Value
ifIndex	ifIndex	key			

Attribute Name	Type	Access	Type Constraints	Units	Default Value
MapPath	SnmpAdminString	read-only			
mapEntPhysicalIndex	PhysicalIndexOrZero	read-only			

### 7.2.1.10.1.1 CcapInterfaceIndexMap Attributes

#### 7.2.1.10.1.1.1 ifIndex

The index corresponds to the Interface MIB index for interfaces of IANA interface types:

- MAC Interface: docsCableMaclayer - 127
- Downstream Channel: docsCableDownstream - 128
- Upstream Interface: docsCableUpstream - 129
- Logical Upstream Channel: docsCableUpstreamChannel - 205
- Upstream RF Port: docsCableUpstreamRfPort - 256
- Downstream RF Port: cableDownstreamRfPort - 257

#### 7.2.1.10.1.1.2 MapPath

This attribute indicates the CCAP node XPath expression that identifies the resource associated with the interface index. For example, the path value of the resource associated with an upstream logical channel with index = 5, in upstream physical channel index = 7, in an Upstream RF port number = 15, from an US RF Line Card, in slot number = 3, chassis id = 1 is represented as:

```

/ccap/chassis[id="1"]
/slot[number="3"]
/rf-line-card
/us-rf-port[number="15"]
/upstream-physical-channel[index="7"]
/upstream-logical-channel[index="5"]

```

**NOTE:** Line breaks in this example were added for clarity.

#### 7.2.1.10.1.1.3 mapEntPhysicalIndex

This attribute corresponds to the entPhysicalIndex associated with the resource. The value is zero (0) if undefined.

### 7.2.1.10.2 EcmgStatus

This object allows for the monitoring of the interface to an Entitlement Control Message Generator (ECMG).

**Table 7-51 - EcmgStatus Object Attributes**

Attribute Name	Type	Access	Type Constraints	Units	Default Value
Index	UnsignedInt	Key			
NumActiveSessions	UnsignedInt	read-only			
CwMessageCount	UnsignedLong	read-only			

7.2.1.10.2.1 EcmgStatus Object Attributes

**7.2.1.10.2.1.1 Index**

This is an index for an instance of this object. It is a pointer to a defined Ecmg object.

**7.2.1.10.2.1.2 NumActiveSessions**

The current number of encryption sessions managed by the ECMG.

**7.2.1.10.2.1.3 CwMessageCount**

A running 64-bit counter that increments by one, every time the Encryptor receives one CW message from the ECMG. The counter is reset at boot time.

7.2.1.10.3 EcmdStatus

This object allows for the monitoring of the interface to an Entitlement Control Message Decoder (ECMD).

**Table 7-52 - EcmdStatus Object Attributes**

Attribute Name	Type	Access	Type Constraints	Units	Default Value
Index	UnsignedInt	Key			
NumActiveSessions	UnsignedInt	read-only			
CwMessageCount	UnsignedLong	read-only			

7.2.1.10.3.1 EcmdStatus Object Attributes

**7.2.1.10.3.1.1 EcmdIndex**

This is an index for an instance of this object. It is a pointer to a defined Ecmd object.

**7.2.1.10.3.1.2 NumActiveSessions**

The current number of decryption sessions managed by the ECMD.

**7.2.1.10.3.1.3 CwMessageCount**

A running 64-bit counter that increments by one, every time the Decryptor receives one CW message from the ECMD. The counter is reset at boot time.

7.2.1.10.4 CcapMpegInputProg

This object augments the mpegInputProgTable of the SCTE-HMS-MPEG-MIB with two additional attributes:

- BitRate
- RequestedBandwidth

No further modifications have been made to this table.

Reference: [SCTE 154-4]

**Table 7-53 - CcapMpegInputProg Object Attributes**

Attribute Name	Type	Access	Type Constraints	Units	Default Value
BitRate	Gauge32	read-only		BPS	
RequestedBandwidth	UnsignedInt	read-only			

#### 7.2.1.10.4.1 CcapMpegInputProg Object Attributes

##### 7.2.1.10.4.1.1 BitRate

Indicates the measured MPEG input program bitrate in bits per second.

##### 7.2.1.10.4.1.2 RequestedBandwidth

Requested bandwidth for this MPEG input program. This value is used to validate the total QAM bandwidth before allowing the creation of a new session. It is also used to validate the input program bandwidth overflow situation during the transmission. In the case of special stream without PCR, it is used to limit the output bandwidth of that special program.

A zero (0) value is returned if no bandwidth validation is done on this program.

#### 7.2.1.10.5 CcapMpegOutputProg

This object augments the mpegOutputProgTable of the SCTE-HMS-MPEG-MIB with the addition of a BitRate attribute.

No further modifications have been made to this table.

Reference: [SCTE 154-4]

**Table 7-54 - CcapMpegOutputProg Object Attributes**

Attribute Name	Type	Access	Type Constraints	Units	Default Value
BitRate	Gauge32	read-only		BPS	

#### 7.2.1.10.5.1 CcapMpegOutputProg Object Attributes

##### 7.2.1.10.5.1.1 BitRate

Indicates the measured MPEG output program bitrate in bits per second.

#### 7.2.1.10.6 VideoSession

The VideoSession object is taken from the SCTE-HMS-MPEG-MIB specified in [SCTE 154-4] and used without modification for the CCAP.

#### 7.2.1.10.7 CcapDecryptSession

The CcapDecryptSession extends the existing VideoSession object from the SCTE-HMS-MPEG-MIB specified in [SCTE 154-4] and used without modification for the CCAP. This table is only populated with video sessions that require CCAP decryption.

Reference: [SCTE 154-4]

#### 7.2.1.10.8 CcapMpegInputProgVideoSession

This object reports the list of video sessions that the MPEG input program are feeding.

**Table 7-55 - CcapMpegInputProgVideoSession Object Attributes**

Attribute Name	Type	Access	Type Constraints	Units	Default Value
InputTSIndex	TSIndexType	key			
InputProgIndex	ProgramIndexType	key			

Attribute Name	Type	Access	Type Constraints	Units	Default Value
VideoSessionIndex	UnsignedInt	key			
VideoSessionStatus	Enum	read-only	active(1), closed(2)		

**Table 7-56 - CcapMpegInputProgVideoSession Object Associations**

Associated Object Name	Type	Near-end Multiplicity	Far-end Multiplicity	Label
CcapMpegInputProg	Directed association to CcapMpegInputProg			
VideoSession	Directed association to VideoSession			
InputTS	Directed association to InputTS			

7.2.1.10.8.1 CcapMpegInputProgVideoSession Object Attributes

**7.2.1.10.8.1.1 InputTSIndex**

The index of the input TS.

**7.2.1.10.8.1.2 InputProgIndex**

The index of the input program.

**7.2.1.10.8.1.3 VideoSessionIndex**

The index of the video session.

**7.2.1.10.8.1.4 VideoSessionStatus**

The status of the video session.

7.2.1.10.9 InputTS

The InputTS object is taken from the SCTE-HMS-MPEG-MIB specified in [SCTE 154-4] and used without modification for the CCAP.

Reference: [SCTE 154-4]

**7.2.1.11 SCTE-HMS-MPEG-MIB: State Objects**

The objects in the SCTE-HMS-MPEG-MIB: State Objects are taken from [SCTE 154-4] and used with the following modifications for the CCAP.

The CcapMpegInputProg object replaces the MpegInputProg object from the SCTE-HMS-MPEG-MIB. It is defined in Section 7.2.1.10.4, CcapMpegInputProg.

The CcapMpegOutputProg object replaces the MpegOutputProg object from the SCTE-HMS-MPEG-MIB. It is defined in Section 7.2.1.10.5, CcapMpegOutputProg.

Reference: [SCTE 154-4]



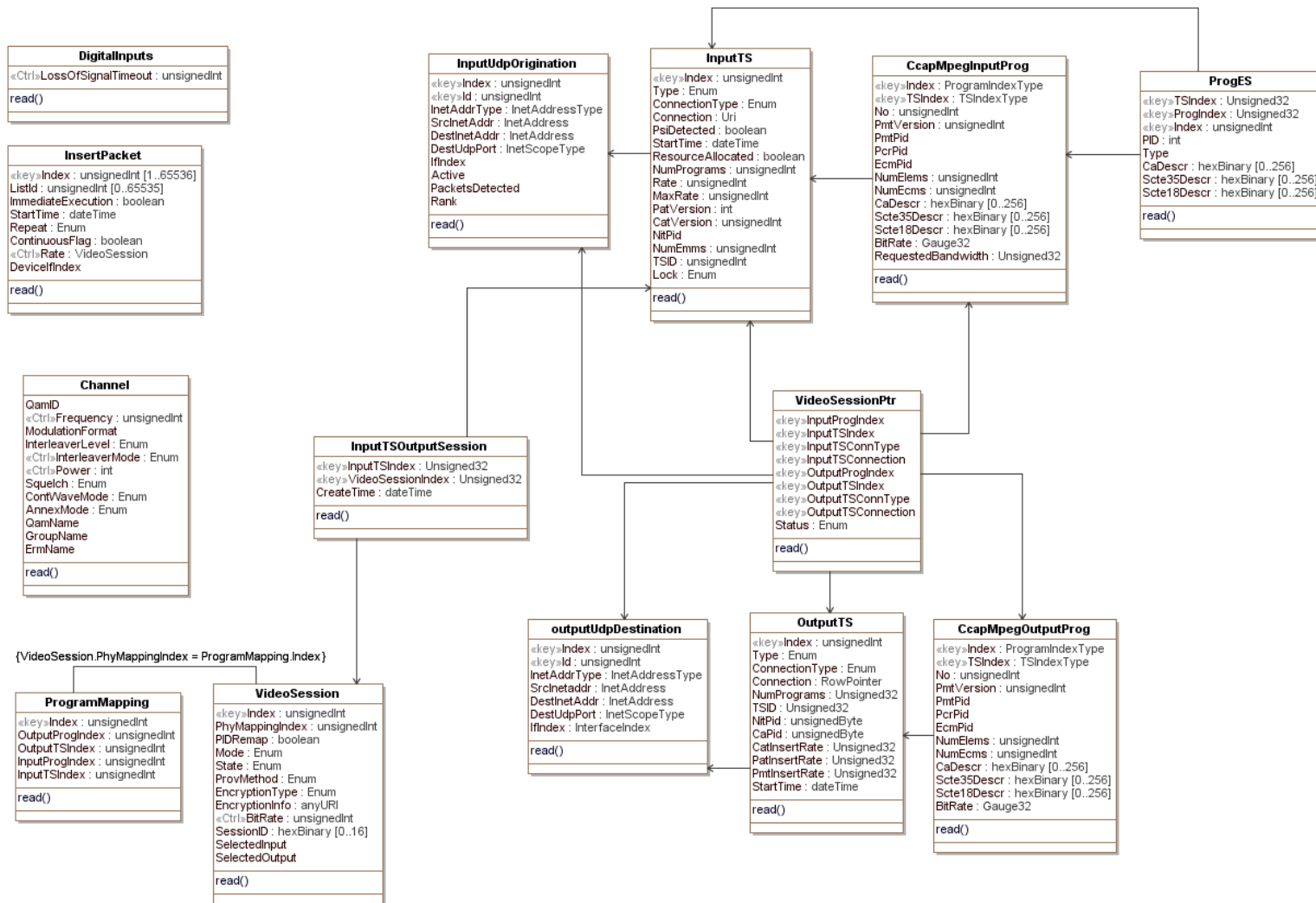
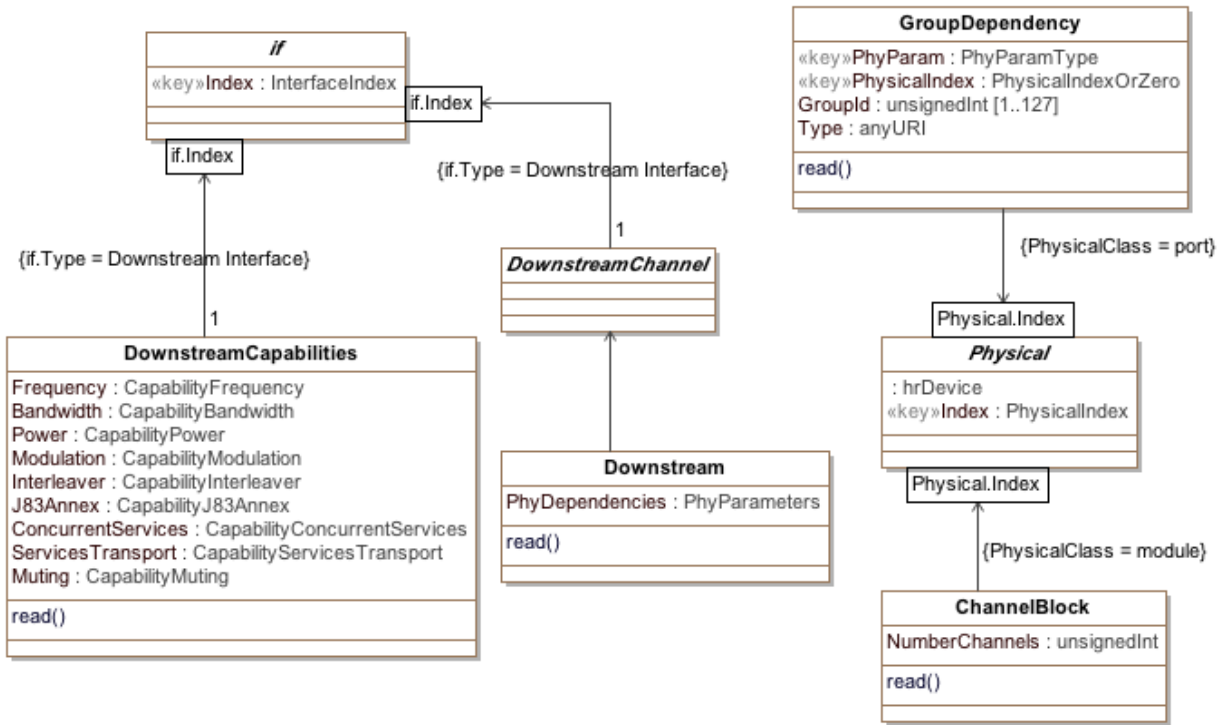

Figure 7-12 - SCTE-HMS-MPEG-MIB: State Objects Performance Management Objects

**7.2.1.12 DOCS-DRF-MIB**

The objects in the DOCS-DRF-MIB: State Objects are taken from the DOCS-DRF-MIB [DRFI] specified in Annex A of [M-OSSI] and used without modification for the CCAP.

References: [M-OSSI], DOCS-DRF-MIB, [DRFI]



**Figure 7-13 - DOCS-DRF-MIB Performance Management Objects**

## 7.2.2 Statistical Data Objects

### 7.2.2.1 DOCS-IF-MIB

The objects in the DOCS-IF-MIB are taken from [RFC 4546] and used without modification for the CCAP.

Reference: [RFC 4546]



Figure 7-14 - DOCS-IF-MIB Performance Management Objects

### 7.2.2.2 CMTS CM Status<sup>110</sup>

This section defines status and performance management objects for CMs which are instantiated at the CCAP, thus providing the NMS a central place to retrieve critical CM-related information without having to poll individual

<sup>110</sup> This section and subsections modified per CCAP-OSSiv3.1-N-15.1259-1 on 3/6/15 by KB; per CCAP-OSSiv3.1-N-15.1307-3 on 6/1/15 by KB..

CMs. Some objects originated in the DOCS-IF3-MIB are specified in [DOCS-IF3-MIB], but these have been replaced (CmtsCmUsStatus) or extended (CmtsCmRegStatus) for use with DOCSIS 3.1.

Reference: [DOCS-IF3-MIB] and [DOCS-IF31-MIB]

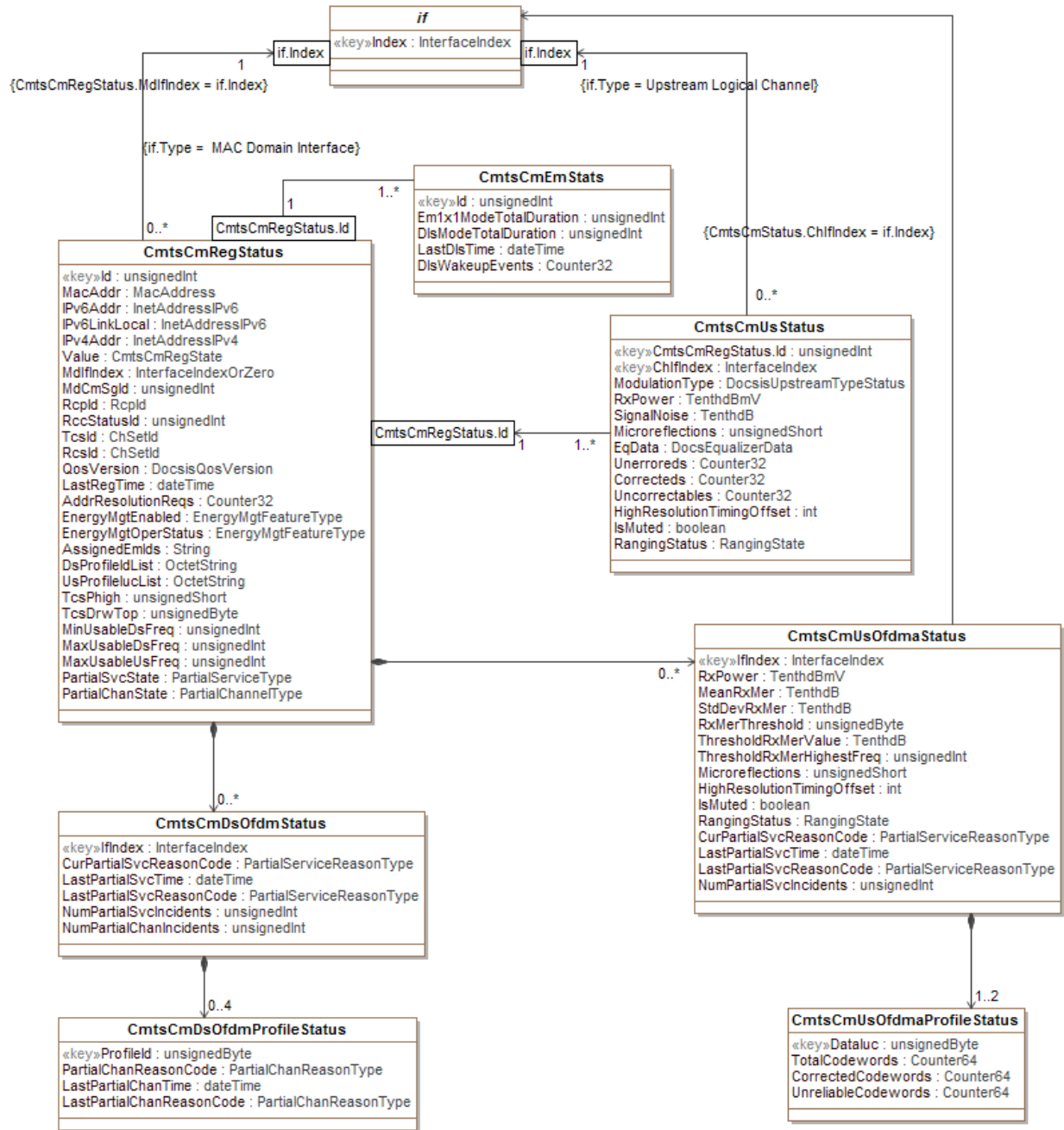

Figure 7-15 - CMTS CM Status Information Model<sup>111</sup>

<sup>111</sup> Modified per CCAP-OSSlv3.1-N-15.1307-3 on 6/1/15 by KB; per CCAP-OSSlv3.1-N-15.1390-2 on 11/11/15 by KB; per CCAP-OSSlv3.1-N-16.1519-1 and CCAP-OSSlv3.1-N-16.1544-2 on 11/15/16 by KB.

### 7.2.2.2.1 CmtsCmRegStatus<sup>112</sup>

This object defines attributes that represent the CM's registration status as tracked by the CMTS. Refer to the individual attribute definitions for applicability to 3.0 and 3.1 Cable Modems.

**Table 7-57 - CmtsCmRegStatus Object<sup>113</sup>**

Attribute Name	Type	Access	Type Constraints	Units
Id	unsignedInt	key	1..4294967295	N/A
MacAddr	MacAddress	read-only		N/A
Ipv6Addr	InetAddressIPv6	read-only		N/A
Ipv6LinkLocal	InetAddressIPv6	read-only		N/A
Ipv4Addr	InetAddressIPv4	read-only		N/A
Value	CmtsCmRegState	read-only		N/A
MdlfIndex	InterfaceIndexOrZero	read-only		N/A
MdCmSgld	unsignedInt	read-only		N/A
Rcpld	Rcpld	read-only		N/A
RccStatusId	unsignedInt	read-only		N/A
RcsId	ChSetId	read-only		N/A
TcsId	ChSetId	read-only		N/A
QosVersion	DocsisQosVersion	read-only		N/A
LastRegTime	dateTime	read-only		N/A
AddrResolutionReqs	Counter32	read-only		N/A
EnergyMgtEnabled	EnumBits	read-only	em1x1Mode(0), dlsMode(1)	N/A
EnergyMgtOperStatus	EnumBits	read-only	em1x1Mode(0), dlsMode(1)	N/A
AssignedEmIds	OctetString	read-only	SIZE(0   2   4   6 )	N/A
DsProfileIdList	OctetString	read-only	SIZE (0   6..72)	N/A
UsProfileIdList	OctetString	read-only	SIZE (0   6..72)	N/A
TcsPhigh	UnsignedShort	read-only	0   68..320	Quarterd BmV
TcsDrwTop	UnsignedByte	read-only	N/A	Quarterd BmV
MinUsableDsFreq	UnsignedInt	read-only		Hz
MaxUsableDsFreq	UnsignedInt	read-only		Hz
MaxUsableUsFreq	UnsignedInt	read-only		Hz
PartialSvcState	PartialServiceType	read-only		N/A
PartialChanState	PartialChannelType	read-only		N/A

#### 7.2.2.2.1.1 Id

This attribute uniquely identifies a CM. The CMTS **MUST** assign a single id value for each CM MAC address seen by the CMTS. The CMTS **SHOULD** ensure that the association between an Id and MAC Address remains constant during CMTS uptime.

#### 7.2.2.2.1.2 MacAddr

This attribute demotes the MAC address of the CM. If the CM has multiple MAC addresses, this is the MAC address associated with the MAC Domain interface.

<sup>112</sup> Modified per CCAP-OSSiv3.1-N-16.1430-2 on 5/13/16 by KB.

<sup>113</sup> Modified per CCAP-OSSiv3.1-N-15.1307-3 on 6/1/15 by KB; per CCAP-OSSiv3.1-N-16.1430-2 on 5/13/16 by KB; per CCAP-OSSiv3.1-N-16.1553-1 on 11/16/16 by KB.

#### 7.2.2.2.1.3 Ipv6Addr

This attribute denotes the IPv6 address of the CM. If the CM has no Internet address assigned, or the Internet address is unknown, the value of this attribute is the all zeros address.

#### 7.2.2.2.1.4 Ipv6LinkLocal

This attribute denotes the IPv6 local scope address of the CM.

#### 7.2.2.2.1.5 Ipv4Addr

This attribute denotes the IPv4 address of the CM. If the CM has no IP address assigned, or the IP address is unknown, this object returns 0.0.0.0.

#### 7.2.2.2.1.6 Value

This attribute denotes the current CM connectivity state.

References: [MULPIv3.1] Cable Modem Initialization and Reinitialization section.

#### 7.2.2.2.1.7 MdlfIndex

This attribute denotes the interface Index of the CMTS MAC Domain where the CM is active. If the interface is unknown, the CMTS returns a value of zero.

#### 7.2.2.2.1.8 MdCmSgld

This attribute denotes the ID of the MAC Domain CM Service Group Id (MD-CM-SG-ID) in which the CM is registered. If the ID is unknown, the CMTS returns a value of zero.

References: [MULPIv3.1] Cable Modem Service Group (CM-SG) section.

#### 7.2.2.2.1.9 Rcpld

This attribute denotes the RCP-ID associated with the CM if it is in DOCSIS 3.0 mode. If the RCP-ID is unknown or the CM is in DOCSIS 3.1 mode, the CMTS returns a five octet long string of zeros.

References: [MULPIv3.1] RCP-ID section in the Common Radio Frequency Interface Encodings Annex.

#### 7.2.2.2.1.10 RccStatusId

This attribute denotes the RCC Id the CMTS used to configure the CM receive channel set during the registration process, if it is in DOCSIS 3.0 mode. If unknown or the CM is in DOCSIS 3.1 mode, the CMTS returns the value zero.

#### 7.2.2.2.1.11 Rcslid

This attribute denotes the Receive Channel Set (RCS) that the CM is currently using. If the RCS is unknown, the CMTS returns the value zero.

References: [MULPIv3.1] Cable Modem Physical Receive Channel Configuration section and the Receive Channels section in the Common Radio Frequency Interface Encodings Annex.

#### 7.2.2.2.1.12 TcsId

This attribute denotes Transmit Channel Set (TCS) the CM is currently using. If the TCS is unknown, the CMTS returns the value zero.

References: [MULPIv3.1] Changes to the Transmit Channel Set section.

#### 7.2.2.2.1.13 QoSVersion

This attribute denotes the queuing services the CM registered, and will always report DOCSIS 1.1 QoS mode since DOCSIS 1.0 CoS mode has been deprecated in DOCSIS 3.1.

#### 7.2.2.2.1.14 LastRegTime

This attribute denotes the last time the CM registered.

#### 7.2.2.2.1.15 AddrResolutionReqs

This attribute denotes the number of upstream packets received on the SIDs assigned to a CM that are any of the following:

- Upstream IPv4 ARP Requests
- Upstream IPv6 Neighbor Solicitation Requests
- (For Routing CMTSs) Upstream IPv4 or IPv6 packets to unresolved destinations in locally connected downstream in the HFC.

Discontinuities in the value of this counter can occur at re-initialization of the managed system, and at other times as indicated by the value of ifCounterDiscontinuityTime for the associated MAC Domain interface.

References: [SECV3.1] Secure Provisioning section; [RFC 2863].

#### 7.2.2.2.1.16 EnergyMgtEnabled

This attribute indicates which, if any, of the Energy Management Features are enabled for this CM. If this attribute returns em1x1Mode(0) bit set, the CM is configured with the Energy Management 1x1 Feature enabled. If this attribute returns dlsMode(1) bit set, the CM is configured with the DLS Mode feature enabled. If this attribute returns all bits cleared, the CM will not request to operate in any Energy Management mode of operation.

**NOTE:** This attribute only indicates if an Energy Management Feature is enabled/disabled via the CM config file and registration request/response exchange and does not indicate whether the CM is actively operating in an Energy Management Mode.

References: [MULPIv3.1] Energy Management Features section.

#### 7.2.2.2.1.17 EnergyMgtOperStatus

This attribute indicates whether the CM is currently operating in an Energy Management Mode. If this attribute returns em1x1Mode(0) bit set, the CM is operating in Energy Management 1x1 Mode. If this attribute returns dlsMode(1) bit set, the CM is operating in DLS Mode. If this attribute returns all bits cleared, the CM is not operating in any Energy Management Mode. This attribute always returns 0x00 (no bits set) in the case when EnergyMgtEnabled is set to 0x00 (no Energy Management Features enabled).

**NOTE:** dlsMode(1) and em1x1Mode(0) are mutually exclusive, thus a return value where both of these bits are 'true' is invalid.<sup>114</sup>

References: [MULPIv3.1] Energy Management 1x1 Mode Indicator section.

#### 7.2.2.2.1.18 AssignedEmIds<sup>115</sup>

This attribute reports the set of CMTS-assigned EM-IDs for this CM. This attribute is encoded as an array 16-bit binary values with up to 3 elements. The broadcast EM-ID is not included in the list. This is generally displayed as a comma-delimited list of EM-IDS such as: DF13,ABAB,0002. If the EM-ID is unknown, the CMTS returns a zero length string.

This object is applicable to DOCSIS 3.1 modems but not to prior versions of DOCSIS modems. If the CM is a pre-DOCSIS 3.1 modem, the CMTS returns a zero-length string.

<sup>114</sup> Note added per CCAP-OSSiv3.1-N-15.1307-3 on 6/1/15 by KB.

<sup>115</sup> Modified per CCAP-OSSiv3.1-N-15.1307-3 on 6/1/15 by KB.

References: [MULPIv3.1] DOCSIS Light Sleep Feature section.

#### 7.2.2.2.1.19 DsProfileIdList<sup>116</sup>

This attribute is a variable length series of hexadecimal octets where each series entry consists of the following fields (encoded in the following order):

The ifIndex (4 octets) of the OFDM channel where the downstream Profile IDs are assigned.

The number or count of Profile IDs (1 octet with valid values of 1-4) assigned to the CM on that channel.

The list of Profile IDs (1 octet each with valid values of 0-15) assigned to this CM on that channel. Profile ID 0 is commonly referred to as Profile A. Likewise, Profile IDs 1, 2 and 3 are commonly referred to as Profiles B, C and D.

The CCAP MUST encode each OFDM channel in a CM's RCS as a separate n-octet entry in the DsProfileIdList.

Examples: a CM with a single OFDM channel (ifIndex 34) and four assigned profiles (Profiles IDs 0, 8, 9 and 10) would have a ProfileIdList value of 0x00000022040008090A. A CM with a 2 OFDM channel bonding group each with two assigned profiles (Profile IDs 0 and 15 on channel with ifIndex 34 and Profile IDs 0 and 14 on channel with ifIndex 35) would have a DsProfileIdList value of 0x0000002202000F0000002302000E.

The CCAP MUST NOT include the transitional profile or test profile in the DsProfileIdList.

Note that octet string lengths greater than 18 are optional.

This object is applicable to DOCSIS 3.1 modems but not to prior versions of DOCSIS modems. If the CM is a pre-DOCSIS 3.1 modem, the CMTS returns a zero-length octet string.

#### 7.2.2.2.1.20 UsProfileIucList<sup>117</sup>

This attribute is a variable length series of hexadecimal octets where each series entry consists of the following fields (encoded in the following order):

The ifIndex (4 octets) of the OFDMA channel where the Profile IUCs are assigned.

The number (or count) of Data IUCs (1 octet with valid values of 1-2) assigned to this CM on that channel.

The list of Data IUCs (1 octet each with valid values of 5, 6, 9-13) assigned to this CM on that channel.

The CCAP MUST encode each OFDMA channel in a CM's TCS as a separate n-octet entry in the UsProfileIucList.

Examples: a CM with a single OFDMA channel (ifIndex 36) and two assigned Data IUCs (5 and 6) would have a ProfileIdList value of 0x00000024020506. A CM with a 2 OFDMA channel bonding group each with one assigned Data IUC (IUC 5 on channel with ifIndex 34 and IUC 13 on channel with ifIndex 35) would have a UsProfileIucList value of 0x00000022010500000023010D.

The CCAP MUST NOT include transitional IUCs or test IUCs in the UsProfileIucList.

This object is applicable to DOCSIS 3.1 modems but not to prior versions of DOCSIS modems. If the CM is a pre-DOCSIS 3.1 modem, the CMTS returns a zero-length octet string.

#### 7.2.2.2.1.21 TcsPhigh

This attribute reports the  $P_{1.6\text{dB}}$  value for the CM's Transmit Channel Set [PHYv3.1]. This object is applicable to DOCSIS 3.1 modems but not to prior versions of DOCSIS modems. If the CM is a pre-DOCSIS 3.1 modem, the CMTS returns zero.

<sup>116</sup> Modified per CCAP-OSSv3.1-N-15.1307-3 on 6/1/15 by KB; per CCAP-OSSv3.1-N-16.1430-2 and 16.1467-2 on 5/13/16 by KB.

<sup>117</sup> Modified per CCAP-OSSv3.1-N-15.1307-3 on 6/1/15 by KB; per CCAP-OSSv3.1-N-16.1430-2 and 16.1467-2 on 5/13/16 by KB..



#### 7.2.2.2.1.22 TcsDrwTop

This attribute reports the level of the top of the Dynamic Range Window. The value is expressed in dBmV and is the result of a calculation equal to  $P_{1.6hi} - P_{1.6load\_min\_set}$  [PHYv3.1]. This object is applicable to DOCSIS 3.1 modems but not to prior versions of DOCSIS modems. If the CM is a pre-DOCSIS 3.1 modem, the CMTS returns zero.

#### 7.2.2.2.1.23 MinUsableDsFreq

This attribute is the higher of the CCAP's minimum supported downstream frequency and the CM's minimum supported downstream frequency. It indicates the lowest downstream frequency the CCAP can use to communicate with this CM taking into account the capabilities of both devices. This object is applicable to DOCSIS 3.1 modems but not to prior versions of DOCSIS modems. If the CM is a pre-DOCSIS 3.1 modem, the CMTS returns zero.

#### 7.2.2.2.1.24 MaxUsableDsFreq

This attribute is the lower of the CCAP's maximum supported downstream frequency and the CM's maximum supported downstream frequency. It indicates the highest downstream frequency the CCAP can use to communicate with this CM taking into account the capabilities of both devices. This object is applicable to DOCSIS 3.1 modems but not to prior versions of DOCSIS modems. If the CM is a pre-DOCSIS 3.1 modem, the CMTS returns zero.

#### 7.2.2.2.1.25 MaxUsableUsFreq

This attribute is the lower of the CCAP's maximum supported upstream frequency and the CM's maximum supported upstream frequency. It indicates the highest upstream frequency the CCAP can use to receive signals from this CM taking into account the capabilities of both devices. This object is applicable to DOCSIS 3.1 modems but not to prior versions of DOCSIS modems. If the CM is a pre-DOCSIS 3.1 modem, the CMTS returns zero.

#### 7.2.2.2.1.26 PartialSvcState<sup>118</sup>

This attribute indicates the type of "bonding group" issue that this CM is experiencing, based on what the MAC-layer shows. This object is applicable to DOCSIS 3.1 modems but not to prior versions of DOCSIS modems. If the CM is a pre-DOCSIS 3.1 modem, the CMTS returns 'other'.

#### 7.2.2.2.1.27 PartialChanState<sup>119</sup>

This attribute is a bit-field which indicates the type of OFDM channel issue that this CM is experiencing, based on what the MAC-layer shows. See *PartialChannelType* for further detail. This object is applicable to DOCSIS 3.1 modems but not to prior versions of DOCSIS modems. If the CM is a pre-DOCSIS 3.1 modem, the CMTS returns no bits set (0x0).

### 7.2.2.2.2 CmtsCmUsStatus

This object defines status information of the CM currently in use by Upstream Logical Channels, as reported by the CMTS.

**Table 7-58 - CmtsCmUsStatus Object**

Attribute Name	Type	Access	Type Constraints	Units
Id	unsignedInt	key	1..4294967295	N/A
ChIfIndex	InterfaceIndex	key		N/A
ModulationType	DocsisUpstreamType	read-only		N/A
RxPower	TenthdBmV	read-only		TenthdBmV
SignalNoise	TenthdB	read-only		TenthdB

<sup>118</sup> Added per CCAP-OSSiv3.1-N-15.1307-3 on 6/1/15 by KB; modified per CCAP-OSSiv3.1-15.1390-2 on 11/11/15 by KB.

<sup>119</sup> Added per CCAP-OSSiv3.1-N-15.1307-3 on 6/1/15 by KB; modified per CCAP-OSSiv3.1-15.1390-2 on 11/11/15 by KB.

Attribute Name	Type	Access	Type Constraints	Units
Microreflections	unsignedShort	read-only		dBc
EqData	DocsEqualizerData	read-only		N/A
Unerrored	Counter32	read-only		N/A
Correcteds	Counter32	read-only		N/A
Uncorrectables	Counter32	read-only		N/A
HighResolutionTimingOffset	int	read-only		time tick/(64*256)
IsMuted	boolean	read-only		N/A
RangingStatus	Enum	read-only	other(1) aborted(2) retriesExceeded(3) success(4) continue(5) timeoutT4(6)	N/A

#### 7.2.2.2.2.1 Id

This attribute represents the CMTS assigned Id to the CM in the CmtsCmRegStatus object.

#### 7.2.2.2.2.2 ChIfIndex

This attribute represents an upstream logical interface. The CMTS instantiates each one of the channels in the current Transmit Channel Set of the CM in this object.

#### 7.2.2.2.2.3 ModulationType

This attribute represents the modulation type currently used by this upstream channel.

#### 7.2.2.2.2.4 RxPower<sup>120</sup>

This attribute represents the receive power of this upstream channel. The reported value represents the total average power for the channel regardless of whether the CM is reporting Pr, total average power, or P1.6r, the power spectral density in an equivalent 1.6 MHz spectrum.

#### 7.2.2.2.2.5 SignalNoise

This attribute represents Signal/Noise ratio as perceived for upstream data from the CM on this upstream channel.

#### 7.2.2.2.2.6 Microreflections

This attribute represents microreflections received on this upstream channel.

#### 7.2.2.2.2.7 EqData

This attribute represents the equalization data for the CM on this upstream channel.

#### 7.2.2.2.2.8 Unerrored

This attribute represents the codewords received without error from the CM on this upstream channel. Discontinuities in the value of this counter can occur at re-initialization of the managed system, and at other times as indicated by the value of ifCounterDiscontinuityTime for the associated upstream channel.

References: [RFC 2863].

<sup>120</sup> Modified per CCAP-OSSv3.1-N-16.1464-3 on 5/13/16 by KB.

#### 7.2.2.2.9 Correcteds

This attribute represents the codewords received with correctable errors from the CM on this upstream channel. Discontinuities in the value of this counter can occur at re-initialization of the managed system, and at other times as indicated by the value of `ifCounterDiscontinuityTime` for the associated upstream channel.

References: [RFC 2863].

#### 7.2.2.2.10 Uncorrectables

This attribute represents the codewords received with uncorrectable errors from the CM on this upstream channel. Discontinuities in the value of this counter can occur at re-initialization of the managed system, and at other times as indicated by the value of `ifCounterDiscontinuityTime` for the associated upstream channel.

References: [RFC 2863].

#### 7.2.2.2.11 HighResolutionTimingOffset

This attribute represents the current measured round trip time on this CM's upstream channel in units of  $(6.25 \text{ microseconds} / (64 * 256))$ . This attribute returns zero if the value is unknown.

#### 7.2.2.2.12 IsMuted

This attribute has a value 'true' to indicate that the CM's upstream channel has been muted via CM-CTRL-REQ/CM-CTRL-RSP message exchange.

References: [MULPIv3.1] Media Access Control Specification section.

#### 7.2.2.2.13 RangingStatus

This attribute denotes ranging status of the CM on this upstream channel as reported by the CMTS.

The enumerated values associated with the RangingStatus are:

- 'other' indicates any state not described below.
- 'aborted' indicates that the CMTS has sent a ranging abort.
- 'retriesExceeded' indicates CM ranging retry limit has been exceeded.
- 'success' indicates that the CMTS has sent a ranging success in the ranging response.
- 'continue' indicates that the CMTS has sent a ranging continue in the ranging response.
- 'timeoutT4' indicates that the T4 timer expired on the CM.

References: [MULPIv3.1] Media Access Control Specification section.

### 7.2.2.3 CmtsCmUsOfdmaStatus<sup>121</sup>

This object defines status information of the CM currently in use by Upstream Logical Channels, as reported by the CMTS.

**Table 7-59 - CmtsCmUsOfdmaStatus Object**

Attribute Name	Type	Access	Type Constraints	Units
IfIndex	InterfaceIndex	key		N/A
RxPower	TenthdBmV	read-only		TenthdBmV
MeanRxMer	HundredthdB	read-only		HundredthdB
StdDevRxMer	HundredthdB	read-only		HundredthdB
RxMerThreshold	unsignedByte	read-write	1..99	Percentile

<sup>121</sup> Added per CCAP-OSSiv3.1-N-15.1307-3 on 6/1/15 by KB; modified per CCAP-OSSiv3.1-15.1390-2 on 11/11/15 by KB; per CCAP-OSSiv3.1-N-16.1519-1 on 11/15/16 by KB.

Attribute Name	Type	Access	Type Constraints	Units
ThresholdRxMerValue	QuarterdB	read-only		QuarterdB
ThresholdRxMerHighestFreq	unsignedInt	read-only		Hz
Microreflections	unsignedShort	read-only		dBc
HighResolutionTimingOffset	int	read-only		time tick/(64*256)
IsMuted	boolean	read-only		N/A
RangingStatus	Enum	read-only	other(1) aborted(2) retriesExceeded(3) success(4) continue(5) timeoutT4(6)	N/A
CurPartialSvcReasonCode	PartialSvcReasonType	read-only		
LastPartialSvcTime	DateTime	read-only		
LastPartialSvcReasonCode	PartialSvcReasonType	read-only		
NumPartialSvcIncidents	Counter32	read-only		

#### 7.2.2.2.3.1 IfIndex

This attribute represents an OFDMA upstream interface. The CMTS instantiates each one of the channels in the current Transmit Channel Set of the CM in this object.

#### 7.2.2.2.3.2 RxPower

This attribute is the total received power in a specified OFDMA channel, normalized to power in a 1.6 MHz bandwidth, at the RF input port of the CMTS for a given CM.

Reference: [PHYv3.1] Upstream Channel Power section

#### 7.2.2.2.3.3 MeanRxMer

This attribute is the mean of the dB values of the RxMER measurements of all active subcarriers. The mean is computed directly on the dB values as follows:

$$\text{Mean} = \text{sum of (RxMER dB values)} / \text{number of RxMER values}$$

Reference: [PHYv3.1] Upstream Receive Modulation Error Ratio (RxMER) Per Subcarrier section

#### 7.2.2.2.3.4 StdDevRxMer<sup>122</sup>

This attribute is the standard deviation of the dB values of the RxMER measurements of all active subcarriers. The standard deviation is computed directly on the dB values as follows:

$$\text{StdDev} = \sqrt{\text{sum of (RxMER dB values - RxMER\_mean)}^2 / \text{number of RxMER values}}$$

#### 7.2.2.2.3.5 RxMerThreshold

This attribute specifies the percentile (such as 2<sup>nd</sup> percentile or 5<sup>th</sup> percentile) of all active subcarriers in an OFDM channel at which the ThresholdRxMerValue occurs. That is, (Percentile) % of the subcarriers have RxMER <= ThresholdRxMerValue.

#### 7.2.2.2.3.6 ThresholdRxMer

This attribute is the RxMER value corresponding to the specified RxMerThreshold percentile value. The CCAP sorts the subcarriers in ascending order of RxMER, resulting in a post-sorting subcarrier index ranging from 1 to the number of active subcarriers. If the percentile value corresponds to a non-integer post-sorting subcarrier index, the post-sorting index is truncated (floor function is applied); that is, the post-sorting index is selected which is the

<sup>122</sup> Modified per CCAP-OSSv3.1-15.1390-2 on 11/11/15 by KB.

greatest integer less than or equal to the corresponding percentile value. For example, if there are 3677 active subcarriers and the 2<sup>nd</sup> percentile is specified, the CCAP computes  $\text{floor}(3677 * 0.02) = 73$ . That is, the RxMER value of the 73<sup>rd</sup> subcarrier in the sorted list is associated with the 2<sup>nd</sup> percentile.

#### 7.2.2.2.3.7 ThresholdRxMerHighestFreq

This attribute is the frequency in Hz of the highest-frequency subcarrier having RxMER = ThresholdRxMer value.

#### 7.2.2.2.3.8 Microreflections

This attribute represents microreflections received on this upstream channel.

#### 7.2.2.2.3.9 HighResolutionTimingOffset

This attribute represents the current measured round trip time on this CM's upstream channel in units of  $(6.25 \text{ microseconds} / (64 * 256))$ . This attribute returns zero if the value is unknown.

#### 7.2.2.2.3.10 IsMuted

This attribute has a value 'true' to indicate that the CM's upstream channel has been muted via CM-CTRL-REQ/CM-CTRL-RSP message exchange.

References: [MULPIv3.1] Media Access Control Specification section.

#### 7.2.2.2.3.11 RangingStatus

This attribute denotes ranging status of the CM on this upstream channel as reported by the CMTS.

The enumerated values associated with the RangingStatus are:

- Other: 'other' indicates any state not described below.
- Aborted: 'aborted' indicates that the CMTS has sent a ranging abort.
- retriesExceeded: 'retriesExceeded' indicates CM ranging retry limit has been exceeded.
- Success: 'success' indicates that the CMTS has sent a ranging success in the ranging response.
- Continue: 'continue' indicates that the CMTS has sent a ranging continue in the ranging response.
- timeoutT4: 'timeoutT4' indicates that the T4 timer expired on the CM.

References: [MULPIv3.1] Media Access Control Specification section.

#### 7.2.2.2.3.12 CurPartialSvcReasonCode

This attribute returns the current CM-STATUS Event Code which indicates the reason that this CM is experiencing Partial Service with a bonding group utilizing this upstream OFDMA channel. A value of 0 indicates that the CM is not currently experiencing Partial Service involving this OFDMA channel.

#### 7.2.2.2.3.13 LastPartialSvcTime

This attribute returns the date and time when the MAC indicated that this CM recovered from its most recent Partial Service incident on this upstream OFDMA channel.

#### 7.2.2.2.3.14 LastPartialSvcReasonCode

This attribute returns the last CM-STATUS Event Code which indicates the reason that this CM was experiencing Partial Service on this upstream OFDMA channel. (Note: if the CM is currently experiencing Partial Service, this is the Event Code from the previous Partial Service event.) A value of 0 indicates that the CM has not experienced Partial Service involving this OFDMA channel during the CCAP's history of this CM.

7.2.2.2.3.15 NumPartialSvcIncidents

This attribute returns the number of Partial Service incidents the MAC layer has reported for this CM on this upstream OFDMA channel.

7.2.2.2.4 CmtsCmUsOfdmaProfileStatus<sup>123</sup>

This object defines current status information of the CM on each OFDMA upstream channel profile, as reported by the CMTS.

**Table 7-60 - CmtsCmUsOfdmaProfileStatus Object<sup>124</sup>**

Attribute Name	Type	Access	Type Constraints	Units
Dataluc	unsignedByte	Key	5 6 9 10 11 12 13	NA
TotalCodewords	Counter64	read-only		
CorrectedCodewords	Counter64	read-only		
UnreliableCodewords	Counter64	read-only		

7.2.2.2.4.1 Dataluc

This attribute is the Dataluc associated with this upstream OFDMA profile.

7.2.2.2.4.2 TotalCodewords

This attribute represents the count of the total number of FEC codewords received from the CM on this Profile/Data IUC for this upstream OFDMA channel.

Discontinuities in the value of this counter can occur at re-initialization of the managed system, and at other times as indicated by the value of ifCounterDiscontinuityTime for the associated upstream OFDMA channel.

7.2.2.2.4.3 CorrectedCodewords

This attribute represents the count of codewords received that failed the pre-decoding syndrome check, but passed the post-decoding syndrome check from the CM on this Profile/Data IUC for this upstream OFDMA channel.

Discontinuities in the value of this counter can occur at re-initialization of the managed system, and at other times as indicated by the value of ifCounterDiscontinuityTime for the associated upstream OFDMA channel.

7.2.2.2.4.4 UnreliableCodewords

This attribute represents the count of codewords that failed the post-decoding syndrome check received from the CM on this Profile/Data IUC for this upstream OFDMA channel.

Discontinuities in the value of this counter can occur at re-initialization of the managed system, and at other times as indicated by the value of ifCounterDiscontinuityTime for the associated upstream OFDMA channel.

7.2.2.2.5 CmtsCmDsOfdmStatus<sup>125</sup>

This object defines current status information of the CM on each OFDM downstream channel, as reported by the CMTS. A separate instance exists for every OFDM channel of every CM currently assigned to an OFDMA channel. If the CM has never experienced a partial service or partial channel event with respect to this channel since the last CCAP reinitialization, no instance should exist for this object. Instances of this object should persist across CM reinitialization.

<sup>123</sup> Added per CCAP-OSSv3.1-N-15.1307-3 on 6/1/15 by KB; per CCAP-OSSv3.1-N-16.1519-1 on 11/15/16 by KB.

<sup>124</sup> Modified per CCAP-OSSv3.1-N-16.1439-3 on 5/13/16 by KB.

<sup>125</sup> Added per CCAP-OSSv3.1-N-15.1307-3 on 6/1/15 by KB.

**Table 7-61 - CmtsCmDsOfdmStatus Object**

Attribute Name	Type	Access	Type Constraints	Units
IfIndex	InterfaceIndex	Key		
CurPartialSvcReasonCode	PartialSvcReasonType	read-only		
LastPartialSvcTime	dateTime	read-only		
LastPartialSvcReasonCode	PartialSvcReasonType	read-only		
NumPartialSvcIncidents	Counter32	read-only		
NumPartialChanIncidents	Counter32	read-only		

#### 7.2.2.2.5.1 IfIndex

This attribute represents an OFDM downstream interface.

#### 7.2.2.2.5.2 CurPartialSvcReasonCode

This attribute returns the current CM-STATUS Event Code which indicates the reason that this CM is experiencing Partial Service with a bonding group utilizing this downstream OFDM channel. A value of 0 indicates that the CM is not currently experiencing Partial Service involving this OFDM channel.

#### 7.2.2.2.5.3 LastPartialSvcTime

This attribute returns the date and time when the MAC indicated that this CM recovered from its most recent Partial Service incident on this downstream OFDM channel.

#### 7.2.2.2.5.4 LastPartialSvcReasonCode

This attribute returns the last CM-STATUS Event Code which indicates the reason that this CM was experiencing Partial Service on this downstream OFDM channel. (Note: if the CM is currently experiencing Partial Service, this is the Event Code from the previous Partial Service event.) A value of 0 indicates that the CM has not experienced Partial Service involving this OFDM channel during the CCAP's history of this CM.

#### 7.2.2.2.5.5 NumPartialSvcIncidents

This attribute returns the number of Partial Service incidents the MAC layer has reported for this CM on this downstream OFDM channel.

#### 7.2.2.2.5.6 NumPartialChanIncidents

This attributes returns the number of Partial Channel incidents the MAC layer has reported for this CM on this downstream OFDM channel.

#### 7.2.2.2.6 CmtsCmDsOfdmProfileStatus<sup>126</sup>

This object defines current status information of the CM on each OFDM downstream channel profile, as reported by the CMTS. If the CM has never experienced a partial channel event with respect to this profile since the last CCAP reinitialization, no instance should exist for this object. Instances of this object should persist across CM reinitialization.

<sup>126</sup> Added per CCAP-OSSiv3.1-N-15.1307-3 on 6/1/15 by KB; modified per CCAP-OSSiv3.1-15.1390-2 on 11/11/15 by KB; per CCAP-OSSiv3.1-N-16.1544-2 on 11/16/16 by KB.

**Table 7-62 - CmtsCmdsOfdmProfileStatus Object<sup>127</sup>**

Attribute Name	Type	Access	Type Constraints	Units
ProfileId	unsignedByte	Key	0..15	
PartialChanReasonCode	PartialChanReasonType	read-only		
LastPartialChanTime	dateTime	read-only		
LastPartialChanReasonCode	PartialChanReasonType	read-only		

#### 7.2.2.2.6.1 ProfileId

This attribute is a unique index and is the identifier of the downstream profile associated with the OFDM downstream channel. The value of this key attribute is zero-based due to constraints of the definition of Profile Id.

Reference: [MULPIv3.1] Downstream Profile Descriptor (DPD) section

#### 7.2.2.2.6.2 PartialChanReasonCode

This attribute returns the current CM-STATUS Event Code which indicates the reason that this CM is in a Partial Channel state utilizing this Profile on this downstream OFDM channel. A value of 0 indicates that the CM is not currently experiencing Partial Channel involving this Profile on this OFDM channel.

#### 7.2.2.2.6.3 LastPartialChanTime

This attribute returns the date and time when the MAC indicated that this CM recovered from its most recent Partial Channel incident for this Profile on this downstream OFDM channel.

#### 7.2.2.2.6.4 LastPartialChanReasonCode

This attribute returns the last CM-STATUS Event Code which indicates the reason that this CM was experiencing a Partial Channel event for this Profile on this downstream OFDM channel. A value of 0 indicates that the CM has not experienced a Partial Channel incident involving this Profile on this OFDM channel during the CCAP's maintained history of this CM.

#### 7.2.2.2.7 CmtsCmEmStats<sup>128</sup>

This object defines Energy Management mode statistics for the CM as reported by the CMTS. For example, such metrics can provide insight into configuration of appropriate EM 1x1 Mode Activity Detection thresholds on the CM and/or to get feedback on how/if the current thresholds are working well or are causing user experience issues.

**Table 7-63 - CmtsCmEmStats Object**

Attribute Name	Type	Access	Type Constraints	Units
Id	unsignedInt	key	1..4294967295	N/A
Em1x1ModeTotalDuration	unsignedInt	read-only		seconds
DlsModeTotalDuration	unsignedInt	read-only		seconds
LastDlsTime	dateTime	read-only		
DlsWakeUpEvents	Counter32	read-only		

#### 7.2.2.2.7.1 Id

This key represents the CMTS assigned Id to the CM in the CmtsCmRegStatus object. A row exists in this table for every CM capable of Energy Management (either 1x1 or DLS).

<sup>127</sup> Modified per CCAP-OSSv3.1-15.1390-2 on 11/11/15 by KB

<sup>128</sup> Section and subsections modified per CCAP-OSSv3.1-N-15.1307-3 on 6/1/15 by KB.



#### 7.2.2.2.7.2 Em1x1ModeTotalDuration

This attribute indicates the total time duration, in seconds since registration, the CM identified by Id has been in Energy Management 1x1 mode, as controlled by the DBC-REQ Energy Management 1x1 Mode Indicator TLV.

#### 7.2.2.2.7.3 DlsModeTotalDuration

This attribute indicates the total time duration, in seconds since registration, the CM identified by Id has been in DOCSIS Light Sleep mode.

#### 7.2.2.2.7.4 LastDlsTime

This attribute indicates the time of the last DLS wakeup event for this CM. If this CM is currently in DLS mode, then this attribute returns 0.

#### 7.2.2.2.7.5 DlsWakeupEvents

This attribute indicates the total number of wakeup events that this CM has experienced over the CCAP's history for this CM.

### 7.2.2.3 DOCS-L2VPN-MIB Statistics Objects

The objects in the DOCS-L2VPN-MIB: Statistics Objects are taken from the DOCS-L2VPN-MIB specified in Annex A of [L2VPN] and are used without modification for the CCAP.

Reference: [L2VPN], DOCS-L2VPN-MIB

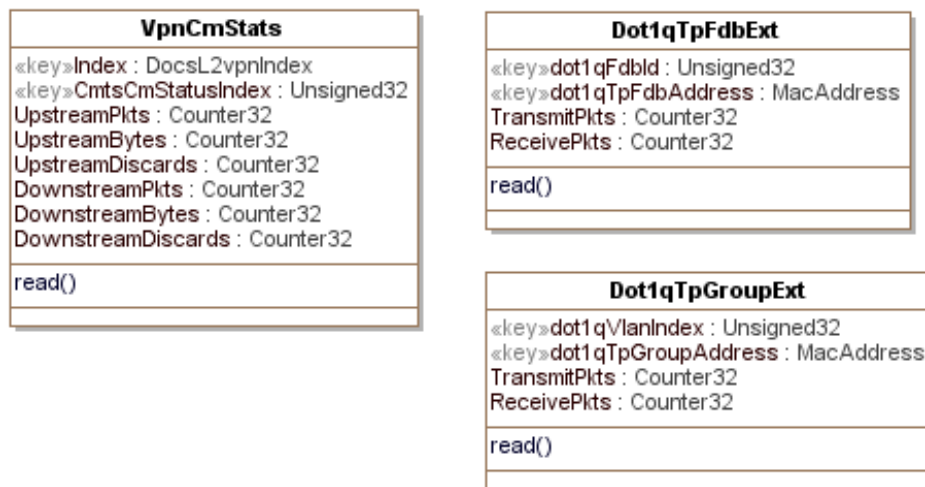

Figure 7-16 - DOCS-L2VPN-MIB: Statistics Objects

### 7.2.2.4 DOCS-MCAST-MIB

The following objects in the DOCS-MCAST-MIB are taken from the [DOCS-MCAST-MIB] and used without modification for the CCAP:

- if
- CmtsReplSess

The docsBpi2CmtsIpMulticastMapTable object is taken from the DOCS-IETF-BPI2-MIB specified in [RFC 4131] and used without modification for the CCAP.

This Information Model provides the replication and reporting aspects of multicast sessions for the CMTS. The components of the Multicast status reporting model are:

- CmtsReplSess, Multicast Sessions replications per MAC domain for the CMTS.
- Aggregate Admitted Multicast Bandwidth either per MAC domain or Downstream Channel Set.<sup>129</sup>

---

<sup>129</sup> Bullet added per CCAP-OSSv3.1-N-15.1307-3 on 6/1/15 by KB.

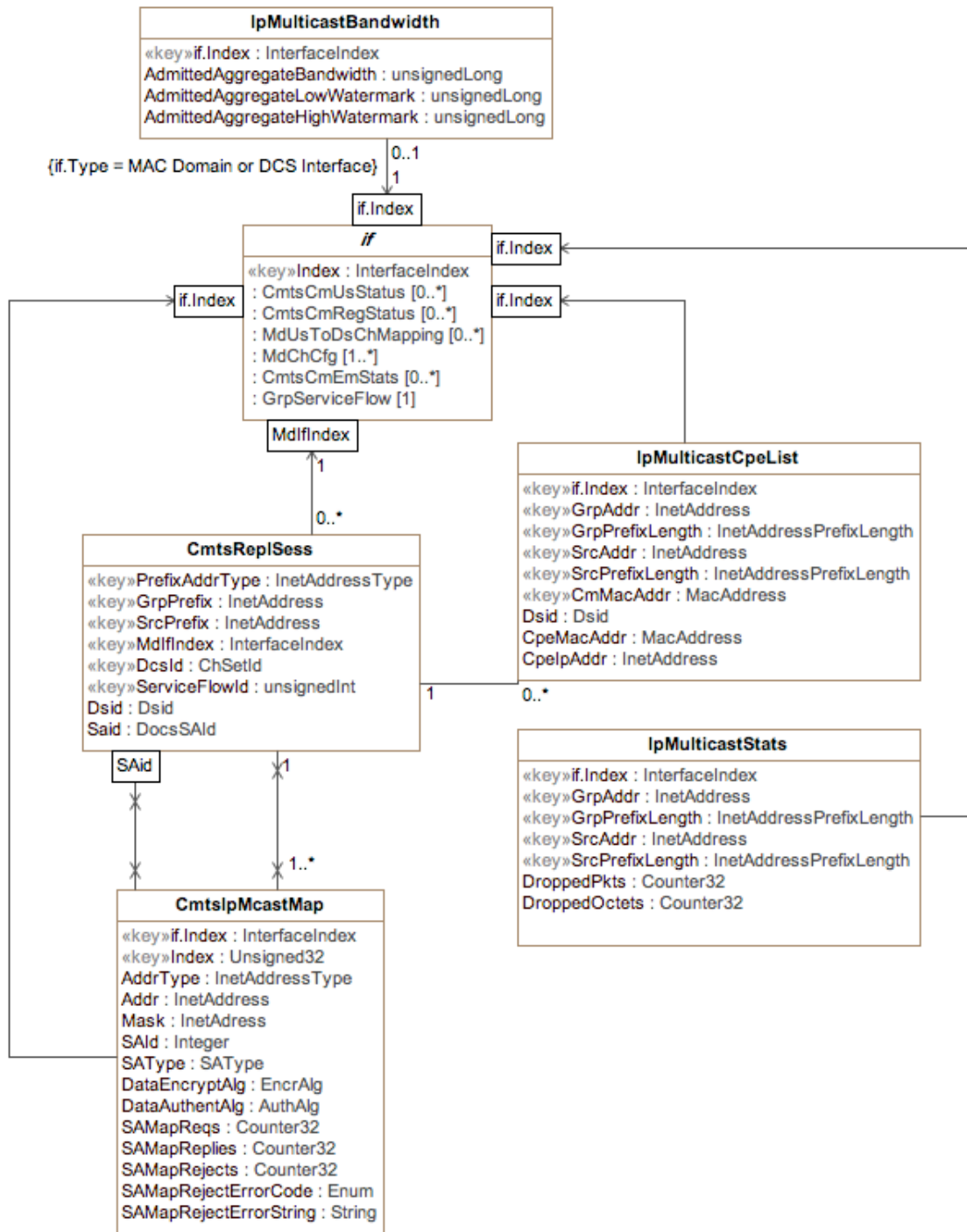

Figure 7-17 - DOCS-MCAST-MIB Performance Management Objects<sup>130</sup>

#### 7.2.2.4.1 CmtsReplSess Object

This object describes the replication of IP Multicast sessions onto the different Downstream Channel Sets of a CMTS. Each DCS may be either a single downstream channel or a bonding group of multiple downstream channels.

<sup>130</sup> Modified per CCAP-OSSiv3.1-N-15.1307-3 on 6/1/15 by KB.

Each IP Multicast session is identified by a combination of IP source and IP Destination group address (S,G). The CMTS replicates each IP packet in an (S,G) session onto one or more Downstream Channel Sets (DCSs), each of which is implemented in a MAC Domain. The CMTS assigns each replication a Downstream Service ID (DSID) that is unique per MAC Domain.

**Table 7-64 - CmtsReplSess Object**

Attribute Name	Type	Access	Type Constraints	Units	Default
PrefixAddrType	InetAddressType	key	ipv4(1) ipv6(2)	N/A	N/A
GrpPrefix	InetAddress	key		N/A	N/A
SrcPrefix	InetAddress	key		N/A	N/A
MdlfIndex	InterfaceIndex	key		N/A	N/A
DcsId	ChSetId	key		N/A	N/A
ServiceFlowId	unsignedInt	key	1..4294967295	N/A	N/A
Dsid	Dsid	read-only		N/A	N/A
Said	DocsSAid	read-only	1..16383	N/A	N/A

#### 7.2.2.4.1.1 PrefixAddrType

This attribute defines the address type for the GrpPrefix and SrcPrefix addresses.

#### 7.2.2.4.1.2 GrpPrefix

This attribute defines the group G of a particular (S,G) IP multicast session.

#### 7.2.2.4.1.3 SrcPrefix

This attribute identifies a specific Multicast Source Address. A Source Address that is all zeros is defined as 'all source addresses (\*, G)'.  
References: [RFC 3569] section 6; [RFC 3306] sections 5 and 6.

#### 7.2.2.4.1.4 MdlfIndex

This attribute defines the MAC Domain Interface index of the channel to which the (S,G) session is replicated.

#### 7.2.2.4.1.5 DcsId

This attribute provides the reference for the Downstream Channel within a MAC Domain that the multicast session (S,G) is replicated to.

#### 7.2.2.4.1.6 ServiceFlowId

This attribute indicates the service flow into which packets are classified for this replication of the multicast session (S,G).

#### 7.2.2.4.1.7 Dsid

This attribute defines the Downstream Service ID (DSID) label with which the CMTS labels all packets of the (S,G) session on the DCS of a MAC Domain. The DSID value is unique per MAC domain.

#### 7.2.2.4.1.8 Said

This attribute defines the Security Association ID (SAID) of this multicast replication session. The value 0 indicates no SAID associated with this session.

#### 7.2.2.4.2 *IpMulticastStats Object*<sup>131</sup>

This object contains statistics for the IP multicast session identified by the combination of IP source and IP destination group address (S,G).

**Table 7-65 - IpMulticastStats Object**

Attribute Name	Type	Access	Type Constraints	Units	Default
IfIndex	InterfaceIndex	key	Ethernet Interface(s)	N/A	N/A
GrpAddr	InetAddress	key		N/A	N/A
GrpPrefixLength	InetAddressPrefixLength	key		N/A	N/A
SrcAddr	InetAddress	key		N/A	N/A
SrcPrefixLength	InetAddressPrefixLength	key		N/A	N/A
DroppedPkts	Counter32	read-only		packets	N/A
DroppedOctets	Counter32	read-only		bytes	N/A

##### 7.2.2.4.2.1 IfIndex

This attribute defines the Ethernet Interface index to which the (S,G) IP multicast session applies.

##### 7.2.2.4.2.2 GrpAddr

This attribute defines 'G' as the group address for a particular (S,G) IP multicast session.

##### 7.2.2.4.2.3 GrpPrefixLength

This attribute defines the group address prefix length of a particular (S,G) IP multicast session.

##### 7.2.2.4.2.4 SrcAddr

This attribute defines 'S' as the source address for a particular (S,G) IP multicast session. For the case of Any Source Multicast (ASM), this attribute uses a value of 0.0.0.0 for IPv4 or 0::/0 for IPv6.

##### 7.2.2.4.2.5 SrcPrefixLength

This attribute defines the source address prefix length of a particular (S,G) IP multicast session.

##### 7.2.2.4.2.6 DroppedPkts

This attribute returns a count of the packets dropped by the CMTS Forwarder process for a particular IP multicast session prior to replication to the outbound interface(s) (e.g., MAC domain interfaces). These packet drops can occur whenever there are no replications for this IP multicast session, or where an IP multicast packet for the specific S,G is not forwarded to the outbound interface(s).

##### 7.2.2.4.2.7 DroppedOctets

This attribute returns a count of the octets for packets dropped by the CMTS Forwarder process for a particular IP multicast session prior to replication to the outbound interface(s).

<sup>131</sup> Added per CCAP-OSSiv3.1-N-15.1307-3 on 6/1/15 by KB.

### 7.2.2.4.3 *IpMulticastCpeList Object*<sup>132</sup>

This object contains CPE information for the IP multicast session identified by the combination of IP source and IP destination group address (S,G), MAC Domain interface and CM MAC address.

**Table 7-66 - IpMulticastCpeList Object**

Attribute Name	Type	Access	Type Constraints	Units	Default
IfIndex	InterfaceIndex	key	MAC Domain interface(s)	N/A	N/A
GrpAddr	InetAddress	key		N/A	N/A
GrpPrefixLength	InetAddressPrefixLength	key		N/A	N/A
SrcAddr	InetAddress	key		N/A	N/A
SrcPrefixLength	InetAddressPrefixLength	key		N/A	N/A
CmMacAddr	MacAddress	key		N/A	N/A
Dsid	Dsid	read-only		N/A	N/A
CpeMacAddr	MacAddress	read-only		N/A	N/A
CpelpAddr	InetAddress	read-only		N/A	N/A

#### 7.2.2.4.3.1 IfIndex

This attribute defines the MAC Domain Interface index to which the (S,G) IP multicast session applies.

#### 7.2.2.4.3.2 GrpAddr

This attribute defines 'G' as the group address for a particular (S,G) IP multicast session.

#### 7.2.2.4.3.3 GrpPrefixLength

This attribute defines the group address prefix length of a particular (S,G) IP multicast session.

#### 7.2.2.4.3.4 SrcAddr

This attribute defines 'S' as the source address for a particular (S,G) IP multicast session. For the case of Any Source Multicast (ASM), this attribute uses a value of 0.0.0.0 for IPv4 or 0::/0 for IPv6.

#### 7.2.2.4.3.5 SrcPrefixLength

This attribute defines the source address prefix length of a particular (S,G) IP multicast session.

#### 7.2.2.4.3.6 CmMacAddr

This attribute defines the CM MAC address of a particular (S,G) IP multicast session.

#### 7.2.2.4.3.7 Dsid

This attribute defines the Downstream Service ID (DSID) label with which the CMTS labels all packets of a particular (S,G) IP multicast session.

#### 7.2.2.4.3.8 CpeMacAddr

This attribute returns the CPE MAC address for the (S,G) IP multicast session.

#### 7.2.2.4.3.9 CpelpAddr

This attribute returns the CPE IP address for the (S,G) IP multicast session.

<sup>132</sup> Added per CCAP-OSSv3.1-N-15.1307-3 on 6/1/15 by KB.

#### 7.2.2.4.4 *IpMulticastBandwidth Object*<sup>133</sup>

This object describes the admitted aggregate bandwidth of IP Multicast sessions onto the different Downstream Channel Sets or MAC Domain Interfaces of a CMTS. In addition to the current aggregate multicast bandwidth, the high and low watermarks are included as attributes.

**Table 7-67 - IpMulticastBandwidth Object**

Attribute Name	Type	Access	Type Constraints	Units	Default
IfIndex	InterfaceIndex	key	MAC Domain or DCS Interfaces	N/A	N/A
AdmittedAggregateBandwidth	Unsigned64	R/O		bps	N/A
AdmittedAggregateLowWatermark	Unsigned64	R/O		bps	N/A
AdmittedAggregateHighWatermark	Unsigned64	R/O		bps	N/A

##### 7.2.2.4.4.1 IfIndex

This attribute represents the MAC Domain Interface or Downstream Channel Set interface index associated with the Admitted Multicast Aggregate Bandwidth data.

Note that for some vendors this CMTS cable interface will be a cable-mac interface. For others, it will be a DOCSIS Downstream Channel Set. In either case, this CMTS cable interface exists as a row entry in the ifTable (and therefore has an ifIndex which can be used as an index for this object).

##### 7.2.2.4.4.2 AdmittedAggregateBandwidth

This attribute represents the Admitted Multicast Aggregate Bandwidth which is defined as the sum of the Minimum Reserved Traffic Rates of each Group Service Flow that has been admitted on a given CMTS cable interface.

##### 7.2.2.4.4.3 AdmittedAggregateLowWatermark

This attribute represents the low watermark threshold for Admitted Multicast Aggregate Bandwidth events.

##### 7.2.2.4.4.4 AdmittedAggregateHighWatermark

This attribute represents the high watermark threshold for Admitted Multicast Aggregate Bandwidth events.

#### 7.2.2.5 **DOCSIS QoS Statistical Information Model**<sup>134</sup>

The section defines statistical performance management objects in the DOCS-QOS3-MIB.

Reference: [DOCS-QOS3-MIB]

<sup>133</sup> Added per CCAP-OSSiv3.1-N-15.1307-3 on 6/1/15 by KB.

<sup>134</sup> Modified per CCAP-OSSiv3.1-N-16.1528-2 on 11/15/16 by KB; per CCAP-OSSiv3.1-N-16.1618-3 on 11/17/16 by KB.

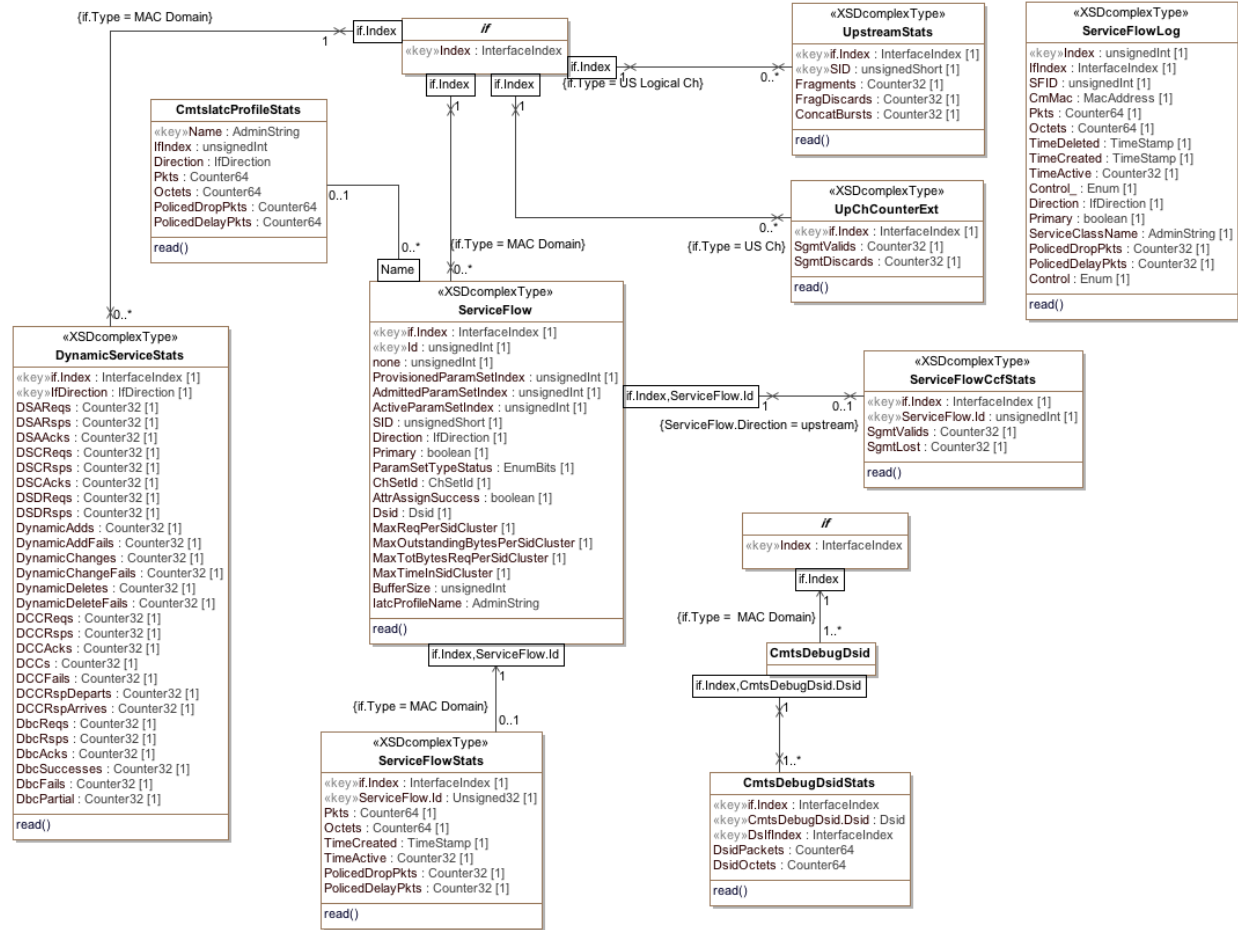

Figure 7-18 – DOCSIS QoS Statistical Performance Management Information Model<sup>135</sup>

7.2.2.5.1 ServiceFlowStats

This object describes statistics associated with the Service Flows in a managed device.

Table 7-68 - ServiceFlowStats Object

Attribute Name	Type	Access	Type Constraints	Units	Default
ifIndex	InterfaceIndex	key	Interface Index of MAC Domain interface	N/A	N/A
ServiceFlowId	Unsigned32	key	1..4294967295	N/A	N/A
Pkts	Counter64	read-only		packets	N/A
Octets	Counter64	read-only		bytes	N/A
Created	TimeStamp	read-only		N/A	N/A
Active	Counter32	read-only		seconds	N/A
PolicedDropPkts	Counter32	read-only		packets	N/A
PolicedDelayPkts	Counter32	read-only		packets	N/A

7.2.2.5.1.1 ifIndex

This key represents the interface index of the MAC Domain of the Service Flow.

<sup>135</sup> Modified per CCAP-OSSv3.1-N-16.1433-1 on 5/13/16 by KB; per CCAP-OSSv3.1-N-16.1517-1 and CCAP-OSSI-N-16.1528-2 on 11/15/16 by KB; per CCAP-OSSv3.1-N-16.1618-3 on 11/17/16 by KB.



#### 7.2.2.5.1.2 ServiceFlowId

This key represents an identifier assigned to a Service Flow by CMTS within a MAC Domain.

#### 7.2.2.5.1.3 Pkts

For outgoing Service Flows, this attribute counts the number of Packet Data PDUs forwarded to this Service Flow. For incoming upstream CMTS service flows, this attribute counts the number of Packet Data PDUs actually received on the Service Flow identified by the SID for which the packet was scheduled. CMs not classifying downstream packets may report this attribute's value as 0 for downstream Service Flows. This attribute does not count MAC-specific management messages. Particularly for UGS flows, packets sent on the primary Service Flow in violation of the UGS grant size should be counted only by the instance of this attribute that is associated with the primary service flow. Unclassified upstream user data packets (i.e., non- MAC-management) forwarded to the primary upstream Service Flow should be counted by the instance of this attribute that is associated with the primary service flow. This attribute does include packets counted by ServiceFlowPolicedDelayPkts, but does not include packets counted by ServiceFlowPolicedDropPkts. This counter's last discontinuity is the ifCounterDiscontinuityTime for of the associated MAC Domain interface index.

#### 7.2.2.5.1.4 Octets

This attribute indicates the count of the number of octets from the byte after the MAC header HCS to the end of the CRC for all packets counted in the ServiceFlowPkts attribute for this row. Note that this counts the octets after payload header suppression and before payload header expansion have been applied. This counter's last discontinuity is the ifCounterDiscontinuityTime for of the associated MAC Domain interface index.

#### 7.2.2.5.1.5 Created

This attribute indicates the value of sysUpTime when the service flow was created.

#### 7.2.2.5.1.6 Active

This attribute indicates the number of seconds that the service flow has been active. This counter's last discontinuity is the ifCounterDiscontinuityTime for of the associated MAC Domain interface index.

#### 7.2.2.5.1.7 PolicedDropPkts

For outgoing service flows, this attribute counts the number of Packet Data PDUs classified to this service flow dropped due to: (1) exceeding the selected Buffer Size for the service flow (see the Buffer Control section in the Common Radio Frequency Interface Encodings Annex of [MULPIv3.1]); or (2) UGS packets dropped due to exceeding the Unsolicited Grant Size with a Request/Transmission policy that requires such packets to be dropped. Classified packets dropped due to other reasons needs to be counted in ifOutDiscards for the interface of this service flow. This attribute reports 0 for incoming service flows. This counter's last discontinuity is the ifCounterDiscontinuityTime for of the associated MAC Domain interface index.

#### 7.2.2.5.1.8 PolicedDelayPkts

This attribute counts only outgoing packets delayed in order to maintain the Maximum Sustained Traffic Rate. This attribute will always report a value of 0 for UGS flows because the Maximum Sustained Traffic Rate does not apply. This attribute is 0 for incoming service flows. This counter's last discontinuity is the ifCounterDiscontinuityTime for of the associated MAC Domain interface index.

#### 7.2.2.5.2 UpstreamStats

This object describes statistics associated with upstream service flows. All counted frames need to be received without a Frame Check Sequence (FCS) error.

**Table 7-69 - UpstreamStats Object**

Attribute Name	Type	Access	Type Constraints	Units
ifIndex	InterfaceIndex	key	Interface Index of Upstream Logical Channel	N/A
SID	unsignedShort	key		N/A
Fragments	Counter32	read-only		fragments
FragDiscards	Counter32	read-only		fragments
ConcatBursts	Counter32	read-only		headers

#### 7.2.2.5.2.1 ifIndex

This key represents the interface index of the logical upstream interface to which this instance applies.

#### 7.2.2.5.2.2 SID

This key identifies a service ID for an admitted or active upstream service flow.

#### 7.2.2.5.2.3 Fragments

This attribute indicates the number of fragmentation headers received on an upstream service flow, regardless of whether the fragment was correctly reassembled into a valid packet. This counter's last discontinuity is the ifCounterDiscontinuityTime for of the associated MAC Domain interface index.

#### 7.2.2.5.2.4 FragDiscards

This attribute indicates the number of upstream fragments discarded and not assembled into a valid upstream packet. This counter's last discontinuity is the ifCounterDiscontinuityTime for of the associated MAC Domain interface index.

#### 7.2.2.5.2.5 ConcatBursts

This attribute indicates the number of concatenation headers received on an upstream service flow. This counter's last discontinuity is the ifCounterDiscontinuityTime for of the associated MAC Domain interface index.

#### 7.2.2.5.3 DynamicServiceStats

This object describes statistics associated with the Dynamic Service Flows, Dynamic Channel Changes and Dynamic Bonding Changes in a managed device within a MAC Domain. For each MAC Domain there are two instances for the for the upstream and downstream direction. On the CMTS, the downstream direction instance indicates messages transmitted or transactions originated by the CMTS. The upstream direction instance indicates messages received or transaction originated by the CM. On the CM, the downstream direction instance indicates messages received or transactions originated by the CMTS. The upstream direction instance indicates messages transmitted by the CM or transactions originated by the CM.

**Table 7-70 - DynamicServiceStats Object**

Attribute Name	Type	Access	Type Constraints	Units
ifIndex	InterfaceIndex	key	Interface Index of MAC Domain interface	N/A
IfDirection	IfDirection	read-only		N/A
DSAReqs	Counter32	read-only		messages
DSARsps	Counter32	read-only		messages
DSAAcks	Counter32	read-only		messages
DSCReq	Counter32	read-only		messages
DSCRsps	Counter32	read-only		messages
DSCAcks	Counter32	read-only		messages
DSDReq	Counter32	read-only		messages
DSDRsps	Counter32	read-only		messages

Attribute Name	Type	Access	Type Constraints	Units
DynamicAdds	Counter32	read-only		messages
DynamicAddFails	Counter32	read-only		messages
DynamicChanges	Counter32	read-only		messages
DynamicChangeFails	Counter32	read-only		messages
DynamicDeletes	Counter32	read-only		messages
DynamicDeleteFails	Counter32	read-only		messages
DCCRqs	Counter32	read-only		messages
DCCRspS	Counter32	read-only		messages
DCCAcks	Counter32	read-only		messages
DCCs	Counter32	read-only		messages
DCCFails	Counter32	read-only		messages
DCCRspDeparts	Counter32	read-only		messages
DCCRspArrives	Counter32	read-only		messages
DbcRqs	Counter32	read-only		messages
DbcRspS	Counter32	read-only		messages
DbcAcks	Counter32	read-only		messages
DbcSuccesses	Counter32	read-only		transactions
DbcFails	Counter32	read-only		transactions
DbcPartial	Counter32	read-only		transactions

#### 7.2.2.5.3.1 ifIndex

This key represents the interface index of the MAC Domain.

#### 7.2.2.5.3.2 IfDirection

This attribute indicates the interface direction for the instance the statistics are collected.

#### 7.2.2.5.3.3 DSARqs

This attribute indicates the number of Dynamic Service Addition Requests, including retries. Discontinuities in the value of this counter can occur at reinitialization of the managed system, and at other times as indicated by the value of ifCounterDiscontinuityTime of the associated MAC Domain interface index.

References: [MULPIv3.1] Dynamic Service Addition section; [RFC 2863].

#### 7.2.2.5.3.4 DSARspS

The number of Dynamic Service Addition Responses, including retries. Discontinuities in the value of this counter can occur at reinitialization of the managed system, and at other times as indicated by the value of ifCounterDiscontinuityTime of the associated MAC Domain interface index.

References: [MULPIv3.1] Dynamic Service Addition section; [RFC 2863].

#### 7.2.2.5.3.5 DSAAcks

The number of Dynamic Service Addition Acknowledgements, including retries. Discontinuities in the value of this counter can occur at reinitialization of the managed system, and at other times as indicated by the value of ifCounterDiscontinuityTime of the associated MAC Domain interface index.

References: [MULPIv3.1] Dynamic Service Addition section; [RFC 2863].

#### 7.2.2.5.3.6 DSCReqS

The number of Dynamic Service Change Requests, including retries. Discontinuities in the value of this counter can occur at reinitialization of the managed system, and at other times as indicated by the value of ifCounterDiscontinuityTime of the associated MAC Domain interface index.

References: [MULPIv3.1] Dynamic Service Change section; [RFC 2863].

#### 7.2.2.5.3.7 DSCRsps

The number of Dynamic Service Change Responses, including retries. Discontinuities in the value of this counter can occur at reinitialization of the managed system, and at other times as indicated by the value of ifCounterDiscontinuityTime of the associated MAC Domain interface index.

References: [MULPIv3.1] Dynamic Service Change section; [RFC 2863].

#### 7.2.2.5.3.8 DSCAcks

The number of Dynamic Service Change Acknowledgements, including retries. Discontinuities in the value of this counter can occur at reinitialization of the managed system, and at other times as indicated by the value of ifCounterDiscontinuityTime of the associated MAC Domain interface index.

References: [MULPIv3.1] Dynamic Service Change section; [RFC 2863].

#### 7.2.2.5.3.9 DSDReqs

The number of Dynamic Service Delete Requests, including retries. Discontinuities in the value of this counter can occur at reinitialization of the managed system, and at other times as indicated by the value of ifCounterDiscontinuityTime of the associated MAC Domain interface index.

References: [MULPIv3.1] Dynamic Service Deletion section; [RFC 2863].

#### 7.2.2.5.3.10 DSDRsps

The number of Dynamic Service Delete Responses, including retries. Discontinuities in the value of this counter can occur at reinitialization of the managed system, and at other times as indicated by the value of ifCounterDiscontinuityTime of the associated MAC Domain interface index.

References: [MULPIv3.1] Dynamic Service Change section; [RFC 2863].

#### 7.2.2.5.3.11 DynamicAdds

The number of successful Dynamic Service Addition transactions. Discontinuities in the value of this counter can occur at reinitialization of the managed system, and at other times as indicated by the value of ifCounterDiscontinuityTime of the associated MAC Domain interface index.

References: [MULPIv3.1] Dynamic Service Addition section; [RFC 2863].

#### 7.2.2.5.3.12 DynamicAddFails

The number of failed Dynamic Service Addition transactions. Discontinuities in the value of this counter can occur at reinitialization of the managed system, and at other times as indicated by the value of ifCounterDiscontinuityTime of the associated MAC Domain interface index.

References: [MULPIv3.1] Dynamic Service Addition section; [RFC 2863].

#### 7.2.2.5.3.13 DynamicChanges

The number of successful Dynamic Service Change transactions. Discontinuities in the value of this counter can occur at reinitialization of the managed system, and at other times as indicated by the value of ifCounterDiscontinuityTime of the associated MAC Domain interface index.

References: [MULPIv3.1] Dynamic Service Change section; [RFC 2863].

#### 7.2.2.5.3.14 DynamicChangeFails

The number of failed Dynamic Service Change transactions. Discontinuities in the value of this counter can occur at reinitialization of the managed system, and at other times as indicated by the value of ifCounterDiscontinuityTime of the associated MAC Domain interface index.

References: [MULPIv3.1] Dynamic Service Change section; [RFC 2863].

#### 7.2.2.5.3.15 DynamicDeletes

The number of successful Dynamic Service Delete transactions. Discontinuities in the value of this counter can occur at reinitialization of the managed system, and at other times as indicated by the value of ifCounterDiscontinuityTime of the associated MAC Domain interface index.

References: [MULPIv3.1] Dynamic Service Delete section; [RFC 2863].

#### 7.2.2.5.3.16 DynamicDeleteFails

The number of failed Dynamic Service Delete transactions. Discontinuities in the value of this counter can occur at reinitialization of the managed system, and at other times as indicated by the value of ifCounterDiscontinuityTime of the associated MAC Domain interface index.

References: [MULPIv3.1] Dynamic Service Delete section; [RFC 2863].

#### 7.2.2.5.3.17 DCCReqs

The number of Dynamic Channel Change Request messages traversing an interface. This count is nonzero only on downstream direction rows. This count should include the number of retries. Discontinuities in the value of this counter can occur at reinitialization of the managed system, and at other times as indicated by the value of ifCounterDiscontinuityTime of the associated MAC Domain interface index.

References: [MULPIv3.1] Dynamic Downstream and/or Upstream Channel Changes section; [RFC 2863].

#### 7.2.2.5.3.18 DCCRsp

The number of Dynamic Channel Change Response messages traversing an interface. This count is nonzero only on upstream direction rows. This count should include the number of retries. Discontinuities in the value of this counter can occur at reinitialization of the managed system, and at other times as indicated by the value of ifCounterDiscontinuityTime of the associated MAC Domain interface index.

References: [MULPIv3.1] Dynamic Downstream and/or Upstream Channel Changes section; [RFC 2863].

#### 7.2.2.5.3.19 DCCAcks

The number of Dynamic Channel Change Acknowledgement messages traversing an interface. This count is nonzero only on downstream direction rows. This count should include the number of retries. Discontinuities in the value of this counter can occur at reinitialization of the managed system, and at other times as indicated by the value of ifCounterDiscontinuityTime of the associated MAC Domain interface index.

References: [MULPIv3.1] Dynamic Downstream and/or Upstream Channel Changes section; [RFC 2863].

#### 7.2.2.5.3.20 DCCs

The number of successful Dynamic Channel Change transactions. This count is nonzero only on downstream direction rows. Discontinuities in the value of this counter can occur at reinitialization of the managed system, and at other times as indicated by the value of ifCounterDiscontinuityTime of the associated MAC Domain interface index.

References: [MULPIv3.1] Dynamic Downstream and/or Upstream Channel Changes section; [RFC 2863].

#### 7.2.2.5.3.21 DCCFails

The number of failed Dynamic Channel Change transactions. This count is nonzero only on downstream direction rows. Discontinuities in the value of this counter can occur at reinitialization of the managed system, and at other times as indicated by the value of ifCounterDiscontinuityTime of the associated MAC Domain interface index.

References: [MULPIv3.1] Dynamic Downstream and/or Upstream Channel Changes section; [RFC 2863].

#### 7.2.2.5.3.22 DccRspDeparts

This attribute contains the number of Dynamic Channel Change Response (depart) messages. It only applies to upstream direction. Discontinuities in the value of this counter can occur at reinitialization of the managed system, and at other times as indicated by the value of ifCounterDiscontinuityTime of the associated MAC Domain interface index.

References: [MULPIv3.1] Dynamic Downstream and/or Upstream Channel Changes section; [RFC 2863].

#### 7.2.2.5.3.23 DccRspArrives

This attribute contains the number of Dynamic Channel Change Response (arrive) messages and should include retries. It only applies to the upstream direction. Discontinuities in the value of this counter can occur at reinitialization of the managed system, and at other times as indicated by the value of ifCounterDiscontinuityTime of the associated MAC Domain interface index.

References: [MULPIv3.1] Dynamic Downstream and/or Upstream Channel Changes section; [RFC 2863].

#### 7.2.2.5.3.24 DbcReqs

This attribute contains the number of Dynamic Bonding Change Requests, including retries. It only applies to the upstream direction. Discontinuities in the value of this counter can occur at reinitialization of the managed system, and at other times as indicated by the value of ifCounterDiscontinuityTime of the associated MAC Domain interface index.

References: [MULPIv3.1] Dynamic Bonding Change (DBC) section; [RFC 2863].

#### 7.2.2.5.3.25 DbcRsps

This attribute contains the number of Dynamic Bonding Change Responses, including retries. It only applies to the upstream direction. Discontinuities in the value of this counter can occur at reinitialization of the managed system, and at other times as indicated by the value of ifCounterDiscontinuityTime of the associated MAC Domain interface index.

References: [MULPIv3.1] Dynamic Bonding Change (DBC) section; [RFC 2863].

#### 7.2.2.5.3.26 DbcAcks

This attribute contains the number of Dynamic Bonding Change Acknowledgements, including retries. It only applies to the downstream direction. Discontinuities in the value of this counter can occur at reinitialization of the managed system, and at other times as indicated by the value of ifCounterDiscontinuityTime of the associated MAC Domain interface index.

References: [MULPIv3.1] Dynamic Bonding Change (DBC) section; [RFC 2863].

#### 7.2.2.5.3.27 DbcSuccesses

This attribute contains the number of fully successful Dynamic Bonding Change transactions. It only applies to the downstream direction and does not include DBC transactions that result in Partial Service. Discontinuities in the value of this counter can occur at reinitialization of the managed system, and at other times as indicated by the value of ifCounterDiscontinuityTime of the associated MAC Domain interface index.

References: [MULPIv3.1] Dynamic Bonding Change (DBC) section; [RFC 2863].

#### 7.2.2.5.3.28 DbcFails

This attribute contains the number of failed Dynamic Bonding Change transactions. It only applies to the downstream direction. Note that Partial Service is not considered a failed transaction. Discontinuities in the value of this counter can occur at reinitialization of the managed system, and at other times as indicated by the value of ifCounterDiscontinuityTime of the associated MAC Domain interface index.

References: [MULPIv3.1] Dynamic Bonding Change (DBC) section; [RFC 2863].

#### 7.2.2.5.3.29 DbcPartial

This attribute contains the number of unsuccessful Dynamic Bonding Change transactions that result in Partial Service. IT only applies to the downstream direction. Discontinuities in the value of this counter can occur at reinitialization of the managed system, and at other times as indicated by the value of ifCounterDiscontinuityTime of the associated MAC Domain interface index.

References: [MULPIv3.1] Dynamic Bonding Change (DBC) section; [RFC 2863].

#### 7.2.2.5.4 ServiceFlowLog

This object contains a log of the disconnected Service Flows in a managed device.

**Table 7-71 - ServiceFlowLog Object**

Attribute Name	Type	Access	Type Constraints	Units	Default
Index	unsignedInt	key		N/A	N/A
IfIndex	InterfaceIndex	read-only		N/A	N/A
SFID	unsignedInt	read-only		N/A	N/A
CmMac	MacAddress	read-only		N/A	N/A
Pkts	Counter64	read-only		packets	N/A
Octets	Counter64	read-only		bytes	N/A
TimeDeleted	TimeStamp	read-only		N/A	N/A
TimeCreated	TimeStamp	read-only		N/A	N/A
TimeActive	Counter32	read-only		seconds	N/A
Direction	RfMacIfDirection	read-only		N/A	N/A
Primary	boolean	read-only		N/A	N/A
ServiceClassName	SnmpAdminString	read-only		N/A	N/A
PolicedDropPkts	Counter32	read-only		packets	N/A
PolicedDelayPkts	Counter32	read-only		packets	N/A
Control	Enum	read-write	active(1) destroy(6)	N/A	N/A

##### 7.2.2.5.4.1 Index

This key indicates an unique index for a logged service flow.

##### 7.2.2.5.4.2 IfIndex

This attribute indicates the MAC Domain Interface index where the service flow was present.

##### 7.2.2.5.4.3 SFID

This attribute indicates the identifier assigned to the service flow.

##### 7.2.2.5.4.4 CmMac

This attribute indicates the MAC address of the cable modem associated with the service flow.

##### 7.2.2.5.4.5 Pkts

This attribute indicates the final value of the Pkts attribute in the ServiceFlowStats object for the service flow.

##### 7.2.2.5.4.6 Octets

This attribute indicates the final value of the Pkts attribute in the ServiceFlowStats object for the service flow.

7.2.2.5.4.7 TimeDeleted

This attribute indicates the value of sysUpTime when the service flow was deleted.

7.2.2.5.4.8 TimeCreated

This attribute indicates the value of sysUpTime when the service flow was created.

7.2.2.5.4.9 TimeActive

This attribute indicates the total time that the service flow was active.

7.2.2.5.4.10 Direction

This attribute indicates the value of Service Flow direction for the service flow.

7.2.2.5.4.11 Primary

If set to 'true', this attribute indicates that the Service Flow in the log was a Primary Service Flow, otherwise, a Secondary Service Flow.

7.2.2.5.4.12 ServiceClassName

This attribute indicates the value of ServiceClassName for the provisioned QoS Parameter Set of the service flow.

7.2.2.5.4.13 PolicedDropPkts

This attribute indicates the final value of PolicedDropPkts attribute of the ServiceFlowStats object for the service flow.

7.2.2.5.4.14 PolicedDelayPkts

This attribute indicates the final value of PolicedDelayPkts attribute of the ServiceFlowStats object for the service flow.

7.2.2.5.4.15 Control

This attribute when set to 'destroy' removes this instance from the object. Reading this attribute returns the value 'active'.

7.2.2.5.5 UpChCounterExt Object

This object provides extensions for upstream channel bonding.

References: [MULPIv3.1] Channel Bonding section.

**Table 7-72 - UpChCounterExt Object**

Attribute Name	Type	Access	Type Constraints	Units	Default
IfIndex	InterfaceIndex	key	Interface Index of upstream channel	N/A	N/A
SgmtValid	Counter32	read-only		segments	N/A
SgmtDiscards	Counter32	read-only		segments	N/A

7.2.2.5.5.1 IfIndex

This key represents the interface index of the upstream channel to which this instance applies.



#### 7.2.2.5.5.2 SgmtValid

This attribute contains the number of segments correctly received on the upstream channel. Discontinuities in the value of this counter can occur at reinitialization of the managed system, and at other times as indicated by the value of ifCounterDiscontinuityTime of the associated upstream channel.

References: [MULPIv3.1] Upstream and Downstream Common Aspects section; [RFC 2863].

#### 7.2.2.5.5.3 SgmtDiscards

This attribute represents the total number of discarded segments on this channel due to segment HCS problems. Discontinuities in the value of this counter can occur at reinitialization of the managed system, and at other times as indicated by the value of ifCounterDiscontinuityTime of the associated upstream channel.

References: [MULPIv3.1] Continuous Concatenation and Fragmentation section; [RFC 2863].

#### 7.2.2.5.6 ServiceFlowCcfStats Object

This object provides upstream service flow statistics on upstream fragments for Continuous Concatenation and Fragmentation (CCF). This table will only capture service flow statistics for flows with segment headers set to ON. Any service flow established with segment headers OFF will not be counted in this table and will instead be counted in the normal ServiceFlowStats table. The CMTS MAY choose to not instantiate the ServiceFlowCcfStats object for service flows that do not use CCF or return a zero value for the individual counter statistics.

References: [MULPIv3.1] Continuous Concatenation and Fragmentation section.

**Table 7-73 - ServiceFlowCcfStats Object Attributes**

Attribute Name	Type	Access	Type Constraints	Units	Default
IfIndex	InterfaceIndex	key	Interface Index of MAC Domain interface		
ServiceFlowId	UnsignedInt	key	1..4294967295		
SgmtValid	Counter32	read-only		segments	
SgmtLost	Counter32	read-only		segments	

#### 7.2.2.5.6.1 ServiceFlowCcfStats Object Attributes

##### 7.2.2.5.6.1.1 IfIndex

This key represents the interface index of the upstream channel to which this instance applies.

##### 7.2.2.5.6.1.2 ServiceFlowId

This key represents the Service Flow ID for the service flow.

References: [MULPIv3.1] QoS section.

##### 7.2.2.5.6.1.3 SgmtValid

This attribute contains the number of segments counted on this service flow regardless of whether the fragment was correctly reassembled into valid packets. This attribute only gathers information for Segment Header On service flows. Discontinuities in the value of this counter can occur at reinitialization of the managed system, and at other times as indicated by the value of ifCounterDiscontinuityTime of the associated MAC Domain interface index.

References: [MULPIv3.1] Continuous Concatenation and Fragmentation section; [RFC 2863].

##### 7.2.2.5.6.1.4 SgmtLost

This attribute counts the number of segments which the CMTS segment reassembly function determines were lost. This attribute only gathers information for Segment Header On service flows. Discontinuities in the value of this counter can occur at reinitialization of the managed system, and at other times as indicated by the value of ifCounterDiscontinuityTime of the associated MAC Domain interface index.

References: [MULPIv3.1] Continuous Concatenation and Fragmentation section; [RFC 2863].

#### 7.2.2.5.7 CmtslatcProfileStats Object<sup>136</sup>

This object provides IATC statistics on a per profile basis. The IATC Profile statistics are associated with a DOCSIS channel or bonding group and one or more Service Flows.

The CMTS is not required to persist instances of this object across reinitializations.

References: [MULPIv3.1] IATC Profiles

**Table 7-74 - CmtslatcProfileStats Object Attributes**

Attribute Name	Type	Access	Type Constraints	Units	Default
Name	AdminString	Key		N/A	N/A
IfIndex	UnsignedInt	read-only	Index of channel or bonding group	N/A	N/A
Direction	IfDirection	read-only		N/A	N/A
Pkts	Counter64	read-only		packets	N/A
Octets	Counter64	read-only		bytes	N/A
PolicedDropPkts	Counter64	read-only		packets	N/A
PolicedDelayPkts	Counter64	read-only		packets	N/A

#### 7.2.2.5.7.1 CmtslatcProfileStats Object Attributes

##### 7.2.2.5.7.1.1 Name

This key represents the IATC Profile to which this instance applies.

##### 7.2.2.5.7.1.2 IfIndex

This attribute represents the index, such as the ifIndex, of the DOCSIS channel or the index of the bonding group to which this instance applies.

##### 7.2.2.5.7.1.3 Direction

This attribute indicates the direction to which the IATC Profile is applied.

##### 7.2.2.5.7.1.4 Pkts

This attribute counts the number of Packet Data PDUs forwarded to this IATC Profile.

##### 7.2.2.5.7.1.5 Octets

This attribute counts the number of octets forwarded to this IATC Profile.

##### 7.2.2.5.7.1.6 PolicedDropPkts

This attribute counts the number of dropped Packet Data PDUs classified to this IATC Profile.

##### 7.2.2.5.7.1.7 PolicedDelayPkts

This attribute counts the number of delayed Packet Data PDUs classified to this IATC Profile.

<sup>136</sup> Added per CCAP-OSSv3.1-16.1528-2 on 11/15/16 by KB.

### 7.2.2.5.8 CmtsDebugDsidStats<sup>137</sup>

The CMTS Debug DSID Stats object describes statistics at the CMTS for the forwarding of DSID-labeled downstream packets.

The CMTS creates an instance for every combination of MAC Domain, DSID value, and downstream channel on which packets labeled with that DSID are transmitted. The CMTS MUST NOT delete CmtsDebugDsidStats instances while the corresponding CmtsDebugDsid object control instance exists.

The CMTS MUST NOT persist instances created in the CmtsDebugDsidStats object across reinitializations.

**Table 7-75 - CmtsDebugDsidStats Object**

Attribute Name	Type	Access	Type Constraints	Units	Default
ifIndex	InterfaceIndex	key	Interface Index of MAC Domain interface		
Dsid	Dsid	key	0..1048575		
DsIfIndex	InterfaceIndex	key	InterfaceIndex of downstream channel		
DsidPackets	Counter32	read-only		packets	
DsidOctets	Counter32	read-only		octets	

#### 7.2.2.5.8.1 ifIndex

This key represents the interface index of the MAC Domain to which this instance applies.

#### 7.2.2.5.8.2 Dsid

This key represents the Downstream Service ID (DSID).

#### 7.2.2.5.8.3 DsIfIndex

This key represents an Interface Index of a downstream channel that belongs to the DSID.

#### 7.2.2.5.8.4 DsidPackets

This attribute is a counter which contains the number of packets transmitted by the CMTS which are labeled with the DSID on the downstream channel. Discontinuities in the value of this counter can occur as indicated by the value of ifCounterDiscontinuityTime of the associated Downstream interface index.

#### 7.2.2.5.8.5 DsidOctets

This attribute counts the number of bytes transmitted by the CMTS which are labeled with the DSID on the downstream interface. Discontinuities in the value of this counter can occur as indicated by the value of ifCounterDiscontinuityTime of the associated Downstream interface index.

### 7.2.2.6 SCTE-HMS-MPEG-MIB: Statistics Objects

The objects in the SCTE-HMS-MPEG-MIB: Statistics Objects are taken from [SCTE 154-4] and used with the following modifications for the CCAP.

The CcapMpegOutputProg object replaces the MpegOutputProg object from the SCTE-HMS-MPEG-MIB. It is defined in Section 7.2.1.10.5, CcapMpegOutputProg.

Reference: [SCTE 154-4]

<sup>137</sup> Moved from Section 6 per CCAP-OSSiv3.1-N-16.1433-1 on 5/13/16 by KB.

7.2.2.7 Upstream OFDMA Status Objects<sup>138</sup>

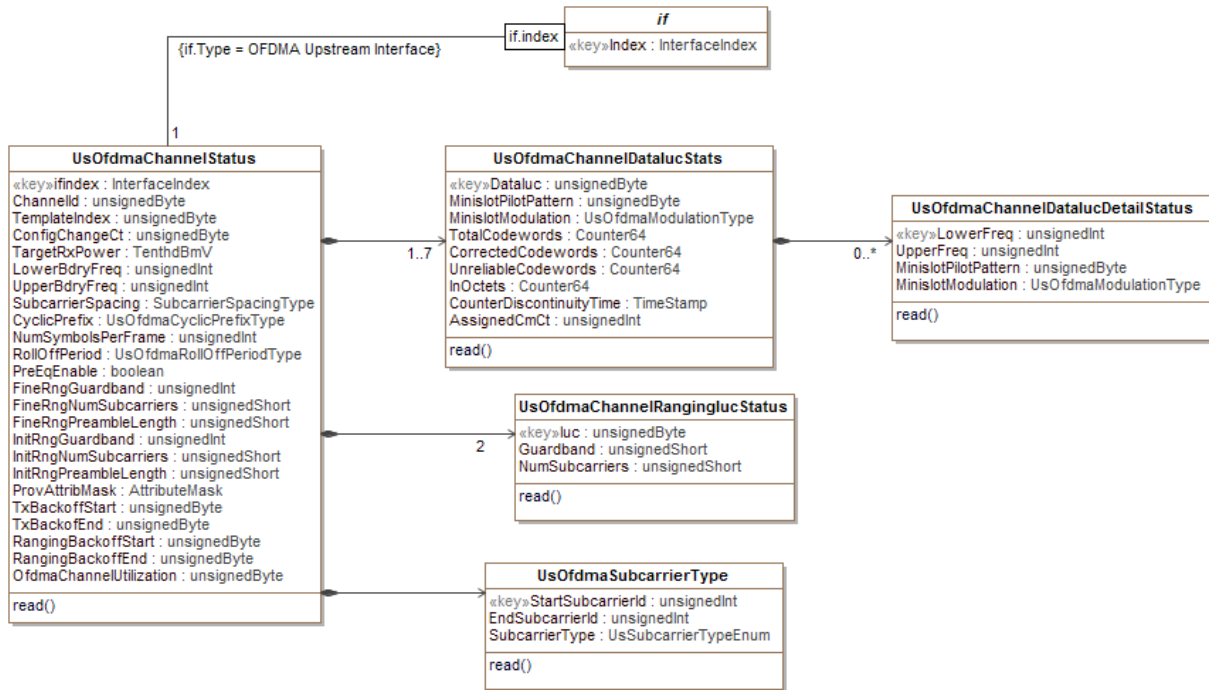

Figure 7-19 - Upstream OFDMA Status Objects<sup>139</sup>

7.2.2.7.1 UsOfdmaChannelStatus object

This object provides information on the CCAP's upstream OFDMA channels.

Table 7-76 - UsOfdmaChannelStatus Object Attributes<sup>140</sup>

Attribute Name	Type	Access	Type Constraints	Units
Ifindex	InterfaceIndex	Key		
ChannelId	UnsignedByte	read-only		
TemplateIndex	UnsignedByte	read-only		
ConfigChangeCt	UnsignedByte	read-only		
TargetRxPower	UnsignedInt	read-only		TenthdBmV
LowerBdryFreq	UnsignedInt	read-only	5000000..197600000	Hz
UpperBdryFreq	UnsignedInt	read-only	11400000..204000000	Hz
SubcarrierSpacing	SubcarrierSpacingType	read-only		
CyclicPrefix	UsOfdmaCyclicPrefixType	read-only		Samples
NumSymbolsPerFrame	UnsignedInt	read-only	6..36	N/A
RollOffPeriod	UsOfdmaWindowingSizeType	read-only		Samples
PreEqEnable	Boolean	read-only		
FineRngGuardband	UnsignedInt	read-only		Hz
FineRngNumSubcarriers	UnsignedShort	read-only	16..512	N/A
FineRngPreambleLength	UnsignedShort	read-only	16..512	Bits

<sup>138</sup> Section and subsections modified by CCAP-OSSv3.1-N-15.1246-2 on 3/5/15 by KB.

<sup>139</sup> Modified per CCAP-OSSv3.1-N-15.1307-3 on 6/1/15 by KB; per CCAP-OSSv3.1-N-15.1376-1 on 11/11/15 by KB; per CCAP-OSSv3.1-N-16.1439-3 on 5/13/16 by KB; per CCAP-OSSv3.1-N-16.1553-1 on 11/16/16 by KB; per CCAP-OSSv3.1-N-16.1686-2 on 12/13/16 by KB.

<sup>140</sup> Modified per CCAP-OSSv3.1-N-15.1307-3 on 6/1/15 by KB; per CCAP-OSSv3.1-N-16.1553-1 on 11/16/16 by KB.

Attribute Name	Type	Access	Type Constraints	Units
InitRngGuardband	UnsignedInt	read-only		Hz
InitRngNumSubcarriers	UnsignedShort	read-only	16..128	N/A
InitRngPreambleLength	UnsignedShort	read-only	16..512	Bits
ProvAttribMask	AttributeMask	read-only		
TxBackoffStart	UnsignedByte	read-only	0..16	power of 2
TxBackoffEnd	UnsignedByte	read-only	0..16	power of 2
RangingBackoffStart	UnsignedByte	read-only	0..16	power of 2
RangingBackoffEnd	UnsignedByte	read-only	0..16	power of 2
OfdmaChannelUtilization	UnsignedByte	read-only	0..100	percent

**Table 7-77 - UsOfdmaChannelStatus Object Associations<sup>141</sup>**

Associated Object Name	Type	Near-end Multiplicity	Far-end Multiplicity	Label
UsOfdmaChannelDataIucStats	Directed Composition		1..7	N/A
UsOfdmaChanRangingIucStatus	Directed Composition		2	N/A
UsOfdmaSubcarrierType	Directed Composition			N/A

#### 7.2.2.7.1.1 UsOfdmaChannelStatus Object Attributes

##### 7.2.2.7.1.1.1 IfIndex

This attribute is the upstream OFDMA channel IfIndex key for the table.

##### 7.2.2.7.1.1.2 ChannelId

This attribute is the upstream Channel Id signaled in the DOCSIS protocol for the OFDMA upstream channel. The Channel Id is unique within the associated MacDomain.

##### 7.2.2.7.1.1.3 TemplateIndex

This attribute is index of the UsOfdmaModulationTemplate object which the CCAP utilized when configuring this channel.

##### 7.2.2.7.1.1.4 ConfigChangeCt<sup>142</sup>

This attribute contains the value of the Configuration Change Count field in the Upstream Channel Descriptor (UCD) MAC Management Message corresponding to this upstream channel.

##### 7.2.2.7.1.1.5 TargetRxPower<sup>143</sup>

This attribute provides the power of the expected commanded received signal in the channel, referenced to the CCAP input. The value represents the power spectral density in an equivalent 1.6 MHz spectrum.

##### 7.2.2.7.1.1.6 LowerBdryFreq

This attribute provides the lower frequency for the US Channel.

##### 7.2.2.7.1.1.7 UpperBdryFreq

This attribute provides the upper frequency for the US Channel.

<sup>141</sup> Table added per CCAP-OSSiv3.1-N-15.1376-1 on 11/11/15 by KB.

<sup>142</sup> Added per CCAP-OSSiv3.1-N-15.1307-3 on 6/1/15 by KB.

<sup>143</sup> Modified per CCAP-OSSiv3.1-N-16.1464-3 on 5/13/16 by KB.

**7.2.2.7.1.1.8 SubcarrierSpacing**

This attribute is the subcarrier spacing for the channel.

**7.2.2.7.1.1.9 CyclicPrefix**

This attribute is the allowed values for applying cyclic prefix for mitigating interference due to microreflections.

**7.2.2.7.1.1.10 NumSymbolsPerFrame**

This attributes represents the number of symbols per frame.

**7.2.2.7.1.1.11 RollOffPeriod**

This attribute provides the allowed values for applying windowing to maximize the capacity of the upstream channel.

Reference: [PHYv3.1] Minislot Structure.

**7.2.2.7.1.1.12 PreEqEnable**

This attribute indicates pre-equalization is enabled on the OFDMA upstream Channel when its value is true, or disabled when its value is false.

**7.2.2.7.1.1.13 FineRngGuardband**

This attribute is the sum of the upper and lower guard bands for fine ranging in Hz.

**7.2.2.7.1.1.14 FineRngNumSubcarriers**

This attribute defines maximum number of subcarriers for fine ranging.

**7.2.2.7.1.1.15 FineRngPreambleLength**

This attribute defines the length of the OFDMA fine ranging IUC preamble.

**7.2.2.7.1.1.16 InitRngGuardband**

This attribute is the sum of the upper and lower guard bands for initial ranging in Hz.

**7.2.2.7.1.1.17 InitRngNumSubcarriers**

This attribute provides the maximum number of subcarriers for initial ranging. This is the maximum number of subcarriers for initial ranging, not including the guard band.

**7.2.2.7.1.1.18 InitRngPreambleLength**

This attribute provides the length of the OFDMA initial ranging IUC preamble.

**7.2.2.7.1.1.19 ProvAttribMask**

This attribute provides the Provisioned Attribute Mask for the OFDMA upstream Channel.

**7.2.2.7.1.1.20 TxBackoffStart**

This attribute provides the initial random back-off window to use when retrying transmissions. Expressed as a power of 2. A configured value of 16 indicates that a proprietary adaptive retry mechanism is to be used.

**7.2.2.7.1.1.21 TxBackoffEnd**

This attribute provides the final random back-off window to use when retrying transmissions. Expressed as a power of 2. A configured value of 16 indicates that a proprietary adaptive retry mechanism is to be used.

#### 7.2.2.7.1.1.22 RangingBackoffStart

This attribute provides the initial random back-off window to use when retrying Ranging Requests. It is expressed as a power of 2. A configured value of 16 indicates that a proprietary adaptive retry mechanism is to be used.

#### 7.2.2.7.1.1.23 RangingBackoffEnd

This attribute represents the final random back-off window to use when retrying Ranging Requests. It is expressed as a power of 2. A configured value of 16 indicates that a proprietary adaptive retry mechanism is to be used.

#### 7.2.2.7.1.1.24 OfdmaChannelUtilization<sup>144</sup>

The introduction of OFDMA channels in DOCSIS 3.1 poses a new scheduling and accounting problem for the CCAP. DOCSIS 3.1 supports simultaneous Time and Frequency Division Multiplexing (TaFDM) between SC-QAM and OFDMA channels. This implies both:

- OFDMA and SC-QAM can simultaneously operate on separate frequencies
- OFDMA and SC-QAM can also operate on the same frequencies, divided in time.

TaFDM scheduling is explained in the Upstream Time and Frequency Multiplexing section of [MULPIv3.1].

When calculating utilization for OFDMA and SC-QAM channels on overlapping frequencies, the CMTS MUST uniquely account spectrum represented by minislots to either an SC-QAM channel or an OFDMA channel. This is required to avoid a situation where available spectrum can be mistakenly accounted as available on both overlapping channels.

This attribute indicates the calculated and truncated utilization for this OFDMA upstream channel, accurate as of the most recent utilization interval.

The upstream channel utilization is expressed as a percentage of minislots utilized on the physical channel, regardless of burst type.

The utilization index calculation can be expressed by the following equation:

$$\text{Utilization} = \text{MinislotsUtilized} / \text{MinislotsAllocated} * 100\%$$

For an Initial Maintenance region, the minislots for the complete region are considered utilized if the CMTS received an upstream burst within the region from any CM on the physical channel. For contention REQ and REQ/DATA regions, the minislots for a transmission opportunity within the region are considered utilized if the CMTS received an upstream burst within the opportunity from any CM on the physical channel. For all other regions, utilized minislots are those in which the CMTS granted bandwidth to any unicast SID on the physical channel.

For an upstream interface that has multiple logical upstream channels enabled, the utilization index is a weighted sum of utilization indices for the logical channels. The weight for each utilization index is the percentage of upstream minislots allocated for the corresponding logical channel.

Example:

If 75% of bandwidth is allocated to the first logical channel and 25% to the second, and the utilization indices for each are 60 and 40, respectively, the utilization index for the upstream physical channel is  $(60 * 0.75) + (40 * 0.25) = 55$ . This figure applies to the most recent utilization interval.

A DOCSIS 3.1 CMTS can operate with upstream OFDMA and SC-QAM channels located on overlapping frequencies. Such scheduling mode is known as Time and Frequency Division Multiplexing (TaFDM). When operating in such mode, the CMTS uniquely allocates minislots to either an SC-QAM channel or an OFDMA channel.

The utilization index for an OFDMA channel is computed by excluding from the calculation those minislots which are effectively allocated to overlapping SC-QAM channels. OFDMA channel minislots dedicated to guard bands and for probes in OFDMA channel are considered utilized. When a SC-QAM channel overlaps in spectrum with an

---

<sup>144</sup> Added per CCAP-OSSiv3.1-N-15.1307-3 on 6/1/15 by KB.

OFDMA channel, its minislots effectively allocated to OFDMA channels are excluded from channel utilization index calculation.

7.2.2.7.2 *UsOfdmaSubcarrierType Object*<sup>145</sup>

This object specifies the subcarrier type for a group of subcarriers in the active spectrum of this OFDMA channel. Groups of subcarriers of the same type are presented together; non-data subcarriers in these ranges are ignored.

**Table 7-78 - UsOfdmaSubcarrierType Object Attributes**

Attribute Name	Type	Access	Type Constraints	Units	Default Value
StartSubcarrierId	unsignedInt	Key			
EndSubcarrierId	unsignedInt	read-only			
SubcarrierType	enum	read-only	data(1), excluded(2), unused(3)		

7.2.2.7.2.1 StartSubcarrierId

This attribute is a key defined to provide an index into the table and represents the subcarrier number of the first subcarrier in the group.

7.2.2.7.2.2 EndSubcarrierId

This attribute is the subcarrier number of the last subcarrier in the group.

7.2.2.7.2.3 SubcarrierType

This attribute specifies which type of subcarrier is represented in this group.

7.2.2.7.3 *UsOfdmaChannelDataIucStats object*<sup>146</sup>

This object provides information on the upstream Profile Data IUCs for an OFDMA channel.

**Table 7-79 - UsOfdmaChannelDataIucStats Object Attributes**<sup>147</sup>

Attribute Name	Type	Access	Type Constraints	Units
DataIuc	UnsignedByte	Key	5 6 9 10 11 12 13	N/A
MinislotPilotPattern	UnsignedByte	read-only		
MinislotModulation	UsOfdmaModulationType	read-only		
TotalCodewords	Counter64	read-only		counts
CorrectedCodewords	Counter64	read-only		counts
UnreliableCodewords	Counter64	read-only		counts
InOctets	Counter64	read-only		bytes
CounterDiscontinuityTime	TimeStamp	read-only		Secs
AssignedCmCt	UnsignedInt	read-only		counts

**Table 7-80 - UsOfdmaChannelDataIucStats Object Associations**<sup>148</sup>

Associated Object Name	Type	Near-end Multiplicity	Far-end Multiplicity	Label
UsOfdmaChannelDataIucDetailStatus	Directed Composition		0..*	N/A

<sup>145</sup> Section added per CCAP-OSSv3.1-N-15.1376-1 on 11/11/15 by KB.

<sup>146</sup> Modified per CCAP-OSSv3.1-N-16.1686-2 on 12/13/16 by KB.

<sup>147</sup> Modified per CCAP-OSSv3.1-N-15.1307-3 on 6/1/15 by KB; per CCAP-OSSv3.1-N-15.1376-1 on 11/11/15 by KB.

<sup>148</sup> Added per CCAP-OSSv3.1-N-15.1376-1 on 11/11/15 by KB.



### 7.2.2.7.3.1 UsOfdmaChannelDataIucStats Object Attributes<sup>149</sup>

#### 7.2.2.7.3.1.1 DataIuc

This attribute represents the OFDMA Data IUC that these statistics correspond to.

#### 7.2.2.7.3.1.2 MinislotPilotPattern<sup>150</sup>

This attribute represents the pilot pattern for the frequency range. All minislots in the frequency range have this pilot pattern.

#### 7.2.2.7.3.1.3 MinislotModulation<sup>151</sup>

This attribute represents the modulation for the frequency range. All minislots in the frequency range have this modulation.

#### 7.2.2.7.3.1.4 TotalCodewords

This attribute contains the count of the total number of FEC codewords received on this channel using this Data IUC.

#### 7.2.2.7.3.1.5 CorrectedCodewords

This attribute contains the count of codewords received on this channel using this Data IUC that failed the pre-decoding syndrome check, but passed the post-decoding syndrome check.

#### 7.2.2.7.3.1.6 UnreliableCodewords

This attribute contains the count of codewords received on this channel using this Data IUC that failed the post-decoding syndrome check.

#### 7.2.2.7.3.1.7 InOctets<sup>152</sup>

This attribute is the count of MAC-layer octets received by the CCAP on this Data IUC. This value is the size of all unicast, multicast or broadcast frames (including all MAC-layer framing) and CCF PMD overhead (segment headers and stuffing bytes) delivered from the PHY to the MAC - this includes user data, DOCSIS MAC Management Messages, etc.

Discontinuities in the value of this counter can occur at reinitialization of the managed system, and at other times as indicated by the value of CounterDiscontinuityTime.

#### 7.2.2.7.3.1.8 CounterDiscontinuityTime

This attribute is the value of sysUpTime on the most recent occasion at which any one or more of this entry's counters suffered a discontinuity. If no such discontinuities have occurred since the last re-initialization of the local management subsystem, then this attribute contains a zero value.

#### 7.2.2.7.3.1.9 AssignedCmCt

This attribute is the count of CMs currently assigned to this Data IUC.

### 7.2.2.7.4 UsOfdmaChannelDataIucDetailStatus

**Table 7-81 - UsOfdmaChannelDataIucDetailStatus Object Attributes**

<sup>149</sup> Some subsections deleted per CCAP-OSSiv3.1-N-15.1376-1 on 11/11/15 by KB.

<sup>150</sup> Added per CCAP-OSSiv3.1-N-15.1307-3 on 6/1/15 by KB.

<sup>151</sup> Added per CCAP-OSSiv3.1-N-15.1307-3 on 6/1/15 by KB.

<sup>152</sup> Modified per CCAP-OSSiv3.1-N-15.1376-1 on 11/11/15 by KB.

Attribute Name	Type	Access	Type Constraints	Units
LowerFreq	UnsignedInt	Key	5000000-204000000	Hz
UpperFreq	UnsignedInt	read-only	5000000-204000000	Hz
MinislotPilotPattern	UnsignedByte	read-only	1..14	
MinislotModulation	UsOfdmaModulationType	read-only		

7.2.2.7.4.1 UsOfdmaChannelDataLucDetailStatus Object Attributes

**7.2.2.7.4.1.1 LowerFreq**

This attribute represents the lower frequency where the minislots will use the pilot pattern and modulation.

**7.2.2.7.4.1.2 UpperFreq**

This attribute represents the upper frequency where the minislots will use the pilot pattern and modulation.

**7.2.2.7.4.1.3 MinislotPilotPattern**

This attribute represents the pilot pattern for the frequency range. All minislots in the frequency range have this pilot pattern.

**7.2.2.7.4.1.4 MinislotModulation**

This attribute represents the modulation for the frequency range. All minislots in the frequency range have this modulation.

7.2.2.7.5 UsOfdmaChannelRangingLucStatus<sup>153</sup>

**Table 7-82 - UsOfdmaChannelDataRangingLucStatus Object Attributes**

Attribute Name	Type	Access	Type Constraints	Units
luc	UnsignedByte	Key		
Guardband	UnsignedShort	read-only		Hz
NumSubcarriers	UnsignedShort	read-only		

7.2.2.7.5.1 UsOfdmaChannelDataRangingLucStatus Object Attributes

**7.2.2.7.5.1.1 IUC**

This attribute provides the Ranging IUC that this row applies to.

**7.2.2.7.5.1.2 Guardband**

This attribute represents the upper frequency where the minislots will use the pilot pattern and modulation.

**7.2.2.7.5.1.3 NumSubcarriers**

This attribute represents the pilot pattern for the frequency range. All minislots in the frequency range have this pilot pattern.

**7.2.2.8 Downstream OFDM Status Objects<sup>154</sup>**

In order for operators to measure the data forwarding performance of their D3.1 DS Channels and make informed DOCSIS capacity planning decisions, the CCAP implements the following management objects.

<sup>153</sup> Modified per CCAP-OSSv3.1-N-16.1439-3 on 5/13/16 by KB.

<sup>154</sup> This section and subsections modified per CCAP-OSSv3.1-N-15.1259-1 on 3/6/15 by KB.

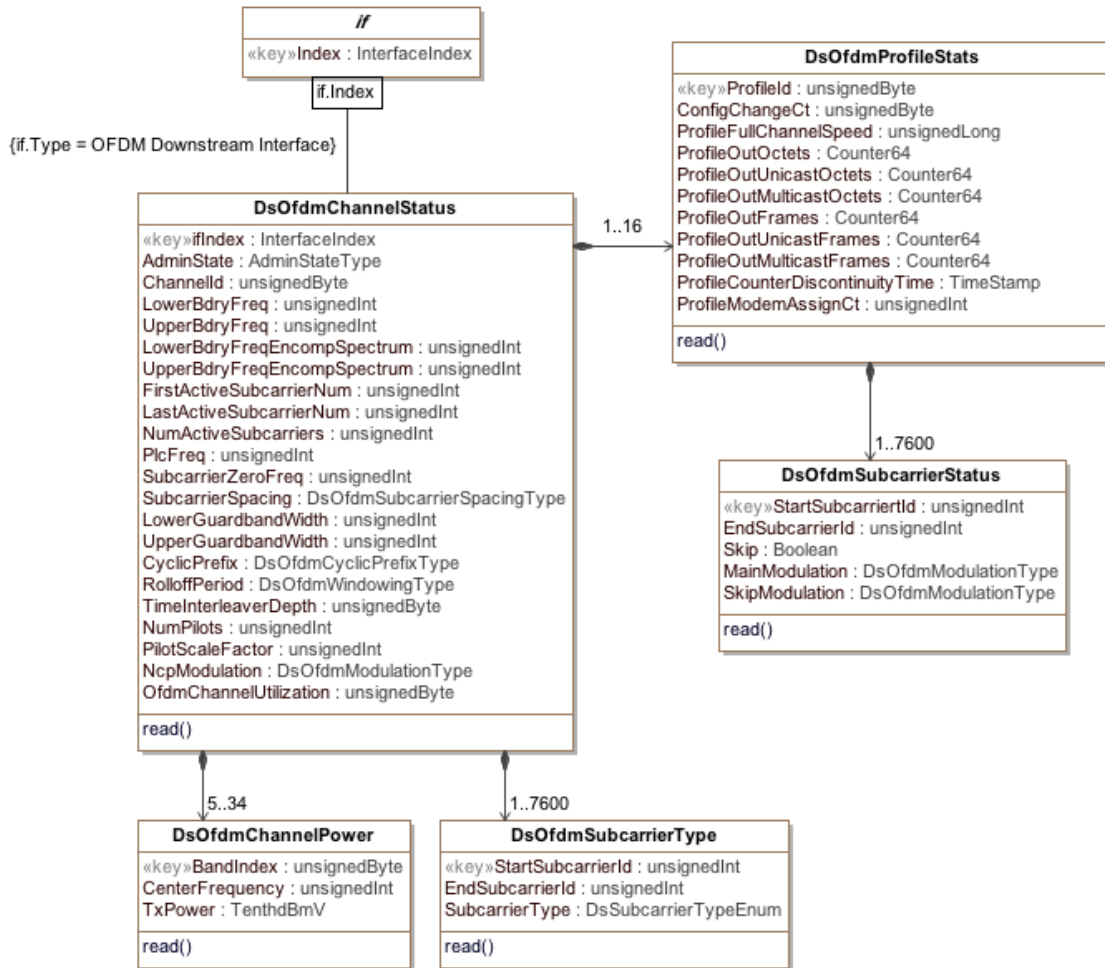

Figure 7-20 - Downstream OFDM Status Objects<sup>155</sup>

7.2.2.8.1 DsOfdmChannelStatus Object

This object specifies the downstream OFDM channel object. There is a 1-to-1 relationship with the OFDM channel CFG object.

Table 7-83 - DsOfdmChannelStatus Object Attributes<sup>156</sup>

Attribute Name	Type	Access	Type Constraints	Units
Ifindex	InterfaceIndex	Key		N/A
AdminState	AdminStatusType	read-only		N/A
ChannelId	UnsignedByte	read-only		N/A
LowerBdryFreq	UnsignedInt	read-only	108000000..1770000000	Hz
UpperBdryFreq	UnsignedInt	read-only	132000000..1794000000	Hz
LowerBdryFreqEncomp Spectrum	UnsignedInt	read-only	108000000..1770000000	Hz

<sup>155</sup> Modified per CCAP-OSSv3.1-N-15.1307-3 on 6/1/15 by KB; per CCAP-OSSv3.1-N-15.1376-1 on 11/11/15 by KB; per CCAP-OSSv3.1-N-16.1440-3 and 16.1493-1 on 5/13/16 by KB; per CCAP-OSSv3.1-N-16.1541-2 on 11/15/16 by KB; per CCAP-OSSv3.1-N-16.1610-2 on 11/17/16 by KB.

<sup>156</sup> Modified per CCAP-OSSv3.1-N-15.1307-3 on 6/1/15 by KB; per CCAP-OSSv3.1-N-15.1376-1 on 11/11/15 by KB; per CCAP-OSSv3.1-N-16.1553-1 on 11/16/16 by KB; per CCAP-OSSv3.1-N-16.1645-2 on 12/8/16 by KB.

Attribute Name	Type	Access	Type Constraints	Units
UpperBdryFreqEncompSpectrum	UnsignedInt	read-only	132000000..1794000000	Hz
FirstActiveSubcarrierNum	UnsignedInt	read-only	148..7895	N/A
LastActiveSubcarrierNum	UnsignedInt	read-only	148..7895	N/A
NumActiveSubcarriers	UnsignedInt	read-only	1..7600	N/A
PlcFreq	UnsignedInt	read-only	108000000..1770000000	Hz
SubcarrierZeroFreq	UnsignedInt	read-only	108000000..1770000000	Hz
SubcarrierSpacing	DsOfdmSubcarrierSpacingType	read-only	N/A	Hz
LowerGuardbandWidth	UnsignedInt	read-only	0   1000000..1770000000	Hz
UpperGuardbandWidth	UnsignedInt	read-only	0   1000000..1770000000	Hz
CyclicPrefix	DsOfdmCyclicPrefixType	read-only	N/A	samples
RolloffPeriod	DsOfdmWindowingType	read-only	N/A	samples
TimeInterleaverDepth	UnsignedByte	read-only	1..32	samples
NumPilots	UnsignedInt	read-only	N/A	N/A
PilotScaleFactor	UnsignedInt	read-only	48..120	
NcpModulation	DsOfdmModulationType	read-only	qpsk(2) qam16(2) qam64(3)	N/A
OfdmChannelUtilization	UnsignedByte	read-only	0..100	%

**Table 7-84 - DsOfdmChannelStatus Object Associations<sup>157</sup>**

Associated Object Name	Type	Near-end Multiplicity	Far-end Multiplicity	Label
DsOfdmProfileStats	Directed Composition		1..16	N/A
DsOfdmChannelPower	Directed Composition		5..34	N/A
DsOfdmSubcarrierType	Directed Composition		1..7600	N/A

7.2.2.8.1.1 IfIndex

This attribute is the unique index of the OFDM Downstream channel. It provides a key into the table.

7.2.2.8.1.2 AdminState

This attribute is the admin state for the OFDM downstream channel.

7.2.2.8.1.3 ChannelId

This attribute is the CMTS identification of the downstream channel within this particular MAC interface.

7.2.2.8.1.4 LowerBdryFreq

This attribute represents either the lower boundary frequency of the lower guardband or (if no guardband is defined) the lower boundary frequency of the lowest active subcarrier of the OFDM downstream channel. It is intended to be aligned with the boundaries of the SC-QAM channels on defined channel frequency HFC plants.

7.2.2.8.1.5 UpperBdryFreq

This attribute represents either the upper boundary frequency of the upper guardband or (if no guardband is defined) the upper boundary frequency of the highest active subcarrier of the OFDM downstream channel. It is intended to be aligned with the boundaries of the SC-QAM channels on defined channel frequency HFC plants.

7.2.2.8.1.6 LowerBdryFreqEncompSpectrum

This attribute represents the lower boundary frequency of the encompassed spectrum.

<sup>157</sup> Modified per CCAP-OSSv3.1-N-15.1307-3 on 6/1/15 by KB; per CCAP-OSSv3.1-N-15.1376-1 on 11/11/15 by KB; per CCAP-OSSv3.1-N-16.1440-3 on 5/13/16 by KB.

#### 7.2.2.8.1.7 UpperBdryFreqEncompSpectrum

This attribute represents the upper boundary frequency of the encompassed spectrum.

#### 7.2.2.8.1.8 PlcFreq

This attribute is the PHY Link Channel (PLC) frequency. It is the center frequency of the lowest subcarrier of the 6 MHz encompassed spectrum containing the PLC at its center. The frequency of this subcarrier is required to be located on a 1 MHz grid. The aim of the PLC is for the CMTS to convey to the CM the physical properties of the OFDM channel.

#### 7.2.2.8.1.9 FirstActiveSubcarrierNum

This attribute corresponds to the number of the first non-excluded subcarrier.

#### 7.2.2.8.1.10 LastActiveSubcarrierNum

This attribute corresponds to the number of the last non-excluded subcarrier.

#### 7.2.2.8.1.11 NumActiveSubcarriers

This attribute defines the number of active subcarriers within the OFDM downstream channel. For 4K FFT mode, the maximum number of contiguous active subcarriers cannot exceed 3800 and for 8K FFT mode, this number cannot be greater than 7600.

Note: this excludes continuous pilots and the PLC.

#### 7.2.2.8.1.12 SubcarrierZeroFreq<sup>158</sup>

This attribute specifies the center frequency of subcarrier 0 of the OFDM channel. This is the frequency of subcarrier X(0) in the definition of the Discrete Fourier Transform.

#### 7.2.2.8.1.13 SubcarrierSpacing

This attribute is the subcarrier spacing in use on the OFDM downstream channel.

#### 7.2.2.8.1.14 LowerGuardbandWidth

This optional attribute defines the width in Hertz of the lower guard band of the OFDM channel. If omitted, the width of the lower guard band will be automatically configured by the CCAP.

#### 7.2.2.8.1.15 UpperGuardbandWidth

This optional attribute defines the width in Hertz of the upper guard band of the OFDM channel. If omitted, the width of the upper guard band will be automatically configured by the CCAP.

#### 7.2.2.8.1.16 CyclicPrefix

This attribute specifies the cyclic prefix, which enables the receiver to overcome the effects of inter-symbol-interference and intercarrier-interference caused by micro-reflections in the channel. There are five possible values for the length of the CP and the choice depends on the delay spread of the channel - a longer delay spread requires a longer cyclic prefix. The cyclic prefix (in  $\mu\text{s}$ ) are converted into samples using the sample rate of 204.8 Msamples/s and is an integer multiple of:  $1/64 * 20 \mu\text{s}$ .

#### 7.2.2.8.1.17 RolloffPeriod

This attribute specifies the roll off period or windowing, which maximizes channel capacity by sharpening the edges of the spectrum of the OFDM signal. For windowing purposes another segment at the start of the IDFT output is appended to the end of the IDFT output -the roll-off postfix (RP). There are five possible values for the (RP), and

---

<sup>158</sup> Section modified per CCAP-OSSiv3.1-N-14.1229-1 on 2/17/15 by kb.

the choice depends on the bandwidth of the channel and the number of exclusion bands within the channel. A larger RP provides sharper edges in the spectrum of the OFDM signal; however, there is a time vs. frequency trade-off. Larger RP values reduce the efficiency of transmission in the time domain, but because the spectral edges are sharper, more useful subcarriers appear in the frequency domain. There is an optimum value for the RP that maximizes capacity for a given bandwidth and/or exclusion band scenario.

#### 7.2.2.8.1.18 TimeInterleaverDepth

This attribute specifies the number of samples for the OFDM Downstream channel. This is limited to 16 samples for and 32 samples for 50 kHz and 25 kHz Subcarrier Spacing, respectively.

#### 7.2.2.8.1.19 NumPilots

This attribute is the number of continuous pilots for the downstream channel.

#### 7.2.2.8.1.20 PilotScaleFactor<sup>159</sup>

This attribute represents the scale factor for calculating the number of continuous pilots.

#### 7.2.2.8.1.21 NcpModulation<sup>160</sup>

This attribute represents the modulation of all subcarriers in the NCP channel.

#### 7.2.2.8.1.22 OfdmChannelUtilization<sup>161</sup>

This attribute is the DS OFDM channel utilization measured by the CCAP across all profiles over the configured utilization interval.

The CCAP MUST report DS utilization metric of the channel that conforms to the following requirements:

- The CCAP MUST report a value for OfdmChannelUtilization  $\leq 1\%$  when no user traffic is forwarded on the channel and MMM traffic is known to be less than 1% of the channel capacity.
- The CCAP MUST report a value for OfdmChannelUtilization  $\geq 99\%$  when forwarded traffic completely saturates the channel.
- The CCAP MUST report a value for OfdmChannelUtilization which increases linearly with traffic volume increase and is accurate within 1% of the channel capacity<sup>162</sup> for any given traffic mix (ratio of packets for a given OFDM profiles, packet size, traffic pattern, etc.) which results in nearly all full codewords as the maximum channel capacity is reached.

The following algorithm is the reference algorithm for calculating OfdmChannelUtilization:

```
chanWeightedByteTotal = 0;

//ProfileFullChannelSpeed is defined in Section 7.2.2.8.4.3
mostEffProfileSpeed = max(ProfileFullChannelSpeed across all profiles);

//ProfileOutOctets is the number of octets sent on a given profile during
//the utilization interval. This implies a delta calc on a continuous ctr.
//utilInterval is the duration of the utilization interval in seconds.

for (i = 0; i < numProfiles; i++)
{
    profileMultiplier = mostEffProfileSpeed / ProfileFullChannelSpeed[i];
    chanWeightedByteTotal += profileMultiplier * ProfileOutOctets[i];
}
```

<sup>159</sup> Added per CCAP-OSSv3.1-N-15.1307-3 on 6/1/15 by KB.

<sup>160</sup> Modified per CCAP-OSSv3.1-N-15.1307-3 on 6/1/15 by KB.

<sup>161</sup> Modified per CCAP-OSSv3.1-N-15.1389-2 on 11/10/15 by KB.

<sup>162</sup> The channel capacity is defined as the largest ProfileFullChannelSpeed value for this channel.

```
OfdmChannelUtilization = (8 * chanWeightedByteTotal) /
    (mostEffProfileSpeed * utilInterval);
```

The reference algorithm is expected to give an excellent (within a fraction of 1%) representation of actual channel capacity and utilization under most real-world operating conditions. However, it should be recognized that the accuracy of this approach might be compromised in the event of one or more of the following:

- Large number of profiles in the system relative to total channel capacity
- Aggressive latency targets
- Imbalance in traffic loading across profiles (i.e., many very-lightly-loaded profiles and few more heavily loaded profiles)

These conditions could force the codeword builder to shorten codewords in order to serve all active profiles within the limited time/bandwidth dictated by the latency targets and channel capacity. The resulting additional overhead represents a loss of total capacity not accounted for in the reference algorithm, meaning that the actual utilization will be slightly higher than the utilization reported by the reference algorithm.

The Codeword Builder Latency table of [MULPIv3.1] offers guidance regarding the relationship between number of profiles, channel bandwidth, and latency targets. In a system configured at the edges of these bounds, the error of the reference algorithm is expected to be no more than 2-3% under worst-case conditions of traffic imbalance; the effects of averaging over the utilization interval will typically reduce this error significantly.

Codeword builder algorithms, including codeword-shortening decisions, are vendor-specific. A vendor might choose to incorporate proprietary information about the codeword builder algorithm into the calculation of OfdmChannelUtilization in order to account for some or all of the capacity loss described above.

In a simplified case of a single profile with moderate-to-heavy loading, codeword builder implementations are expected to provide capacity and report utilization values which are extremely close to those given by the reference algorithm.

#### 7.2.2.8.2 *DsOfdmChannelPower Object*<sup>163</sup>

This object provides the attributes to measure the downstream OFDM channel power in 6 MHz-wide bands at the output of the CCAP.

**Table 7-85 - DsOfdmChannelPower Object Attributes**

Attribute Name	Type	Access	Type Constraints	Units	Default Value
BandIndex	UnsignedByte	Key	0..33		
CenterFrequency	UnsignedLong	R/O	111000000..1215000000	Hz	0
TxPower	TenthdBmV	R/O		dBmV	

##### 7.2.2.8.2.1 BandIndex

This attribute is a unique index used by the CCAP to identify each of the 6 MHz bands of a given OFDM downstream channel (from the lowest 6 MHz band of the Occupied Bandwidth to the highest 6 MHz band of the Occupied Bandwidth). The CCAP MUST assign indices in frequency order from the OFDM channel's lowest to highest 6 MHz frequency band for each of the 6 MHz bands of the channel, using an index of 1 to represent the lowest frequency band of the Occupied Bandwidth. Thus, an index of 33 represents the highest possible 6 MHz frequency band of the Occupied Bandwidth of an OFDM channel. The CCAP MUST also provide the power of the PLC channel and utilize a value of 0 to represent the PLC channel in this table.

<sup>163</sup> Added per CCAP-OSSiv3.1-N-15.1307-3 on 6/1/15 by KB.

7.2.2.8.2.2 CenterFrequency

This attribute corresponds to the center frequency of the 6 MHz band where the CCAP measured the average channel power. The 6 MHz measurement band is defined as any 6 MHz band with a center frequency of 111 + 6 (n-1) MHz for n = 1,2...185 (i.e., 111,117,...1215 MHz).

The CCAP MUST use a center frequency with a value of 0 for the 6 MHz encompassed spectrum containing the PLC at its center.

The CCAP MUST provide the center frequency for the 6 MHz channel, other than the one encompassing the PLC channel, per the following formula: centerfreq = 111 + 6(n-1), such that (centerfreq - 111) / 6, must be a whole number.

7.2.2.8.2.3 TxPower

This attribute provides an estimate of the average power measured at the output of the CCAP in the downstream channel set for any 6 MHz bandwidth with the Center Frequency of 111 + 6(n-1) MHz for n =1,2,...185 (i.e., 111,117,...1215 MHz).

If the BandIndex is 0, then this attribute provides an estimate of the average power measured at the output of the CCAP for a 6 MHz encompassed spectrum containing the DOCSIS 3.1 PLC at its center.

7.2.2.8.3 DsOfdmSubcarrierType Object<sup>164</sup>

This object specifies the subcarrier type for a group of subcarriers in the active spectrum of this OFDM channel. Groups of subcarriers of the same type are presented together; non-data subcarriers in these ranges are ignored.

**Table 7-86- DsOfdmSubcarrierType Object Attributes**

Attribute Name	Type	Access	Type Constraints	Units	Default Value
StartSubcarrierId	unsignedInt	Key			
EndSubcarrierId	unsignedInt	read-only			
SubcarrierType	enum	read-only	data(1), plc(2), continuousPilot(3), excluded(4)		

7.2.2.8.3.1 StartSubcarrierId

This attribute is a key defined to provide an index into the table and represents the subcarrier number of the first subcarrier in the group.

7.2.2.8.3.2 EndSubcarrierId

This attribute is the subcarrier number of the last subcarrier in the group.

7.2.2.8.3.3 SubcarrierType

This attribute specifies which type of subcarrier is represented in this group.

7.2.2.8.4 DsOfdmProfileStats Object<sup>165</sup>

This object defines the downstream OFDM Profile usage object.

All attributes in this object count MAC-layer octets and frames delivered from the MAC to the Phy. The octet counters include all MAC-layer overhead (e.g., DOCSIS and Ethernet MAC framing as well as DOCSIS MAC Management Messages), but not Physical-layer overhead (e.g., FEC overhead, NCP overhead, etc.). These counters

<sup>164</sup> Added per CCAP-OSSv3.1-N-15.1376-1 on 11/11/15 by KB.

<sup>165</sup> TotalCodewords subsections deleted per CCAP-OSSv3.1-N-15.1376-1 on 11/11/15 by KB; per CCAP-OSSv3.1-N-16.1541-2 on 11/15/16 b KB.



vary by the destination MAC address of the frame. Unicast counters only include frames with a unicast MAC destination address (but include both unicast data frames and unicast MMMs). Multicast counters only include frames with a multicast MAC destination address (including multicast data frames and multicast MMMs, but excluding any frames sent to a broadcast MAC address). The broadcast octet count can be calculated by subtracting unicast octets and multicast octets from the total octets. The broadcast frame count can be calculated similarly.

**Table 7-87 - DsOfdmProfileStats Object Attributes<sup>166</sup>**

Attribute Name	Type	Access	Type Constraints	Units
ProfileId	unsignedByte	Key	0..15	N/A
ConfigChangeCt	unsignedByte	read-only		
ProfileFullChannelSpeed	unsignedLong	read-only		bps
ProfileOutOctets	Counter64	read-only		bytes
ProfileOutUnicastOctets	Counter64	read-only		bytes
ProfileOutMulticastOctets	Counter64	read-only		bytes
ProfileOutFrames	Counter64	read-only		counts
ProfileOutUnicastFrames	Counter64	read-only		counts
ProfileOutMulticastFrames	Counter64	read-only		counts
ProfileCounterDiscontinuityTime	TimeStamp	read-only		secs
ProfileAssignedCmCt	unsignedInt	read-only		counts

**Table 7-88 - DsOfdmProfileStats Object Associations**

Associated Object Name	Type	Near-end Multiplicity	Far-end Multiplicity	Label
DsOfdmSubcarrierStatus	Directed Composition		1..7600	N/A
DsOfdmChannelStatus	Directed Composition	1..16		

#### 7.2.2.8.4.1 ProfileId

This attribute is a unique index and is the identifier of the downstream profile associated with the OFDM downstream channel. The value of this key attribute is zero-based due to constraints of the definition of ProfileId.

Reference: [MULPIv3.1] Downstream Profile Descriptor (DPD) section

#### 7.2.2.8.4.2 ConfigChangeCt<sup>167</sup>

This attribute contains the value of the Configuration Change Count field in the Downstream Profile Descriptor (DPD) MAC Management Message corresponding to this profile.

#### 7.2.2.8.4.3 ProfileFullChannelSpeed<sup>168</sup>

This attribute is the speed of the associated channel in bps if this were the only profile and 100% of data-capable subcarriers were utilized to transmit MAC frames in full codewords. ProfileFullChannelSpeed is intended to approximate the maximum speed available to the MAC layer; thus, this attribute subtracts out FEC and NCP overhead from the maximum theoretical speed. The maximum ProfileFullChannelSpeed for a given channel differs from the ifSpeed for the channel by the amount of this FEC and NCP overhead. The CCAP SHOULD calculate ProfileFullChannelSpeed such that the result is equal to that calculated by the following algorithm or its equivalent:

```
def profileFullChanSpeed(encompSpec, subcarSpac, contPilots, cycPref, excBW,
    avgBitLoad, ncpBitLoad):
    #encompSpec -- encompassed spectrum in MHz
    #subcarSpac -- subcarrier spacing in KHz; 25 or 50 are valid for D3.1
```

<sup>166</sup> Modified per CCAP-OSSiv3.1-N-15.1307-3 on 6/1/15 by KB; per CCAP-OSSiv3.1-N-15.1376-1 on 11/11/15 by KB; per CCAP-OSSiv3.1-N-16.1493-2 on 5/13/16 by KB; per CCAP-OSSiv3.1-N-16.1507-1 on 5/16/16 by KB.

<sup>167</sup> Added per CCAP-OSSiv3.1-N-15.1307-3 on 6/1/15 by KB.

<sup>168</sup> Modified per CCAP-OSSiv3.1-N-15.1389-2 on 11/10/15 by KB.

```

#contPilots -- number of continuous pilots
#cycPref -- cyclic prefix in usec
#excBW -- exclusion bandwidth in MHz
#avgBitLoad -- average bits/subcarrier/symbol for all data subcarriers
#ncpBitLoad -- bits/subcarrier/symbol for NCP subcarriers

if subcarSpac == 25:
    plcSC = 16
elif subcarSpac == 50:
    plcSC = 8
else:
    return error

symbolSize = 1.0 / (subcarSpac * 1000.0)
totSymDuration = symbolSize + (cycPref / 1000000.0)
symbolRate = 1.0 / totSymDuration

numSC = (encompSpec * 1000000.0) * symbolSize
excSC = ceil(excBW / subcarSpac)
usableSC = numSC - plcSC - contPilots - excSC

rawBitsPerSym = usableSC * avgBitLoad
scatPilotFactor = 127.0/128.0 #constant (approximation)
preNcpBitsPerSym = rawBitsPerSym * scatPilotFactor

bitsPerFullCw = 16200 #constant
firstPassFullCwPerSym = preNcpBitsPerSym / bitsPerFullCw

ncpScCeil = (48/ncpBitLoad) * (ceil(firstPassFullCwPerSym) + 1)
ncpScFloor = (48/ncpBitLoad) * max(2, floor(firstPassFullCwPerSym) + 1)
fpFullCwPerSymFrac = firstPassFullCwPerSym - floor(firstPassFullCwPerSym)
interpAvgNcpSC = ncpScFloor + (ncpScCeil - ncpScFloor) * fpFullCwPerSymFrac

postNcpAvgNumDataSC = usableSC - interpAvgNcpSC
postNcpAvgBitsPerSym = postNcpAvgNumDataSC * avgBitLoad * scatPilotFactor

#MAC-layer bits per full codeword / full codeword total bits (constant)
fecEfficiencyMacData = 14216.0 / 16200.0 #~87.75%
macLayerAvgBitsPerSym = postNcpAvgBitsPerSym * fecEfficiencyMacData

profFullChanSpeed = macLayerAvgBitsPerSym * symbolRate

return profFullChanSpeed

```

#### 7.2.2.8.4.4 ProfileOutOctets

This attribute is the count of MAC-layer octets transmitted by the CCAP using this profile. This value is the size of all unicast, multicast or broadcast frames (including all MAC-layer framing) delivered from the MAC to the PHY - this includes user data, DOCSIS MAC Management Messages, etc.

Discontinuities in the value of this counter can occur at reinitialization of the managed system, and at other times as indicated by the value of ProfileCounterDiscontinuityTime.

#### 7.2.2.8.4.5 ProfileOutUnicastOctets<sup>169</sup>

This attribute is the count of MAC-layer Unicast octets transmitted by the CCAP using this profile. This value is the size of all unicast frames (including all MAC-layer framing) delivered from the MAC to the PHY - this includes user data, DOCSIS MAC Management Messages, etc.

Discontinuities in the value of this counter can occur at reinitialization of the managed system, and at other times as indicated by the value of ProfileCounterDiscontinuityTime.

<sup>169</sup> Modified per CCAP-OSSiv3.1-N-15.1376-1 on 11/11/15 by KB.

#### 7.2.2.8.4.6 ProfileOutMulticastOctets<sup>170</sup>

This attribute is the count of MAC-layer Multicast and broadcast octets transmitted by the CCAP using this profile. This value is the size of all frames (including all MAC-layer framing) delivered from the MAC to the PHY and addressed to a multicast MAC address - this includes user data, DOCSIS MAC Management Messages, etc.

Discontinuities in the value of this counter can occur at reinitialization of the managed system, and at other times as indicated by the value of ProfileCounterDiscontinuityTime.

#### 7.2.2.8.4.7 ProfileOutFrames

This attribute is the count of frames transmitted by the CCAP using this profile. This value is the count of all unicast, multicast or broadcast frames delivered from the MAC to the PHY - this includes user data, DOCSIS MAC Management Messages, etc.

Discontinuities in the value of this counter can occur at reinitialization of the managed system, and at other times as indicated by the value of ProfileCounterDiscontinuityTime.

#### 7.2.2.8.4.8 ProfileOutUnicastFrames

This attribute is the count of unicast frames transmitted by the CCAP using this profile. This value is the count of all frames delivered from the MAC to the PHY and addressed to a unicast MAC address - this includes user data, DOCSIS MAC Management Messages, etc.

Discontinuities in the value of this counter can occur at reinitialization of the managed system, and at other times as indicated by the value of ProfileCounterDiscontinuityTime.

#### 7.2.2.8.4.9 ProfileOutMulticastFrames

This attribute is the count of multicast frames transmitted by the CCAP using this profile. This value is the count of all frames delivered from the MAC to the PHY and addressed to a multicast MAC address - this includes user data, DOCSIS MAC Management Messages, etc., but excludes frames sent to a broadcast address.

Discontinuities in the value of this counter can occur at reinitialization of the managed system, and at other times as indicated by the value of ProfileCounterDiscontinuityTime.

#### 7.2.2.8.4.10 ProfileCounterDiscontinuityTime

This attribute is the value of sysUpTime on the most recent occasion at which any one or more of this entry's counters suffered a discontinuity. If no such discontinuities have occurred since the last re-initialization of the local management subsystem, then this attribute contains a zero value.

#### 7.2.2.8.4.11 ProfileAssignedCmCt<sup>171</sup>

This attribute is the count of CMs currently assigned to this profile.

#### 7.2.2.8.5 DsOfdmSubcarrierStatus Object<sup>172</sup>

This object represents a consecutive range of active subcarriers with the same modulation for the parent profile and OFDM channel.

**Table 7-89 - DsOfdmSubcarrierStatus Object Attributes<sup>173</sup>**

Attribute Name	Type	Access	Type Constraints	Units
StartSubcarrierId	UnsignedInt	Key		
EndSubcarrierId	UnsignedInt	read-only		

<sup>170</sup> Modified per CCAP-OSSiv3.1-N-15.1376-1 on 11/11/15 by KB.

<sup>171</sup> Added per CCAP-OSSiv3.1-N-16.1507-1 on 5/16/16 by KB.

<sup>172</sup> Several subsections modified or deleted per CCAP-OSSiv3.1-N-15.1376-1 on 11/11/15 by KB; per CCAP-OSSiv3.1-N-16.1610-2 on 11/17/16 by KB.

<sup>173</sup> Modified per CCAP-OSSiv3.1-N-15.1376-1 on 11/11/15 by KB.

Attribute Name	Type	Access	Type Constraints	Units
Skip	Boolean	read-only		
MainModulation	DsOfdmModulationType	read-only		
SkipModulation	DsOfdmModulationType	read-only		

7.2.2.8.5.1 StartSubcarrierId

This attribute is a key defined to provide an index into the table and represents an identifier for the first subcarrier in the range of active subcarriers with the same modulation.

7.2.2.8.5.2 EndSubcarrierId

This attribute is the subcarrier number of the last subcarrier in the group.

7.2.2.8.5.3 Skip

This attribute indicates whether the skip modulation method is used. If true, the modulation order of the subcarriers in the range is alternating between the MainModulation and SkipModulation.

7.2.2.8.5.4 MainModulation

This attribute indicates the main modulation order of the subcarriers in the range. In case of skip modulation enabled, the MainModulation is the modulation order of the first, the third, the fifth, etc., subcarriers in the range.

7.2.2.8.5.5 SkipModulation

This attribute indicates the modulation order for every other subcarrier in the range.

7.2.2.9 DOCS-IF3-MIB: Statistical Objects<sup>174</sup>

The objects in the DOCS-IF3-MIB statistical performance management class diagram are taken from the following DOCSIS MIBs and are used without modification for the CCAP:

Object	MIB
SignalQualityExt	DOCS-IF3-MIB

Reference: [OSSv3.0], [DOCS-IF3-MIB]

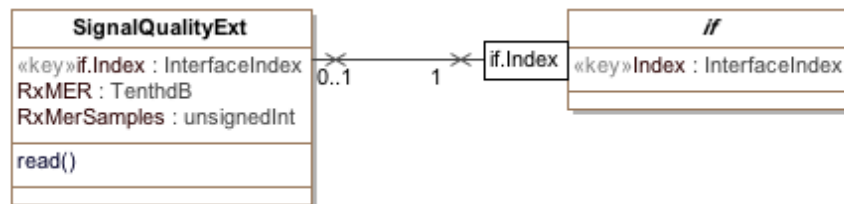

Figure 7-21 - DOCS-IF3-MIB Statistical Performance Management Information Model

7.2.2.9.1 SignalQualityExt

This object provides an in-channel received modulation error ratio metric for the CMTS and CCAP.

<sup>174</sup> Added per CCAP-OSSv3.1-N-16.1433-1 on 5/13/16 by KB.

**Table 7-90 - SignalQualityExt Object**

Attribute Name	Type	Access	Type Constraints	Units	Default
lfIndex	InterfaceIndex	key	Interface Index of logical upstream channel		
RxMER	TenthdB	read-only	-2147483648..2147483647	TenthdB	
RxMerSamples	unsignedInt	read-only			

#### 7.2.2.9.1.1 lfIndex

This key represents the interface index of the logical upstream channel for the CMTS to which this instance applies.

#### 7.2.2.9.1.2 RxMER

RxMER provides an in-channel received Modulation Error Ratio (MER). RxMER is defined as an estimate, provided by the demodulator, of the ratio:

(average constellation energy with equally likely symbols) / (average squared magnitude of error vector)

RxMER is measured just prior to FEC (trellis/Reed-Solomon) decoding. RxMER includes the effects of the HFC channel as well as implementation effects of the modulator and demodulator. Error vector estimation may vary among demodulator implementations. The CMTS RxMER is averaged over a given number of bursts at the burst receiver, which may correspond to transmissions from multiple users. In the case of S-CDMA mode, RxMER is measured on the de-spread signal.

#### 7.2.2.9.1.3 RxMerSamples

RxMerSamples is a statistically significant number of bursts for the CMTS, processed to arrive at the RxMER value. For the CMTS, the MER measurement includes only valid bursts that are not in contention regions.

## 7.3 Proactive Network Maintenance Object Model

### 7.3.1 Overview<sup>175</sup>

This section defines the CCAP object models supporting Proactive Network Maintenance (PNM). CCAP and cable modem features and capabilities can be leveraged to enable measurement and reporting of network conditions such that undesired impacts such as plant equipment and cable faults, interference from other systems and ingress can be detected and measured. With this information cable network operations personnel can make modifications necessary to improve conditions and monitor network trends to detect when network improvements are needed.

DOCSIS 3.1 PNM capability assumes the existence of a PNM server that initiates PNM tests and receives data output from the CM and/or from the CCAP. While most tests defined in this section will complete in a short time frame, some tests will collect data over extended periods. There are also tests that can be triggered on the CM that do not require any CCAP interaction. It is possible that while a test is in progress, the CCAP could command the CM to be load balanced. In these cases, the test will abort on the CM. On the CCAP, if a test (like the DS Symbol Capture) is running for a given CM, the CCAP SHOULD prevent load balancing or other DS channel changes for that CM. Operators that wish to collect long term tests on a given modem can place the modem in the Load Balance exception table to prevent future load balance attempts on that CM which might cause the testing to abort.

Any discontinuities in the channel (channel is reset or the channel is administratively taken down or removed from service) will result in any tests associated with that interface to be concluded or aborted.

### 7.3.2 Data Type Definitions<sup>176</sup>

This section defines the management model for the PNM Downstream Parameters Object Model. This information is contained in [PHYv3.1]: “Proactive Network Maintenance”.

<sup>175</sup> This section and subsections modified by CCAP-OSSiv3.1-N-15.1250-2 on 3/3/15 by KB.

<sup>176</sup> This section and subsections modified by CCAP-OSSiv3.1-N-15.1250-2 on 3/3/15 by KB.

**Table 7-91 - Data Types<sup>177</sup>**

Data Type Name	Base Type	Permitted Values	Reference
ComplexData	hexBinary		
MeasStatusType	enum	other(1) inactive(2) busy(3) sampleReady(4) error(5) resourceUnavailable(6) sampleTruncated(7)	
ExclSubCarrierType	hexBinary		
ImpulseNoiseEventType	hexBinary		
RxMERData	hexBinary		

### 7.3.2.1 ComplexDataType<sup>178</sup>

This data type uses 16-bit fixed-point, fractional, twos-complement notation to represent each of the I (real) and Q (imaginary) components of a complex number. When viewed as a 32-bit number in a file, the I component is the most significant 16 bits and the Q component is the least significant 16 bits. Positive or negative input values exceeding the number format are clipped on I and Q independently (no rollover).

The fixed point format uses “sm.n” notation to indicate the location of the binary point in the I and Q components. Reading from left to right there is a sign bit, m integer bits, the assumed location of the binary point, and n fractional bits. If the I or Q components have less than 16 available bits of input data, the binary point of the input data is adjusted to match the sm.n specification in the 16-bit field, with the MSBs sign-filled if required, and the LSBs zero-filled if required.

Examples of sm.n notation: With s1.14 format, the numerical value "1" corresponds to hex pattern 0x4000. With s2.13 format, the numerical value "1" corresponds to 0x2000. With s3.12 format, the numerical value "1" corresponds to 0x1000.

Example of a complex number with s2.13 format on I and Q components: 0x2400F800 represents the complex number 1.125 - 0.25 j, where “j” is the square root of -1; that is, I = 1.125 and Q = -0.25.

### 7.3.2.2 MeasStatusType

This data type is used to determine the state of a measurement. The MeasStatusTypes are interpreted as follows:

- ‘other’ - Indicates any state not described below
- ‘inactive’ - Indicates that a test is not started or in progress
- ‘busy’ - Indicates that a test has been started and is in progress
- ‘sampleReady’ - Indicates that a test has completed and that the measurement data is ready
- ‘error’ - Indicates that there was an error starting or during the test and any test data, if available, may not be valid
- ‘resourceUnavailable’ - Indicates that the test could not be started due to lack of test platform resources
- ‘sampleTruncated’ - Indicates that the size of the requested data exceeded file size supported

<sup>177</sup> Modified per CCAP-OSSiv3.1-N-15.1307-3 on 6/1/15 by KB.

<sup>178</sup> Modified per CCAP-OSSiv3.1-N-15.1307-3 on 6/1/15 by KB; per CCAP-OSSiv3.1-N-15.1364-1 on 11/10/15 by KB.

### 7.3.2.3 *ExclSubCarrierType*

This data type is used to represent subcarriers which are excluded. The length in bytes of this data type is equal to the FFT size divided by 8. Each bit corresponds to a subcarrier. If a bit is set, then the subcarrier is excluded. The left most bit of the first byte corresponds to the lowest frequency subcarrier. The right most bit of the last byte corresponds to highest frequency subcarrier.

### 7.3.2.4 *ImpulseNoiseEventType*<sup>179</sup>

This data type is used to represent Impulse Noise events. The length in bytes of this data type is 12 bytes structured as follows:

**Table 7-92 - Format for ImpulseNoiseEventType**

Element	Type	Units	Size
Timestamp	UnsignedLong		8 bytes
Event Duration	UnsignedInt	ns	4 bytes
EventAveragePower	Short	dBmV	2 bytes

#### 7.3.2.4.1 *Timestamp*

Timestamp is the 64-bit Extended Timestamp. If the CMTS is not using the 64-bit Extended Timestamp, then the 8-byte value is constructed from the 32-bit DOCSIS 3.0 Timestamp as follows:

Bits 63 through 41 = 0

Bits 40 through 9 = 32-bit DOCSIS 3.0 Timestamp

Bits 8 through 0 = 0

#### 7.3.2.4.2 *EventDuration*

The event duration is the period of time during which the signal level exceeded the StartTriggerLevel and until the signal level fell below the EndTriggerLevel. If the capture is done using a FreeRunDuration, then the EventDuration corresponds to the interval during which the capture was performed. The EventDuration is recorded in units of ns.

#### 7.3.2.4.3 *EventAveragePower*

The EventAveragePower is the average power of the event recorded in units of dBmV using 16-bit fixed point, fractional, two's complement notation encoded using the S6.9 format.

### 7.3.2.5 *RxMerData*<sup>180</sup>

This data type represents a sequence of received modulation error ratio (RxMER) values for an upstream OFDMA channel at the CM. The data is expressed as a series of RxMerDataValues - one RxMerDataValue for each subcarrier (active or excluded) from the lowest-frequency active subcarrier to the highest-frequency active subcarrier with no gaps.

#### 7.3.2.5.1 *RxMerDataValue*

This data type is used to express RxMER and is defined below:

- A single byte value with units of QuarterDb (e.g., a value of 23.75 dB = 0x5F)
- Range 0 to 63.5 dB in ¼ dB steps
- The value 0xFF is used to indicate no measurement is available for a given subcarrier

<sup>179</sup> Modified per CCAP-OSSiv3.1-N-16.1631-5 on 12/9/16 by KB.

<sup>180</sup> Modified per CCAP-OSSiv3.1-N-15.1307-3 on 6/1/15 by KB.

- Any value over 63.5 dB is reported as 63.5 dB
- Any value below 0 dB is reported as 0 dB

### 7.3.3 PNM Common Information Model<sup>181</sup>

This section defines the common Proactive Network Maintenance information model applicable to both the PNM Downstream Information Model described in Section 7.3.4 and the PNM Upstream Information Model described in Section 7.3.5.

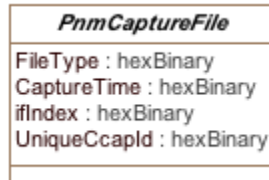

Figure 7-22 - PNM Common Information Model

#### 7.3.3.1 PnmCaptureFile Object

The DOCSIS 3.1 PHY specification [PHYv3.1] defines requirements for 17 Proactive Network Maintenance tests or features enabling the cable operator to measure and report conditions of the network to detect and measure undesired impacts to the network, such as cable faults and ingress noise. Some of these PNM tests generate files to report measurements or test results. The results file includes header information that is common to all types of PNM tests and fields, and data that are specific to the type of PNM test. The abstract PnmCaptureFile object defines the attributes and format of the header information common to all PNM test files. File header fields are right-justified within the field and left-padded with zero values if necessary.

Determination of maximum size of the PNM Capture File is left to vendor implementation.

Table 7-93 shows the format of the PNM capture file header, applied to any data file created by a PNM test.

Table 7-93 - PnmCaptureFile Object

Attribute Name	Type	Access	Type Constraints	Units	Default Value
FileType	HexBinary	R/O	SIZE (4) 504E4D65   504E4D66   504E4D67   504E4D68   504E4D69   504E4D6A	N/A	N/A
CaptureTime	HexBinary	R/O	SIZE (4)	N/A	N/A
ifIndex	HexBinary	R/O	SIZE (4)	N/A	N/A
UniqueCcapId	HexBinary	R/O	SIZE (256)	N/A	N/A

##### 7.3.3.1.1 FileType

A four-byte hexadecimal identifier specific to the type of PNM test that generated the data file.

Table 7-94 - PNM Downstream Test

PNM Test	File Type
CCAP Symbol Capture	504E4D65

<sup>181</sup> Added per CCAP-OSSv3.1-N-16.1536-6 on 11/15/16 by KB.



**Table 7-95 - PNM Upstream Tests**

<b>PNM Test</b>	<b>File Type</b>
Active and Quiet Probe	504E4D66
Impulse Noise	504E4D67
Histogram	504E4D68
RxMER	504E4D69
Triggered Spectrum Capture	504E4D6A

#### 7.3.3.1.2 *CaptureTime*

A four-byte hexadecimal field representing the epoch time (also known as 'unix time') which is the number of seconds that have elapsed since midnight Coordinated Universal Time (UTC), Thursday, 1 January 1970.

#### 7.3.3.1.3 *ifIndex*

A four-byte hexadecimal field representing the ifIndex of the upstream RF port sampled.

#### 7.3.3.1.4 *UniqueCcapId*

A 256-byte hexadecimal field representing a unique CCAP identifier (either a loopback address (IPv4 or IPv6) or FQDN). The value is a null-terminated string.

### 7.3.4 **PNM Downstream Object Model**<sup>182</sup>

There are two downstream Proactive Network Maintenance tests that are coordinated between the CCAP and CM. The related objects are defined in this section.

<sup>182</sup> This section and subsections modified by CCAP-OSSiv3.1-N-15.1250-2 on 3/3/15 by KB.

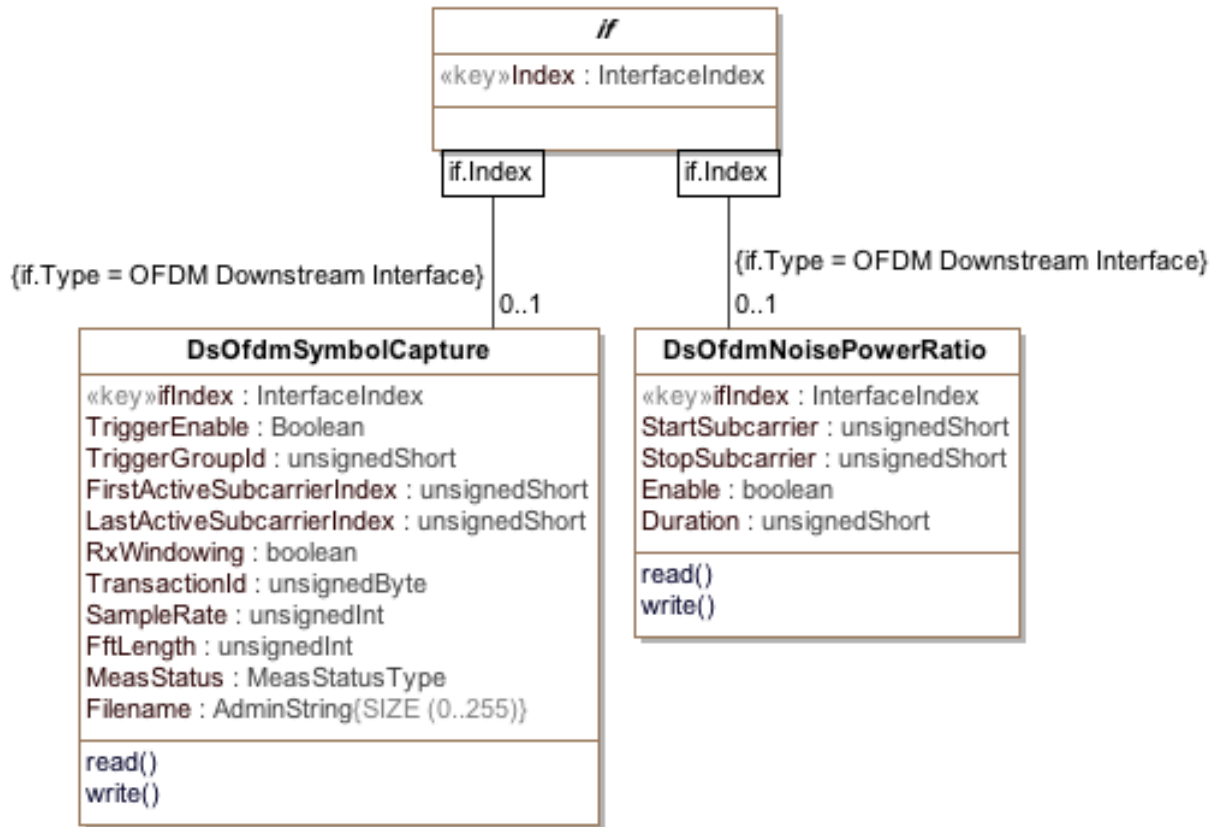

Figure 7-23 - Downstream PNM Object Model<sup>183</sup>

### 7.3.4.1 Object Definitions<sup>184</sup>

#### 7.3.4.1.1 Downstream OFDM Symbol Capture<sup>185</sup>

The DsOfdmSymbolCapture object provides partial functionality of a network analyzer to analyze the response of the cable plant.

At the CCAP, the transmitted frequency-domain modulation values of one full OFDM symbol before the IFFT are captured and made available for analysis. The frequency domain samples are expressed as 16-bit two's complement numbers using s3.12 format. This includes the I and Q modulation values of all subcarriers in the active bandwidth of the OFDM channel, including data subcarriers, pilots, PLC preamble symbols and excluded subcarriers. This capture will result in a number of samples that depends on the OFDM channel width, per [PHYv3.1] Downstream Transmitter Inverse Discrete Fourier Transform.

As examples, for 50 kHz subcarrier spacing in a 192 MHz channel with 204.8 MHz sampling rate, 3800 samples will be captured; for 25 kHz subcarrier spacing in a 192 MHz channel with 204.8 MHz sampling rate, 7600 samples will be captured; for 50 kHz subcarrier spacing in a 24 MHz channel with a reduced sampling rate of 25.6 MHz, 475 samples would be captured. Note: Excluded subcarriers in the 1 MHz guard band on either side of the encompassed spectrum are not captured.

<sup>183</sup> Modified per CCAP-OSSv3.1-N-15.1307-3 on 6/1/15 by KB; per CCAP-OSSv3.1-N-16.1496-2 on 5/16/16 by KB; per CCAP-OSSv3.1-N-16.1631-5 on 12/9/16 by KB.

<sup>184</sup> Subsections modified per CCAP-OSSv3.1-N-15.1307-3 on 6/1/15 by KB.

<sup>185</sup> Modified per CCAP-OSSv3.1-N-15.1343-2 on 8/13/15 by KB; per CCAP-OSSv3.1-N-16.1631-5 on 12/9/16 by KB.

Capturing the input and output of the cable plant is equivalent to a wideband sweep of the channel, which permits full characterization of the linear and nonlinear response of the downstream plant. The MAC provides signaling via the PLC Trigger Message to ensure that the same symbol is captured at the CCAP and CM.

The CCAP MUST create an instance of the DsOfdmSymbolCapture object for each IfIndex of a downstream channel.

**Table 7-96 - DsOfdmSymbolCapture Object Attributes<sup>186</sup>**

Attribute Name	Type	Access	Type Constraints	Units	Default Value
IfIndex	InterfaceIndex	Key	N/A	N/A	N/A
TriggerEnable	Boolean	R/W	Binary	Flag	False
TriggerGroupID	UnsignedShort	R/W	N/A	N/A	0
FirstActiveSubcarrierIndex	UnsignedShort	R/O	N/A	N/A	N/A
LastActiveSubcarrierIndex	UnsignedShort	R/O	N/A	N/A	N/A
RxWindowing	Boolean	R/O	N/A	N/A	N/A
TransactionId	UnsignedByte	R/O	N/A	N/A	N/A
SampleRate	UnsignedInt	R/O	N/A	Hz	N/A
FftLength	UnsignedInt	R/O	512   1024   2048   4096   8192	N/A	N/A
MeasStatus	MeasStatusType	R/O	N/A	N/A	N/A
Filename	AdminString	R/W	SIZE (0..255)	N/A	""

#### 7.3.4.1.1.1 IfIndex

This attribute is the ifIndex of an OFDM Downstream Channel and is a key to provide an index into the table.

#### 7.3.4.1.1.2 TriggerEnable

This attribute is used to instruct the CCAP to insert a Trigger Message Block in the PLC with a Group ID matching the CM's TriggerGroupID. The CCAP captures the Symbol that it designated in the Trigger Message Block. The TriggerEnable is a one-shot enable and the attribute is disabled when the CCAP has completed the acquisition of the designated Symbol.

Setting this attribute to a value of 'true' will change the value of the MeasStatus attribute to 'busy'.

#### 7.3.4.1.1.3 TriggerGroupID

This attribute is used by the CCAP to be inserted in the PLC Trigger MB to identify a CM or a group of CMs expected to perform Symbol Capture measurements for the designated symbol.

#### 7.3.4.1.1.4 FirstActiveSubcarrierIndex

This attribute is used to denote the subcarrier index of the lowest frequency of the Encompassed Spectrum for the OFDM channel.

#### 7.3.4.1.1.5 LastActiveSubcarrierIndex

This attribute is used to denote the subcarrier index of the highest frequency of the Encompassed Spectrum for the OFDM channel.

#### 7.3.4.1.1.6 RxWindowing

This attribute is a flag indicating if vendor proprietary Windowing was enabled during the capture.

<sup>186</sup> Modified per CCAP-OSSiv3.1-N-16.1496-2 on 5/16/16 by KB.

7.3.4.1.1.7 TransactionId

This attribute is the Transaction ID sent by the CCAP in the Trigger MB. Prior to completion of a measurement this attribute has no meaning.

7.3.4.1.1.8 SampleRate

This attribute is the FFT sample rate in use by the CM for the channel; typically the sample rate for the downstream channel will be 204.8 MHz.

7.3.4.1.1.9 FftLength

This attribute is the FFT length in use by the CM for the channel; typically this value is 4096 or 8192 for the Downstream Channel.

7.3.4.1.1.10 MeasStatus

This attribute is used to determine the status of the measurement. The PNM server will query the Status value to determine when the measurement is complete.

7.3.4.1.1.11 Filename<sup>187</sup>

This attribute contains the name of the file with the captured symbol data at the CCAP that is to be downloaded using TFTP to the PNM server.

This value can only be changed while a test is not in progress. An attempt to set this value while the value of MeasStatus is 'busy' will return 'inconsistentValue'.

If the value of this object is an empty string, then a default filename value will be used. Otherwise, the value set will be used as the filename. If a default filename is generated, then that value will be returned in this object and will represent the filename that was used for the test. All subsequent tests should set this object to a meaningful value or to an 'empty string' value (to generate a new default filename) before starting a new test.

If a default filename value is used, it is generated as the test name, plus a unique CCAP identifier (either a loopback address (IPv4 or IPv6) or FQDN), plus the 'epoch time'. The epoch time (also known as 'unix time') is defined as the number of seconds that have elapsed since midnight Coordinated Universal Time (UTC), Thursday, 1 January 1970.

Hence, the format would be:

PNMCcapSymCap\_<Unique CCAP Identifier>\_<epoch>

For example: PNMCcapSymCap\_ccap1.boulder.cablelabs.com\_1403405123

The data file is composed of a header plus the Symbol Capture Data. The header is composed of ordered fixed-length fields. Unless otherwise specified, the header fields contain hex values that are right-justified within the field. If necessary, the field is left-padded with zero values.

Syntax of the file is as follows:

**Table 7-97 - CCAP Symbol Capture File Format**

Element	Size
File type (value = 504E4D65)	4 bytes
Capture Time	4 bytes
IdxIndex	4 bytes
Unique CCAP ID	256 bytes
Subcarrier zero Frequency in Hz	4 bytes
Subcarrier Spacing in kHz	1 byte
FirstActiveSubcarrierIndex	2 bytes
LastActiveSubcarrierIndex	2 bytes

<sup>187</sup> Section, table, and subsections modified per CCAP-OSSv3.1-N-15.1343-2 on 8/13/15 by KB.

Element	Size
TriggerGroupId	2 bytes
Transaction ID	1 bytes
Length (in bytes) of Capture Data	4 bytes
Capture Data	ComplexData

### 7.3.4.1.1.11.1 File Header Element Definitions

#### 7.3.4.1.1.11.1.1 Capture Time

The epoch time (also known as 'unix time') is defined as the number of seconds that have elapsed since midnight Coordinated Universal Time (UTC), Thursday, 1 January 1970.

#### 7.3.4.1.1.11.1.2 IfIndex

The ifIndex of the OFDM Downstream Channel.

#### 7.3.4.1.1.11.1.3 Unique CCAP ID

A unique CCAP identifier (either a loopback address (IPv4 or IPv6) or FQDN). Value is a null terminated string.

#### 7.3.4.1.1.11.1.4 Subcarrier zero Frequency in Hz

The center frequency of subcarrier zero of the OFDM channel.

#### 7.3.4.1.1.11.1.5 Subcarrier Spacing in kHz

This element represents the subcarrier spacing in kHz.

#### 7.3.4.1.1.11.1.6 FirstActiveSubcarrierIndex

This element is a copy of the FirstActiveSubcarrier attribute.

#### 7.3.4.1.1.11.1.7 LastActiveSubcarrierIndex

This element is a copy of the LastActiveSubcarrier attribute.

#### 7.3.4.1.1.11.1.8 TriggerGroup ID

This element is a copy of the TriggerGroupId attribute.

#### 7.3.4.1.1.11.1.9 Transaction ID

This element is a copy of the TransactionId attribute.

#### 7.3.4.1.1.11.1.10 Length (in bytes) of Captured Data

This element indicates the size of the complexData which follows.

#### 7.3.4.1.1.11.1.11 Capture Data<sup>188</sup>

This element refers to the complexData values of the CMTS Symbol Capture. The data is expressed in s2.13 fixed point notation. Note: the average power of a given QAM constellation (not including pilots) = 1 [PHYv3.1].

<sup>188</sup> Added per CCAP-OSSiv3.1-N-15.1364-1 on 11/10/15 by KB.

### 7.3.4.1.2 Noise Power Ratio<sup>189</sup>

The purpose of downstream NPR measurement is to view the noise, interference and intermodulation products underlying a portion of the OFDM signal. As an out-of-service test, the CCAP can define an exclusion band of zero-valued subcarriers which forms a spectral notch in the downstream OFDM signal for all profiles of a given downstream channel. The CM provides its normal spectral capture measurements per [PHYv3.1], or symbol capture per [PHYv3.1], which permit analysis of the notch depth. A possible use case is to observe LTE interference occurring within an OFDM band; another is to observe intermodulation products resulting from signal-level alignment issues. Since the introduction and removal of a notch affects all profiles, causing possible link downtime, this feature is intended for infrequent maintenance.

The CCAP MUST create a row in the DsOfdmNoisePowerRatio table for each IfIndex of a downstream channel.

**Table 7-98 - DsOfdmNoisePowerRatio Object Attributes**

Attribute Name	Type	Access	Type Constraints	Units	Default Value
IfIndex	InterfaceType	Key	N/A	N/A	
StartSubcarrier	UnsignedShort	R/W	0..8191	N/A	
StopSubcarrier	UnsignedShort	R/W	0..8191	N/A	
Enable	Boolean	R/W	N/A	N/A	False
Duration	UnsignedShort	R/W	N/A	seconds	600

#### 7.3.4.1.2.1 IfIndex

This attribute is the ifIndex of an OFDM Downstream Channel and is a key to provide an index into the table.

#### 7.3.4.1.2.2 StartSubcarrier

This attribute is Subcarrier index corresponding to the frequency at the start of the spectral notch.

#### 7.3.4.1.2.3 StopSubcarrier

This attribute is Subcarrier index corresponding to the frequency at the upper end of the spectral notch.

#### 7.3.4.1.2.4 Enable

This attribute is used to enable the CCAP to create the spectral notch. The CCAP MAY require the interface to have an ifAdminStatus of 'down' before allowing the Enable value to be successfully set to 'true' for this test. If the CCAP is unable to create the spectral notch, the attempt to set Enable to True MUST be rejected by the CCAP. The Enable flag MUST be cleared internally by the CCAP when the operation is complete.

#### 7.3.4.1.2.5 Duration

This attribute indicates the length of time in seconds that the spectral notch is to be maintained. The CCAP MAY make the excluded subcarriers active after the expiration of the Duration attribute. There is no expectation that CCAP will re-activate the excluded subcarriers immediately after the expiration of the timer. It is recommended that the CCAP use the OCD message to create the spectral notch. The CCAP MUST only allow this value to be changed while the value of 'Enable' is 'false'.

## 7.3.5 PNM Upstream Object Models<sup>190</sup>

There are a number of upstream Proactive Network Maintenance tests that are conducted on the CCAP. The related objects are defined in this section.

<sup>189</sup> Modified per CCAP-OSSv3.1-N-15.1343-2 on 8/13/15 by KB.

<sup>190</sup> This section and subsections modified by CCAP-OSSv3.1-N-15.1250-2 on 3/3/15 by KB.

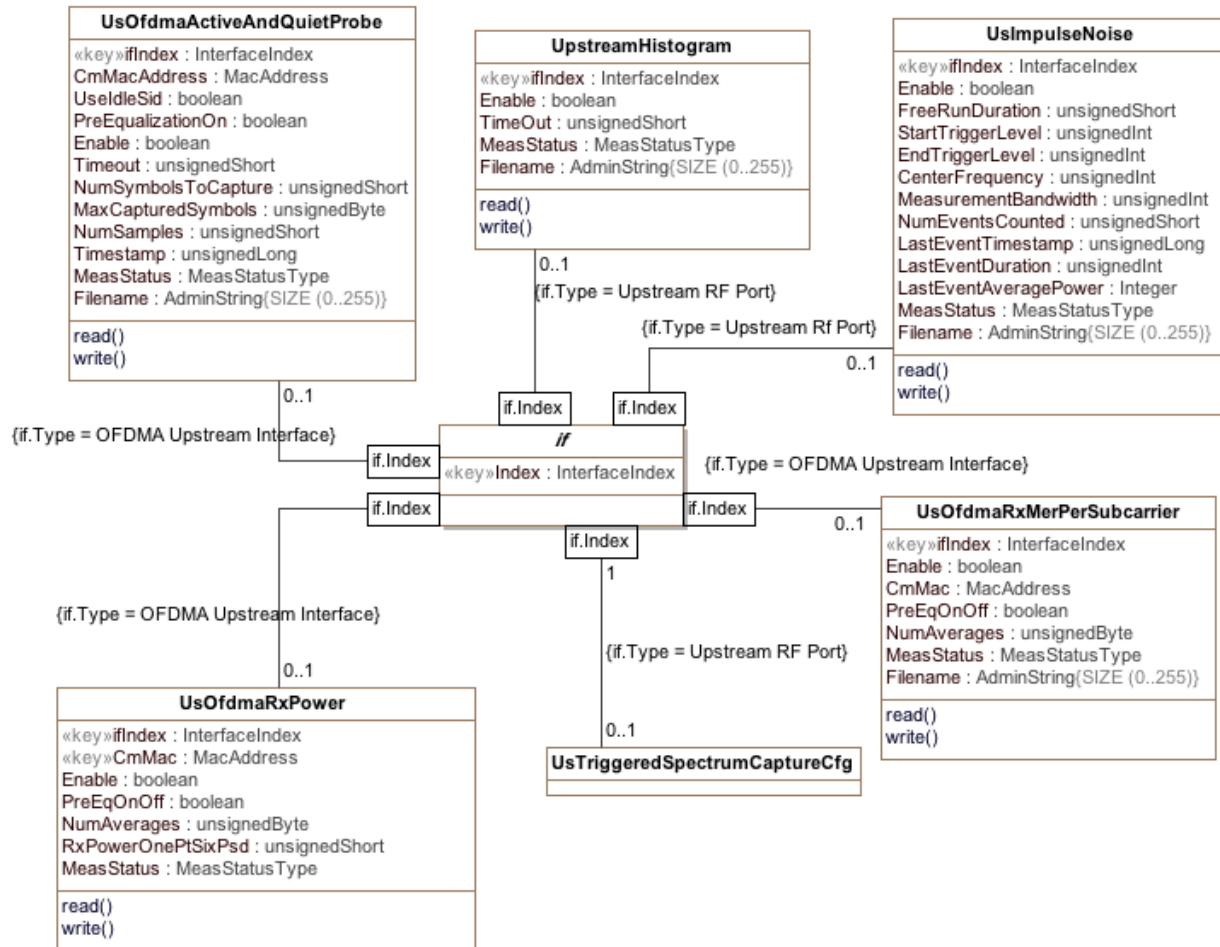

Figure 7-24 - Upstream PNM Information Model<sup>191</sup>

## 7.3.5.1 Object Definitions

### 7.3.5.1.1 Upstream Capture for Active and Quiet Probes<sup>192</sup>

The purpose of upstream capture is to measure plant response and view the underlying noise floor, by capturing at least one OFDMA symbol during a scheduled active or quiet probe. An active probe provides the partial functionality of a network analyzer, since the input is known and the output is captured. This permits full characterization of the linear and nonlinear response of the upstream cable plant. A quiet probe provides an opportunity to view the underlying noise and ingress while no traffic is being transmitted in the OFDMA band being measured.

The PNM server selects an active CM to analyze by specifying its MAC address, or requests a quiet probe measurement. When enabled to perform the capture, the CCAP selects a specified transmitting CM, or quiet period when no CMs are transmitting, for the capture. The CCAP sets up the capture as described in [MULPIV3.1], selecting either an active SID corresponding to the specified MAC address or the idle SID, and defining an active or quiet probe. The active probe symbol for this capture normally includes all non-excluded subcarriers across the

<sup>191</sup> Modified per CCAP-OSSIV3.1-N-15.1307-3 on 6/1/15 by KB; per CCAP-OSSIV3.1-N-16.1490-2 on 5/13/16 by KB; per CCAP-OSSIV3.1-N-16.1536-6 on 11/15/16 by KB; per CCAP-OSSIV3.1-N-16.1631-5 on 12/9/16 by KB.

<sup>192</sup> Subsections modified per CCAP-OSSIV3.1-N-15.1307-3 on 6/1/15 by KB; modified per CCAP-OSSIV3.1-N-15.1343-2 on 8/13/15 by KB..

upstream OFDMA channel, with pre-equalization on or off as specified in the MIB. The quiet probe symbol normally includes all subcarriers, that is, during the quiet probe time there are no transmissions in the given upstream OFDMA channel. For the quiet probe, the CCAP captures samples of at least one full OFDMA symbol including the guard interval. The CCAP begins the capture with the first symbol of the specified probe. The sample rate is the FFT sample rate (102.4 Msps).

The CCAP reports the list of excluded subcarriers, the cyclic prefix length, and the transmit window rolloff period in order to fully define the transmitted waveform. The CCAP also reports the index of the starting sample used by the receiver for its FFT. For possible comparison with other events, the CCAP reports the timestamp corresponding to the beginning of the probe. In the case where the P-MAPs for the OFDMA upstream being analyzed are being sent in an OFDM downstream, the timestamp reported is the extended timestamp, while in a case with OFDMA upstream channels but no OFDM downstream channels, the reported timestamp is the D3.0 timestamp. For an active probe, the CCAP reports the contents of the Probe Information Element (P-IE) message describing that probe.

The CCAP MUST create a row in the CmtsUsOfdmaActiveAndQuietProbe table for each IfIndex of an upstream channel.

**Table 7-99 - CmtsUsOfdmaActiveAndQuietProbe Object Attributes**

Attribute Name	Type	Access	Type Constraints	Units	Default Value
IfIndex	InterfaceIndex	Key	N/A	N/A	N/A
CmMacAddress	MacAddress	R/W	N/A	N/A	0x00000000 0000
UseIdleSid	Boolean	R/W	N/A	N/A	False
PreEqualizationOn	Boolean	R/W	N/A	N/A	False
Enable	Boolean	R/W	N/A	N/A	False
Timeout	UnsignedShort	R/W	N/A	Seconds	1800
NumSymbolsToCapture	UnsignedShort	R/W	N/A	Symbols	1
MaxCapturedSymbols	UnsignedByte	R/O	N/A	N/A	N/A
NumSamples	UnsignedShort	R/O	N/A	Samples	N/A
Timestamp	UnsignedLong	R/O	N/A	N/A	N/A
MeasStatus	MeasStatusType	R/O	N/A	N/A	N/A
Filename	String	R/W	N/A	N/A	""

#### 7.3.5.1.1.1 ifIndex

This attribute is the interface index of an OFDMA upstream channel and is a key to provide an index into the table.

#### 7.3.5.1.1.2 CmMacAddress

This attribute represents the MAC address of the CM transmitting the probe to be measured.

#### 7.3.5.1.1.3 UseIdleSid

This attribute when enabled causes the CCAP to measure the channel during a quiet period when no CM is transmitting.

#### 7.3.5.1.1.4 PreEqualizationOn

This attribute when enabled causes the CCAP to enable pre-equalization in the Probe Information Element for the CM transmitting the probe to be measured.

#### 7.3.5.1.1.5 Enable

This attribute causes the CCAP to begin the measurement of a probe for the selected CM or for a quiet period if the UseIdleSid attribute is enabled. The Enable attribute is cleared internally by the CCAP when the measurement has been completed.



#### 7.3.5.1.1.6 Timeout

This attribute provides a timeout for the measurement if the CCAP is unable to perform the measurement for some reason. A value of zero for the Timeout attribute means that the measurement continues to be active until the measurement is complete or until the Enable attribute is cleared.

#### 7.3.5.1.1.7 NumSymbolsToCapture

This attribute represents the number of symbols the CCAP is to capture for the modem whose probe is being measured or the number of symbol times to measure for the idle Sid.

#### 7.3.5.1.1.8 -MaxCapturedSymbols

This attribute represents the number of symbols the CCAP can capture for one measurement. Typically, for 50 kHz Subcarrier Spacing, the CCAP can capture two symbols, and for 25 kHz, the CCAP can capture one symbol. In order to capture more than one symbol, the CCAP would need to schedule multiple probe opportunities for the CM whose probe is being measured.

#### 7.3.5.1.1.9 NumSamples

This attribute represents the number of FFT samples used for the measurement.

#### 7.3.5.1.1.10 Timestamp

This attribute represents the timestamp corresponding to the time when measurement was performed. In the case in which the Primary Downstream is an OFDM channel this is the 64 bit timestamp. In the case in which the Primary Downstream is an SC-QAM channel this is the 32 bit timestamp. If the 32 bit timestamp is used, the 32 most significant bits of the timestamp are set to zero.

#### 7.3.5.1.1.11 MeasStatus

This attribute is used to determine the status of the command. When the Status = SampleReady, the CCAP has completed the measurement and the Enable attribute has been cleared.

#### 7.3.5.1.1.12 Filename<sup>193</sup>

This attribute is the name of the file with the captured probe data at the CCAP that is to be downloaded using TFTP to the PNM server.

This value can only be changed while a test is not in progress. An attempt to set this value while the value of 'MeasStatus' is 'busy' will return 'inconsistentValue'.

If the value of this object is the empty string, then a default filename value will be used. Otherwise, the value set will be used as the filename. If a default filename is generated, then that value will be returned in this object and will represent the filename that was used for the test. All subsequent tests should set this object to a meaningful value or to an 'empty string' value (to generate a new default filename) before starting a new test.

If a default filename value is used, it is generated as the test name, plus a unique CCAP identifier (either a loopback address (IPv4 or IPv6) or FQDN), plus the 'epoch time'. The epoch time (also known as 'unix time') is defined as the number of seconds that have elapsed since midnight Coordinated Universal Time (UTC), Thursday, 1 January 1970.

Hence, the format would be:

PNMCcapAQProbe\_<Unique CCAP Identifier>\_<epoch>

For example: PNMCCapAQProbe\_ccap1.boulder.cablelabs.com\_1403405123

The data file is composed of a header plus the Probe Capture Data. The header is composed of ordered fixed-length fields. Unless otherwise specified, the header fields contain hex values that are right-justified within the field. If necessary, the field is left-padded with zero values.

---

<sup>193</sup> Section, table, and subsections modified per CCAP-OSSiv3.1-N-15.1343-2 on 8/13/15 by KB.

Syntax of the file is as follows:

**Table 7-100 - Active and Quiet Probe File Format**

Element	Size
File type (value = 504E4D66)	4 bytes
Capture Time	4 bytes
IfIndex	4 bytes
Unique CCAP ID	256 bytes
Subcarrier zero frequency in Hz	4 bytes
Subcarrier Spacing in kHz	1 byte
Length in bytes of the Excluded Subcarrier Data	4 bytes
Excluded Subcarrier Data	ExclSubCarrierType
Length in bytes of the Probe Capture Data	4 bytes
Probe Capture Data	ComplexData

### 7.3.5.1.1.12.1 File Header Element Definitions

#### 7.3.5.1.1.12.1.1 Capture Time

The epoch time (also known as 'unix time') is defined as the number of seconds that have elapsed since midnight Coordinated Universal Time (UTC), Thursday, 1 January 1970.

#### 7.3.5.1.1.12.1.2 IfIndex

The ifIndex of the OFDMA Upstream Channel.

#### 7.3.5.1.1.12.1.3 Unique CCAP ID

A unique CCAP identifier (either a loopback address (IPv4 or IPv6) or FQDN). Value is a null terminated string.

#### 7.3.5.1.1.12.1.4 Subcarrier zero frequency in Hz

The center frequency of subcarrier zero of the OFDM channel.

#### 7.3.5.1.1.12.1.5 Subcarrier spacing in kHz

This element represents the subcarrier spacing for the OFDM channel.

#### 7.3.5.1.1.12.1.6 Length in bytes of the Excluded Subcarrier Data

This element represents the length of the excluded subcarrier data which follows.

#### 7.3.5.1.1.12.1.7 Excluded Subcarrier Data

This element contains the excluded subcarrier data as ExclSubCarType.

#### 7.3.5.1.1.12.1.8 Length in bytes of the Probe Capture Data

This element represents the length of the probe capture data which follows.

#### 7.3.5.1.1.12.1.9 Probe Capture Data<sup>194</sup>

This element refers to the complexData values of the Probe Capture Data. The data is expressed in s3.12 Fixed Point notation. The CMTS SHOULD adjust the scaling such that the average power of the samples is approximately 1, in order to avoid excessive clipping and quantization noise.

<sup>194</sup> Modified per CCAP-OSSv3.1-N-15.1364-1 on 11/10/15 by KB.

### 7.3.5.1.2 Upstream Impulse Noise Statistics<sup>195</sup>

The UsImpulseNoise object provides statistics of burst/impulse noise occurring in a selected narrow band. A bandpass filter is positioned in an unoccupied upstream band. A threshold is set, energy exceeding the threshold triggers the measurement of an event, and energy falling below the threshold ends the event. An optional feature allows the threshold to be set to zero, in which case the average power in the band will be measured. The measurement is time-stamped using the DOCSIS 3.0 field of the 64-bit extended timestamp (bits 9-40, where bit 0 is the LSB), which provides a resolution of 98 ns and a range of 7 minutes.

The CCAP provides the capability to capture the following statistics in a selected band up to 5.12 MHz wide:

- Timestamp of event

- Duration of event

- Average power of event

The CCAP provides a time history buffer of up to 1024 events. In steady state operation, a ring buffer provides the measurements of the last 1024 events that occurred while the measurement was enabled.

The CCAP MUST create an instance of the UsImpulseNoise object for each IfIndex of an upstream channel.

**Table 7-101 - UsImpulseNoise Object Attributes<sup>196</sup>**

Attribute Name	Type	Access	Type Constraints	Units	Default Value
IfIndex	InterfaceIndex	Key	N/A	N/A	N/A
Enable	Boolean	R/W	N/A	N/A	False
FreeRunDuration	UnsignedShort	R/W	N/A	seconds	60
StartTriggerLevel	UnsignedInt	R/W	N/A	microvolts	300uV
EndTriggerLevel	UnsignedInt	R/W	N/A	microvolts	150uV
CenterFrequency	UnsignedInt	R/W	N/A	Hz	7000000
MeasurementBandwidth	UnsignedInt	R/W	160   320   640   1280   2560   5120	kHz	2560
NumEventsCounted	UnsignedShort	R/O	N/A	N/A	N/A
LastEventTimestamp	UnsignedLong	R/O	N/A	N/A	N/A
LastEventDuration	UnsignedInt	R/O	N/A	nanoseconds	N/A
LastEventAveragePower	Short	R/O	N/A	dBmV	N/A
MeasStatus	MeasStatusType	R/O	N/A	N/A	N/A
Filename	String	R/W	N/A	N/A	""

#### 7.3.5.1.2.1 IfIndex

This attribute is the interface index of the upstream RF port and is a key to provide an index into the table.

#### 7.3.5.1.2.2 Enable

This attribute causes the CCAP to begin the collection of the configured Impulse Noise events. If the FreeRunDuration is set to a value greater than zero, the StartTriggerLevel is ignored and measurement of the signal power at the RF port begins when the Enable is set to true. The Enable attribute is cleared internally if FreeRunDuration has expired. If the FreeRunDuration is equal to zero and the Enable attribute is set to true, clearing the Enable causes the CCAP to stop the capture and generate the file of impulse noise data. If the NumEventsCounted is zero when the Enable is cleared, no file will be created.

#### 7.3.5.1.2.3 FreeRunDuration

This attribute provides length of time to perform the measurement when the Enable attribute is set to true.

<sup>195</sup> Subsections modified per CCAP-OSSiv3.1-N-15.1307-3 on 6/1/15 by KB; modified per CCAP-OSSiv3.1-N-15.1343-2 on 8/13/15 by KB; per CCAP-OSSiv3.1-N-16.1631-5 on 12/8/16 by KB.

<sup>196</sup> Modified per CCAP-OSSiv3.1-N-15.1307-3 on 6/1/15 by KB; per CCAP-OSSiv3.1-N-16.1631-5 on 12/8/16 by KB.

#### 7.3.5.1.2.4 StartTriggerLevel

If the FreeRunDuration is set to zero and the Enable attribute is set to true, an individual burst event starts when the burst noise exceeds the StartTriggerLevel.

#### 7.3.5.1.2.5 EndTriggerLevel

The measurement of an individual burst event ends when the burst noise falls below the EndTriggerLevel. It is worth noting that if the EndTriggerLevel is set to zero, the FreeRunDuration is set to zero and the Enable attribute is set to true, that at most a single Impulse Noise Event will be recorded when triggered by a burst event exceeding the StartTriggerLevel.

#### 7.3.5.1.2.6 CenterFrequency

This attribute defines the center frequency for the noise power measurement.

#### 7.3.5.1.2.7 MeasurementBandwidth

This attribute defines the bandwidth for the noise power measurement. The MeasurementBandwidth is the -3 dB bandwidth; the occupied bandwidth is typically 1.25 times the measurement bandwidth.

#### 7.3.5.1.2.8 NumEventsCounted

This attribute is used to indicate how many impulse noise events have been recorded since the Enable was set to true. This value will be 1024 in steady state, after the ring buffer has filled with measurements. If the StartTriggerLevel is set to zero, then the NumEventsCounted will be set to 1 when the FreeRunDuration has expired and the Enable has been internally cleared.

#### 7.3.5.1.2.9 LastEventTimestamp

This attribute provides represents the timestamp corresponding to the start of the last recorded event. The measurement is time-stamped using the 64-bit extended timestamp. If the CMTS is not using the 64-bit Extended Timestamp, then the 8 byte value is constructed from the 32-bit DOCSIS 3.0 Timestamp as follows:

Bits 63 through 41 = 0

Bits 40 through 9 = 32-bit DOCSIS 3.0 Timestamp

Bits 8 through 0 = 0

#### 7.3.5.1.2.10 LastEventDuration

This attribute provides represents the time corresponding to the duration of the last recorded event. The EventDuration is expressed in ns.

#### 7.3.5.1.2.11 LastEventAveragePower

This attribute represents the average power measured during the last recorded event. The LastEventAveragePower is expressed in units of dBmV with 16-bit fixed point, fractional, two's complement notation encoded using the S6.9 format.

#### 7.3.5.1.2.12 MeasStatus

This attribute is used to determine the status of the command. When the Status is sampleReady, the CCAP has completed the measurement and the Enable attribute has been cleared. If the StartTriggerLevel is set to a non zero value and the Enable attribute is set to true, then collection of Impulse Noise events is in progress and the MeasStatus attribute will return a value of 'busy'. If the Enable attribute is cleared while collection of Impulse Noise events is active, the MeasStatus attribute will be set to 'sampleReady'.

### 7.3.5.1.2.13 Filename<sup>197</sup>

This attribute is the name of the file with the captured impulse noise data at the CCAP that is to be downloaded using TFTP to the PNM server.

This value can only be changed while a test is not in progress. An attempt to set this value while the value of 'MeasStatus' is 'busy' will return 'inconsistentValue'.

If the value of this object is an empty string, then a default filename value will be used. Otherwise, the value set will be used as the filename. If a default filename is generated, then that value will be returned in this object and will represent the filename that was used for the test. All subsequent tests should set this object to a meaningful value or to an 'empty string' value (to generate a new default filename) before starting a new test.

If a default filename value is used, it is generated as the test name, plus a unique CCAP identifier (either a loopback address (IPv4 or IPv6) or FQDN), plus the 'epoch time'. The epoch time (also known as 'unix time') is defined as the number of seconds that have elapsed since midnight Coordinated Universal Time (UTC), Thursday, 1 January 1970.

Hence, the format would be:

PNMCcapImpNoise\_<Unique CCAP Identifier>\_<epoch>

For example: PNMCcapImpNoise\_ccap1.boulder.cablelabs.com\_1403405123

The data file is created when the Enable is cleared by the PNM server. If the NumEventsCounted attribute is zero when the Enable is cleared, then no file will be created by the CCAP. The data file is composed of a header plus the Probe Capture Data. The header is composed of ordered fixed-length fields. Unless otherwise specified, the header fields contain hex values that are right-justified within the field. If necessary, the field is left-padded with zero values.

Syntax of the file is as follows:

**Table 7-102 - Impulse Noise File Format**

Element	Size
File type (value = 504E4D67)	4 bytes
Capture Time	4 bytes
IfIndex	4 bytes
Unique CCAP ID	256 bytes
Start Trigger Level	4 bytes
End Trigger Level	4 bytes
Number of Events Being Reported	4 bytes
Length (in bytes) of Impulse Event Data	4 bytes
Impulse Noise Capture Data	ImpulseNoiseEventType

#### 7.3.5.1.2.13.1 File Header Element Definitions

##### 7.3.5.1.2.13.1.1 Capture Time

The epoch time (also known as 'unix time') is defined as the number of seconds that have elapsed since midnight Coordinated Universal Time (UTC), Thursday, 1 January 1970.

##### 7.3.5.1.2.13.1.2 IfIndex

The ifIndex of the OFDMA Upstream Channel.

##### 7.3.5.1.2.13.1.3 Unique CCAP ID

A unique CCAP identifier (either a loopback address (IPv4 or IPv6) or FQDN). Value is a null terminated string.

<sup>197</sup> Section, table, and subsections modified per CCAP-OSSiv3.1-N-15.1343-2 on 8/13/15 by KB.

7.3.5.1.2.13.1.4 Start Trigger Level

This element is a copy of the StartTriggerLevel attribute.

7.3.5.1.2.13.1.5 End Trigger Level

This element is a copy of the EndTriggerLevel attribute.

7.3.5.1.2.13.1.6 Number of Events Being Reported

This element is a copy of the NumEventsCounted attribute.

7.3.5.1.2.13.1.7 Length in bytes of the Impulse Event Data

This element represents the length of the impulse event data which follows.

7.3.5.1.3 Upstream Histogram<sup>198</sup>

The Upstream Histogram provides a measurement of nonlinear effects in the channel such as amplifier compression and laser clipping. For example, laser clipping causes one tail of the histogram to be truncated and replaced with a spike. When the UpstreamHistogram Enable attribute is set to 'true', the CCAP will begin capturing the histogram of time domain samples at the wideband front end of the receiver (full upstream band). The histogram is two-sided; that is, it encompasses values from far-negative to far-positive values of the samples. The histogram will have a minimum of 255 or 256 equally spaced bins. These bins typically correspond to the 8 MSBs of the wideband analog-to-digital converter (ADC) for the case of 255 or 256 bins. The histogram dwell count, a 32-bit unsigned integer, is the number of samples observed while counting hits for a given bin, and may have the same value for all bins. The histogram hit count, a 32-bit unsigned integer, is the number of samples falling in a given bin. The CCAP will report the dwell count per bin and the hit count per bin. When enabled, the CCAP will compute a histogram with a dwell of at least 10 million samples at each bin in 30 seconds or less. The CCAP will continue accumulating histogram samples until it is restarted, disabled or times out. If the highest dwell count approaches its 32-bit overflow value, the CCAP will save the current set of histogram values and reset the histogram, so that in a steady-state condition a complete measurement is always available.

The CCAP MUST create an instance of the UpstreamHistogram object for each IfIndex of an upstream RF port.

**Table 7-103 - UpstreamHistogram Object Attributes<sup>199</sup>**

Attribute Name	Type	Access	Type Constraints	Units	Default Value
IfIndex	ifIndex	Key	N/A	N/A	N/A
Enable	Boolean	R/W	N/A	N/A	False
TimeOut	UnsignedShort	R/W	N/A	Seconds	1800
MeasStatus	MeasStatusType	R/O	N/A	N/A	N/A
Filename	AdminString	R/W	SIZE (0..255)	N/A	""

7.3.5.1.3.1 IfIndex

This attribute is the interface index of an upstream RF Port and is a key to provide an index into the table.

7.3.5.1.3.2 Enable

Setting this attribute to a value of 'true' instructs the CCAP to begin collection of histogram data and when enabled, the CCAP continues producing new data at its own rate.

This value is only allowed to be set to 'true' if the value of 'MeasStatus' is a value other than 'busy'. Setting this value to 'true' will change the value of the 'MeasStatus' attribute to 'busy'.

<sup>198</sup> Subsections modified per CCAP-OSSv3.1-N-15.1307-3 on 6/1/15 by KB; modified per CCAP-OSSv3.1-N-15.1343-2 on 8/13/15 by KB; per CCAP-OSSv3.1-N-16.1496-2 on 5/16/16 by KB; per CCAP-OSSv3.1-N-16.1631-5 on 12/9/16 by KB.

<sup>199</sup> Modified per CCAP-OSSv3.1-N-15.1307-3 on 6/1/15 by KB.

Setting this attribute to a value of 'false' instructs the CCAP to stop the collection of histogram data and to generate the file.

This attribute returns 'true' if the CCAP is actively collecting histogram data. Otherwise it returns 'false'.

A restart may be accomplished by setting this attribute to 'false' and then back to 'true'.

#### 7.3.5.1.3.3 Timeout

This attribute sets a seconds time-out timer for capturing histogram data. This attribute is used to automatically clear the Enable attribute when the timeout expires. If the value of Timeout is zero, the CCAP MUST collect data until the value is changed, stopped, or until any dwell counter approaches its 32-bit rollover value. If the Timeout attribute is re-written while Enable is 'true', the CCAP MUST restart the timeout timer with the new Timeout value and continue collecting data.

When the timeout expires, the 'Enable' object will be set to 'false' and the capture will stop. When this happens, the data collected up to this point will be saved in the file defined by the 'FileName', and the value of 'MeasStatus' will be set to 'sampleReady'.

Setting this value does not start a capture. Captures can only be started by setting the 'Enable' attribute.

If this attribute is written while the 'Enable' attribute is 'true', the timer is restarted.

This object returns the value with which it was last set.

#### 7.3.5.1.3.4 MeasStatus

This attribute is used to determine the status of the command. When the Status is 'sampleReady', the CCAP is ready for the Histogram data to be read.

#### 7.3.5.1.3.5 Filename<sup>200</sup>

This attribute is the name of the file at the CCAP which is to be transferred to the PNM server. The data is stored as 32-bit integers for the hit and dwell count values.

This value can only be changed while a test is not in progress. An attempt to set this value while the value of MeasStatus is 'busy' will return 'inconsistentValue'.

If the value of this object is an empty string, then a default filename value will be used. Otherwise, the value set will be used as the filename. If a default filename is generated, then that value will be returned in this object and will represent the filename that was used for the test. All subsequent tests should set this object to a meaningful value or to an 'empty string' value (to generate a new default filename) before starting a new test.

If a default filename value is used, it is generated as the test name, plus a unique CCAP identifier (either a loopback address (IPv4 or IPv6) or FQDN), plus the 'epoch time'. The epoch time (also known as 'unix time') is defined as the number of seconds that have elapsed since midnight Coordinated Universal Time (UTC), Thursday, 1 January 1970.

Hence, the format would be:

PNMCcapHist\_<Unique CCAP Identifier>\_<epoch>

For example: PNMCcapHist\_ccap1.boulder.cablelabs.com\_1403405123

The data file is composed of a header plus the Histogram Data. The header is composed of ordered fixed-length fields. Unless otherwise specified, the header fields contain hex values that are right-justified within the field. If necessary, the field is left-padded with zero values.

---

<sup>200</sup> Section, table, and subsections modified per CCAP-OSSiv3.1-N-15.1343-2 on 8/13/15 by KB.

Syntax of the file is as follows:

**Table 7-104 - Upstream Histogram File Format**

Element	Size
File type (value = 504E4D68)	4 bytes
Capture Time	4 bytes
IfIndex	4 bytes
Unique CCAP ID	256 bytes
Symmetry	4 bytes
Length (in bytes) of Dwell Count Values	4 bytes
DwellCount values	(1-4096) * 4 bytes
Length (in bytes) of Hit Count Values	4 bytes
HitCount values	(1-4096) * 4 bytes

**7.3.5.1.3.5.1 File Header Element Definitions**

*7.3.5.1.3.5.1.1 Capture Time*

The time (epoch time) that the file was written. The epoch time (also known as 'unix time') is defined as the number of seconds that have elapsed since midnight Coordinated Universal Time (UTC), Thursday, 1 January 1970.

*7.3.5.1.3.5.1.2 IfIndex*

The ifIndex of the OFDMA Upstream RF Port.

*7.3.5.1.3.5.1.3 Unique CCAP ID*

A unique CCAP identifier (either a loopback address (IPv4 or IPv6) or FQDN). The value is a null terminated string.

*7.3.5.1.3.5.1.4 Symmetry*

This attribute is used to indicate whether 256 or 255 bins were used for the measurement.

Even Symmetry = 'false' (default):

The histogram has even symmetry about the origin. There is no bin center lying directly at the origin; rather, two bin centers straddle the origin at 0.5. All bins with indices 0-255 contain valid hit-count data. The histogram bin centers are offset from the corresponding 8-bit twos-complement integer values by 1/2, that is, bin center = twos complement value + 0.5.

Odd Symmetry = 'true':

The histogram has odd symmetry about the origin. There is a bin center lying at the origin. The bin with index 0 is not used and returns the value 0. The bins with indices 1 to 255 contain valid hit-count data. The histogram bin centers are located on the corresponding 8-bit twos-complement integer values.

The following table shows the defined histogram bin centers for the cases of even and odd symmetry.

**Table 7-105 - Histogram Bin Centers**

Bin Index	Bin Center Even Symmetry	Bin Center Odd Symmetry
0	-127.5	not used
1	-126.5	-127
2	-125.5	-126
...	...	...
127	-0.5	-1
128	0.5	0



Bin Index	Bin Center Even Symmetry	Bin Center Odd Symmetry
129	1.5	1
...	...	...
253	125.5	125
254	126.5	126
255	127.5	127

#### 7.3.5.1.3.5.1.5 Length in bytes of Dwell Count Values

This element represents the number of Dwell Count Values which follow in the file.

#### 7.3.5.1.3.5.1.6 Dwell Count Values

This element represents the Dwell Counts for each bin for the "Current" capture. The value is a sequence of 4-byte values. If the dwell count for all bins is the same, then only a single value is reported. The value for each bin is reported as a 32-bit value.

#### 7.3.5.1.3.5.1.7 Length in bytes of Hit Count Values

This element represents the number of Hit Count Values which follow in the file.

#### 7.3.5.1.3.5.1.8 Hit Count Values

This element represents the Hit Counts for each bin for the "Current" capture. The value represents a sequence of 4-byte values. If odd symmetry is used, then there will be 255 bins. The value for each bin is reported as a 32-bit value.

### 7.3.5.1.4 Upstream OFDMA Channel Receive Power<sup>201</sup>

The purpose of the upstream channel power metric is to provide an estimate of the received power in a specified OFDMA channel at the F connector input of the CCAP line card for a given user. The measurement is based on upstream probes, which are typically the same probes used for pre-equalization adjustment.

The CCAP measures the total power of the probe subcarriers received from the CM.

For channels without boosted pilots, the CCAP calculates the average power per subcarrier ( $P_{\text{average}}$ ) and then calculates the power normalized to 1.6 MHz as a)  $P_{\text{average}} + 10 * \log_{10}(32)$  for 50 kHz subcarrier spacing, or as b)  $P_{\text{average}} + 10 * \log_{10}(64)$  for 25 kHz subcarrier spacing.

For channels with boosted pilots, the CCAP calculates the average power per subcarrier ( $P_{\text{average}}$ ) and then calculates the power normalized to 1.6 MHz as a)  $P_{\text{average}} + 10 * \log_{10}(32) + 1$  dB for 50 kHz subcarrier spacing, or as b)  $P_{\text{average}} + 10 * \log_{10}(64) + 0.5$  dB for 25 kHz subcarrier spacing.

The CCAP MUST create a row in the UsOfdmaRxPower table for each IfIndex of an upstream channel.

**NOTE:** The CCAP would also use that adjusted value for comparison with the Target Receive Power for the purposes of transmit power adjustments in the RNG-RSP.

**Table 7-106 - UsOfdmaRxPower Object Attributes<sup>202</sup>**

Attribute Name	Type	Access	Type Constraints	Units	Default Value
IfIndex	InterfaceIndex	Key	N/A	N/A	N/A
CmMac	MacAddress	Key	N/A	N/A	N/A

<sup>201</sup> Section and subsections modified per CCAP-OSSiv3.1-N-15.1307-3 on 6/1/15 by KB; modified per CCAP-OSSiv3.1-N-15.1343-2 on 8/13/15 by KB..

<sup>202</sup> Modified per CCAP-OSSiv3.1-N-16.1464-3 on 5/13/16 by KB.

Attribute Name	Type	Access	Type Constraints	Units	Default Value
Enable	Boolean	R/W	N/A	N/A	False
PreEqOnOff	Boolean	R/W	N/A	N/A	False
NumAverages	UnsignedByte	R/W	N/A	N/A	1
RxPowerOnePtSixPsd	unsignedShort	R/O	N/A	tenthDb	N/A
MeasStatus	MeasStatusType	R/O	N/A	N/A	N/A

7.3.5.1.4.1 IfIndex

This attribute is the interface index of an OFDMA upstream channel and is a key to provide an index into the table.

7.3.5.1.4.2 CmMac

This attribute represents the MAC address of the CM whose Received upstream channel power is being measured.

7.3.5.1.4.3 Enable

This attribute causes the CCAP to begin a measurement of the received upstream channel power for the CM whose MAC address was specified in the CmMac attribute.

7.3.5.1.4.4 PreEqOnOff

This attribute is used by the CCAP to enable or disable pre-equalization of the probe. The pre-equalization is controlled by a bit in the Probe Information Element sent in a MAP to the CM.

7.3.5.1.4.5 NumAverages

This attribute controls the time average over the number of probes the CCAP will use to calculate the RxUsRxOfdmaPowerOnePtSix. The average is simply the sum of the RxUsRxOfdmaPowerOnePtSix values divided by the NumAverages.

7.3.5.1.4.6 RxPowerOnePtSixPsd

This attribute represents the average power of the probe measured by the CCAP, reported as the Power Spectral Density in an equivalent 1.6 MHz spectrum, for the CM whose MAC address was specified in the CmMac attribute. If the NumberOfAverages attribute was greater than one, then this attribute represents the accumulated average 1.6 MHz PSD.

7.3.5.1.4.7 MeasStatus

This attribute is used to determine the status of the command. When the Status = SampleReady, the CCAP is ready for the Upstream Power data to be read.

7.3.5.1.5 Upstream Receive Modulation Error Ratio (RxMER) Per Subcarrier<sup>203</sup>

This item provides measurements of the upstream receive modulation error ratio (RxMER) for each subcarrier. The CCAP measures the RxMER using an upstream probe, which is not subject to symbol errors as data subcarriers would be. The probes used for RxMER measurement are typically distinct from the probes used for pre-equalization adjustment. For the purposes of this measurement, RxMER is defined as the ratio of the average power of the ideal QAM constellation to the average error-vector power. The error vector is the difference between the equalized received probe value and the known correct probe value. If some subcarriers (such as exclusion bands) cannot be measured by the CCAP, the CCAP indicates that condition in the measurement data for those subcarriers.

The CCAP MUST create a row in the UsOfdmaRxMerPerSubcarrier table for each IfIndex of an upstream channel.

<sup>203</sup> Subsections modified per CCAP-OSSiv3.1-N-15.1307-3 on 6/1/15 by KB; modified per CCAP-OSSiv3.1-N-15.1343-2 on 8/13/15 by KB..

**Table 7-107 - UsOfdmaRxMerPerSubcarrier Object Attributes<sup>204</sup>**

Attribute Name	Type	Access	Type Constraints	Units	Default Value
IfIndex	InterfaceIndex	Key	N/A	N/A	N/A
Enable	Boolean	R/W	N/A	N/A	False
CmMac	MacAddress	R/W	N/A	N/A	0x000000000000
PreEqOnOff	Boolean	R/W	N/A	N/A	False
NumAverages	UnsignedByte	R/W	N/A	N/A	N/A
MeasStatus	MeasStatusType	R/O	N/A	N/A	N/A
Filename	String	R/W	N/A	N/A	""

#### 7.3.5.1.5.1 IfIndex

This attribute is the interface index of an OFDMA upstream channel and is a key to provide an index into the table.

#### 7.3.5.1.5.2 Enable

This attribute causes the CCAP to begin a measurement of the received MER per subcarrier for the CM whose MAC address was specified in the CmMac attribute.

#### 7.3.5.1.5.3 CmMac

This attribute represents the MAC address of the CM whose Rx MER is being measured.

#### 7.3.5.1.5.4 PreEqOnOff

This attribute is used by the CCAP to enable or disable Pre Equalization of the probe. The Pre Equalization is controlled by a bit in the Probe Information Element sent in a MAP to the CM.

#### 7.3.5.1.5.5 NumAverages

This attribute controls the number of probes the CCAP will use to calculate the Rx MER per subcarrier. The average will be computed using the "leaky integrator" method, where reported Rx MER per subcarrier value =  $\alpha * \text{accumulated values} + (1 - \alpha) * \text{current value}$ . Alpha is one minus the reciprocal of the number of averages. For example, if  $N=25$ , then  $\alpha = 0.96$ . A value of 1 indicates no averaging. Re-writing the number of averages will restart the averaging process. If there are no accumulated values, the accumulators are made equal to the first measured bin amplitudes.

#### 7.3.5.1.5.6 MeasStatus

This attribute is used to determine the status of the command. When the MeasStatus = SampleReady, the CMTS is ready for the RxMER data to be read.

#### 7.3.5.1.5.7 Filename<sup>205</sup>

This attribute is the name of the file with the RxMER data for a specified CM at the CCAP that is to be downloaded using TFTP to the PNM server.

This value can only be changed while a test is not in progress. An attempt to set this value while the value of 'MeasStatus' is 'busy' will return 'inconsistentValue'.

If the value of this object is the empty string, then a default filename value will be used. Otherwise, the value set will be used as the filename. If a default filename is generated, then that value will be returned in this object and will

<sup>204</sup> Modified per CCAP-OSSiv3.1-N-15.1307-3 on 6/1/15 by KB.

<sup>205</sup> Section, table, and subsections modified per CCAP-OSSiv3.1-N-15.1343-2 on 8/13/15 by KB; per CCAP-OSSiv3.1-N-16.1496-2 on 5/16/16 by KB.

represent the filename that was used for the test. All subsequent tests should set this object to a meaningful value or to an 'empty string' value (to generate a new default filename) before starting a new test.

If a default filename value is used, it is generated as the test name, plus a unique CCAP identifier (either a loopback address (IPv4 or IPv6) or FQDN), plus the 'epoch time'. The epoch time (also known as 'unix time') is defined as the number of seconds that have elapsed since midnight Coordinated Universal Time (UTC), Thursday, 1 January 1970.

Hence, the format would be:

PNMCcapRxMER\_<Unique CCAP Identifier>\_<epoch>

For example: PNMCcapRxMER\_ccap1.boulder.cablelabs.com\_1403405123

The data file is composed of a header plus the RxMER Data. The header is composed of ordered fixed-length fields. Unless otherwise specified, the header fields contain hex values that are right-justified within the field. If necessary, the field is left-padded with zero values.

Syntax of the file is as follows:

**Table 7-108 - RxMER File Format**

Element	Size
File type (value = 504E4D69)	4 bytes
Capture Time	4 bytes
IfIndex	4 bytes
Unique CCAP ID	256 bytes
CM MAC Address	6 bytes
Number of averages	2 bytes
PreEq On or Off	1 byte
Subcarrier zero center frequency	4 bytes
FirstActiveSubcarrierIndex	2 bytes
Subcarrier Spacing in kHz	1 byte
Length in bytes of RxMER data	4 bytes
Subcarrier RxMER data	RxMerData

**7.3.5.1.5.7.1 File Header Element Definitions**

*7.3.5.1.5.7.1.1 Capture Time*

The epoch time (also known as 'unix time') is defined as the number of seconds that have elapsed since midnight Coordinated Universal Time (UTC), Thursday, 1 January 1970.

*7.3.5.1.5.7.1.2 IfIndex*

The ifIndex of the OFDMA Upstream Channel.

*7.3.5.1.5.7.1.3 Unique CCAP ID*

A unique CCAP identifier (either a loopback address (IPv4 or IPv6) or FQDN). Value is a null terminated string.

*7.3.5.1.5.7.1.4 CM MAC Address*

This element is a copy of the CmMac attribute.

*7.3.5.1.5.7.1.5 Number of averages*

This element is a copy of the NumAverages attribute.

*7.3.5.1.5.7.1.6 PreEq On or Off*

This element is a copy of the PreEqOnOff attribute.

7.3.5.1.5.7.1.7 Subcarrier Zero Center Frequency

This element represents the center frequency of the subcarrier zero of the OFDMA channel.

7.3.5.1.5.7.1.8 FirstActiveSubcarrierIndex

This element is the subcarrier index of the lowest subcarrier in the Encompassed Spectrum of the channel.

7.3.5.1.5.7.1.9 Subcarrier Spacing in kHz

This element is the OFDMA subcarrier spacing.

7.3.5.1.5.7.1.10 Length in bytes of the RxMer data

This element represents the number of the RxMerData which follow in the file.

7.3.5.1.6 Upstream Triggered Spectrum Capture<sup>206</sup>

The upstream triggered spectrum analysis measurement provides a wideband spectrum analyzer function in the CCAP which can be triggered to examine desired upstream transmissions as well as underlying noise/interference during a quiet period. Figure 7-25 illustrates the information model for the CCAP Upstream Triggered Spectrum Capture function. The classes and attributes shown in the model are described below.

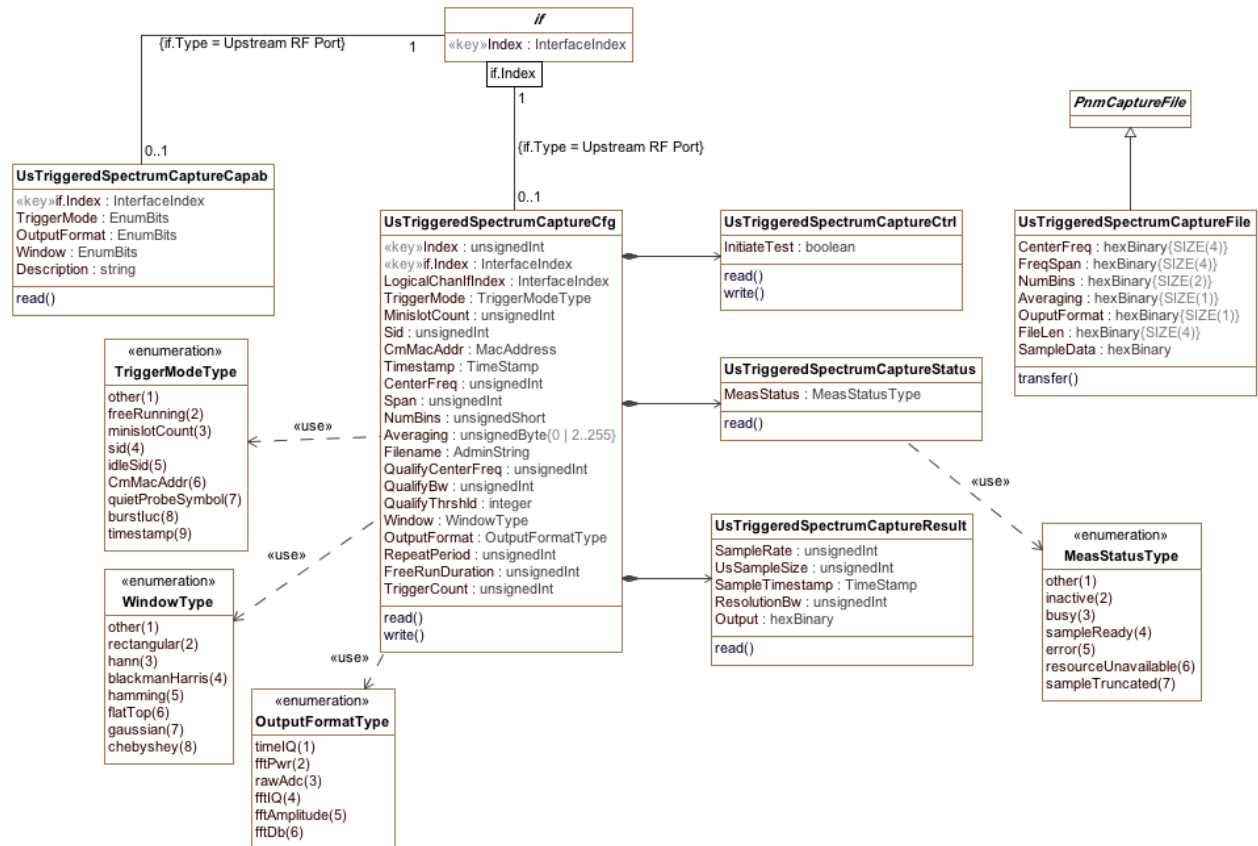

Figure 7-25 - Upstream Triggered Spectrum Capture Information Model

<sup>206</sup> Subsections modified per CCAP-OSSiv3.1-N-15.1307-3 on 6/1/15 by KB; modified per CCAP-OSSiv3.1-N-15.1343-2 on 8/13/15 by KB; per CCAP-OSSiv3.1-N-16.1496-2 on 5/16/16 by KB; section replaced per CCAP-OSSiv3.1-N-16.1536-6 on 11/15/16 by KB.

The CCAP provides wideband upstream spectrum analysis capability covering the full upstream spectrum of the cable plant. The CCAP can be made to use 100 kHz or better resolution (bin spacing) in the wideband upstream spectrum measurement.

Depending on the particular CCAP implementation, variable upstream spectrum analysis span is possible.

The CCAP is also able to provide the time-domain input samples as an alternative to the frequency-domain upstream spectrum results.

The CCAP provides the ability to trigger spectrum sample capture and perform spectrum analysis using the following modes:

- Free running
- A specified timestamp value
- Minislot Number
- A specified MAC address defining a SID, triggering at the beginning of the first minislot granted to that SID
- The idle SID, triggering at the beginning of the first minislot granted to that SID
- A specified active or quiet probe symbol, triggering at the beginning of the probe symbol

The CCAP SHOULD support creating and deleting instances of `UsTriggeredSpectrumCapture`. It is not required for a CCAP to support multiple simultaneous requests.

Note that upstream triggered spectrum analysis measures the power vs frequency of any input signal, including TDMA/A-TDMA, OFDMA, OOB upstream, ingress, and noise.

The Upstream Triggered Spectrum Capture function is described in four objects associated with the four fundamental functions listed below:

- Test configuration (Cfg)
- Test control (Ctrl)
- Test monitoring (Status)
- Test result reporting (Result)

The same pair of indexes are defined for the four (Cfg, Ctrl, Status and Result) Upstream Triggered Spectrum Capture objects. This links the four objects such that the same values for the pair of indexes accesses the same instance of each of the objects. Therefore, the attributes in one object indexed with `Index = x` and `ifIndex = y` correspond to the attributes in each of the other three objects indexed with `Index = x` and `ifIndex = y`. An entry created in one object with `Index = x` and `ifIndex = y` also automatically creates an entry in the other three objects with `Index = x` and `ifIndex = y`.

The CCAP is not required to retain the RF port capture configuration when the CCAP is reset.

If the CCAP supports line card failover protections, the CCAP is not required to retain the RF port capture configuration when a failover occurs.

A CCAP PNM Upstream Triggered Spectrum Capture Capabilities object is provided to allow a CCAP to advertise its US Spectrum Capture capabilities.

The Upstream Triggered Spectrum Capture feature supports eight trigger modes, and for each mode a set of attributes need to be configured to provide the CCAP with the information it needs to perform the capture. Table 7-109 identifies the attributes that are required to be configured for each trigger mode.

The CCAP MUST NOT initiate an Upstream Triggered Spectrum Capture test if required attributes listed in Table 7-109 for the configured trigger mode are not configured with a value. It is not required to configure Filename each time Upstream Triggered Spectrum Capture test is initiated, but this is recommended.

For each trigger mode, the operator can optionally configure Averaging, Filename, QualifyCenterFreq, QualifyBw, QualifyThreshld, Window, OutputFormat, RepeatPeriod, or TriggerCount. Default values are used for these attributes if they are not configured.

**Table 7-109 - Attributes Required to be Configured for Each Trigger Mode**

Trigger Mode	Attributes Required to be Configured
Free Running	CenterFreq, Span, NumBins
Minislot Count	MinislotCount, CenterFreq, Span
SID	Sid, CenterFreq, Span
Idle SID	CenterFreq, Span
CM MAC Address	CmMacAddr, CenterFreq, Span
Quiet Probe Symbol	CenterFreq, Span
Burst IUC	CenterFreq, Span
Timestamp	Timestamp, CenterFreq, Span

### 7.3.5.1.6.1 UsTriggeredSpectrumCaptureCapab Object

The Upstream Triggered Spectrum Capture Capabilities object exposes capabilities supported by the CCAP for Upstream Triggered Spectrum Capture trigger modes, data output formats, and windowing function used when performing the discrete Fourier transform.

**Table 7-110 - UsTriggeredSpectrumCaptureCapab Object**

Attribute Name	Type	Access	Type Constraints	Units	Default Value
TriggerMode	EnumBits	R/O	other(0), freeRunning(1), miniSlotCount(2), sid(3), idleSid(4), cmMac(5), quietProbeSymbol(6), burstIuc(7), timestamp(8)	N/A	
OutputFormat	EnumBits	R/O	other(0) timeIQ(1), fftPower(2), rawAdc(3), fftIQ(4), fftAmplitude(5), fftDb(6)	N/A	
Window	EnumBits	R/O	other(0), rectangular(1), hann(2), blackmanHarris(3), hamming(4), flatTop(5), gaussian(6), chebyshev(7)	N/A	
Description	string	R/O		N/A	

#### 7.3.5.1.6.1.1 TriggerMode

This attribute indicates which of the upstream triggered spectrum capture function trigger modes is supported by the CCAP. TriggerMode attribute is reported in BITS format, with value 0 for each bit definition indicating the CCAP does not support the corresponding TriggerMode, and value 1 for each bit definition indicating the CCAP supports the corresponding trigger mode. See the description of the UsTriggeredSpectrumCaptureCfg object TriggerMode

attribute for more information about CCAP upstream triggered spectrum capture trigger modes. The value other(0) is provided for vendor-proprietary and future extensions.

#### 7.3.5.1.6.1.2 OutputFormat

This attribute indicates which of the upstream triggered spectrum capture function data output formats are supported by the CCAP. OutputFormat attribute is reported in BITS format, with value 0 for each bit definition indicating the CCAP does not support the corresponding OutputFormat, and value 1 for each bit definition indicating the CCAP supports the corresponding output data format. See the description of the UsTriggeredSpectrumCaptureCfg object OutputFormat attribute for more information about CCAP upstream triggered spectrum capture output formats. The value other(0) is provided for vendor-proprietary and future extensions.

#### 7.3.5.1.6.1.3 Window

This attribute indicates which of the upstream triggered spectrum capture function window formats are supported by the CCAP. The Window attribute is reported in BITS format, with value for each bit definition 0 indicating the CCAP does not support the corresponding Window option and value 1 for each bit definition indicating the CCAP supports the corresponding Window option. See the description of the UsTriggeredSpectrumCaptureCfg object Window attribute for more information about CCAP upstream triggered spectrum capture window options. The value other(0) is provided for vendor-proprietary and future extensions.

#### 7.3.5.1.6.1.4 Description

This attribute reports a textual description of a CCAP's upstream triggered spectrum capture capabilities. The format is vendor-specific. Example content can include, but is not limited to:

- Center Frequency range and resolution
- Frequency Span range and resolution
- Sampling rate each frequency span
- Averaging range and resolution
- Averaging method
- Number of time domain IQ samples
- Number of FFT bins

#### 7.3.5.1.6.2 UsTriggeredSpectrumCaptureFile Object

The Upstream Triggered Spectrum Capture File object defines the format for the Upstream Triggered Spectrum Capture test-specific information in the data capture file created by the CCAP when an Upstream Triggered Spectrum Capture test is executed.

When the CCAP runs an Upstream Triggered Spectrum Capture test, it MUST create a results file composed of the PnmCaptureFile header fields as defined in Section 7.3.3.1 followed by the UsTriggeredSpectrumCaptureFile fields described in this section. Capture file fields are right-justified within the field and left-padded with zero values if necessary. The implemented values of various parameters may be different from the requested values, as the spectrum analysis function will provide the implementation value closest to the requested value.

The content of the Upstream Triggered Spectrum Capture file can be retrieved via SNMP or bulk file transfer. Refer to the UsTriggeredSpectrumCaptureResult object and the CCAP Bulk Data Transfer section, respectively.

In the event of insufficient memory resources to create a new capture file, the CCAP MUST overwrite the oldest stored capture file with the new capture file being created.

**Table 7-111 - UsTriggeredSpectrumCaptureFile Object**

Attribute Name	Type	Access	Type Constraints	Units	Default Value
CenterFreq	HexBinary	R/O	SIZE (4)	Hz	



Attribute Name	Type	Access	Type Constraints	Units	Default Value
FreqSpan	HexBinary	R/O	SIZE (4)	Hz	
NumBins	HexBinary	R/O	SIZE (2)	N/A	
Averaging	HexBinary	R/O	SIZE (1)	N/A	
SamplingRate	HexBinary	R/O	SIZE(2)	Hz	
OutputFormat	HexBinary	R/O	SIZE (1)	N/A	
FileLen	HexBinary	R/O	SIZE (4)	Bytes	
SampleData	HexBinary	R/O		N/A	

#### 7.3.5.1.6.2.1 CenterFreq

A four-byte hexadecimal field containing the implemented value of the CenterFreq attribute as specified in the UsTriggeredSpectrumCaptureCfg object.

#### 7.3.5.1.6.2.2 FreqSpan

A four-byte hexadecimal field containing the implemented value of the Span attribute as specified in the UsTriggeredSpectrumCaptureCfg object.

#### 7.3.5.1.6.2.3 NumBins

A two-byte hexadecimal field containing the implemented value of the NumBins attribute as specified in the UsTriggeredSpectrumCaptureCfg object.

#### 7.3.5.1.6.2.4 Averaging

A one-byte hexadecimal field containing the implemented value of the Averaging attribute as specified in the UsTriggeredSpectrumCaptureCfg object.

#### 7.3.5.1.6.2.5 SamplingRate

A two-byte hexadecimal field containing the sampling rate in Hertz for time IQ data.

#### 7.3.5.1.6.2.6 OutputFormat

A one-byte hexadecimal field containing the value of the OutputFormat attribute as specified in the UsTriggeredSpectrumCaptureCfg object.

#### 7.3.5.1.6.2.7 FileLen

A four-byte hexadecimal field representing the length in bytes of the upstream spectrum sample capture data which follow in the file.

#### 7.3.5.1.6.2.8 SampleData

The upstream spectrum sample capture data formatted according to the configured OutputFormat.

### 7.3.5.1.6.3 UsTriggeredSpectrumCaptureCfg Object

The Upstream Triggered Spectrum Capture Configuration object provides configuration functionality for the Upstream Triggered Spectrum Capture function.

The CCAP MUST provide a calibration constant per connector in dBmV that the PNM server can use to obtain the US spectrum capture estimate in dBmV/bin, at an agreed calibration point, such as the RF connector of the line card. Details for calculating and applying a calibration constant follow:

#### 1. Computing calibration constant

A single-carrier ATDMA QAM signal with the following characteristics is used for calibration:

- Symbol rate = 5.12 MHz
- Signal is present for the entire FFT sampling interval (i.e., not captured at the edge of a burst so only part of the FFT buffer contains signal)
- Signal level = 0 dBmV measured at the specified interface (e.g., RF connector of CCAP port)

The goal is to select the calibration constant such that after calibration, the sum of the linear power (not dB) values of all FFT bins in the 6.4 MHz occupied band of the above 0 dBmV test signal = 1 (i.e., 0 dB). This property will hold regardless of which resolution bandwidth or FFT window is selected. With this calibration, integrated power measurements (sum of linear power over a given spectral bandwidth) will give correctly calibrated results in dBmV for any collection of signals in the spectrum.

Let  $P_{raw}$  = sum of the linear power (not dB) values of all FFT spectrum bins in the 6.4 MHz occupied band of the signal before applying the calibration constant. Let  $P_0$  = average value of  $P_{raw}$  over several (e.g., 32) spectral captures, in order to reduce noise variation in the measurement.

Then the calibration constant in dB is computed as  $K = 10 \cdot \log_{10}(P_0)$ .

2. Applying calibration constant

To apply the calibration constant, the CCAP performs the following steps:

Start with the raw spectral value for a given FFT bin; let this be called  $D_{raw}$  (dB value),  $S_{raw}$  (linear power) or  $A_{raw}$  (amplitude) depending on the format of the measurement. Then the calibrated values are

$$D_{calibrated} = D_{raw} - K$$

$$S_{calibrated} = S_{raw} / P_0$$

$$A_{calibrated} = A_{raw} / \sqrt{P_0}$$

This calibration constant is applied by the CCAP to each FFT bin before reporting the spectrum results. The calibration constant may be different on different ports.

This object supports the creation and deletion of at least one instance.

The CCAP is not required to persist instances of this object across reinitializations.

**Table 7-112 - UsTriggeredSpectrumCaptureCfg Object**

Attribute Name	Type	Access	Type Constraints	Units	Default Value
Index	UnsignedInt	Key	N/A	N/A	N/A
ifIndex	InterfaceIndex	Key	N/A	N/A	N/A
LogicalChanIfIndex	InterfaceIndex	R/W	N/A	N/A	0
TriggerMode	Enum	R/W	other(1) freeRunning(2) miniSlotCount(3) sid(4) idleSid(5) cmMac(6) quietProbeSymbol(7) burstLuc(8) timestamp(9)	N/A	freeRunning
MinislotCount	UnsignedInt	R/W	N/A	N/A	0
Sid	UnsignedInt	R/W	N/A	N/A	0
CmMacAddr	MacAddress	R/W	N/A	N/A	'00000000 000'H
Timestamp	TimeStamp	R/W	N/A	N/A	0
CenterFreq	UnsignedInt	R/W	0 500000 - 208000000	Hz	0
Span	UnsignedInt	R/W	0 - 208000000	Hz	0
NumBins	UnsignedShort	R/W	0 2..2048	N/A	0
Averaging	UnsignedByte	R/W	0 2..255	N/A	0

Attribute Name	Type	Access	Type Constraints	Units	Default Value
Filename	AdminString	R/W	N/A	N/A	""
QualifyCenterFreq	UnsignedInt	R/W	N/A	Hz	0
QualifyBw	UnsignedInt	R/W	N/A	Hz	5120000
QualifyThrshld	Integer	R/W	N/A	dB	-100
Window	Enum	R/W	other(1), rectangular(2), hann(3), blackmanHarris(4), hamming(5), flatTop(6), gaussian(7), chebyshev(8)	N/A	rectangular
OutputFormat	Enum	R/W	timelQ(1), fftPower(2), rawAdc(3), fftIQ(4), fftAmplitude(5), fftDb(6)	N/A	fftPower
RepeatPeriod	UnsignedInt	R/W	N/A	usec	50000
FreeRunDuration	UnsignedInt	R/W	N/A	msec	1000
TriggerCount	UnsignedInt	R/W	N/A	N/A	0

#### 7.3.5.1.6.3.1 Index

This key attribute is a unique identifier for a particular set of configuration settings. If the CCAP does not support multiple Upstream Triggered Spectrum Sample Capture configuration settings, the CCAP MUST only support a value of 1 for this attribute and reject any attempt to configure it to a value other than 1.

#### 7.3.5.1.6.3.2 ifIndex

This key attribute is the interface index of an upstream RF port.

The CCAP MAY provide simultaneous measurements of logical upstream channels within a single upstream physical interface.

#### 7.3.5.1.6.3.3 LogicalChannelIfIndex

This attribute is the interface index of the logical channel to which the sample capture trigger applies, when TriggerMode is miniSlotCount, sid, idleSid, quietProbeSymbol, and burstIuc.

The value 0 means the CCAP is triggering on something specific to the upstream RF port, not a specific channel.

When the value of LogicalChannelIndex is the ifIndex of a physical or logical channel and upstream triggered spectrum sample capture is initiated, the CCAP MUST trigger on the assigned trigger mode event for the physical or logical channel indicated by the value of LogicalChannelIndex.

#### 7.3.5.1.6.3.4 TriggerMode

This attribute is used to control the trigger mode for the Upstream Triggered Spectrum Analysis sample capture. Values allowed for this attribute are listed and described below. Each trigger mode requires the Enable attribute to be set to true as well as the proper configuration settings applied that are applicable to the specific trigger mode.

**other:** The CCAP initiates sampling the upstream spectrum as the result of a trigger condition not defined in this specification.

**freeRunning:** The CCAP immediately initiates sampling and continues sampling until the length of time configured in attribute FreeRunDuration has transpired. Sampling terminates when the length of time

configured in FreeRunDuration has elapsed or when FFT is disabled. The interval between captures is RepeatPeriod, or the minimum period supported by the CCAP, whichever is greater.

**miniSlotCount:** The CCAP initiates sampling when the minislot number equals the value configured for attribute MiniSlotCount.

**sid:** The CCAP immediately initiates capturing samples corresponding to the Service Flow identified with the Service Identifier (SID) numbered with the value of attribute Sid. The CCAP continues to sample the configured upstream spectrum after being triggered on transmissions corresponding to the specified SID until FFT is disabled or a new configuration is applied.

**idleSid:** The CCAP immediately initiates capturing samples during an idle period selected by the CCAP. The CCAP will continue to sample the configured upstream spectrum during transmissions corresponding to the idle SID until FFT is disabled or a new configuration is applied.

**cmMacAddr:** The CCAP immediately initiates sampling data on a grant for any SID assigned to the cable modem whose MAC address is the value of attribute CmMac. The CCAP continues to sample the configured upstream spectrum during transmissions corresponding to the configured CM MAC until FFT is disabled or a new configuration is applied.

**quietProbeSymbol:** The CCAP immediately initiates sampling data when a configured OFDMA Quiet Probe Symbol occurs. The CCAP will continue to sample the configured upstream spectrum during Quiet Probe Symbols until FFT is disabled or a new configuration is applied.

The Upstream Triggered Spectrum Capture test with quietProbeSymbol trigger is different from the Upstream Capture for Active and Quiet Probes PNM feature in that the Upstream Triggered Spectrum Capture test is more general than the Upstream Capture for Active and Quiet Probes test. Upstream Triggered Spectrum Capture test can be done in any band, while the Upstream Capture for Active and Quiet Probes test is specifically for an OFDMA channel.

**burstIuc:** The CCAP immediately initiates sampling when the CCAP issues the grant for the configured burst Interval Usage Code. The CCAP will continue to sample the configured upstream spectrum during transmissions corresponding to the configured IUC until FFT is disabled or a new configuration is applied.

**timestamp:** The CCAP initiates sampling when the configured timestamp occurs. The CCAP will continue to sample the configured upstream spectrum until FFT is disabled or a new configuration is applied; however, a single capture typically is made in this mode. This is the DOCSIS 3.1 timestamp defined in [MULPIv3.1].

Note that if the CCAP supports only one set of Upstream Triggered Spectrum Capture configuration, then if a test is configured with timestamp trigger, it effectively blocks any other test setup and execution until it completes, since setting up the other test will overwrite the timestamp test configuration.

#### 7.3.5.1.6.3.5 MinislotCount

This attribute specifies the minislot number at the beginning of which the CCAP starts the upstream spectrum sample capture. This attribute is applicable only when the TriggerMode attribute is set to MiniSlotCount and is ignored if TriggerMode is set to any other value.

#### 7.3.5.1.6.3.6 Sid

This attribute specifies the SID corresponding to the CM which is granted a burst opportunity for the purpose of Upstream Triggered Spectrum Analysis.

This attribute is applicable only when the TriggerMode attribute is set to Sid and is ignored if TriggerMode is set to any other value.

#### 7.3.5.1.6.3.7 CmMacAddr

This attribute specifies from which cable modem the CCAP will capture upstream transmissions.

The CCAP MUST trigger upstream spectrum sample capture on a grant for any SID assigned to the CM whose MAC address is configured in CmMacAddr, and capture upstream spectrum samples when the burst corresponding

to that grant is received by the CCAP. This attribute is used when the TriggerMode is CmMac and is an alternative to using Sid for the TriggerMode. This attribute is ignored if TriggerMode is set to any value other than CmMac.

#### 7.3.5.1.6.3.8 Timestamp

This attribute specifies the specific time in the future when upstream spectrum sample capture is required to be initiated. If Enable is true, TriggerMode is set to timestamp, configuration settings have been applied, and InitiateTest is true, the CCAP MUST initiate sampling when the configured timestamp occurs. The CCAP will continue to sample the configured upstream spectrum until FFT is disabled or a new configuration is applied; however, a single capture typically is made in this mode.

#### 7.3.5.1.6.3.9 CenterFreq

This attribute specifies the center frequency of the upstream spectrum to be sampled for analysis. When this attribute is read, it provides the actual center frequency, which may be different from the requested (configured) center frequency due to implementation effects.

#### 7.3.5.1.6.3.10 Span

This attribute determines the frequency span of the upstream spectrum sample capture. When this attribute is read, it provides the actual span, which may be different from the requested (configured) span due to implementation effects.

#### 7.3.5.1.6.3.11 NumBins`

This attribute determines the number of frequency bins or samples per span when sampling the upstream spectrum. When this attribute is read, it provides the actual number of bins, which may be different from the requested (configured) number of bins due to implementation effects. The number of bins is typically less than the FFT length in use, due to filter rolloff at the edges of the analysis band. A larger number of frequency bins will result in better frequency resolution for a given frequency span.

#### 7.3.5.1.6.3.12 Averaging

This attribute specifies whether the CCAP is to average spectral frequency domain sample power to remove spurious spectral peaks and troughs, and the number of samples to use to calculate the average power.

The CCAP MUST NOT calculate the average of the upstream spectrum samples when the value of Averaging is zero.

The CCAP MUST calculate the average power of upstream spectrum samples, over the number of samples specified, when the value of the Averaging attribute is non-zero.

The CCAP MUST use quantities in the linear power domain when performing time averaging over multiple spectra. Time averaging provides for a smoother resulting spectrum. In time averaging, the spectrum is captured multiple times, and each FFT bin is averaged over the successive values in that bin to provide the final spectrum value for that bin. A leaky integrator may be used to perform the averaging. Let  $x = x_I + j*x_Q$  be the vector of time domain input samples to the FFT and  $y = y_I + j*y_Q$  be the vector of complex output frequency bin values of the FFT. Then  $p = |y|^2 = y_I^2 + y_Q^2$  is the power or squared magnitude of the bin values and  $r = |y| = \sqrt{y_I^2 + y_Q^2}$  is the magnitude of the bin values. The values may be converted to dB using  $s = 10*\log_{10}(p) = 20*\log_{10}(r)$ . Only values of  $p$  are used for time averaging. Magnitude values need to be squared before averaging. dB values need to be converted into linear power using  $p = 10^{(s/10)}$  before averaging; after averaging, the smoothed bin values may be converted back to dB.

#### 7.3.5.1.6.3.13 Filename

This attribute specifies the name of the file with the upstream triggered spectrum capture data at the CCAP that is to be transferred from the CCAP using TFTP to the PNM server or other TFTP client. The content of the sample data file transferred from the CCAP using TFTP is the same as the content returned in attribute Output of the corresponding Result object.

If the value of this attribute is an empty string, then a default filename value will be used. Otherwise, the value set will be used as the filename. If a default filename is generated, then that value will be returned in this attribute and will represent the filename that was used for the test. All subsequent tests should set this attribute to a meaningful value or to an 'empty string' value (to generate a new default filename) before starting a new test.

If a default filename value is used, it is generated as the test name, plus a unique CCAP identifier (either a loopback address (IPv4 or IPv6) or FQDN), plus the 'epoch time'. The epoch time (also known as 'unix time') is defined as the number of seconds that have elapsed since midnight Coordinated Universal Time (UTC), Thursday, 1 January 1970.

Hence, the format would be:

PNMCcapUsSpecAn\_<Unique CCAP Identifier>\_<epoch>, where

Hence, the upstream spectrum sample capture filename format would be as shown in the following example:

PNMCcapUsSpecAn\_ccap1.boulder.cablelabs.com\_1403405123

Format of upstream triggered spectrum capture file is described in section 7.3.5.1.6.2.

#### **7.3.5.1.6.3.14 QualifyCenterFreq**

This attribute specifies the center frequency of a band that is used to qualify a spectrum for upload. The average of the FFT linear power values in this band is computed and compared to a threshold. If the average power in the band is below the threshold, the spectrum is discarded. If the power average is greater than or equal to the threshold, the spectrum is considered qualified.

#### **7.3.5.1.6.3.15 QualifyBw**

This attribute specifies the bandwidth of a band that is used to qualify a spectrum for upload. The average of the FFT linear power values in this band is computed and compared to a threshold. If the average power in the band is below the threshold, the spectrum is discarded. If the power average is greater than or equal to the threshold, the spectrum is considered qualified.

#### **7.3.5.1.6.3.16 QualifyThrshld**

This attribute specifies the threshold applied to qualify a spectrum for upload. The average of the FFT linear power values in the specified band is computed and compared to this threshold. If the average power in the band is below the threshold, the spectrum is discarded. If the power average is greater than or equal to the threshold, the spectrum is considered qualified. If this threshold is set to -100 dB or lower, the threshold qualification feature is disabled (all spectra are then considered qualified).

#### **7.3.5.1.6.3.17 Window**

This attribute specifies the windowing function that will be used when performing the discrete Fourier transform for the upstream spectrum analysis. Use of "modern" windowing functions not yet defined will likely be specified as 'other'.

The CCAP MUST be capable of implementing rectangular windowing and at least one of the following other window types when performing discrete Fourier transform on upstream spectrum sample data:

- Hann windowing
- Blackman Harris windowing.

The CCAP SHOULD implement Hamming windowing for performing discrete Fourier transform on upstream spectrum sample data.

The CCAP MAY implement Flat Top windowing for performing discrete Fourier transform on upstream spectrum sample data.

The CCAP MAY implement Gaussian windowing for performing discrete Fourier transform on upstream spectrum sample data.

The CCAP MAY implement Chebyshev windowing for performing discrete Fourier transform on upstream spectrum sample data.

#### **7.3.5.1.6.3.18 OutputFormat**

This attribute specifies the format of the data returned in the upstream spectrum sample capture file and in the Output attribute of the Results object.

The CCAP MUST be capable of reporting upstream spectrum sample FFT input data in complex time-domain in-phase and quadrature (I/Q) format. The enumeration value for complex time-domain I/Q format is timeIQ.

The CCAP MUST use 4 bytes per upstream spectrum sample to represent the data when reporting in complex time-domain I/Q format.

The CCAP MUST be capable of reporting upstream spectrum sample FFT output data in power format. The enumeration value for power format is fftPower.

The CCAP MUST use 4 bytes per bin to represent upstream spectrum sample FFT output data when reporting upstream spectrum sample data in power format.

The CCAP MAY be capable of reporting upstream spectrum sample real FFT input data in raw analog-to-digital converter (ADC) output format. The enumeration value for raw ADC output format is rawAdc.

The CCAP MUST use 2 bytes per upstream spectrum sample to represent the data when reporting in raw ADC output format.

The CCAP MAY support reporting of upstream spectrum sample FFT output data in I/Q format. The enumeration value for I/Q format is fftIQ.

The CCAP MUST use 4 bytes per bin to represent FFT output data when reporting upstream spectrum sample data in I/Q format.

The CCAP MAY support reporting of upstream spectrum sample FFT output data in amplitude format. The enumeration value for amplitude format is fftAmplitude.

The CCAP MUST use 2 bytes per bin to represent upstream spectrum sample FFT output data when reporting upstream spectrum sample data in amplitude format.

The CCAP MAY support reporting of upstream spectrum sample FFT data in dB format using units of hundredths dB. The enumeration value for spectrum amplitude format is fftDb.

The CCAP MUST use 2 bytes per bin to represent upstream spectrum sample FFT output data when reporting in dB format.

The CCAP MUST reject any attempt to set OutputFormat to an optional value not supported by the CCAP.

#### **7.3.5.1.6.3.19 RepeatPeriod**

This attribute specifies the interval in microseconds between consecutive triggers for FFT sample capture. The CCAP is permitted to trigger at larger intervals if unable to support the requested interval. Configuring a zero value indicates the test is to run once only.

The CCAP MUST reject an attempt to set RepeatPeriod to a value greater than the current value of FreeRunDuration.

#### **7.3.5.1.6.3.20 FreeRunDuration**

This attribute specifies the length of time in milliseconds for which the CCAP continues to capture and return FFT results when in free running mode.

Sample captures are expected to take a few microseconds, so if FreeRunDuration is set for longer than a sample capture duration, the CCAP could potentially capture more sample data than it can store.

The CCAP MUST reject an attempt to set FreeRunDuration to a value less than the current value of RepeatPeriod.

**7.3.5.1.6.3.21 TriggerCount**

This attribute determines the number of times to trigger upstream spectrum sample capture when Enable and InitiateTest are set to true and configured trigger conditions are met.

The CCAP MUST trigger upstream spectrum sample capture continuously when the value of TriggerCount is zero.

This attribute is applicable to FreeRun trigger modes as well as other trigger modes.

**7.3.5.1.6.4 UsTriggeredSpectrumCaptureCtrl Object**

The Upstream Triggered Spectrum Capture Control object provides command and control functionality for the Upstream Triggered Spectrum Capture function.

This object supports the creation and deletion of multiple instances. Instances are created and/or deleted when the corresponding UsTriggeredSpectrumCaptureCfg object instances are instantiated.

The CCAP is not required to persist instances of this object across reinitializations.

**Table 7-113 - UsTriggeredSpectrumCaptureCtrl Object**

Attribute Name	Type	Access	Type Constraints	Units	Default Value
InitiateTest	Boolean	R/W	N/A	N/A	False

**7.3.5.1.6.4.1 InitiateTest**

This attribute is used to trigger an Upstream Triggered Spectrum Capture. Setting this attribute to true applies all configured upstream triggered spectrum sample capture attributes and initiates the triggered upstream spectrum sample capture and sample output conversion process.

Read-write attributes, which are used to configure the Upstream Triggered Spectrum Capture, can only be configured while a test is not in progress.

The CCAP MUST reject any attempt to modify a UsTriggeredSpectrumCaptureCfg Object attribute, or UsTriggeredSpectrumCaptureCtrl Object attribute for the same instance of InitiateTest configured to true when the triggered spectrum capture is in progress as indicated by value 'busy' for MeasStatus.

The CCAP MUST allow writable UsTriggeredSpectrumCaptureCfg Object attributes or UsTriggeredSpectrumCaptureCtrl Object attributes to be modified if the value of attribute MeasStatus for the instance is not 'busy'.

The CCAP initiates an upstream triggered spectrum sample capture only if Enable bit 1 is set to true, InitiateTest is set to true and all of the UsTriggeredSpectrumCaptureCfg configuration objects are properly configured. Refer to Section 7.3.5.1.6 and Table 7-109.

While a test is in progress, this attribute returns the value true. Configuring a value of false for this attribute, while a test is in progress, will abort the currently executing test. If a test is aborted, the result data is discarded.

**7.3.5.1.6.5 UsTriggeredSpectrumCaptureStatus Object**

The Upstream Triggered Spectrum Capture Status object provides functionality for monitoring and reporting status of the Upstream Triggered Spectrum Capture function.

This object supports the creation and deletion of multiple instances. Instances are created and/or deleted when the corresponding UsTriggeredSpectrumCaptureCfg object instances are instantiated.

The CCAP is not required to persist instances of this object across reinitializations.



**Table 7-114 - UsTriggeredSpectrumCaptureStatus Object**

Attribute Name	Type	Access	Type Constraints	Units	Default Value
MeasStatus	MeasStatusType	R/O	N/A	N/A	N/A

**7.3.5.1.6.5.1 MeasStatus**

This attribute is used to report the status of the Upstream Triggered Spectrum Capture. When the value of MeasStatus is sampleReady, the CCAP has completed capturing and recording samples.

**7.3.5.1.6.6 UsTriggeredSpectrumCaptureResult Object**

The Upstream Triggered Spectrum Capture Result object provides functionality for reporting results of the Upstream Triggered Spectrum Capture function.

This object supports the creation and deletion of multiple instances. Instances are created and/or deleted when the corresponding UsTriggeredSpectrumCaptureCfg object instances are instantiated.

The CCAP is not required to persist instances of this object across reinitializations.

**Table 7-115 - UsTriggeredSpectrumCaptureResult Object**

Attribute Name	Type	Access	Type Constraints	Units	Default Value
SampleRate	UnsignedInt	R/O	N/A	Samples per second	N/A
UsSampleSize	UnsignedInt	R/O	N/A	Samples	N/A
SampleTimestamp	TimeStamp	R/O	N/A	TimeTicks	N/A
ResolutionBw	UnsignedInt	R/O	N/A	Hertz	N/A
Output	HexBinary	R/O	N/A	N/A	N/A

**7.3.5.1.6.6.1 SampleRate**

This attribute reports the FFT sample rate used by the CCAP when sampling the upstream spectrum. The input to the FFT can be the ADC output, the ADC output followed by a down-mixer and half-band filter, the ADC output followed by a down-mixer and quarter-band filter, or the received channel's Nyquist filter output.

**7.3.5.1.6.6.2 UsSampleSize**

This attribute reports the number of samples collected for FFT. The FFT payload size will be the number of samples multiplied by the number of bytes per sample as determined by OutputFormat. The duration of the FFT sample will be the number of samples divided by the sample rate as reported in attribute SampleRate.

**7.3.5.1.6.6.3 SampleTimestamp**

This attribute reports the date and time when the FFT sample was recorded.

**7.3.5.1.6.6.4 ResolutionBw**

This attribute reports the resolution bandwidth used when samples were collected. The resolution bandwidth is the same as the bin spacing for rectangular windowing, is 1.5\*bin spacing for Hanning window, etc. The resolution bandwidth used by the CCAP is needed in order to obtain an accurate power measurement for all signals when both CW and noise-like (QAM, OFDM) signals are present in the spectrum.

**7.3.5.1.6.6.5 Output**

This attribute returns the upstream spectrum sample capture data in hexadecimal format according to the output format configured in attribute OutputFormat. The format of the sample capture data returned by this attribute is as described in Section 7.3.5.1.6.2. This attribute provides an alternative to TFTP file transfer for reporting sample

data. Due to small data sizes for upstream captures, this may be a more responsive method for screen updates than TFTP file transfer.

The CCAP MUST create a row in the UsSpectrumAnalysis table for each IfIndex of an upstream RF Port.

**7.3.5.1.7 SpectrumAnalysisMeas<sup>207</sup>**

This object is included here for reference, and is defined in Section 6.7.1.2.2.

**7.3.6 CCAP Bulk Data Transfer<sup>208</sup>**

Proactive Network Maintenance, and potentially other applications, may generate data files that need to be transferred to a server. The Bulk Data Transfer mechanism defines file storage requirements, destination address and a mechanism to initiate a transfer. The transfer of the bulk data file may be initiated automatically on file creation or on demand. This section defines the Bulk Data capability requirements.

**7.3.6.1 CCAP Bulk Data Transfer Requirements**

The CCAP MUST act as a TFTP client and implement the TFTP protocol over UDP per [RFC 1350] to transfer Bulk-Data files.

The CCAP MUST initiate the TFTP connection on the standard TFTP-assigned port (69).

The CCAP MUST use the 'octet' TFTP transfer mode to perform a TFTP 'write' to the specified address.

The CCAP MUST include the TFTP Blocksize option [RFC 2348] when establishing a TFTP connection.

The CCAP MUST request a blocksize of 1448 if using TFTP over IPv4. The CCAP MUST request a blocksize of 1428 if using TFTP over IPv6.

The CCAP is not required to keep track of which Bulk-Data files have been uploaded to the management system. If the Bulk-Data TFTP transfer process fails, the docsPnmBulkUploadStatus attribute MUST be set to reflect the error. In this case, the CCAP is only required to report that an error occurred. The CCAP MUST change the value of the UploadStatus attribute to reflect the status of the upload. There are no requirements for the CCAP to automatically retry the transfer.

**7.3.6.2 Data-File and Storage Requirements**

The CCAP MUST retain Bulk Data files in the allocated memory unless it is commanded to delete the file, or the file is overwritten with a new file. The CCAP MAY retain the Bulk Data files across reboot or reset or power cycle.

**7.3.6.3 Bulk Data Objects**

This section defines objects that are used to manage the Bulk-Data files that the CCAP (referred to here as the "device") has been commanded to capture.

**7.3.6.3.1 CCAPBulkDataControl Object**

This object provides the configuration attributes needed for the device to upload Bulk Data files to a Server.

**Table 7-116 - CcapBulkDataControl Object**

Attribute Name	Type	Access	Type Constraints	Units	Default
DestIpAddr	InetAddress ([RFC 4001])	R/W	N/A	N/A	"" (empty string)

<sup>207</sup> Modified per CCAP-OSSv3.1-N-16.1490-2 on 5/13/16 by KB.

<sup>208</sup> This section and subsections modified by CCAP-OSSv3.1-N-15.1250-2 on 3/3/15 by KB.

Attribute Name	Type	Access	Type Constraints	Units	Default
DestIpAddrType	InetAddressType ([RFC 4001])	R/W	unknown(0) ipv4(1) ipv6(2)	N/A	unknown
DestPath	AdminString	R/W	N/A	N/A	"" (empty string)
UploadControl	enum	R/W	other(1) noAutoUpload(2) autoUpload(3)	N/A	autoUpload

#### 7.3.6.3.1.1 DestIpAddr

This attribute represents the IP address of the PNM server to which the bulk data file is to be sent. This attribute is further defined by the DestIpAddrType attribute.

#### 7.3.6.3.1.2 DestIpAddrType

This attribute represents the IP address type of the DestIpAddr attribute. This value is of type InetAddressType which is defined by [RFC 4001].

A successful connection depends on the value of this attribute being set to an IP Family supported by the device. For example, if this value is set to IPv6 and the device is operating in IPv4-only mode, a successful upload will not be possible. In this case, the UploadStatus attribute in the BulkDataFile object would reflect the error.

#### 7.3.6.3.1.3 DestPath

This attribute represents the path, excluding the filename, at the PNM server to which the bulk data file is to be sent. By default, the value of this object is an empty string. If used, this value includes all expected delimiters. The following examples, excluding the quotes, are valid values:

"/Directory1/directory2/"

"/pnm/"

#### 7.3.6.3.1.4 UploadControl

This attribute controls the action taken by the device when a new bulk data file is generated. The possible values are defined below.

**noAutoUpload** - Bulk Data files are not automatically uploaded by the device. All bulk data files are available to be uploaded, on demand, by manipulating the FileControl attribute in the BulkDataFile object for that file's row instance.

**autoUpload** - When the autoUpload option is selected, the CCAP MUST automatically upload bulk data files as they become available. A file becomes available when a file-generation application completes the file and creates a row in the BulkDataFileTable. If this value is set, the bulk data file is automatically uploaded to the parameters defined by the DestIpAddr, DestIpAddrType, and DestPath. If the upload fails or additional uploads are desired, the file can be re-uploaded by manipulating the FileControl attribute in the BulkDataFile object for that file's row instance.

#### 7.3.6.3.2 CcapBulkDataFile Object

This table provides the attributes needed for the device to upload a bulk data file to the Server. This object is a table with a row for each file that is available, in the device, for upload. The parameters used for the upload are provided under the BulkDataControl object. The CCAP MUST create a row for each file that is available for upload. The device could have limited resources to save captured data files. Therefore, if the number of files exceeds the minimum supported number of files requirements for the device, newly created rows can overwrite/replace existing rows as new data files become available. If a bulk data file is no longer available for upload, the CCAP MUST remove that file's details from the BulkDataFile table.

**Table 7-117 - CcapBulkDataFile Object**

Attribute Name	Type	Access	Type Constraints	Units	Default
FileIndex	UnsignedByte	Key	N/A	N/A	N/A
FileName	AdminString	R/O	N/A	N/A	N/A
FileControl	Enum	R/W	other(1) tftpUpload(2) cancelUpload(3) deleteFile (4)	N/A	other
UploadStatus	Enum	R/O	other(1) availableForUpload(2) uploadInProgress(3) uploadCompleted(4) uploadPending(5) uploadCancelled(6) error(7)		

**7.3.6.3.2.1 FileIndex**

This attribute is the key for the table.

**7.3.6.3.2.2 FileName**

This attribute contains the name of the bulk data file stored in the device, that is available to be uploaded to the server. Filenames are defined by the application that creates them.

**7.3.6.3.2.3 FileControl**

This attribute controls the action taken by the device regarding the file specified by the FileName attribute. When a value is written to this attribute for a given row instance, the device is required to take that action on the specified bulk data file. The possible actions are listed:

other(1) - This value is returned when the object is read. This value is not writeable.

tftpUpload(2) - The CCAP MUST initiate a TFTP-Write to the server with the parameters specified in the 'DestIpAddr', 'DestIpAddrType', and 'DestPath' attributes. This action will change the value of the UploadStatus attribute to 'uploadInProgress' while the transfer is ongoing. This object can only be set to 'tftpUpload' when the value of the 'UploadStatus' attribute is not set to a value of 'uploadInProgress' for this row OR for any row in the table. This limits the upload process to one upload at a time. This object will return 'inconsistentValue' for this case.

cancelUpload(3) - The CCAP MUST cancel a pending upload or an upload currently in progress on this bulk data file. The value of the UploadStatus attribute will be changed to 'uploadCancelled'.

deleteFile (4) - The CCAP MUST delete the file from its memory and from this table. This object cannot be set to deleteFile(4) while an upload is in progress.

**7.3.6.3.2.4 UploadStatus**

This attribute reflects the status of the bulk data file. The possible values are listed below.

other(1) - Any condition not covered by the other defined values.

availableForUpload(2) - The file is available to be uploaded.

uploadInProgress(3) - The file is currently being uploaded.

uploadCompleted(4) - The file was successfully uploaded.

uploadPending(5) - The file has been selected for upload but a condition does not allow the upload to take place. The upload will start when the condition blocking uploads has been removed. For example, another upload that is currently in progress could cause this value to be returned.

uploadCancelled(6) - An upload was cancelled before it completed.

error(7) - An error occurred and the file was not successfully uploaded.

### 7.3.7 Triggering OPT Messages<sup>209</sup>

To support the requirements of an external application managing DOCSIS OFDM channel profiles, a capability is needed for triggering the DOCSIS OPT message to retrieve various channel and profile related metrics and perform various tests as defined in [MULPIv3.1]. A triggering mechanism is defined to trigger the CMTS to send an OPT Request (OPT-REQ) message and then return CM metric information from the OPT Response (OPT-RSP) message. Note that the tests that return a given profile's MER per subcarrier data will be larger than a single SNMP PDU can transport in a single Ethernet frame.

The OFDM Profile Test (OPT) is performed using MAC Management Message (MMM) provided to evaluate several different parameters associated with a Downstream OFDM profile that is not currently being used by a target CM.

An OPT is requested by the CMTS through the generation of a OPT-REQ message to the CM required to perform the test. The CM performs the OPT using the parameters described in the OPT-REQ message. Upon successful completion of the test, the CM returns the OPT results in the OPT-RSP message.

The OPT message exchange is designed to support the following:

- Retrieval of the per-subcarrier MER values from the CM, which is a channel level measurement
- Compilation by the CM for codeword statistics including codeword counts, uncorrectable codeword counts, and the ability to enable codeword tagging
- Execution of NCP Profile tests, which include the NCP Field counts and NCP CRC failure counts

When the CM receives an OPT Request message it may contain one or more of the aforementioned tests. The CM will use the OPT Response message to return the tested values to the CMTS.

---

<sup>209</sup> Added per CCAP-OSSiv3.1-N-16.1506-2 on 5/16/16 by KB.

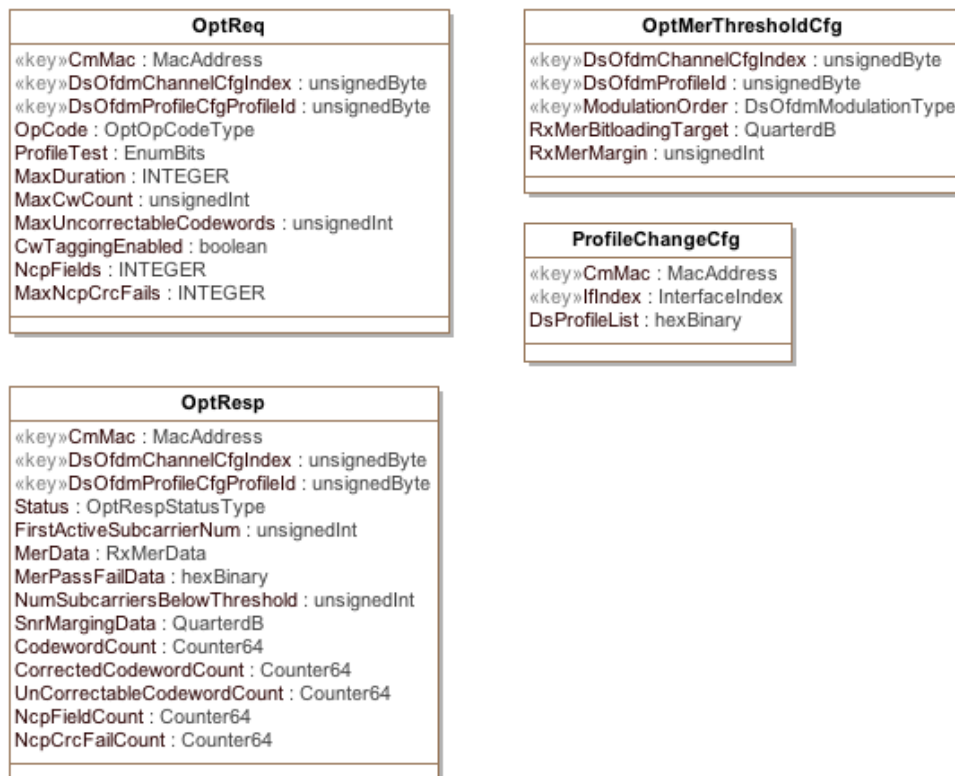

Figure 7-26 - CCAP OPT PNM Information Model

7.3.7.1 OptReq Object

The OPT Request object is used to initiate the OPT-REQ message for a given OFDM DS channel. The message and resulting tests and requirements are defined in the OPT-REQ TLV Encodings section of [MULPIv3.1]. To use the object, the Operator or PMA Application uses the CM MAC address, the DsOfdmChannelCfgIndex, DsOfdmProfileCfgProfileId as the key to initiate a test. The specific tests that are defined in MULPI are accessed with the ProfileTest attribute. This attribute is a BITS data type and will allow one or more of the OPT tests to be configured to be performed by the CM. Due to the nature of the ProfileTest attribute, one or more tests can be requested in a single message and thus different amounts of data need to be configured in order for the OPT Message to have the required TLVs. The following table depicts this.

Table 7-118 - Profile Tests

ProfileTest	Test Description	Required Attributes
Bit 0 - RxMER Statistics per Subcarrier	Per subcarrier MER regardless of modulation or profile	CmMac, DsOfdmChannelIndex, DsProfileId
Bit 1 - RxMER per Subcarrier Threshold Comparison for Candidate Profile	When this test is selected, the CM uses MER target values for each modulationOrder in the candidate Profile referenced in DsProfileId. Target values are configured in the OptMerThresholdCfg with RxMERvsBitloadingTarget	CmMac, DsOfdmChannelIndex, DsProfileId, Test requires that one or more instances of OptMerThresholdCfg exist for the referenced CmMac, DsOfdmChannelIndex, DsProfileId,
Bit 2 - SNR Margin for Candidate Profile	When this test is selected, the CM uses the threshold values in the OptMerThresholdCfg for the specified DsOfdmChannelIndex, DsProfileId, ModulationOrder and the RxMERvsBitloadingTarget from the OptMerThresholdCfg	CmMac, DsOfdmChannelIndex, DsProfileId, Test requires that one or more instances of OptMerThresholdCfg exist for the referenced CmMac, DsOfdmChannelIndex, DsProfileId, ModulationOrder and that RxMerMargin is set to a non-zero value

ProfileTest	Test Description	Required Attributes
Bit 3 - Codeword Statistics for Candidate Profile	When this test is selected, the CM provides Codeword Statistics for the candidate profile	CmMac, DsOfdmChannelIndex, DsProfileId, MaxDuration, MaxCodewordCount and optionally MaxUncorrectedCw and CwTagging
Bit 4 - Codeword Threshold Comparison for Candidate Profile	When this test is selected, the CM provides Codeword Statistics for the candidate profile	CmMac, DsOfdmChannelIndex, DsProfileId, MaxDuration, MaxCodewordCount and optionally MaxUncorrectedCw and CwTagging
Bit 5 - NCP Field statistics	When this test is selected, the CM provides NCP Statistics for the candidate profile	CmMac, DsOfdmChannelIndex, DsProfileId, MaxDuration, NcpFieldCount, and optionally MaxNcpCrcFailCount and CwTagging
Bit 6 - NCP CRC Threshold Comparison	When this test is selected, the CM provides NCP Statistics for the candidate profile	CmMac, DsOfdmChannelIndex, DsProfileId, MaxDuration, NcpFieldCount, and optionally MaxNcpCrcFailCount and CwTagging

Some of these tests perform evaluations of thresholds or margins. To facilitate these evaluations by the CM, these values are defined in the test request or the OptMerThresholdCfg object defined later in this section.

To successfully initiate a test, the DsOfdmChannelCfgIndex and an associated DsOfdmProfileCfgProfileId are required. The CCAP MUST reject a request to initiate an OPT test when the DsOfdmChannelCfgIndex does not exist or is not currently in use by the CM. The CCAP MUST reject a request if the referenced DsOfdmProfileCfgProfileId is in use on the CM or the value does not exist in the profiles associated with the referenced DsOfdmChannelCfgIndex. The CCAP MUST reject a request to run an OPT test on CM that is not operational. The CCAP MUST reject a request to run an OPT test when there are no entries in the OptMerThresholdCfg object for the DsOfdmChannelCfgIndex and associated DsOfdmProfileCfgProfileId, ModulationOrder defined in the DsProfileId being tested.

This object supports the creation and deletion of multiple instances.

**Table 7-119 - OptReq Attributes**

Attribute Name	Type	Access	Type Constraints	Units	Default Value
CmMac	MacAddress	Key			
DsOfdmChannelCfgIndex	UnsignedByte	Key			
DsOfdmProfileCfgProfileId	UnsignedByte	Key	0..15   255		
OpCode	OptOpCodeType	R/W	other(1), start(2), abort(3)		other(1)
ProfileTest	EnumBits	R/W	rxMerSubCarrierStats(0), rxMerSubCarrierThreshComp(1), snrMarginCandidateProfile(2), codewordStats(3), codewordThreshComp(4), ncpFieldStats(5), ncpCrcThreshComp(6), reserved(7), other(8)		
MaxDuration	Integer	R/W	4 Bytes	milliseconds	Need a smart default for this
MaxCodewords	unsignedInt	R/W	4 Bytes	Number of codewords	Need a smart default for this
MaxUncorrectableCodewords	unsignedInt	R/W	4 Bytes	Number of codewords	
CodewordTaggingEnabled	Boolean	R/W			false(0)
NcpFields	Integer	R/W	4 Bytes		
MaxNcpCrcFails	Integer	R/W	4 Bytes		

#### 7.3.7.1.1 *CmMac*

This key represents the MAC address for the referenced CM.

Reference: [MULPIv3.1] OPT-REQ TLV Encodings

#### 7.3.7.1.2 *DsOfdmChannelCfgIndex*

This key represents an instance of the *DsOfdmChannelCfg* of the Downstream OFDM channel that is currently assigned to a CM.

Reference: [MULPIv3.1] OPT-REQ TLV Encodings

#### 7.3.7.1.3 *DsOfdmProfileCfgProfileId*

This key is the targeted profile being tested with OPT for the instance of *DsOfdmChannelCfgIndex*. For Data Profile testing, the ID of the profile that is being tested is used. The value 254 is used for RxMER statistics only. The value 255 is used for NCP Profile Testing.

Reference: [MULPIv3.1] OPT-REQ TLV Encodings

#### 7.3.7.1.4 *OpCode*

This attribute controls the testing to be performed by the CM receiving the OPT-REQ message. This attribute is defined to mirror the *OpCode* field in the OPT-REQ message defined in the MULPI Spec.

Reference: [MULPIv3.1] OPT-REQ TLV Encodings

#### 7.3.7.1.5 *ProfileTest*

This attribute defines which of the OPT tests are to be run by the CM. The tests are encoded as individual bits:

- rxMerSubCarrierStats(0),
- rxMerSubCarrierThreshComp(1),
- snrMarginCandidateProfile(2),
- codewordStats(3),
- codewordThreshComp(4),
- ncpFieldStats(5),
- ncpCrcThreshComp(6),
- reserved(7),
- other(8)

When a given bit is set, then that test will be performed by the CM. Note that the tests *rxMerSubCarrierThreshComp(1)*, *snrMarginCandidateProfile(2)* require entries in the *OptMerThreshold* object for these tests to be performed.

This attribute corresponds to TLV 1 in the OPT Request message.

Reference: [MULPIv3.1] OPT-REQ TLV Encodings

#### 7.3.7.1.6 *MaxDuration*

This attribute allows the tester to determine how long a test may run before returning results or aborting.

This attribute corresponds to TLV 4 in the OPT Request message.

Reference: [MULPIv3.1] OPT-REQ TLV Encodings

#### 7.3.7.1.7 *MaxCodewords*

This attribute defines the maximum number of codewords that the CM should examine before the test is complete. When either *Nc* or more codewords have been received, or *Ne* or more codeword errors have occurred, since the start of the test, the CM will send an OPT-RSP with a Complete status.



This attribute is only present in the OPT-REQ message for Codeword tests: codewordStats(3), codewordThreshComp(4).

This attribute corresponds to TLV 5.1 in the OPT Request message.

Reference: [MULPIv3.1] OPT-REQ TLV Encodings

#### **7.3.7.1.8 MaxUncorrectableCodewords**

This attribute defines the maximum number of uncorrectable codewords that the CM should allow before the test is complete. When either Nc or more codewords have been received, or Ne or more codeword errors have occurred, since the start of the test, the CM will send an OPT-RSP with a Complete status.

This attribute is only present in the OPT-REQ message for Codeword tests: codewordStats(3), codewordThreshComp(4).

This attribute corresponds to TLV 5.2 in the OPT Request message.

Reference: [MULPIv3.1] OPT-REQ TLV Encodings

#### **7.3.7.1.9 CodewordTaggingEnabled**

This attribute indicates whether Codeword Tagging is in use for this test. This attribute is defined as a Boolean with the value 'false' meaning that codeword tagging is disabled and a value of 'true' meaning that codeword tagging is enabled. When codeword tagging is enabled, The CM will report codeword counts that include only codewords received on the profile in question for the duration of the test for which the 'T' bit is set to 1 in the NCP pointing to the codeword. The location of the 'T' bit is specified in [PHYv3.1].

If codeword tagging is disabled, the CM only reports codeword counts that include all codewords received on the profile in question for the duration of the test.

This attribute is only present in the OPT-REQ message for Codeword tests: codewordStats(3), codewordThreshComp(4).

This attribute corresponds to TLV 5.3 in the OPT Request message.

Reference: [MULPIv3.1] OPT-REQ TLV Encodings

#### **7.3.7.1.10 MaxNcpFields**

This attribute defines the maximum number of NCP fields to be examined during the test. When the CM has examined this number or more NCP fields, it returns the OPT Request with a completed test status and the collected statistical information.

This attribute is only present in the OPT-REQ message for NcpFieldTests: ncpFieldStats(5), ncpCrcThreshComp(6).

This attribute corresponds to the TLV 6.1 in the OPT-REQ.

Reference: [MULPIv3.1] OPT-REQ TLV Encodings

#### **7.3.7.1.11 MaxNcpCrcFails**

This attribute defines the maximum number of NCP fields that are allowed to fail the NCP CRC checks to be examined during the test. When the CM has examined this number or more NCP fields, it returns the OPT Request with a completed test status and the collected statistical information.

This attribute is only present in the OPT-REQ message for NcpFieldTests: ncpFieldStats(5), ncpCrcThreshComp(6).

This attribute corresponds to the TLV 6.2 in the OPT-REQ.

Reference: [MULPIv3.1] OPT-REQ TLV Encodings

### **7.3.7.2 OptMerThresholdCfg**

For MER tests that require Pass/Fail criteria, it is necessary to define the parameters in a separate fashion as the OPT-REQ message needs these values on a per modulation basis. This means that for each modulation order defined in a profile, the OPT-REQ includes a TLV entry for the required MER target value for each. The CCAP MAY auto populate the OptMerThresholdCfg table when a new DsOfdmChannel or DsOfdmProfile is added to the CCAP. If

the CCAP creates instances of this object, the CCAP MUST create an instance of this object for every combination of DsOfdmChannelCfgIndex, DsOfdmProfileCfgProfileId and ModulationOrder defined in that profile. Attempts to create an instance of this object that do not reference a current instance of either of DsOfdmChannelCfgIndex, DsOfdmProfileCfgProfileId and ModulationOrder MUST be rejected by the CCAP. If the row creation is initiated with SNMP, the CCAP MUST return a no such object when attempts to create an instance of this object that do not reference a current instance of either of DsOfdmChannelCfgIndex or DsOfdmProfileCfgProfileId. The CCAP MUST reject a request that includes a DsProfileId value of 255 as this value indicates the NCP profile.

This object supports the creation and deletion of multiple instances.

**Table 7-120 - OptMerThresholdCfg Attributes**

Attribute Name	Type	Access	Type Constraints	Units	Default Value
DsOfdmChannelCfgIndex	UnsignedByte	Key			
DsOfdmProfileCfgProfileId	UnsignedByte	Key	0..15   255		
ModulationOrder	DsOfdmModulation Type	Key	other(1) zeroBitLoaded(2) qpsk(3) qam16(4) qam64(5) qam128(6) qam256(7) qam512(8) qam1024(9) qam2048(10) qam4096(11) qam8192 (12) qam16384 (13)		
RxMerVsBitloadingTarget	QuarterdB	R/W		QuarterdB	See CM Minimum CNR Performance in AWGN Channel [PHYv3.1] for default values
RxMerMargin	unsignedInt	R/W		dB	

**7.3.7.2.1 DsOfdmChannelCfgIndex**

This key represents in instance of the DsOfdmChannelCfg of the Downstream OFDM channel.

**7.3.7.2.2 DsOfdmProfileCfgProfileId**

This key is the targeted profile being tested with OPT for the instance of DsOfdmChannelCfgIndex. For Data Profile testing, the ID of the profile that is being tested is used.

Reference [MULPIv3.1] OFDM Downstream Profile Test Response (OPT-RSP)

**7.3.7.2.3 ModulationOrder**

This key specifies the modulation types supported by the CCAP modulator. The value of zeroBitLoaded means that the subcarrier is BPSK modulated.

This attribute corresponds to the TLV 2.1 in the OPT-REQ.

Reference: [PHYv3.1], [MULPIv3.1] OPT-REQ TLV Encodings

**7.3.7.2.4 RxMerVsBitloadingTarget**

This attribute is the required value for the profile RxMER (refer to OPT-RSP) in units of 0.25dB (0xFF is 63.75dB). This is the required RxMER value that the CM uses to calculate the SNR margin for the profile. The default values for this attribute are defined in [PHYv3.1] CM Minimum CNR Performance in AWGN Channel.

This attribute corresponds to the TLV 2.2 in the OPT-REQ.

Reference: [PHYv3.1] CM Error Ratio Performance in AWGN Channel, [MULPIv3.1] OPT-REQ TLV Encodings

### 7.3.7.2.5 RxMerMargin

The CM reports the number of subcarriers with a measured RxMER value that is at least this value below the target RxMER for the bitloading of the given subcarrier in the OPT-RSP message.

This attribute corresponds to the TLV 2.3 in the OPT-REQ.

Reference: [MULPIv3.1] OPT-REQ TLV Encodings

### 7.3.7.3 OptResp Object

One of the main issues for the modeling for OPT-RSP is that all OPT responses will not be alike. Some tests will only require one test or maybe a combination of one or more tests. As a result, the information model and resulting data models need to be able to gather the needed data for each CM and provide that to the PMA. Details of this operation can be found in [MULPIv3.1] OFDM Downstream Profile Test Response (OPT-RSP).

MER data from the CM will be recorded as a series of hex values (0x00 to 0xFF) that will represent the MER values that the CM has measured. These values are gathered from the first active subcarrier to the last active subcarrier in the OFDM channel definition. The data from the CM will not contain pairs of values (subcarrierId and MER value) but just the subcarrier MER value. For the PMA to make sense of the data, the CCAP must provide the first active subcarrier to allow the PMA to know where it should start associating the values from the CM to the individual subcarriers defined in the channel. This information will need to be learned by the PMA from the DsOfdmChannelStatus object (DsOfdmChannelStatus, FirstActiveSubcarrierNum).

**Table 7-121 - OptResp Attributes**

Attribute Name	Type	Access	Type Constraints	Units	Default Value
CmMac	MacAddress	Key			
DsOfdmChannelCfgIndex	UnsignedByte	Key			
DsOfdmProfileCfgProfileId	UnsignedByte	Key	0..16   255		
Status	OptRespStatusType	R/O	testing(1) profileAlreadyUnderTest(2) unavailableResources(3) maxDurationExpired(4) aborted(5) complete(6) profileAlreadyAssigned(7)		
FirstActiveSubcarrierNum	UnsignedInt	R/O	148..7895		
MerData	RxMerData	R/O	SIZE (0..7680)		
MerPassFailData	HexBinary	R/O	SIZE (0..7680)		
NumSubcarriersBelowThreshold	UnsignedInt	R/O			
SnrMarginData	QuarterDb	R/O		dB	
CodewordCount	Counter64	R/O		Number of codewords	
CorrectedCodewordCount	Counter64	R/O		Number of codewords	
UncorrectableCodewordCount	Counter64	R/O		Number of codewords	
NcpFieldCount	Counter64	R/O			
NcpCrcFailCount	Counter64	R/O			

#### 7.3.7.3.1 CmMac

This key represents the MAC address for the referenced CM.

#### 7.3.7.3.2 DsOfdmChannelCfgIndex

This attribute represents in instance of the DsOfdmChannelCfg of the Downstream OFDM channel that is currently assigned to a CM. This attribute is a key for this object.

### 7.3.7.3.3 *DsOfdmProfileCfgProfileId*

This attribute is the targeted profile being tested with OPT for the instance of DsOfdmChannelindex. This attribute is a key for this object.

### 7.3.7.3.4 *Status*

This attribute allows the CCAP to return the status of a specific OPT test request. The value of this attribute is found in the status portion of the OPT-RSP header that is returned from the CM when the OPT-REQ is received by the CM. The values include:

testing(1) – The CM has initiated the requested tests.

profileAlreadyUnderTest(2) – The CM received a request, but the profileId requested was already being used for an active test.

unavailableResources(3) – The CM had an error with the request related to available resources to run the test collection.

maxDurationExpired(4) – The CM has reported that for this test, the maximum duration value has expired.

aborted(5) – The CM received an OPT-REQ request with an OpCode of abort and is aborting the tests requested.

complete(6) – The CM has successfully completed the requested testing.

profileAlreadyAssigned(7) – The CM is reporting that the referenced profileId is already assigned and may not be used for the requested tests.

Reference: [MULPIv3.1] OFDM Downstream Profile Test Response (OPT-RSP)

### 7.3.7.3.5 *FirstActiveSubcarrierNum*

This attribute is the subcarrier index of the lowest subcarrier in the Occupied Bandwidth of the channel.

### 7.3.7.3.6 *MerData*

This attribute contains the MER data for the active subcarriers in the instance of the DsOfdmChannel. The data represents Integer modulation error ratio measurements in 0.25 dB steps (0x00-0xFE represents 0-63.5 dB; 0xFF indicates no measurement available). These are encoded as a packed sequence of 8-bit values for N consecutive subcarriers ( $N \leq 7680$ ) from lowest active subcarrier to the highest active subcarrier, including all the subcarriers in between. This attribute is a variable length and is dependent on the channel width and the number of active subcarriers that are available. This attribute is a channel level measurement and is independent of the profile being tested.

Reference: [MULPIv3.1] OPT-RSP TLV Encodings

### 7.3.7.3.7 *MerPassFailData*

This attribute contains a Pass/Fail indication for each subcarrier's RxMER (1 bit for each subcarrier). A value of 1 indicates that the measured MER  $\geq$  target value in the OPT-REQ. A value of 0 indicates that the measured MER  $<$  target value in the OPT-REQ. These are encoded as a sequence of 1-bit values for N consecutive subcarriers ( $N \leq 7680$ ) from lowest active subcarrier.

Reference: [MULPIv3.1] OPT-RSP TLV Encodings

### 7.3.7.3.8 *NumSubcarriersBelowThreshold*

This attribute indicates the number of subcarriers ( $\leq 7680$ ) whose RxMER is  $\geq$  the RxMER Margin below the RxMER target for the bitloading of the given subcarrier.

Reference: [MULPIv3.1] OPT-RSP TLV Encodings

### 7.3.7.3.9 *SnrMarginData*

This attribute indicates the SNR margin of the candidate data profile (signed integer), in units of 0.25dB, calculation is as defined in [PHYv3.1].

Reference: [MULPIv3.1] OPT-RSP TLV Encodings

#### 7.3.7.3.10 *CodewordCount*

This attribute is a count of the measured number of codewords that the CM has successfully received during the testing interval for the profile being tested - unsigned integer count of codewords that were examined during testing. If Codeword Tagging is disabled, this count includes all codewords received on the profile in question for the duration of the test. If Codeword Tagging is enabled, this count includes only codewords received on the profile in question for the duration of the test for which the 'T' bit was set in the NCP pointing to the codeword. The location of the 'T' bit is specified in [PHYv3.1].

Reference: [MULPIv3.1] OPT-RSP TLV Encodings

#### 7.3.7.3.11 *CorrectedCodewordCount*

This attribute is a count of the measured number of codewords that the CM has successfully received and was able to correct during the testing interval for the profile being tested - unsigned integer count of codewords that were examined during testing. If Codeword Tagging is disabled, this count includes all codewords received on the profile in question for the duration of the test. If Codeword Tagging is enabled, this count includes only codewords received on the profile in question for the duration of the test for which the 'T' bit was set in the NCP pointing to the codeword. The location of the 'T' bit is specified in [PHYv3.1].

#### 7.3.7.3.12 *UncorrectableCodewordCount*

This attribute is a count of the measured number of uncorrectable codewords that the CM has received during the testing interval for the profile being tested - unsigned integer count of codewords that failed pre-decoding LDPC syndrome check and passed BCH decoding. If Codeword Tagging is disabled, this count includes all codewords received on the profile in question for the duration of the test. If Codeword Tagging is enabled, this count includes only codewords received on the profile in question for the duration of the test for which the 'T' bit was set in the NCP pointing to the codeword. The location of the 'T' bit is specified in [PHYv3.1].

Reference: [MULPIv3.1] OPT-RSP TLV Encodings

#### 7.3.7.3.13 *NcpFieldCount*

This attribute records the number of NCP fields that were examined by the CM during the test interval.

Reference: [MULPIv3.1] OPT-RSP TLV Encodings

#### 7.3.7.3.14 *NcpCrcFailCount*

This attribute records the number of NCP fields that failed the NCP CRC check.

Reference: [MULPIv3.1] OPT-RSP TLV Encodings

### 7.3.7.4 **ProfileChangeCfg Object**

This object allows the Operator to force changes in the assigned profiles on a given registered CM. Attempts to change profiles on a CM that is not currently in an operational state MUST be rejected by the CCAP. If the CCAP receives a request to change a profile on the CM and the DsChannelId is not currently in use by the CM, the CCAP MUST reject the request. If the CCAP receives a request to change a profile on the CM and one or more profiles referenced in the DsProfileList do not exist, the CCAP MUST reject the request.

This object supports the creation and deletion of multiple instances.

**Table 7-122 - ProfileChangeCfg Attributes**

Attribute Name	Type	Required Attribute	Type Constraints	Units	Default Value
CmMac	MacAddress	Key			
IfIndex	InterfaceIndex	Key			
DsProfileList	HexBinary	R/W	SIZE (1..4)		

#### 7.3.7.4.1 *CmMac*

This key represents the MAC address for the referenced CM.

#### 7.3.7.4.2 *IfIndex*

This attribute is the ifIndex of the DS OFDM channel for which the CMTS will instruct the CM to adjust its profiles.

#### 7.3.7.4.3 *DsProfileIdList*

This attribute is a list of N 1-byte downstream OFDM profile IDs assigned for the OFDM channel.

## 7.4 IPDR

The CCAP MUST implement IPDR/SP as described in Section 8.

The CCAP MUST support IPDR reporting on all of its access network interfaces (QAM, PON, etc.).

### 7.4.1 IPDR Service Definitions

The CCAP MUST support all IPDR service definitions defined as mandatory in Section 8, including SAMIS. Refer to DOCSIS IPDR Service Definitions figure in Section 8 for the IPDR service definition object diagram.

If the CCAP supports PON interfaces, the CCAP MUST support all IPDR service definitions defined as mandatory in [DPoE OSSv2.0].

## 8 ACCOUNTING MANAGEMENT<sup>210</sup>

### 8.1 SAMIS

This specification defines an accounting management interface for subscriber usage-based applications denominated Subscriber Account Management Interface Specification (SAMIS). SAMIS is defined to enable prospective vendors of cable modems and cable modem termination systems to address the operational requirements of subscriber account management in a uniform and consistent manner. It is the intention that this would enable operators and other interested parties to define, design and develop Operations and Business Support Systems necessary for the commercial deployment of different class of services over cable networks, with accompanying usage-based billing of services for each individual subscriber.

Subscriber Account Management described here refers to the following business processes and terms:

Class of Service Provisioning Processes, which are involved in the automatic and dynamic provisioning and enforcement of subscribed class of policy-based service level agreements (SLAs).

Usage-Based Billing Processes, which are involved in the processing of bills based on services rendered to and consumed by paying subscribers. This Specification focuses primarily on bandwidth-centric usage-based billing scenarios. It complements the PacketCable Event Messages Specification [PKT EM].

The business processes defined above are aligned with the scenarios for Subscriber Account Management described in Appendix I of [OSSiv3.0]. In order to develop the DOCSIS-OSS Subscriber Account Management Specification, it is necessary to consider high-level business processes common to cable operators and the associated operational scenarios. These issues are discussed in Annex B.

The CCAP MUST support collection of usage information, for use by the billing system, via an interface known as the Subscriber Accounting Management Interface Specification (SAMIS).

#### 8.1.1 Subscriber Usage Billing and class of services<sup>211</sup>

The [MULPIv3.1] specification uses the concept of class of service, as the term to indicate the type of data services a CM requests and receives from the CCAP. From a high level perspective class of services are observed as subscriber types (e.g., residential or business) and the DOCSIS RFI MAC layer parameters fulfill the subscriber service needs.

The [MULPIv3.1] specification supports a DOCSIS 1.1 QoS service class definition type that offers queuing and scheduling services. The DOCSIS 1.0 Class of Service (CoS) service class definition type has been deprecated and is not supported in DOCSIS 3.1.

##### 8.1.1.1 DOCSIS 1.1 Quality of Service (QoS)

The [MULPIv3.1] specification provides a mechanism for a CM to register with its CCAP and to configure itself based on external QoS parameters when it is powered up or reset.

To quote (in part) from the Theory of Operation section of [MULPIv3.1]:

*The principal mechanism for providing enhanced QoS is to classify packets traversing the RF MAC interface into a Service Flow. A Service Flow is a unidirectional flow of packets that provide a particular Quality of Service. The CM and the CMTS provide this QoS by shaping, policing, and prioritizing traffic according to the QoS Parameter Set defined for the Service Flow.*

The requirements for Quality of Service include:

- A configuration and registration function for pre-configuring CM-based QoS Service Flows and traffic parameters.

<sup>210</sup> CMTS changed to CCAP in many instances per CCAP-OSSiv3.1-N-15.1307-3 on 6/1/15 by KB.

<sup>211</sup> Modified per CCAP-OSSiv3.1-N-16.1618-3 on 11/17/16 by KB.

- Utilization of QoS traffic parameters for downstream Service Flows.
- Classification of packets arriving from the upper layer service interface to a specific active Service Flow
- Grouping of Service Flow properties into named Service Classes, so upper layer entities and external applications (at both the CM and the CCAP) can request Service Flows with desired QoS parameters in a globally consistent way.

A Service Class Name (SCN) is defined in the CCAP by provisioning (see [OSSv3.0] Annex O). An SCN provides an association to a QoS Parameter Set. Service Flows that are created using an SCN are considered to be "named" Service Flows. The SCN identifies the service characteristics of a Service Flow to external systems such as a billing system or customer service system. For consistency in billing, operators should ensure that SCNs are unique within an area serviced by the same BSS that utilizes this interface. A descriptive SCN might be something like PrimaryUp, GoldUp, VoiceDn, or BronzeDn to indicate the nature and direction of the Service Flow to the external system.

A Service Package implements a Service Level Agreement (SLA) between the MSO and its Subscribers on the RFI interface. A Service Package might be known by a name such as Gold, Silver, or Bronze. A Service Package is itself implemented by the set of named Service Flows (using SCNs) that are placed into a CM Configuration File<sup>212</sup> that is stored on a Config File server. The set of Service Flows defined in the CM Config File are used to create active Service Flows when the CM registers with the CCAP. Note that many Subscribers are assigned to the same Service Package and, therefore, many CMs use the same CM Config File to establish their active Service Flows.

A Service Package has to define at least two Service Flows known as Primary Service Flows that are used by default when a packet matches none of the classifiers for the other Service Flows. A CM Config File that implements a Service Package, therefore, needs to define the two primary Service Flows using SCNs (e.g., PrimaryUp and PrimaryDn) that are known to the CCAP if these Service Flows are to be visible to external systems by this billing interface. Note that it is often the practice in a usage sensitive billing environment to segregate the operator's own maintenance traffic, to and from the CM, into the primary service flows so that this traffic is not reflected in the traffic counters associated the subscriber's SLA service flows.

The [MULPIv3.1] specification also provides for dynamically created Service Flows. An example could be a set of dynamic Service Flows created by an embedded PacketCable Multimedia Terminal Adapter (eMTA) to manage VoIP signaling and media flows. All dynamic Service Flows need to be created using an SCN known to the CCAP if they are to be visible to the billing system. These dynamic SCNs do not need to appear in the CM Config File but the MTA may refer to them directly during its own initialization and operation.

During initialization, a CM communicates with a DHCP Server that provides the CM with its assigned IP address and, in addition, receives a pointer to the Config File server that stores the assigned CM Config File for that CM. The CM reads the CM Config File and forwards the set of Service Flow definitions (using SCNs) up to the CCAP. The CCAP then performs a macro-expansion on the SCNs (using its provisioned SCN templates) into QoS Parameter Sets sent in the Registration Response for the CM. Internally, each active Service Flow is identified by a 32-bit SFID assigned by the CCAP to a specific CM (relative to the RFI interface). For billing purposes, however, the SFID is not sufficient as the only identifier of a Service Flow because the billing system cannot distinguish the class of service being delivered by one SFID from another. Therefore, the SCN is necessary, in addition to the SFID, to identify the Service Flow's class of service characteristics to the billing system.

The billing system can then rate the charges differently for each of the Service Flow traffic counts based on its Service Class (e.g., Gold octet counts are likely to be charged more than Bronze octet counts). Thus, the billing system obtains, from the CCAP, the traffic counts for each named Service Flow (identified by SFID and SCN) that a subscriber's CM uses during the billing data collection interval. This is true even if multiple active Service Flows (i.e., SFIDs) are created using the same SCN for a given CM over time. This will result in multiple billing records for the CM for Service Flows that have the same SCN (but different SFIDs). Note that the SFID is the primary key to the Service Flow. When an active Service Flow exists across multiple sequential billing files, the SFID allows the sequence of recorded counter values to be correlated to the same Service Flow instance.

---

<sup>212</sup> The CM Configuration File contains several kinds of information needed to properly configure the CM and its relationship with the CMTS, but for the sake of this discussion only the Service Flow and Quality of Service components are of interest



### **8.1.1.2 High-Level Requirements for Subscriber Usage Billing Records**

This section provides the high-level, functional requirements of the Subscriber Usage Billing interface.

The CCAP provides formatted Subscriber Usage Billing Records for all subscribers attached to the CCAP, on demand, to mediation or billing systems.

The transfer of these Usage Billing Records from the CCAP to the mediation/billing system uses the streaming model defined in [IPDR/SP]. This is a mechanism for transmission of Usage Billing Records in near "real-time" from the CCAP to the mediation system.

The CCAP needs to support a minimum billing record transfer interval of 15 minutes.

The CCAP MUST support the processing and transmitting of Subscriber Usage Billing Records as follows:

- A Subscriber Usage Billing Record identifies the CCAP by host name and IP address and the date and time record is sent. The sysUpTime value for the CCAP is recorded, as well as the MAC domain, downstream and upstream information, the CM is registered on to facilitate the characterization of cable interfaces usage.
- A Subscriber Usage Billing Record is identified by CM MAC address (but not necessarily sorted). The Subscriber's current CM IP address is also present in the billing record for the Subscriber. If the CCAP is tracking CPE addresses behind the Subscriber's CM, then these CPE MAC and IP addresses are also present in the billing record as well. CPE FQDNs (Fully Qualified Domain Name) are present in the billing record only if gleaned from DHCP relay agent transactions (reverse DNS queries are not required).
- A Subscriber Usage Billing Record has entries for each active Service Flow (identified by SFID and Service Class Name) used by all CMs operating in DOCSIS 1.1 (or higher) registration mode during the collection interval. This includes all currently running Service Flows, as well as all terminated Service Flows that were deleted and logged during the collection interval. A provisioned or admitted state SF that was deleted before it became active, is not recorded in the billing document, even though it was logged by the CCAP.
- A Subscriber Usage Billing Record identifies a running Service Flows or a terminated Service Flow, as well as a de-registered CM. A terminated Service Flow is reported into a Subscriber Usage Billing Record once.
- A Subscriber Usage Billing Record identifies the Service Flow direction as upstream or downstream. It collects the number of packets and octets passed for each upstream and downstream Service Flow. The number of packets dropped and the number of packets delayed due to enforcement of QoS maximum throughput parameters (SLA) are also collected for each Service Flow. In the case of an upstream Service Flow, the reported SLA drop and delay counters represent only the QoS policing performed by the CCAP. Note that since it is possible for a Subscriber to switch back and forth from one service package to another, or to have dynamic service flows occur multiple times, it is possible that there will be multiple Subscriber Usage Records for a given SCN during the collection period. This could also occur if a CM re-registers for any reason (such as CM power failure).
- All traffic counters within a Subscriber Usage Billing Record are absolute 32-bit or 64-bit counters. These traffic counters need to be reset to zero by the CCAP if it re-initializes its management interface. The CCAP sysUpTime value is used to determine if the management interface has been reset between adjacent collection intervals. It is expected that the 64-bit counters will not roll over within the service lifetime of the CCAP.

### **8.1.1.3 Subscriber Usage Billing Records Mapping to Existing DOCSIS Data model**

In Section 8.1.1.2 the High-level requirements for Subscriber Usage Billing includes counters for consumption-based billing. Part of that section deals with the collection of counters associated with DOCSIS 1.1 Quality of Service. The mapping described below is required to consistently define the Subscriber Usage Billing service specification based on mandatory and well-defined counter requirements as much as possible.

The [MULPIv3.1] specification does not define MAC layer primitives for usage counters associated to SFIDs to be mapped to Management models like SNMP or this Subscriber Usage Billing service specification.

DOCSIS mandatory QoS counter requirements are contained in this specification. They are defined as UML Information models in Section 7.2 of this specification; see Section 7.1 for details on the corresponding SNMP SMI data models.

Table 8-1 describes the Subscriber Usage Billing model mapping to this specification standard management object base and other requirements not defined in this specification. See Table Notes immediately following Table 8-1.

**Table 8-1 - Subscriber Usage Billing Model Mapping to DOCSIS Management Object**

Subscriber Usage Billing Service Definition Elements		DOCS-QOS3-MIB DOCSIS QoS model Unicast and Multicast SFs
Elements	Type	OBJECT-TYPE Record Interim, Stop
serviceIdentifier	UnsignedInt	docsQosServiceFlowId <sup>1</sup>
serviceGateId	UnsignedInt	N/A <sup>2</sup>
serviceName	String	docsQosParamSetServiceClassName <sup>1</sup> , docsQosServiceFlowLogServiceClassName
serviceDirection	UnsignedInt	docsQosServiceFlowDirection, docsQosServiceFlowLogDirection
serviceOctetPassed	UnsignedLong	docsQosServiceFlowOctets, docsQosServiceFlowLogOctets
servicePktsPassed	UnsignedLong	docsQosServiceFlowPkts, docsQosServiceFlowLogPkts
serviceSlaDropPkts	UnsignedInt	docsQosServiceFlowPolicedDropPkts, docsQosServiceFlowLogPolicedDropPkts
serviceSlaDelayPkts	UnsignedInt	docsQosServiceFlowPolicedDelayPkts, docsQosServiceFlowLogPolicedDelayPkts
serviceTimeCreated	UnsignedInt	docsQosServiceFlowTimeCreated, docsQosServiceFlowLogTimeCreated
serviceTimeActive	UnsignedInt	docsQosServiceFlowTimeActive, docsQosServiceFlowLogTimeActive
<b>Table Notes:</b>		
1 serviceIdentifier: for interim records applicable only to 'active' Service Flows		
2 serviceGateId is not part of the DOCSIS QoS model but is available from [PCMM]		

These elements are defined in Annex C.

Reporting on Multicast flows based upon DS Multicast does not provide sufficient information for Accounting purposes. The current definition for Multicast flow reporting is for the purposes of Capacity Management. Multicast reporting for Accounting purposes is a subject of future extensibility.

The model above is intended to de-couple the internal management primitives of the required MIB objects as an indication that both processes might be updated independently, or as direct relationships of existing management objects. Therefore, in the case of an active Subscriber Usage Billing IPDR/SP Session, the CCAP SHOULD NOT allow the deletion of Service Flow log records until they have been exported by [IPDR/SP].

#### **8.1.1.4 SAMIS Records Optimization**

The CMTS MAY provide mechanisms to prevent exporting Subscriber Usage Billing Records (record suppression) that contain redundant information from a Collector perspective. If traffic counters (octets or packets) of a SFID reported in a previous collection interval do not change, the CMTS does not generate a record for this SFID for this collection interval. The serviceTimeActive counter is not considered a traffic counter and therefore does not influence record suppression.

#### **8.1.1.5 Billing Collection Interval Subscriber Usage Billing Records Export**

In the case of streaming data at the end of a collection interval, the CCAP (Exporter) MUST create a new IPDR document by starting, and stopping an IPDR/SP Session every collection period. Note that between scheduled collection cycles, the CCAP and the Collector(s) maintain an open TCP stream Connection and the Collector is also in a flow ready state. The CCAP MUST initiate a new Session when it is ready to transmit a complete set of IPDR records to the Collector for the current collection interval. Once the complete set of IPDR records has been transmitted, the CCAP MUST stop the session immediately or stop the session at the end of the collection interval, thereby closing the IPDR document for the current collection interval. When the session is stopped immediately, all subsequent terminated SF's MUST be buffered by the Exporter until they can be transmitted in the next scheduled collection interval. The CCAP MAY also leave the session open until the next collection interval. In addition to the scheduled collection cycles, the CCAP MAY also initiate an unscheduled Session with a Collector whenever it needs to transmit IPDR records for terminated SFs because it is in danger of losing data (e.g., its SF log buffer is about to overflow). This unscheduled Session will only contain RecType = Stop IPDR records for the terminated SFs in the log buffer, thereby clearing the buffer. It is imperative that logged SFs are only reported once into an IPDR document. If no connection is available (e.g., for an unscheduled Session or existing open Session) with a Collector, then the CCAP MUST delete the oldest SF log entries first.

Other Management strategies may provide Collector control over the streaming data by executing FlowStop and FlowStart at its convenience (for example to perform load balancing or force the termination of streaming from an Exporter).

### **8.1.2 DOCSIS Subscriber Usage Billing Requirements**

The CCAP MUST support Subscriber Usage Billing by implementing this Subscriber Accounting Management Interface Specification (SAMIS) based on [IPDR/BSR].

## **8.2 IPDR Protocol**

### **8.2.1 Introduction**

This section defines the IPDR Streaming Protocol [IPDR/SP] requirements for the CCAP. Unless otherwise indicated, the term "IPDR Exporter" refers to the CCAP. A collector system is often referred to as an "IPDR Collector" and conforms to [IPDR/BSR] and in particular to [IPDR/SP] specification. IPDR collector management requirements are outside the scope of this specification. See Section 8.2.2 for a brief overview of the IPDR Standard.

[IPDR/SP] provides scalable solutions for the collection of high volume management data related to performance, usage, and operational status of the cable networks. The [IPDR/SP] scalability benefits are for both the CCAP and the data collection systems. The CCAP gains in reduced computing resources, compared with other management protocols, such as SNMP, when generating comparable data sets. The collector systems benefit from [IPDR/SP] by reducing the costs associated with reliable data collection, scalable growth in number of records, and multiple types of data sets over the same collection platform. See [IPDR/SP] for additional information about the streaming protocol design considerations.

The IPDR-related standards listed in Table 8-2 are supported by CCAP.

**Table 8-2 - IPDR-related Standards**

[IPDR/SP]	IPDR/SP Protocol Specification
[IPDR/BSR]	IPDR Business Solution Requirements - Network Data Management Usage (NDM-U)
[IPDR/SSDG]	IPDR Service Specification Design Guide
[IPDR/XDR]	IPDR/XDR Encoding Format
[IPDR/CAPAB]	IPDR/Capability File Format

**8.2.2 IP Detail Record (IPDR) Standard**

[IPDR/SSDG] defines a generic model for using XML Schema in IP Detail Recording applications. [IPDR/XDR] defines the compact binary representation of corresponding IP Detail Records. The following subsections describe the IPDR standard and its application in DOCSIS networks.

**8.2.2.1 IPDR Network Model**

The IPDR Network Model is given in the [IPDR/BSR] specification and is portrayed in Figure 8-1. In this network model, the Service Consumer (SC) is the Cable Data Service Subscriber identified by their Cable Modem MAC address, current CM IP address, and current CPE IP addresses. The Service Element (SE) is the CCAP identified by its host name, IP address, and current value of its sysUpTime object. The IPDR Recorder (IR) is the record formatter and exporter function that creates the data record compliant to [IPDR/BSR] based on the DOCSIS schemas. The IPDR Store (IS) and the IPDR Transmitter (IT) are two kinds of collector functions that receive IPDR XDR records from the IR exporter function as specified in Section 8.2.3. The CCAP implements the IPDR Recorder (IR) functions and is often referred to as the "Exporter". The IT/IS collector functions receive IDPR XDR records on a collection cycle determined by the IR exporter function.

The A-interface is not specified by the [IPDR/BSR] specification because it is an internal interface between the SE and the IR exporter components. The B-interface between the IR exporter and the IT/IS collector components is specified by the IPDR Streaming Protocol [IPDR/SP]. The CCAP supports the B-interface.

**NOTE:** The highlighted blocks and interfaces depicted in Figure 8-1 are the only ones defined in this specification. The A, C, D, E, and F interfaces are beyond the scope of this specification.

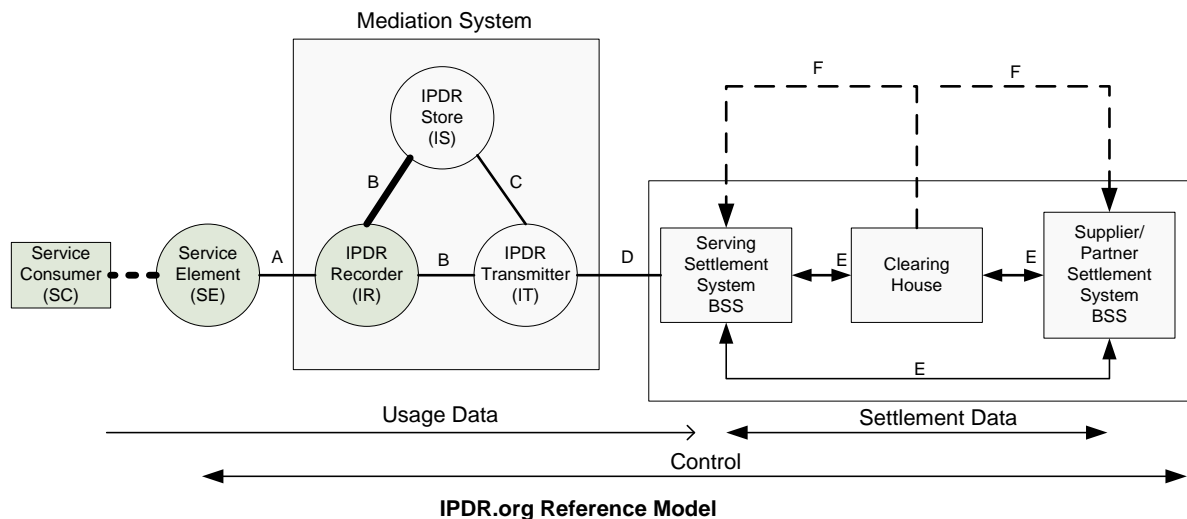

**Figure 8-1 - Basic Network Model (ref. [IPDR/BSR])**

### 8.2.2.2 IPDR Transport High Level Protocol Requirements

To facilitate processing of the DOCSIS IPDR Service Definitions by a large number of mediation systems, an Extensible Markup Language (XML) [W3 XML1.0] format is required. Specifically, the IP Detail Record (IPDR) standard as described in [IPDR/BSR] is used to model the DOCSIS IPDR Service Definitions.

To improve the performance of storage and transmission of the BSR XML records, a compression mechanism is required. [IPDR/XDR] describes a compact encoding of IPDR Docs, based on the IETF XDR specification language [RFC 1832].

To improve the network performance of the data collection activity, a reliable high-throughput TCP stream is used to transfer data records between the record formatter and the collection system. Furthermore, at the application layer the streaming protocol [IPDR/SP] described in Section 8.2.3 is implemented to scale the collection of data in a reliable manner for both Exporters and Collectors.

To ensure the end-to-end privacy and integrity of the billing records, while either stored or in transit, an authentication and encryption mechanism between the record formatter and the collection system is desirable. The security model is detailed in Section 8.2.7.

### 8.2.2.3 IPDR Record Structure

The Master IPDR Schema Document (IPDRDoc) [IPDR/BSR] defines the generic structure of any IPDR document regardless of application. The IPDRDoc defines the hierarchy of elements within an IPDR instance document that are supported by the CCAP as shown in Figure 8-2 below.

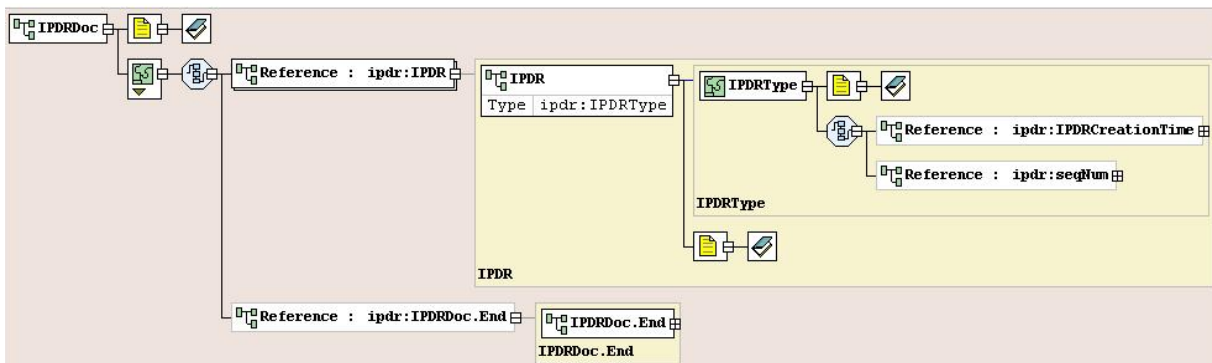

Figure 8-2 - IPDRDoc 3.5.1 Master Schema

### 8.2.2.4 Service Definition Schemas

Service definition schemas are defined based on the guidelines listed in [IPDR/SSDG]. Refer to the applicable Annex as defined in Table 8-6 for each service definition schema.

### 8.2.2.5 Service Definition Instance Documents

To complete the definition of an application-specific IPDR record structure, an application instance schema needs to be provided that imports the basic IPDRDoc master schema (see [IPDR/SSDG]). The IPDRDoc records may be constructed by the Collector for the purpose of storing. The Collector takes the data records and may use the session ID to construct a docId, it depends upon the collector storing IPDR records as IPDR documents, or simulating a docId for the purpose of acknowledging each record as part of a reliable collection process labeled with a docId (accounting of total number of records). Some ways to demark docId could be session start/stop boundaries, but it is Collector implementation specific.

1. The IPDRDoc element is the outermost element that describes the IPDR file itself. It defines the XML namespace, the identity of the XML schema document, the version of the specification, the timestamp for the

file, a unique document identifier, and the identity of the IPDR recorder. An IPDRDoc is composed of multiple IPDR records.

The attributes for the IPDRDoc element are defined as follows:

a) `xmlns:ipdr="http://www.ipdr.org/namespaces/ipdr"`

Constant: the IPDR XML namespace identifier.

b) `xmlns:xsi="http://www.w3.org/2001/XMLSchema-instance"`

Constant: the XML Schema Instance Namespace identifier. Defined by the W3C Consortium.

c) `xmlns="http://www.cablelabs.com/namespaces/DOCSIS/3.0/xsd/ipdr"`

Constant: the DOCSIS XML namespace identifier. Defined by CableLabs.

d) `xsi:schemaLocation="*.xsd"`

Constant: the name of the DOCSIS service definition schema file. Refer to Table 8-6 for a list of the DOCSIS service definition schema files.

e) `version="<IPDR BSR version>-<DOCSIS IPDR version>.<schema version>"213`

Constant: the version of the IPDR document. Defined by Cable Television Laboratories, Inc. This specification follows the convention of `<IPDR BSR version>-<DOCSIS IPDR version>.<schema version>`. `<IPDR BSR version>` is currently 3.5.1 (refer to [IPDR/BSR]). `<DOCSIS IPDR version>` is "A" for DOCSIS 3.0 and "B" for DOCSIS 3.1. `<Schema version>` is the version number of the corresponding service definition schema. For example, the first version of a DOCSIS Service Definition schema in compliance with version 3.5.1 of [IPDR/BSR] and DOCSIS 3.1 is defined as "3.5.1-B.1" and the third version of a DOCSIS 3.0 schema is defined as "3.5.1-A.3".

f) `creationTime="yyyy-mm-ddThh:mm:ssZ"`

UTC time stamp at the time the IPDR Record is created (in ISO format). For example: `creationTime="2002-06-12T21:11:21Z"`. Note that IPDR timestamps are always specified in UTC/GMT (Z). The compact representation of this element is the 32-bit unsignedLong value since EPOCH [IPDR/XDR].

g) `docId="<32-bit UTC timestamp>-0000-0000-0000-<48-bit MAC address>"`

The unique document identifier. The DOCSIS docId is in a simplified format that is compatible with the Universally Unique Identifier (UUID) format required by the IPDR [IPDR/BSR] specification.

- The docId attribute consists of the following:
- The 32-bit UTC timestamp contains the IPDRDoc creationTime in seconds since the epoch 1 Jan 1970 UTC formatted as eight hex digits.
- The 48-bit MAC address component is the Ethernet address of the CCAP management interface formatted as 12 hex digits.
- All other components are set to zero.

In the context of the minimum 15-minute IPDR billing file collection cycle specified in this document, this simplified UUID is guaranteed to be unique across all CCAPs and for the foreseeable future.

h) `IPDRRecorderInfo="hostname.mso.com"`

IPDRRecorderInfo identifies the IPDR Recorder (IR) from the network model in Figure 8-1. Since the CCAP includes the IPDR Recorder function, the CCAP MUST populate the IPDRRecorderInfo attribute with its fully qualified hostname. If a hostname is not available, then the CCAP MUST populate the IPDRRecorderInfo attribute with its IPv4 address formatted in dotted decimal notation.

<sup>213</sup> Modified per CCAP-OSSIV3.1-N-15.1390-2 on 11/11/15 by KB.

2. An IPDR element describes a single DOCSIS service application specific record. The IPDR record is further structured into DOCSIS specific sub elements that describe the details of the CCAP, the subscriber (CM and CPE), and the service application itself. The attributes for the IPDR element are:

xsi:type="\*-TYPE"

Constant: identifies the DOCSIS application specific type of the IPDR record. Examples of types based on the DOCSIS Service Definitions listed in Table 8-6.

In addition to the DOCSIS service specific sub-elements, the following sub-elements for the IPDR element are:

- a) IPDRCreationTime

The IPDRCreationTime element identifies the time associated with the counters for this record. The IPDRCreationTime element uses the same format as the IPDRDoc creationTime attribute (see 1f. above). The CCAP MUST NOT support IPDRCreationTime element.

**NOTE:** This sub element is optional in the basic IPDR 3.5.1 schema, and is required by previous DOCSIS specifications. This specification deprecates that requirement and prohibits usage of IPDRCreationTime.

- a) seqNum

The CCAP MUST NOT support seqNum elements of the basic IPDR 3.5.1 schema.

**NOTE:** There is no ordering implied in DOCSIS IPDRs within an IPDRDoc.

3. IPDRDoc.End is the last element inside IPDRDoc. It defines the count of IPDRs that are contained in the file and the ending timestamp for the file creation. The attributes of IPDRDoc.End are:

- a) count="nnnn"

Where "nnnn" is the decimal count of the number of IPDR records in this IPDRDoc.

- b) endTime="yyyy-mm-ddThh:mm:ssZ"

Where endTime is the UTC time stamp at the time the file is completed (see 1f. above).

For [IPDR/SP] protocol, it is left to the collector to generate IPDRDoc.End based on SessionStop message for a specific docId, see Section 8.2.4. In addition, IPDRDoc.End is an [IPDR/BSR] optional field and it is included in this section for information purposes with no requirements for CCAPS Exporter.

### 8.2.3 IPDR Streaming Model

DOCSIS IPDR Service records are built by the record formatter on the CCAP and are then transmitted to the collection system using the IPDR Streaming Protocol [IPDR/SP].

The [IPDR/SP] Protocol is an application running over a reliable, connection oriented transport layer protocol such as TCP. It allows exporting high volume of Data Records from a Service Element with an efficient use of network, storage, and processing resources. There are also bi-directional control message exchanges, though they only comprise a small portion of the traffic.

The [IPDR/SP] was built upon two existing specifications, namely IPDR's [IPDR/BSR] [IPDR/XDR] file format and Common Reliable Accounting for Network Elements (CRANE) [RFC 3423].

It enables efficient and reliable delivery of any data, mainly Data Records from Service Elements (the record formatters that are denoted as the "Exporters") to any collection systems (that are denoted as the "Collectors"), such as mediation systems and BSS/OSS.

**NOTE:** The term "Exporter" corresponds to the CCAP, unless otherwise specified.

Since the IPDR Streaming Protocol could run over different transport layers in future versions, a transport neutral version negotiation is needed. [IPDR/SP] supports a negotiation mechanism running over UDP. Either the Exporter or the Collector could inquire about the Streaming Protocol version and transport layer support by sending a UDP packet on a configured UDP port.

### 8.2.3.1 Sessions and Collector Priorities

A Session is a logical connection between an Exporter and one or more Collectors for the purpose of delivering Data Records. For any given Session, a single active Collector will be targeted with those Data Records. Multiple Sessions may be maintained concurrently in an Exporter or Collector, in which case they are distinguished by Session IDs. For a complete specification of the Sessions, see [IPDR/SP].

A Collector is assigned a Priority value. Data Records need to be delivered to the Collector with the highest Priority value (the primary Collector) within a Session. The Collector Priority reflects the Exporter's preference regarding which Collector will receive Data Records. The assignment of the Collector Priority needs to consider factors such as geographical distance, communication cost, and Collector loading, etc. It is also possible for several Collectors to have the same priority. In this case, the selection method is vendor-specific.

### 8.2.3.2 Documents and Collection Methodologies

The IPDR/SP Protocol provides for open-ended streaming of data records as they are created, or as an option, logical boundaries may also be placed between groups of data records as well. A logical range of data records is called a document. For more information on this topic see [IPDR/SP]. Even though [IPDR/SP] supports the IPDRDoc instance documents requirements, the IPDRDoc is handled by the collector and not by the exporter. The collector can, for example, create IPDRDoc based on sessions start/stop sequence sent by the exporter, or based on number of records received.

In this specification, an IPDR document is defined as a series of records that were generated during the interval an IPDR session lasted or during a time interval called collection interval. Each DOCSIS IPDR Service Definition has its own requirements in terms of how IPDR documents are generated. For example, [IPDR/SP] sessions are created on a schedule basis, an open-ended session or a per-request session. Below is a list of collection methodologies:

**Time Interval Session:** The exporter follows a schedule based session to stream data on a periodic time interval. The collector creates the IPDRDoc within those demarcation points. Note that the Time Interval Session is managed by the exporter as being delimited by session start/stop messages. A collector initiated flow operation is possible as well; the collector issues Flow Stop messages to stop the exporter streaming. Finally, it is possible to control the Time Interval Session at either end-points. A Time Interval Session may close immediately after the exporter streams the records or remain open until the end of the time interval in which case, the exporter stops the session and starts a new session for the next time interval.

**Event Based Session:** It consists of an open-ended session or a Time Interval Session. During the time the IPDR session is open the exporter can stream records at any time, thus the name "Event Based Session". In the case of an open-ended session, the collector could create documents based on size, number of records received, timestamps (to simulate Time Interval Sessions), or never creates an IPDRDoc.

**Ad-hoc Session:** Per request (from a Collector), the Exporter creates a session and closes it when either the data is streamed or a closing command is generated. Once Collector starts flow, CCAP Exporter SHOULD start session, stream data and stop session. The CCAP Exporter can optionally support additional management interface triggers for starting the session.

Some variations of the collection methodologies above include the possibility that an open-ended session demarcated by the collector as IPDR document by time where the records are received.

In cases where periodic records exporting applies (Time Interval Session), the DOCSIS IPDR Service Definition needs to specify the handling of records deleted in the exporter before the scheduled time for data streaming. That is accomplished either with an immediate record if exporter does not want to retain such record in memory, or wait until the next periodic interval to report that data. It is also required to distinguish between the record being a periodically exported record or a final record. This specification defines a periodic record as an "interim" record and a final record as a "stop" record.



### 8.2.3.3 Data Types and Message Format

[IPDR/SP] describes its message format using an augmented form of [RFC 1832], External Data Representation (XDR) [IPDR/XDR]. Two augmentations of XDR used by [IPDR/XDR] that enable a more concise and formal C style syntax for describing protocol message formats, are as follows:

- Support for indefinite length specification. This allows for stream based encoding of information without knowing or calculating the entire length of a message or document in advance. The value of -1 in a length field indicates that, based on Template information, a decoder be able to determine where a message completes.
- No 32-bit alignment padding. Beginning in IPDR 3.5.1, both [IPDR/XDR] and [IPDR/SP] remove the padding constraint specified by XDR. This allows for specification to the byte level of structures. This augmentation is described in [RFC 1832], "Areas for Future Enhancement".

For a complete specification of the [IPDR/SP] message format see the Message Format section of that specification.

The type IDs for the base types and the derived types used in the protocol, the data structure as well as the data representation are described in the Data Types section of [IPDR/SP] specification.

### 8.2.3.4 Templates and Service Definitions

The IPDR/SP Protocol utilizes the concept of Templates in order to eliminate the transmission of redundant information such as field identifiers and typing information on a per data record basis.

A Template is an ordered list of Field Identifiers. A Field Identifier is the specification of a Field in the Template. A Template references an IPDR Service Definition. It specifies a data item that a Service Element (e.g., CCAP) may export. Each Field specifies the Type of the Field. [IPDR/SP] specifies that Templates may be optionally negotiated upon setup of the communication between the Exporter and the Collector. This allows the Exporter to avoid sending Fields that the Collector is not interested in. Several Templates can be used concurrently (for different types of records). Fields contained in a Template could be enabled or disabled. An enabled Field implies that the outgoing data record will contain the data item specified by the key. A disabled Field implies that the outgoing record will omit the specified data item. The enabling/disabling mechanism further reduces bandwidth requirements; it could also reduce processing in Service Elements, as only needed data items are produced. For a complete specification of the IPDR streaming Templates, refer to the Templates section of [IPDR/SP].

The IPDR/SP Protocol incorporates IPDR/Service Definitions [IPDR/SSDG], based on XML-Schema, by reference.

A Template references an IPDR Service Definition document, where a more complete definition of the Template is included. IPDR Service Definitions describe in detail the properties of the various data records and their fields (see Service Specification Design Guide 3.5.1 [IPDR/SSDG].)

### 8.2.3.5 Flow Control and Data Reliability

Flow control mechanisms are employed to ensure that data is sent from an Exporter to a Collector only if it is ready to receive data. Four messages are employed to support flow control:

- FlowStart and FlowStop are sent by the Collector to indicate whether it is ready or not ready to receive data.
- SessionStart and SessionStop messages are sent by the Exporter to designate the associated Collector the active/inactive Collector and to provide information about the IPDR document being transmitted within the Session.

Flow control mechanisms are likewise used to indicate to the Collector whether the Exporter considers the Collector to be a primary or backup Collector. The Flow control also provides information on the data sequence numbers and document Id so that the Collectors can collectively guarantee that no Data Records are lost. For the complete specification of the IPDR flow control mechanism refer to the Flow Control section of [IPDR/SP].

To further reduce the likelihood of data loss IPDR/SP Messages are acknowledged after they have been processed and the record information has been placed in persistent storage. Refer to the Data Transfer section of [IPDR/SP].

### 8.2.3.5.1 DOCSIS IPDR/SP Flow Diagrams

Figure 8-3 illustrates the Streaming Protocol flow diagram based on the DOCSIS default Streaming Flow (the Time Interval based Session Streaming) set of requirements.

Figure 8-4 illustrates the Streaming Protocol flow for Event Based Session.

Figure 8-5 illustrates the Streaming Protocol flow for the ad-hoc Session. The Ad-hoc Streaming flow diagram shown is one of the types. The Time Interval based Session Streaming can also be treated as an Ad-hoc streaming flow. Neither these diagrams nor the explanations provided limit the ability of a Collector or Exporter (CCAP) to be fully compliant with the IPDR Streaming Protocol flow diagram [IPDR/SP]. Note that these figures model a DocId boundary (established by the IPDR Streaming Session Start/Stop messages) that is used to identify the records created during a collection interval (see Section 8.2.3.2). A single continuously open session/document will span a single collection interval and will be closed at the end of the interval. Figure 8-3 represents a complete IPDR session/document and assumes the model of periodic data streaming with interim and stop records. Each entity instance of the DOCSIS IPDR Service will include one or more Interim records and one Stop record when the entity in the DOCSIS IPDR service is deleted. If a Service entity instance is both created and deleted within the same collection interval, then only a single Stop record is exported.

Since the collection interval may be up to 24 hours long, it is likely that Keep-Alive messages will be sent periodically to indicate that the session/document is still open but there are no Stop records to export at the moment. Later, at the end of the collection interval, the current session/document is terminated with a SessionStop message, a new DocId is created, and the next session/document is started with a SessionStart message.

**NOTE:** The sequence diagram shown in Figure 8-3, Figure 8-4 and Figure 8-5 does not include optional Template Negotiation and the mandatory KeepAlive messages.

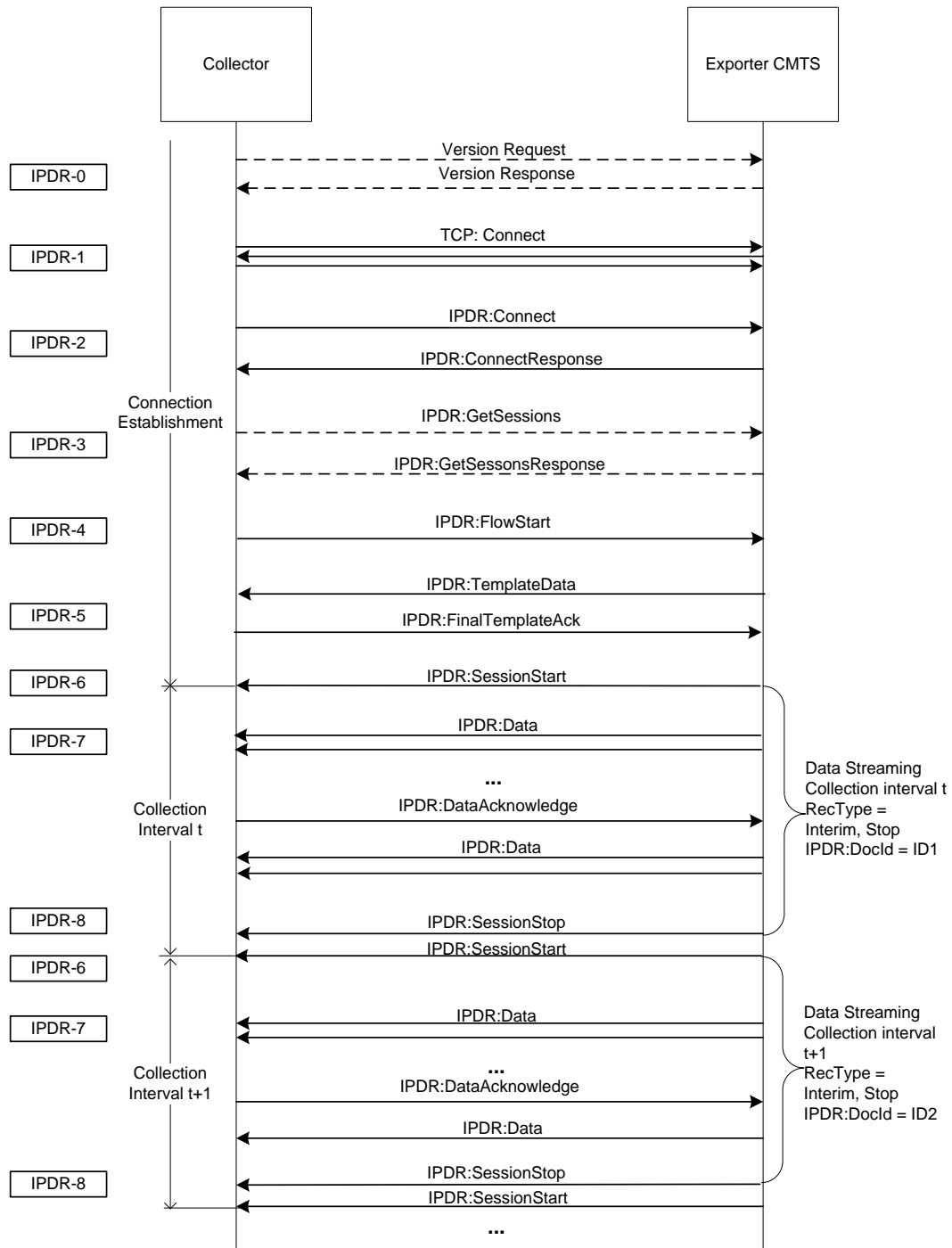

Figure 8-3 - Sequence Diagram for DOCSIS Time Interval Session Streaming Requirements

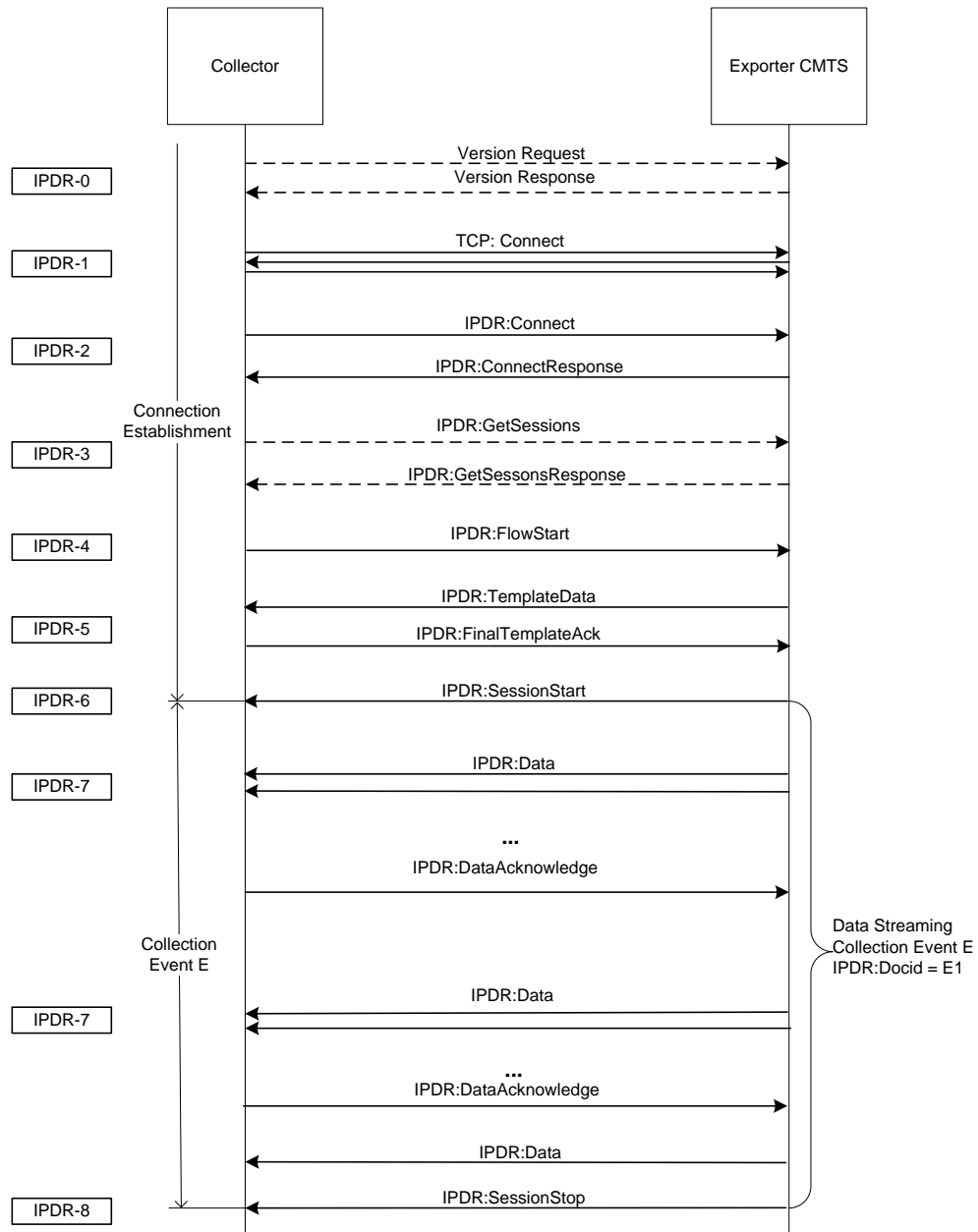

Figure 8-4 - Sequence Diagram for DOCSIS Event Based Session Streaming Requirement

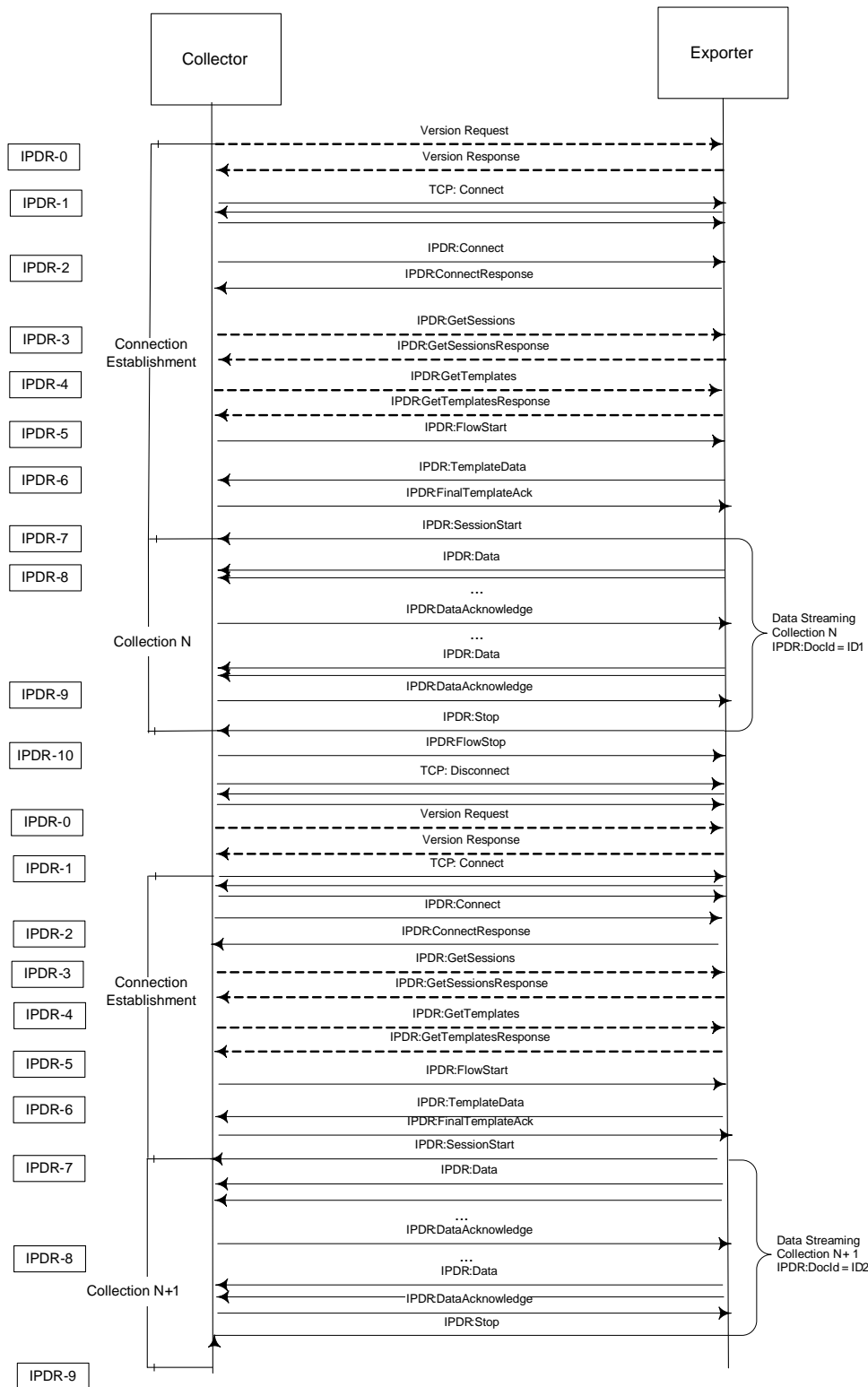

Figure 8-5 - Sequence Diagram for DOCSIS Ad-hoc Based Session Streaming Requirement

**Table 8-3 - DOCSIS IPDR Collection Methodologies Sequence Diagram Details<sup>214</sup>**

Identifier	Streaming Sequence Diagram Description
IPDR-0	Prior to Streaming Connection, Collector may query Exporter for version request (discovery).
IPDR-1	Collector initiates the TCP connection: Port 4737
IPDR-2	Collector sends IPDR Connect message, sets capabilities flags and KeepAlive value Exporter (CCAP) replies with IPDR ConnectResponse message.
IPDR-3	Collector may request Sessions description to know what session ID and associated templates to use for streaming by GetSessions message request. Exporter (CCAP) reply with the GetSessionsResponse message.
IPDR-4	Following the GetSessionsResponse message the Collector may request template descriptions for the Session ID of interest by sending a GetTemplates message Exporter (CCAP) replies with the GetTemplatesResponse message.
IPDR-5	Collector is ready to start receiving data. Sends IPDR FlowStart message.
IPDR-6	Exporter (CCAP) sends a TemplateData message. Collector responds with FinalTemplateData message.
IPDR-7	Exporter (CCAP) starts the Session by sending IPDR SessionStart message.
IPDR-8	Data is streamed by Exporter (CCAP) and acknowledged by Collector IPDR DataAcknowledge messages.
IPDR-9	Exporter (CCAP) closes the IPDR Session with a SessionStop.
IPDR-10	Collector sends a IPDR FlowStop message to indicate that it is no longer able to participate in a particular session.
	Repeat Steps IPDR-6 through IPDR-9 based on the provisioned collection interval.

Figure 8-6 shows typical interaction between Collector and Exporter when multiple sessions are used. In this particular example Collector uses ad-hoc and event based session ("Session 1" and "Session 3" respectively) to retrieve initial state and subsequent changes of CMTS-TOPOLOGY. Another time interval based session ("Session 2") is used for SAMIS-TYPE-2 service. This example has the following assumptions:

- The event session is a time interval session
- The CCAP time interval is in sync with the wall clock. Sessions 2 and 3 have the same time interval t.
- Keep Alive, Data Ack and other messages are omitted for clarity the example.
- Each IPDR session is carried in a separated IPDR connection.

<sup>214</sup> Modified per CCAP-OSSIV3.1-15.1390-2 on 11/11/15 by KB

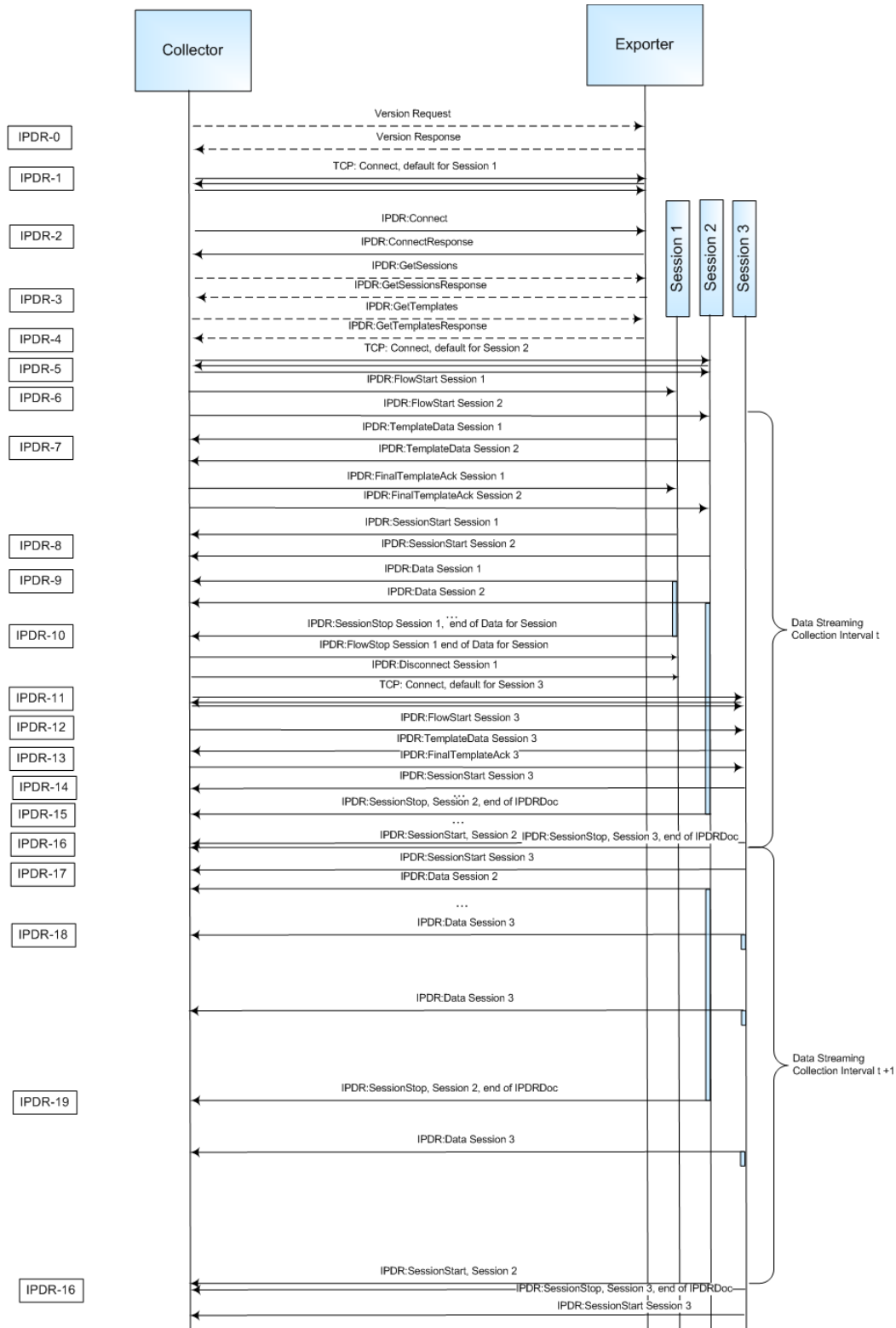

Figure 8-6 - Sequence Diagram for a Multisession Streaming Example

**Table 8-4 - Multisession Streaming Example Sequence Diagram Details<sup>215</sup>**

Identifier	Streaming Sequence Diagram Description
IPDR-0	Prior to Streaming Connection, Collector may query Exporter (CCAP) for version request (discovery).
IPDR-1	Collector initiates the TCP connection: Port 4737. This connection will carry session 1.
IPDR-2	Collector sends IPDR Connect message, sets capabilities flags and KeepAlive value. Exporter (CCAP) replies with IPDR ConnectResponse message.
IPDR-3	Collector may request Sessions description to know what session ID and associated templates to use for streaming by GetSessions message request. Exporter (CCAP) replies with the GetSessionsResponse message.
IPDR-4	Collector requests templates to make sure they match expected configuration. Exporter (CCAP) replies with the GetTemplatesResponse message.
IPDR-5	Collector initiates the second TCP connection: Port 4737 for session 2.
IPDR-6	Collector is ready to start receiving data. Collector sends IPDR FlowStart messages for sessions 1 and 2.
IPDR-7	Exporter (CCAP) sends a TemplateData messages for sessions 1 and 2. Collector responds with FinalTemplateData message.
IPDR-8	Exporter (CCAP) starts the Sessions 1 and 2 by sending IPDR SessionStart message.
IPDR-9	Exporter (CCAP) sends data for Sessions 1 and 2.
IPDR-10	Exporter (CCAP) closes the IPDR Session 1 with a SessionStop and reasonCode 'end of data for session'. Subsequently the Exporter sends FlowStop and Disconnect message.
IPDR-11	Collector initiates the TCP connection: Port 4737 for session 3
IPDR-12	Collector previously knew the IPDR Service Definition sessions and the associated templates. Therefore, the Collector is ready to start receiving data and sends IPDR FlowStart message for session 3.
IPDR-13	Exporter (CCAP) sends a TemplateData messages for session 3. Collector responds with FinalTemplateData message.
IPDR-14	Exporter (CCAP) starts the Session 3 by sending IPDR SessionStart message.
IPDR-15	When there is no more data for the Exporter (CCAP) to send for session 2, the Exporter sends a SessionStop message with reasonCode 'end of IPDRDoc'. The Exporter maintains the connection waiting for the next time interval for Session 2.
IPDR-16	At the time of the expire of the time interval session 3 is terminated with message SessionStop and reasonCode 'end of IPDRDoc'. Around the same time new IPDR SessionStart messages for sessions 2,3 and sent by the Exporter.
IPDR-17	Exporter (CCAP) sends data for Session 2.
IPDR-18	When available, IPDR data for session 3 is sent by the Exporter (CCAP).
IPDR-19	When there is no more data for the Exporter (CCAP) to send for session 2, the Exporter sends a SessionStop message with reasonCode 'end of IPDRDoc'. The Exporter maintains the connection waiting for the next time interval for Session 2.
IPDR-20	The process continues on IPDR-16 for the closure of session data for the expiring interface and initiate the next cycle.

**8.2.3.6 IPDRDoc Mapping for DOCSIS IPDR Streaming**

The IPDRDoc records may be constructed by the Collector for the purpose of storing or to be communicated to other instances through the Collector's D-interface mentioned in Section 8.2.2.1. The IPDRDoc is identified by a docId that is used to tag all of the IPDR records contained within the document. To do so, IPDRDoc in [IPDR/SP] is scoped to the IPDR/SP Session boundary as described in Section 8.2.3.5.1 and the IPDR/SP transport elements listed in Table 8-5 below.

<sup>215</sup> Modified per CCAP-OSSIV3.1-15.1390-2 on 11/11/15 by KB



**Table 8-5 - IPDRDoc Element/Attribute Mapping**

Element or Attribute of IPDRDoc	IPDR/SP Mapping
docId	IPDR:SP:SessionStart:documentId (see Section 8.2.2.5, item 1.g)
version	3.5.1-A.1; In general this field contains the version content of the schemaName of the first TemplateBlock within a negotiated Template after FinalTemplateDataAck
creationTime	IPDR:SP:SessionStartExporterBootTime
IPDRRecorderInfo	reverse DNS lookup of Exporter IP
IPDRType	Refer to the Data Type section of [IPDR/SP]
ipdr:IPDRCreationTime	Not supported (see Section 8.2.2.5)
ipdr:seqNum	Not supported (see Section 8.2.2.5) IPDR reliable transport is handled via IPDR:SP:DataSequenceNum
IPDRDoc.End (optional)	
Count	reflect number of records After closing the Session (Session Stop): IPDR:SP:DataAcknowledge:SequenceNumber - IPDR:SP:SessionStart:FirstRecordSequenceNumber
endTime	Time since epoch time when SessionStop was received

### 8.2.3.7 Message Detail and IDL Definition

The complete message set defined for IPDR/SP and the normative IDL specification for constructing IPDR/SP messages are defined in [IPDR/SP].

### 8.2.4 CCAP IPDR Specifications Support

The CCAP MUST support [IPDR/SP] as the transport mechanism for all DOCSIS Service Definitions.

The CCAP MUST support data records encoded in IPDR/XDR Encoding Format, per the [IPDR/XDR] specification.

The CCAP MAY support the UDP-based Service Discovery Protocol described in the IPDR Streaming Protocol section in [IPDR/SP].

The CCAP MAY support the advertisement upon request of IPDR capabilities as described in [IPDR/CAPAB]. The retrieval of this file is vendor-dependent. The same information is available by the Service Discovery described above.

#### 8.2.4.1 IPDR Streaming Protocol

The CCAP MUST support the minimum conformance feature set for the IPDR Streaming Protocol as follows:

##### 8.2.4.1.1 IPDR/SP Transport Protocol

The CCAP MUST support IPDR Streaming Protocol [IPDR/SP] over TCP.

##### 8.2.4.1.2 Streaming Flow Control and Messaging

[IPDR/SP] defines three main states in its model: 1) Connection, 2) Flow and 3) Session. Connections are initiated by either Collectors or Exporters. Flows are initiated by Collectors only and Sessions are initiated by Exporters (CCAPs) only. See table 1 of [IPDR/SP] for details.

#### 8.2.4.1.2.1 Streaming Flow Connection and Messaging

The CCAP MUST support a minimum of two IPDR streaming connections.

IPDR streaming includes Template Negotiation allowing Collectors to adjust the data streams to include only the information that is relevant to their systems. The CCAP SHOULD support Template Negotiation for any supported Service Definition; the support of the IPDR/SP message MODIFY TEMPLATE RESPONSE is recommended. If the CCAP implements Template Negotiation capability, then all messages within the Template Negotiation phase MUST be supported as described in the Protocol Sequence section of [IPDR/SP]. If the CCAP does not implement Template Negotiation, a Collector MODIFY TEMPLATE message MUST be replied to with a MODIFY TEMPLATE RESPONSE having a preconfigured Template Set as described in [IPDR/SP].

The CCAP MAY support IPDR Capability File Negotiation. If the CCAP supports IPDR Capability File Negotiation, then Communication Negotiation MUST be supported. Communication Negotiation allows the Exporter and the Collector to negotiate communication parameters. The Communication Negotiation allows both the Collector and the Exporter to acknowledge that they are capable of participating in the exchange of records via IPDR Streaming as and identify their ability to support optional protocol capabilities.

#### 8.2.4.1.2.2 Streaming Flow Sessions

The CCAP MUST support a minimum of one Data Streaming Session per connection.

The CCAP MUST handle a minimum of one Template per Session, which is transmitted to the Collector via the TEMPLATE DATA message as described in [IPDR/SP].

See Section 8.2.3 for the definition of the relationship between IPDR/SP Sessions, [IPDR/XDR] documents, and collection intervals.

#### 8.2.4.1.2.3 Records Collection

A particular Service Definition supports ad-hoc, and event or time interval based data collection in order for the Collector to retrieve initial state through the ad-hoc session followed by subsequent updates through the event or time interval based session.

A typical scenario is for example the IPDR Service Definition CMTS-TOPOLOGY-TYPE that supports ad-hoc and event based sessions. The ad-hoc session allows the Collector to obtain initial topology, and the event based session to obtain subsequent topology updates. To allow a Collector to perform timely synchronous processing of SAMIS flow records (e.g., SAMIS-TYPE-2) along with corresponding topology records, the CCAP SHOULD use the same time base and interval for both a topology event session and a SAMIS interval session. The only difference to open ended event sessions is that Exporter inserts start/stop session messages at regular time intervals while the content of data records is the same. This allows Collector to easily detect when Exporter is done sending flow information and topology (e.g., CMTS-TOPOLOGY-TYPE, CMTS-CM-REG-STATUS-TYPE and CPE-TYPE) for specific interval.

Unless otherwise specified, for an IPDR Service Definition that supports ad-hoc, and time interval and/or event based collection mechanisms, the CCAP MUST support the streaming of the ad-hoc session along with an event based or time interval session of that IPDR Service Definition at the same time where each session could be within the same connection or in separate connections.

Due to the nature of the record streaming at the Exporter, it is up to the Collector to detect duplicate records along simultaneous collection methodologies. Possible scenarios are the following:

- Collector starts ad-hoc session first and doesn't start event session for the same service until ad-hoc session finishes and it gets initial state.
- Collector starts both ad-hoc and corresponding event sessions with the same service at the same time. Exporter doesn't send any events (changes) until is done with sending initial state and stops ad-hoc session.
- Exporter can start sending event records while the ad-hoc session has not terminated. In this case Collector will have to figure out based on the recreation time that event record it has already received is newer than ad-hoc record which represents initial state so it could discard obsolete ad-hoc record.

In the case when adHoc session is established while event session is not for the same service, the CCAP Exporter SHOULD send any events that occur while sending an adHoc "snapshot" within the adHoc session. The CCAP Exporter SHOULD use record type interim(1) for snapshot records and record type stop(2), start(3) or event(4) for event records (record is created, destroyed or changed, respectively). Event records are sent as events occur or are detected. AdHoc session lasts as long as it is necessary to send a snapshot. If in the meantime corresponding event session is established, the CCAP Exporter SHOULD send any subsequent events using that session as it would normally do. It is up to the Collector to make sure there is always either adHoc or event session open for sending events in order to make sure no events are lost.

Refer to Table 8-4 and Figure 8-6 for a multisession streaming example.

### 8.2.5 Requirements for IPv6

The CCAP MUST support IPDR/SP transport for Collectors that have IPv4 addresses [IPDR/SP]. The CCAP SHOULD support an interoperable IPDR/SP transport mechanism for both IPv4 and IPv6 addresses [IPDR/SP].

### 8.2.6 Data Collection Methodologies for DOCSIS IPDR Service Definitions

This specification, as well as [IPDR/SP], defines a mechanism for the Collector and Exporter to coordinate the state control of DOCSIS IPDR Service Definitions that support multiple collection methodologies. In this case the session message provides information about the streaming methodology used for that session id. In other words, an additional session ID of the same service template is associated with a specific collection methodology (e.g., ad-hoc). This is achieved by placing special requirements in the SessionBlock.reserved attribute of the IPDR/SP GET SESSIONS RESPONSE message as follows:

The CCAP MUST define a sessionID for each collection mechanism supported for each IPDR Service Definition.

The CCAP MUST define the SessionBlock.sessionType attribute of the IPDR/SP GET SESSIONS RESPONSE as defined in [IPDR/SP]. The SessionBlock.sessionType attribution is shown below:

```
struct SessionBlock {  
    char sessionId;  
    char sessionType;  
    UTF8String sessionName;  
    UTF8String sessionDescription;  
    int ackTimeInterval;  
    int ackSequenceInterval;  
};
```

The field description for sessionType:

Type of Session: Integer values of first three least significant bits of this field identify the following session types:

- 0 - Equivalent of sessionType Information Not Available
- 1 - Time Interval
- 2 - Adhoc
- 3 - Event
- 4 - Time Based Event

### 8.2.7 IPDR Streaming Protocol Security Model

Refer to [IPDR/SP] for the IPDR/SP Security recommendations. The IPDR/SP Security Model is out of the scope of this specification.

### 8.3 IPDR Service Definition Schemas

This section defines the IPDR Service Definitions required for DOCSIS 3.1. Table 8-6 lists the DOCSIS 3.0 IPDR Service Definitions, corresponding schemas, applicable device and object model specification reference. Refer to Section 8.2 for an overview of the IPDR/SP protocol and Annex B for an overview of the SAMIS IPDR Service Definition. The Service Definition schemas are defined in [DOCSIS-SAMIS-TYPE-1] and [DOCSIS-SAMIS-TYPE-2].

**Table 8-6 - DOCSIS 3.1 IPDR Service Definitions and Schemas<sup>216</sup>**

Information Model Reference	Schema
[DOCSIS-SAMIS-TYPE-1] [DOCSIS-SAMIS-TYPE-2]	Subscriber Account Management Interface Specification (SAMIS) Service Definition: SAMIS-TYPE-1 Schema Definition: DOCSIS-SAMIS-TYPE-1_<version> Subscriber Account Management Interface Specification (SAMIS Optimized) Service Definition: SAMIS-TYPE-2 Schema Definition: DOCSIS-SAMIS-TYPE-2_<version>
[DOCSIS-DIAG-LOG-TYPE] [DOCSIS-DIAG-LOG-EVENT-TYPE] [DOCSIS-DIAG-LOG-DETAIL-TYPE]	Diagnostic Log Service Definition: DIAG-LOG-TYPE Schema Definition: DOCSIS-DIAG-LOG-TYPE_<version> Diagnostic Log Event Service Definition: DIAG-LOG-EVENT-TYPE Schema Definition: DOCSIS-DIAG-LOG-EVENT-TYPE_<version> Diagnostic Log Detail Service Definition: DIAG-LOG-DETAIL-TYPE Schema Definition: DOCSIS-DIAG-LOG-DETAIL-TYPE_<version>
[DOCSIS-SPECTRUM-MEASUREMENT-TYPE]	Spectrum Measurement Service Definition: SPECTRUM-MEASUREMENT-TYPE Schema Definition: DOCSIS-SPECTRUM-MEASUREMENT-TYPE_<version>
[DOCSIS-CMTS-CM-REG-STATUS-TYPE] [DOCSIS-CMTS-CM-US-STATS-TYPE]	CMTS CM Registration Status Information Service Definition: CMTS-CM-REG-STATUS-TYPE Schema Definition: DOCSIS-CMTS-CM-REG-STATUS-TYPE_<version> CMTS CM Upstream Status Information Service Definition: CMTS-CM-US-STATS-TYPE Schema Definition: DOCSIS-CMTS-CM-US-STATS-TYPE_<version>
[DOCSIS-CMTS-TOPOLOGY-TYPE]	CMTS Topology Service Definition: CMTS-TOPOLOGY-TYPE Schema Definition: DOCSIS-CMTS-TOPOLOGY-TYPE_<version>
[DOCSIS-CPE-TYPE]	CPE Service Definition: CPE-TYPE Schema Definition: DOCSIS-CPE-TYPE_<version>
[DOCSIS-CMTS-US-UTIL-STATS-TYPE] [DOCSIS-CMTS-DS-UTIL-STATS-TYPE] [DOCSIS-CMTS-CM-SERVICE-FLOW-TYPE]	CMTS Upstream Utilization Statistics Service Definition: CMTS-US-UTIL-STATS-TYPE Schema Definition: DOCSIS-CMTS-US-UTIL-STATS-TYPE_<version> CMTS Downstream Utilization Statistics Service Definition: CMTS-DS-UTIL-STATS-TYPE Schema Definition: DOCSIS-CMTS-DS-UTIL-STATS-TYPE_<version> CMTS Service Flow Information Service Definition: CMTS-CM-SERVICE-FLOW-TYPE Schema Definition: DOCSIS-CMTS-CM-SERVICE-FLOW-TYPE_<version>

<sup>216</sup> Modified per CCAP-OSSIV3.1-15.1390-2 on 11/11/15 by KB

Information Model Reference	Schema
[DOCSIS-CMTS-CM-DS-OFDM-PROFILE-TYPE] [DOCSIS-CMTS-CM-DS-OFDM-STATUS-TYPE] [DOCSIS-CMTS-CM-US-OFDMA-PROFILE-TYPE] [DOCSIS-CMTS-CM-US-OFDMA-STATUS-TYPE]	CMTS CM Downstream Profile Status Service Definition: DOCSIS-CMTS-CM-DS-OFDM-PROFILE-STATUS-TYPE Schema Definition: DOCSIS-CMTS-CM-DS-OFDM-PROFILE-STATUS-TYPE_<version> CMTS CM Upstream OFDMA Profile Status Service Definition: DOCSIS-CMTS-CM-US-OFDMA-PROFILE-STATUS-TYPE Schema Definition: DOCSIS-CMTS-CM-US-OFDMA-PROFILE-STATUS-TYPE_<version> CMTS CM Upstream OFDMA Status Service Definition: DOCSIS-CMTS-CM-US-OFDMA-STATUS-TYPE Schema Definition: DOCSIS-CMTS-CM-US-OFDMA-STATUS-TYPE_<version>
[DOCSIS-DS-OFDM-PROFILE-STATS-TYPE] [DOCSIS-US-OFDMA-PROFILE-STATS-TYPE]	Downstream OFDM Profile Statistics Service Definition: DOCSIS-DS-OFDM-PROFILE-STATS-TYPE Schema Definition: DOCSIS-DS-OFDM-PROFILE-STATS-TYPE_<version> Upstream OFDMA Profile Statistics Service Definition: DOCSIS-US-OFDMA-PROFILE-STATS-TYPE Schema Definition: DOCSIS-US-OFDMA-PROFILE-STATS-TYPE_<version>

The DOCSIS IPDR Service Definitions are XML schemas derived from the IPDR Master Schema document (IPDRDoc). See Section 8.2.2.3 for details of the IPDR Master Schema. This specification names DOCSIS IPDR Service Definitions in the form of DOCSIS-**<SERVICE-NAME>-TYPE** (e.g., DOCSIS-SAMIS-TYPE-1, DOCSIS-DIAG-LOG-TYPE).

In addition to the conventional IPDR Service Definition models, this specification defines Object Model Schemas (Auxiliary Schemas) to represent network components being referenced by the Service Definitions themselves. For example, the DOCSIS-CMTS-INFO Auxiliary Schema offers Topology information at the Physical and MAC layer of the CMTS-CM arrangements. For the same example, a DOCSIS Service Definition (service aware) can include the object schema DOCSIS-CMTS-INFO to complete the CM-CMTS identification and to offer context for the statistics and parameters reported in the document records. This modular abstraction allows the definition of different schema documents for the same Service Definition at different elements of the collection infrastructure. Refer to Annex C for a list of Auxiliary Schemas defined for DOCSIS 3.1.

One example is the SAMIS model that supports two different models (see detailed SAMIS requirements in Annex B):

- The Service Definition Schema DOCSIS-SAMIS-TYPE-1

Each document record contains the information modeled by the Service Definition DOCSIS-CMTS-INFO. CMTS-CM related information is duplicated for each SAMIS record.

- The Service Definition Schema DOCSIS-SAMIS-TYPE-2

Each document record contains a reference to the last updated DOCSIS-CMTS-INFO, reducing the amount of data sent over the network. DOCSIS-CMTS-INFO information is sent periodically (e.g., any time an update to the CMTS-CM Status is performed). The collector system is in charge of correlating the information received from records of DOCSIS-SAMIS-TYPE-2 and DOCSIS-CMTS-INFO to re-create the equivalent record obtained when using the DOCSIS-SAMIS-TYPE-1 Service Definition schema.

This section defines the minimum set of objects required to support the DOCSIS 3.0 IPDR Service Definitions. The CCAP MAY define IPDR Service Definitions which extend the DOCSIS requirements to include vendor-specific features.

### 8.3.1 Requirements for DOCSIS SAMIS Service Definitions

The CCAP MUST implement SAMIS-TYPE-1 as specified in Annex B.

The CCAP MUST implement SAMIS-TYPE-2 as specified in Annex B.

**8.3.1.1 Records Collection**

Subscriber Usage Billing Records report the absolute traffic counter values for each Service Flow that has become active during the billing collection interval as seen at the end of the interval. Normal Service Flows used by a Cable Modem or Class or Service (Subscriber) are reported. Group Service Flows are reported by Service Flow without CM association. The collection interval is defined as the time between:

- The creation of the previous billing document denoted as  $T_{prev}$ .
- The creation of the current billing document denoted as  $T_{now}$ .

In reference to Figure 8-7 below, there are two kinds of records reported for a SFID/SID in the current billing document: 1) SFIDs/SIDs that are still running at the time the billing document is created (called 'Interim' records) and 2) terminated SFIDs/SIDs that have been deleted and logged during the collection interval (called 'Stop' records). The CCAP MUST report 'Interim' records at the end of the collection interval. The CCAP MUST NOT record a provisioned or admitted state SF that was deleted before it became active in the billing document, even though it was logged by the CCAP.

The CCAP MUST report any currently running SFIDs/SIDs using  $T_{now}$  as the timestamp for its counters and identify them in the IPDR RecType element as 'Interim'. The CCAP MUST report a terminated SFIDs/SIDs only once in the current billing document. Terminated SFIDs/SIDs have a deletion time ( $T_{del}$ ) later than  $T_{prev}$ . A CCAP MUST report a terminated SFID/SID using its  $T_{del}$  from the log as the timestamp for its counters and identify it in the IPDR RecType element as 'Stop'. Note that the timestamps are based on the formatter's reporting times. Since the collection cycle may vary over time, the reporting times in the billing document can be used to construct an accurate time base over sequences of billing documents.

In the example shown in Figure 8-7 below there are four Service Flows recorded for a Subscriber in the current billing document being created at  $T_{now}$ . SFa is a long running SF that was running during the previous collection interval (it has the same SFID in both the current and the previous billing documents). SFa was recorded as type Interim at  $T_{prev}$  in the previous billing document and is recorded again as type Interim at  $T_{now}$  in the current document. SFb is a running SF that was created during the current collection interval. SFb is recorded as type Interim for the first time at  $T_{now}$  in the current document. SFc is a terminated SF that was running during the previous collection interval but was deleted and logged during the current collection interval. SFc was recorded respectively as type Interim at  $T_{prev}$  in the previous billing document and is reported as type Stop at the logged  $T_{del(c)}$  in the current document. SFd is a terminated SF that was both created and deleted during the current collection interval. SFd is reported only once as type Stop at the logged  $T_{del(d)}$  in the current billing document only.

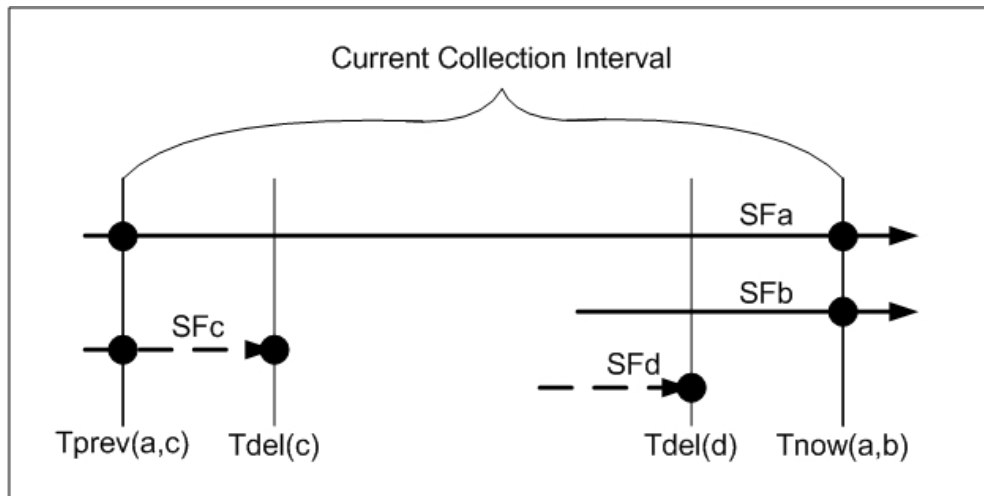

**Figure 8-7 - Billing Collection Interval Example**

The CCAP MUST support streaming of SAMIS-TYPE-1 and SAMIS-TYPE-2 record collections as a time interval session and an ad-hoc session. The CCAP MUST support a minimum collection interval of 15 minutes and a maximum collection interval of 1440 minutes with a default of 15 minutes for time interval session streaming of SAMIS-TYPE-1 and SAMIS-TYPE-2 records. The CCAP SHOULD support a minimum collection interval of 5 minutes for time interval session streaming of SAMIS-TYPE-1 and SAMIS-TYPE-2.

### 8.3.2 Requirements for DOCSIS Spectrum Measurement Service Definition

The CCAP MUST implement SPECTRUM-MEASUREMENT-TYPE as specified in [DOCSIS-SPECTRUM-MEASUREMENT-TYPE].

#### 8.3.2.1 Record Collection

This Service Definition defines the IPDR Streaming using a two-step process:

- SNMP or other configuration management interface such as CLI is used to configure the diagnostic (i.e., create the interface and attributes; destroy the interface).
- IPDR/SP is used to stream the measurement statistics (large data set).

Spectrum Measurement records report the spectrum measurement statistics for all the pre-configured interfaces and their attributes as specified in [DOCSIS-SPECTRUM-MEASUREMENT-TYPE].

The CCAP MUST support streaming of SPECTRUM-MEASUREMENT-TYPE record collections as a time interval session and an ad-hoc session. The rate at which records are streamed when only one interface is configured will not exceed the estimated time interval defined in [DOCSIS-SPECTRUM-MEASUREMENT-TYPE]. If more than one interface is configured, that rate can be lower than the estimated time interval defined in [DOCSIS-SPECTRUM-MEASUREMENT-TYPE].

### 8.3.3 Requirements for DOCSIS Diagnostic Log Service Definitions

The CCAP MUST implement DIAG-LOG-TYPE as specified in [DOCSIS-DIAG-LOG-TYPE].

The CCAP MUST implement DIAG-LOG-EVENT-TYPE as specified in [DOCSIS-DIAG-LOG-EVENT-TYPE].

The CCAP MUST implement DIAG-LOG-DETAIL-TYPE as specified in [DOCSIS-DIAG-LOG-DETAIL-TYPE].

#### 8.3.3.1 Record Collection

This Service Definition defines the IPDR Streaming using a two-step process:

- SNMP or other configuration management interface such as CLI is used to configure the Diagnostic Log.
- IPDR/SP is used to stream the Diagnostic Log instances.

The CCAP MUST support streaming of DIAG-LOG-TYPE record collections as an ad-hoc session.

The CCAP MUST support streaming of DIAG-LOG-EVENT-TYPE record collections as an event session.

The CCAP MUST support streaming of DIAG-LOG-DETAIL-TYPE record collections as a time interval session, an ad-hoc session and an event session.

For event-based Diagnostic Log records, the CCAP streams the record when the event is logged in the Diagnostic Log. For time interval based Diagnostic Log records, the CCAP streams a snapshot of the Diagnostic Log. The CCAP MUST support a minimum collection interval of 5 minutes and a maximum collection interval of 1440 minutes with a default of 15 minutes for time interval session streaming of the Diagnostic Log records.

### 8.3.4 Requirements for DOCSIS CMTS CM Registration Status Service Definition

The CCAP MUST implement CMTS-CM-REG-STATUS-TYPE as specified in [DOCSIS-CMTS-CM-REG-STATUS-TYPE].

#### 8.3.4.1 Record Collection

This Service Definition defines the IPDR Streaming using a two-step process:

- SNMP or other configuration management interface such as CLI is used to configure CMTS CM Registration Status service definition.
- IPDR/SP is used to stream CMTS CM Registration Status instances.

The CCAP MUST support streaming of CMTS-CM-REG-STATUS-TYPE record collections as a time interval session, an ad-hoc session and an event session. The CCAP MUST support a minimum collection interval of 5 minutes and a maximum collection interval of 1440 minutes with a default of 15 minutes for time interval session streaming of the CMTS-CM-REG-STATUS-TYPE records.

### 8.3.5 Requirements for DOCSIS CMTS CM Upstream Status Service Definition

The CCAP MUST implement CMTS-CM-US-STATS-TYPE as specified in [DOCSIS-CMTS-CM-US-STATS-TYPE].

#### 8.3.5.1 Record Collection

This Service Definition defines the IPDR Streaming using a two-step process:

- SNMP or other configuration management interface such as CLI is used to configure CMTS CM Upstream Status service definition.
- IPDR/SP is used to stream CMTS CM Upstream Status instances.

The CCAP MUST support streaming of CMTS-CM-US-STATS-TYPE record collections as a time interval session and an ad-hoc session. The CCAP MUST support a minimum collection interval of 5 minutes and a maximum collection interval of 1440 minutes with a default of 15 minutes for time interval session streaming of the CMTS-CM-US-STATS-TYPE records.

### 8.3.6 Requirements for DOCSIS CMTS Topology Service Definition

The CCAP MUST implement CMTS-TOPOLOGY-TYPE as specified in [DOCSIS-CMTS-TOPOLOGY-TYPE].

#### 8.3.6.1 Record Collection

This Service Definition defines the IPDR Streaming using a two-step process:

- SNMP or other configuration management interface such as CLI is used to configure the topology.
- IPDR/SP is used to stream the topology information.

The CCAP MUST support streaming of CMTS-TOPOLOGY-TYPE record collections as an ad-hoc session and event session.

### 8.3.7 Requirements for DOCSIS CPE Service Definition

The CCAP MUST implement CPE-TYPE as specified in [DOCSIS-CPE-TYPE].



### **8.3.7.1 Record Collection**

This Service Definition defines the IPDR Streaming using a two-step process:

- SNMP or other configuration management interface such as CLI is used to configure DOCSIS CPE service definition.
- IPDR/SP is used to stream DOCSIS CPE instances.

The CCAP MUST support streaming of CPE-TYPE record collections as an ad-hoc session and event session.

### **8.3.8 Requirements for DOCSIS CMTS Upstream Utilization Statistics Service Definition**

The CCAP MUST implement CMTS-US-UTIL-STATS-TYPE as specified in [DOCSIS-CMTS-US-UTIL-STATS-TYPE].

#### **8.3.8.1 Record Collection**

This Service Definition defines the IPDR Streaming using a two-step process:

- SNMP or other configuration management interface such as CLI is used to configure CMTS Upstream Utilization Statistics service definition.
- IPDR/SP is used to stream CMTS Upstream Utilization Statistics instances.

The CCAP MUST create CMTS-US-UTIL-STATS-TYPE records using the configured utilization interval. The CCAP MUST support streaming of CMTS-US-UTIL-STATS-TYPE record collections as an event based session.

### **8.3.9 Requirements for DOCSIS CMTS Downstream Utilization Statistics Service Definition**

The CCAP MUST implement CMTS-DS-UTIL-STATS-TYPE as specified in [DOCSIS-CMTS-DS-UTIL-STATS-TYPE].

#### **8.3.9.1 Record Collection**

This Service Definition defines the IPDR Streaming using a two-step process:

- SNMP or other configuration management interface such as CLI is used to configure CMTS Downstream Utilization Statistics service definition.
- IPDR/SP is used to stream CMTS Downstream Utilization Statistics instances.

The CCAP MUST create CMTS-DS-UTIL-STATS-TYPE records using the configured utilization interval. The CCAP MUST support streaming of CMTS-DS-UTIL-STATS-TYPE record collections as an event based session.

### **8.3.10 Requirements for DOCSIS CMTS CM Service Flow Service Definition**

The CCAP MUST implement CMTS-CM-SERVICE-FLOW-TYPE as specified in [DOCSIS-CMTS-CM-SERVICE-FLOW-TYPE].

#### **8.3.10.1 Record Collection**

This Service Definition defines the IPDR Streaming using a two-step process:

- SNMP or other configuration management interface such as CLI is used to configure the CMTS CM SERVICE FLOW Service Definition.
- IPDR/SP is used to stream the CMTS CM SERVICE FLOW instances.

The CCAP MUST support streaming of CMTS-CM-SERVICE-FLOW-TYPE record collections as an ad-hoc session and event session. The CCAP MUST report all Active service flows on an ad-hoc session. The CCAP MUST report all new service flows that become active on an event session.

### 8.3.11 Requirements for IP Multicast Statistics Service Definition<sup>217</sup>

The CCAP MUST implement IP-MULTICAST-STATS-TYPE as specified in [DOCSIS-IP-MULTICAST-STATS-TYPE].

#### 8.3.11.1 Record Collection

This Service Definition defines the IPDR Streaming using a two-step process:

- SNMP or other configuration management interface such as CLI is used to configure the IP Multicast Statistics Service Definition.
- IPDR/SP is used to stream the IP-MULTICAST-STATS-TYPE record instances.

The CCAP MUST support streaming of IP-MULTICAST-STATS-TYPE record collections as a time interval session. The CCAP MUST support a minimum collection interval of 5 minutes and a maximum collection interval of 1440 minutes with a default of 15 minutes for time interval session streaming of the IP-MULTICAST-STATS-TYPE records.

### 8.3.12 Requirements for DOCSIS CMTS CM Downstream OFDM Service Definition<sup>218</sup>

The CCAP MUST implement CMTS-CM-DS-OFDM-STATUS-TYPE as specified in [DOCSIS-CMTS-CM-DS-OFDM-STATUS-TYPE].

#### 8.3.12.1 Record Collection

This Service Definition defines the IPDR Streaming using a two-step process:

- SNMP or other configuration management interface such as CLI is used to configure the CMTS CM Downstream OFDM Service Definition.
- IPDR/SP is used to stream the CMTS-CM-DS-OFDM-STATUS-TYPE record instances.

The CCAP MUST support streaming of CMTS-CM-DS-OFDM-STATUS-TYPE record collections as a time interval and session. The CCAP MUST support a minimum collection interval of 5 minutes and a maximum collection interval of 1440 minutes with a default of 15 minutes for time interval session streaming of the CMTS-CM-DS-OFDM-STATUS-TYPE records. The CCAP MUST report all new partial service events on an event session.

### 8.3.13 Requirements for DOCSIS CMTS CM Downstream OFDM Profile Service Definition<sup>219</sup>

The CCAP MUST implement CMTS-CM-DS-OFDM-PROFILE-STATUS-TYPE as specified in [DOCSIS-CMTS-CM-DS-OFDM-PROFILE-TYPE].

#### 8.3.13.1 Record Collection

This Service Definition defines the IPDR Streaming using a two-step process:

- SNMP or other configuration management interface such as CLI is used to configure the CMTS CM Downstream OFDM Profile Service Definition.

<sup>217</sup> Added per CCAP-OSSv3.1-N-15.1390-2 on 11/11/15 by KB.

<sup>218</sup> Added per CCAP-OSSv3.1-N-15.1390-2 on 11/11/15 by KB.

<sup>219</sup> Added per CCAP-OSSv3.1-N-15.1390-2 on 11/11/15 by KB.

- IPDR/SP is used to stream the CMTS-CM-DS-OFDM-PROFILE-STATUS-TYPE record instances.

The CCAP MUST support streaming of CMTS-CM-DS-OFDM-PROFILE-STATUS-TYPE record collections as a time interval and session. The CCAP MUST support a minimum collection interval of 5 minutes and a maximum collection interval of 1440 minutes with a default of 15 minutes for time interval session streaming of the CMTS-CM-DS-OFDM-PROFILE-STATUS-TYPE records. The CCAP MUST report all new partial channel events on an event session.

### **8.3.14 Requirements for DOCSIS CMTS CM Upstream OFDMA Service Definition<sup>220</sup>**

The CCAP MUST implement CMTS-CM-US-OFDMA-STATUS-TYPE as specified in [DOCSIS-CMTS-CM-US-OFDMA-STATUS-TYPE].

#### **8.3.14.1 Record Collection**

This Service Definition defines the IPDR Streaming using a two-step process:

- SNMP or other configuration management interface such as CLI is used to configure the CMTS CM Upstream OFDMA Service Definition.
- IPDR/SP is used to stream the CMTS-CM-US-OFDMA-STATUS-TYPE record instances.

The CCAP MUST support streaming of CMTS-CM-US-OFDMA-STATUS-TYPE record collections as a time interval and session. The CCAP MUST support a minimum collection interval of 5 minutes and a maximum collection interval of 1440 minutes with a default of 15 minutes for time interval session streaming of the CMTS-CM-US-OFDMA-STATUS-TYPE records. The CCAP MUST report all new partial service events on an event session.

### **8.3.15 Requirements for DOCSIS CMTS CM Upstream OFDMA Profile Service Definition<sup>221</sup>**

The CCAP MUST implement CMTS-CM-US-OFDMA-PROFILE-STATUS-TYPE as specified in [DOCSIS-CMTS-CM-US-OFDMA-PROFILE-TYPE].

#### **8.3.15.1 Record Collection**

This Service Definition defines the IPDR Streaming using a two-step process:

- SNMP or other configuration management interface such as CLI is used to configure the CMTS CM Upstream OFDMA Profile Service Definition.
- IPDR/SP is used to stream the CMTS-CM-US-OFDMA-PROFILE-STATUS-TYPE record instances.

The CCAP MUST support streaming of CMTS-CM-US-OFDMA-PROFILE-STATUS-TYPE record collections as a time interval and session. The CCAP MUST support a minimum collection interval of 5 minutes and a maximum collection interval of 1440 minutes with a default of 15 minutes for time interval session streaming of the CMTS-CM-US-OFDMA-PROFILE-STATUS-TYPE records. The CCAP MUST report all new partial channel events on an event session.

### **8.3.16 Requirements for DOCSIS Downstream OFDM Profile Statistics Service Definition<sup>222</sup>**

The CMTS MUST implement DS-OFDM-PROFILE-STATS-TYPE as specified in [DOCSIS-DS-OFDM-PROFILE-STATS-TYPE].

---

<sup>220</sup> Added per CCAP-OSSiv3.1-N-15.1390-2 on 11/11/15 by KB.

<sup>221</sup> Added per CCAP-OSSiv3.1-N-15.1390-2 on 11/11/15 by KB.

<sup>222</sup> Added per CCAP-OSSiv3.1-N-15.1390-2 on 11/11/15 by KB.

### **8.3.16.1 Record Collection**

This Service Definition defines the IPDR Streaming using a two-step process:

- SNMP or other configuration management interface such as CLI is used to configure the Downstream OFDM Profile Statistics Service Definition.
- IPDR/SP is used to stream the DS-OFDM-PROFILE-STATS-TYPE record instances.

The CMTS MUST support streaming of DS-OFDM-PROFILE-STATS-TYPE record collections as a time interval session. The CMTS MUST support a minimum collection interval of 1 minute and a maximum collection interval of 60 minutes with a default of 5 minutes for time interval session streaming of the DS-OFDM-PROFILE-STATS-TYPE records.

### **8.3.17 Requirements for DOCSIS Upstream OFDMA Profile Statistics Service Definition<sup>223</sup>**

The CMTS MUST implement US-OFDMA-PROFILE-STATS-TYPE as specified in [DOCSIS-US-OFDMA-PROFILE-STATS-TYPE].

#### **8.3.17.1 Record Collection**

This Service Definition defines the IPDR Streaming using a two-step process:

- SNMP or other configuration management interface such as CLI is used to configure the DOCSIS Upstream OFDMA Profile Statistics Service Definition.
- IPDR/SP is used to stream the US-OFDMA-PROFILE-STATS-TYPE record instances.

The CMTS MUST support streaming of US-OFDMA-PROFILE-STATS-TYPE record collections as a time interval session. The CMTS MUST support a minimum collection interval of 1 minute and a maximum collection interval of 60 minutes with a default of 5 minutes for time interval session streaming of the US-OFDMA-PROFILE-STATS-TYPE records.

### **8.3.18 Requirements for Auxiliary Schemas**

The CCAP MUST implement the auxiliary schemas as specified in Annex C.

---

<sup>223</sup> Added per CCAP-OSSlv3.1-N-15.1390-2 on 11/11/15 by KB.

## 9 FAULT MANAGEMENT AND REPORTING REQUIREMENTS

### 9.1 Fault Management Requirements and Transport Protocols

This section defines requirements for remote monitoring/detection, diagnosis, reporting, and correction of problems.

### 9.2 Event Reporting<sup>224</sup>

The CCAP MUST log events using standard mechanisms defined in section 8 of [CM-OSSiv3.1].

The CCAP MUST support all Mandatory ("M") CMTS MIB objects that have an SNMP access type of accessible for SNMP Notifications ("Acc-FN") in Annex A and in Annex A of [L2VPN].

The CCAP MUST log events when loss of fan, loss of power supply, and temperature issues are detected. These events are specified in Annex A. The CCAP is expected to implement additional physical and environmental events beyond the three basic ones listed here.

#### 9.2.1 SNMP Usage

In the DOCSIS environment, SNMP is one method is used to achieve the goals of fault management: remote detection, diagnosis, reporting, and correction of CMTS/CCAP network faults.

The CMTS/CCAP sends SNMP notifications to one or more NMSs (subject to operator imposed policy). CMTS/CCAP requirements for SNMP notifications are detailed in Section 9.2.2.1.2. The CMTS/CCAP sends events to a syslog server. The CMTS/CCAP requirements for syslog events are detailed in Section 9.2.2.1.3.

#### 9.2.2 Event Notification

The CMTS/CCAP generates asynchronous events that indicate malfunction situations and notify the operator about important events. The methods for reporting events are defined below:

1. Stored in Local Log (docsDevEventTable from [RFC 4639]).
2. Reported to SNMP entities as an SNMP notification.
3. Sent as a message to a Syslog server.
4. Optionally reported to NETCONF clients as a NETCONF notification.

This specification defines the support of DOCSIS specific events (see Annex D) and IETF events. The former are normally in the form of SNMP notifications. The delivery of IETF Notifications to local log and syslog server is optional.

Event Notifications are enabled and disabled via configuration settings.

Events can be reported to Local Log, Syslog, and/or SNMP notifications based on the configuration settings defined in the EventReportingCfg object (see Section 6.6.9.6.4).

The CMTS and CCAP MUST support event notifications via local event logging.

The CMTS and CCAP MUST support event notifications via Syslog, including limiting/throttling, as specified in [RFC 4639].

The CMTS and CCAP MUST support event notification via SNMP traps, including limiting/throttling, as specified in [RFC 4639].

##### 9.2.2.1 Format of Events

The subsections which follow explain in detail how the CMTS and CCAP reports standard events by any of the following three mechanisms: local event logging, SNMP notification, and Syslog.

---

<sup>224</sup> Modified per CCAP-OSSiv3.1-N-14.1225-1 on 1/7/15 by KB.

Annex D lists all DOCSIS event definitions.

#### 9.2.2.1.1 Local Event Logging

The CCAP MUST maintain Local Log events, defined in [RFC 4639], in local non-volatile storage.

The CMTS and CCAP MAY retain events designated for local volatile storage in local non-volatile storage.

The CCAP Local Log non-volatile storage events MUST persist across reboots.

Events are identical if their EventIds are identical. For identical events occurring consecutively, the CMTS and CCAP MAY choose to store only a single event.

If the CCAP stores as a single event multiple identical events that occur consecutively, the CCAP MUST reflect the most recent event in the event description.

A CMTS MUST maintain Local Log events, defined in Annex D, in local-volatile storage or local non-volatile storage or both. A CMTS MAY retain in local non-volatile storage events designated for local volatile storage.

A CMTS MUST implement its Local Log as a cyclic buffer. The number of entries supported by the CMTS for the Local Log is vendor specific with a minimum of ten entries. The CMTS Local Log MAY persist across reboots. The CMTS MUST provide access to the Local Log events through the docsDevEventTable [RFC 4639].

Aside from the procedures defined in this document, event recording conforms to the requirements of [RFC 4639]. Event descriptions are defined in English. A CMTS MUST implement event descriptors such that no event descriptor is longer than 255 characters, which is the maximum defined for SnmpAdminString [RFC 3411].

The EventId digit is a 32-bit unsigned integer. EventIds ranging [RFC 4639] from 0 to  $(2^{31} - 1)$  are reserved by DOCSIS. The CMTS MUST report in the docsDevEvTable [RFC 4639] the EventId as a 32-bit unsigned integer and convert the EventId from the error codes defined in Annex D to be consistent with this number format.

The CMTS MUST implement EventIds ranging from  $2^{31}$  to  $(2^{32} - 1)$  as vendor-specific EventIds using the following format:

- Bit 31 is set to indicate vendor-specific event

- Bits 30-16 contain the lower 15 bits of the vendor's SNMP enterprise number

- Bits 15-0 are used by the vendor to number events

Section 9.2.2.1.3 describes rules to generate unique EventIds from the error code.

The [RFC 4639] docsDevEvIndex object provides relative ordering of events in the log. The creation of local-volatile and local non-volatile logs necessitates a method for synchronizing docsDevEvIndex values between the two Local Logs after reboot. A CMTS which supports local non-volatile storage MUST adhere to the rules listed below for creating local volatile and local non-volatile logs following a re-boot:

- Renumber the values of docsDevEvIndex maintained in the local non-volatile log beginning with 1.

- Initialize the local volatile log with the contents of the local non-volatile log.

- Use the value of the last restored non-volatile docsDevEvIndex plus one as the docsDevEvIndex for the first event recorded in the new active session's local volatile log.

The CMTS MUST clear both the local volatile and local non-volatile event logs when an event log reset is initiated through an SNMP SET of the docsDevEvControl object [RFC 4639].

#### 9.2.2.1.2 SNMP Notifications

The CCAP MUST implement the generic SNMP notifications according to Annex A.

When any event causes a generic SNMP notification occurrence in a CMTS, the CMTS MUST send notifications if throttling/limiting mechanism [RFC 4639] and other limitations [RFC 3413] do not restrict notification sending.

The CCAP MUST implement SNMP notifications defined in [DOCS-DIAG-MIB] and [DOCS-IF3-MIB].

The CCAP MUST support at least 4 SNMP trap destinations.

The CCAP MUST support the ability to filter traps individually and filter traps by priority level.

A CMTS operating in SNMP v1/v2c NmAccess mode MUST support SNMPv1 and SNMPv2c Traps as defined in [RFC 3416].

A CMTS operating in SNMP Coexistence mode MUST support SNMP notification type 'trap' and 'inform' as defined in [RFC 3416] and [RFC 3413].

The CMTS MUST send notifications for any event, if docsDevEvControl object [RFC 4639], throttling/limiting mechanism [RFC 4639] and [RFC 3413] limitations applied later do not restrict notification sending.

The CMTS MUST NOT report via SNMP notifications vendor-specific events that are not described in instructions submitted with certification testing application documentation.

### 9.2.2.1.3 Syslog

The CCAP MUST support at least 4 Syslog servers as recipients.

The CMTS and CCAP MUST support Syslog messages that communicate interface up/down events, user login/logout events, configuration changes, and access failures.

When the CCAP sends a Syslog message for a DOCSIS-defined event, the CCAP MUST send it in the following format: `<level>TIMESTAMP HOSTNAME CCAP[vendor]: <eventId> text vendor-specific-text`

When the CMTS sends a syslog message for a DOCSIS-defined event, the CMTS MUST send it in the following format: `<level>TIMESTAMP HOSTNAME CMTS[vendor]: <eventId> text vendor-specific-text`

Where:

- *level* is an ASCII representation of the event priority, enclosed in angle brackets, which is constructed as an OR of the default Facility (128) and event priority (0-7). The resulting level ranges between 128 and 135.
- *TIMESTAMP* and *HOSTNAME* follow the format of [RFC 3164]. The single space after *TIMESTAMP* is part of the *TIMESTAMP* field. The single space after *HOSTNAME* is part of the *HOSTNAME* field.
- *vendor* is the vendor name for the vendor-specific syslog messages or DOCSIS for the standard DOCSIS messages.
- *eventId* is an ASCII representation of the INTEGER number in decimal format, enclosed in angle brackets, which uniquely identifies the type of event. The CMTS and CCAP MUST equate the eventId with the value stored in the docsDevEvId object in docsDevEventTable. For the standard DOCSIS events this number is converted from the error code using the following rules:
  - The number is an eight-digit decimal number.
  - The first two digits (left-most) are the ASCII code for the letter in the Error code.
  - The next four digits are filled by 2 or 3 digits between the letter and the dot in the Error code with zero filling in the gap in the left side.
  - The last two digits are filled by the number after the dot in the Error code with zero filling in the gap in the left side.

For example, event D04.2 is converted into 68000402, and Event I114.1 is converted into 73011401. This convention only uses a small portion of available number space reserved for DOCSIS (0 to  $2^{31}-1$ ). The first letter of an error code is always in upper-case. See Annex D for event definitions.

- *text* contains the textual description for the standard DOCSIS event message, as defined in Annex D.
- *vendor-specific-text* contains vendor specific information. This field is optional.

For example, the syslog event for the event D04.2, "ToD Response received - Invalid data format", is as follows:

```
<132>CABLEMODEM[DOCSIS]: <68000402> ToD Response received - Invalid data format
```

The number 68000402 in the example is the number assigned by DOCSIS to this particular event.

The CMTS and CCAP MAY report non-DOCSIS events in the standard syslog message format [RFC 3164] rather than the DOCSIS syslog message format defined above.

When the CMTS or CCAP sends a syslog message for an event not defined in this specification, the CMTS or CCAP MAY send it according to the format and semantics of the elements defined above.

### **9.2.2.2 BIT Values for docsDevEvReporting [RFC 4639]**

Permissible BIT values for [RFC 4639] docsDevEvReporting objects include:

- 1: local(0)
- 2: traps(1)
- 3: syslog(2)
- 4: localVolatile(8)
- 5: stdInterface(9)

Bit-0 means non-volatile Local Log storage and bit-8 is used for volatile Local Log storage (see Section 9.2.2.1). Bit-1 means SNMP Notifications which correspond to both SNMP Trap and SNMP Inform.

For backward compatibility with Pre-3.0 DOCSIS devices, the CMTS MUST support bit-3 in docsDevEvReporting BITS encoding for volatile Local Log storage.

DOCSIS 3.0 devices need to support bit override mechanisms during SNMP SET operations with either one-byte or two-byte BITS encoding for docsDevEvReporting for backward compatibility with Pre-3.0 DOCSIS behavior.

The CMTS MUST use the bit-3 value to set both bit-3 and bit-8 for SNMP SET operations on docsDevEvReporting using a one-byte BITS encoded value; therefore, the CMTS reports bit-3 and bit-8 with identical values for SNMP GET operations.

The CMTS MUST use the bit-8 value to set bit-3 and bit-8 for SNMP SET operations, irrespective of the bit-3 value, on docsDevEvReporting using a two or more byte BITS encoded value.

The CMTS MAY support bit-9 in docsDevEvReporting BITS encoding in accordance with [RFC 4639] definition.

A CMTS that reports an event by SNMP Notification or syslog MUST also report the event by a Local Log (volatile or non-volatile).

Combinations of docsDevEvReporting with traps(1) and/or syslog(2) bits with no Local Log bits (bit-0, bit-3 or bit-8) set are known as unacceptable combinations.

The CMTS MUST reject and report a 'Wrong Value' error for SNMPv2c/v3 PDUs or a 'Bad Value' error for SNMPv1 PDUs for any attempt to set docsDevEvReporting with unacceptable combinations.

The CMTS MUST accept any SNMP SET operation to docsDevEvReporting different than the unacceptable combinations.

The CMTS MUST ignore any undefined bits in docsDevEvReporting on SNMP SET operations and report a zero value for those bits.

Refer to Section 9.2.2.1.1 for details on Local Log requirements for the CMTS.

If CMTS supports both volatile and non-volatile storage, the CMTS MUST maintain the non-volatile storage when both non-volatile Local Log and volatile Local Log bits are set for a specific docsDevEvReporting event priority. If CMTS supports both volatile and non-volatile storage, the CMTS MAY maintain the volatile storage when both non-volatile Local Log and volatile Local Log bits are set for a specific docsDevEvReporting event priority. When both non-volatile Local Log and volatile Local Log bits are set for a specific docsDevEvReporting event priority, the CMTS MUST NOT report duplicate events in the docsDevEventTable.



### 9.2.2.3 Standard Events for CCAP

The CCAP MUST maintain the non-volatile storage when both non-volatile Local Log and volatile Local Log bits are set for a specific event priority, configured in the Reporting attribute of the EventReportingCfg object (see Section 6.6.9.6.4).

The CCAP MAY maintain the volatile storage when both non-volatile Local Log and volatile Local Log bits are set for a specific event priority.

When both non-volatile Local Log and volatile Local Log bits are set for a specific event priority, the CCAP MUST report the event as a single event in the docsDevEventTable.

Event priority levels for the CCAP will use the following categories:

**Emergency(1)** events indicate fatal hardware or software failure that prevent normal system operation (all service are affected).

**Alert(2)** events indicate a major hardware or software failure that causes some service interruption (no redundancy available).

**Critical(3)** events indicate a major hardware or software failure that does not cause an interrupt of the normal data flow. This level of event may be also used when some redundant device was automatically activated to replace the defective device.

**Error(4)** events indicate that an incorrect input signal (external system error) is causing temporary or permanent interruption of the normal data flow.

**Warning(5)** events indicate a minor failure that does not cause any interrupt of the data flow.

**Notice(6)** events indicate that a specified alarm condition has been removed.

**Information(7)** events indicate a milestone or checkpoint in normal operation that could be of particular importance for troubleshooting.

**Debug(8)** events are reserved for vendor-specific events.

The reporting mechanism for each priority can be changed from the default reporting mechanism via the EventReportingCfg object defined in this specification (see Section 6.6.9.6.4).

### 9.2.2.4 Standard DOCSIS Events for CMTS

CMTSs use the same levels of the event priorities as a CM (see [CM-OSSiv3.1]); however, the priority definition of the events is different. Events with the priority level of 'Warning' and less, specify problems that could affect the individual user (for example, individual CM registration problem).

Every CMTS vendor may define their own set of 'Alert' events.

Priority level of 'Error' indicates problems with a group of CMs (for example CMs that share same upstream channel).

Priority level of 'Critical' indicates a problem that affects the whole cable system operation, but is not a faulty condition of the CMTS device.

Priority level of 'Emergency' is vendor-specific and indicates problems with the CMTS hardware or software, which prevents CMTS operation.

During CMTS initialization or reinitialization, the CMTS MUST support, as a minimum, the default event reporting mechanism shown in Table 9-1 or Table 9-2 or Table 9-3.

The CMTS MAY implement default reporting mechanisms above the minimum requirements listed in Table 9-1 or Table 9-2 or Table 9-3 with the exception of the 'Debug' priority level.

The reporting mechanism for each priority could be changed from the default reporting mechanism by using docsDevEvReporting object of DOCS-CABLE-DEVICE-MIB [RFC 4639].

**Table 9-1 - CMTS Default Event Reporting Mechanism Versus Priority (Non-Volatile Local Log Support Only)**

Event Priority	Local Log Non-volatile	SNMP Notification	Syslog	Local Log Volatile
Emergency	Yes	No	No	Not Used
Alert	Yes	No	No	Not Used
Critical	Yes	Yes	Yes	Not Used
Error	Yes	Yes	Yes	Not Used
Warning	Yes	Yes	Yes	Not Used
Notice	Yes	Yes	Yes	Not Used
Informational	No	No	No	Not Used
Debug	No	No	No	Not Used

**Table 9-2 - CMTS Default Event Reporting Mechanism Versus Priority (Volatile Local Log Support Only)**

Event Priority	Local Log Non-volatile	SNMP Notification	Syslog	Local Log Volatile
Emergency	Not Used	No	No	Yes
Alert	Not Used	No	No	Yes
Critical	Not Used	Yes	Yes	Yes
Error	Not Used	Yes	Yes	Yes
Warning	Not Used	Yes	Yes	Yes
Notice	Not Used	Yes	Yes	Yes
Informational	Not Used	No	No	No
Debug	Not Used	No	No	No

**Table 9-3 - CMTS Default Event Reporting Mechanism Versus Priority**

Event Priority	Local Log Non-volatile	SNMP Notification	Syslog	Local Log Volatile
Emergency	Yes	No	No	No
Alert	Yes	No	No	No
Critical	Yes	Yes	Yes	No
Error	No	Yes	Yes	Yes
Warning	No	Yes	Yes	Yes
Notice	No	Yes	Yes	Yes
Informational	No	No	No	No
Debug	No	No	No	No

The CMTS MUST format notifications for standard DOCSIS events as specified in Annex D.

**9.2.3 Event Priorities and Vendor-Specific Events**

This specification defines events that make use of a sub-set of the Event Priority Levels. Vendor-specific events can be defined for any Event Priority Level. Table 9-4 summarizes those considerations.

A CMTS and CCAP MUST assign DOCSIS and vendor specific events as indicated in Table 9-4.

**Table 9-4 - Event Priorities Assignment**

Event Priority	CMTS and CCAP Event Assignment
Emergency	Vendor-Specific
Alert	CMTS and CCAP and Vendor-Specific (optional*)
Critical	CMTS and CCAP and Vendor-Specific (optional*)
Error	CMTS and CCAP and Vendor-Specific (optional*)
Warning	CMTS and CCAP and Vendor-Specific (optional*)
Notice	CMTS and CCAP and Vendor-Specific (optional*)
Information	CMTS and CCAP and Vendor-Specific (optional*)
Debug	Vendor-Specific
Table Note: *Vendor-specific optional event definitions are recommended only where the CCAP allows for sufficient storage of such events.	

#### 9.2.4 NETCONF Notifications

NETCONF Notifications [RFC 5277] is an optional mechanism that provides an asynchronous notification message service built on top of the base NETCONF protocol. The mechanism is based on the concept of clients subscribing to events belonging to named event streams. Clients can associate filter parameters with the subscriptions to receive a defined subset of all events belonging to a stream.

Notification replay is an integral part of the NETCONF Notifications framework. It provides the ability for clients to request sending (or resending) recently generated notifications based on a specific start and an optional stop time. If no stop time is provided, the notification stream will continue until the subscription is terminated.

The CCAP MAY implement NETCONF Notifications towards OSS, as specified in [RFC 5277].

If the CCAP implements NETCONF Notifications towards OSS, the CCAP MUST use the YANG module specified for this purpose in [CCAP-EVENTS-YANG].

#### 9.2.5 Trap and Syslog Throttling, Limiting and Inhibiting

A CMTS MUST support SNMP TRAP/INFORM and syslog throttling and limiting as described in DOCS-CABLE-DEVICE-MIB [RFC 4639], regardless of SNMP mode.

#### 9.2.6 Non-SNMP Fault Management Protocols

The OSS can use a variety of tools and techniques to examine faults at multiple layers. For the IP layer, useful non-SNMP based tools include ping (ICMP Echo and Echo Reply), and trace route (UDP and various ICMP Destination Unreachable flavors). The CMTS MUST support IP end-station generation of ICMP error messages and processing of all ICMP messages.

For the Ethernet layer, Service OAM provides Connectivity Fault Management as specified in [L2VPN].

Syslog requirements are defined in Section 9.2.2.1.3.

### 9.3 Fault Management UML Object Model<sup>225</sup>

#### 9.3.1 Event Notification Objects

The objects for CCAP Event Notification are derived from the docsDevEventTable in [RFC 4639] and are used without modification. They are shown here for completeness.

Reference: [RFC 4639]

<sup>225</sup> Modified per CCAP-OSSiv3.1-N-14.1225-1 on 1/7/15 by KB.

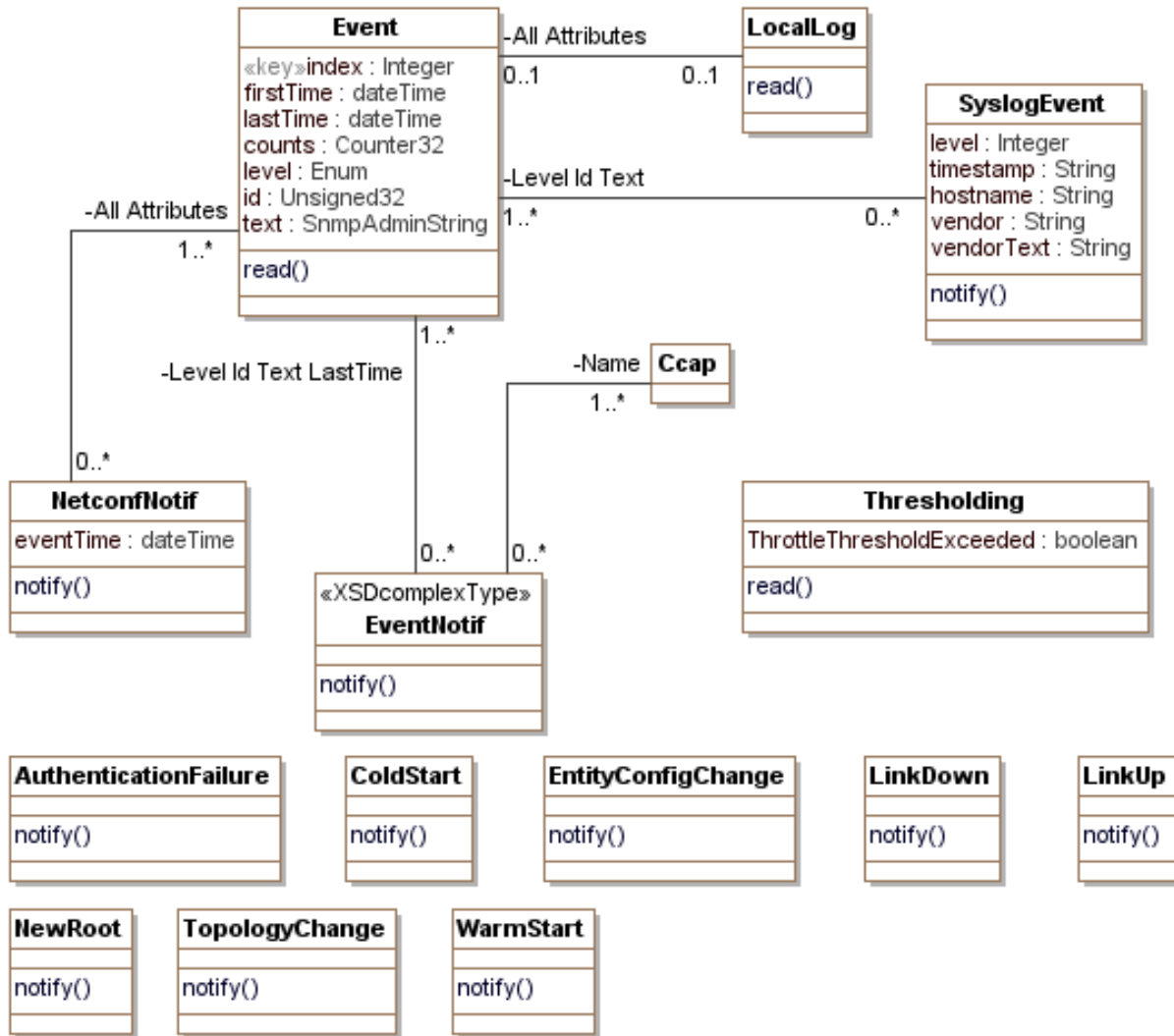

Figure 9-1 - CCAP Event Notification Objects

**9.3.1.1 Event**

This object represents the abstract definition of an event object for the CMTS. The realization of the event object depends on the management protocol that carries the event as an autonomous notification. The event can also be logged in an event log.

**9.3.1.2 EventNotif**

This object represents the abstract definition of an SNMP event notification for the CMTS.

**9.3.1.3 SyslogEvent**

This object represents the abstract definition of a syslog event notification for the CMTS.

**9.3.1.4 NetconfNotif**

This object represents the abstract definition of a NETCONF event notification for the CMTS which supports the NETCONF protocol.

**9.3.1.5 LocalLog**

This object represent the abstract definition of an event stored in the CMTS volatile and/or non-volatile local log.

## Annex A Detailed MIB Requirements (Normative)<sup>226</sup>

This Annex defines the SNMP MIB modules and MIB variables required for DOCSIS 3.1 CMTS and CCAP devices. Refer to Section 2.1 Normative References for the associated MIB files.

**Table A-1 - MIB Implementation Support**

Requirement Type	Table Notation	Description
Deprecated	D	Deprecated objects are optional. If a vendor chooses to implement the object, the object is expected to be implemented correctly according to the MIB definition. If a vendor chooses not to implement the object, an agent is expected to respond with the appropriate error/exception condition (e.g., 'noSuchObject' for SNMPv2c).
Mandatory	M	The object is expected to be implemented correctly according to the MIB definition.
Not Applicable	NA	Not applicable to the device.
Not Supported	N-Sup	An agent is expected to respond with the appropriate error/exception condition (e.g., 'noSuchObject' for SNMPv2c).
Optional	O	A vendor can choose to implement or not implement the object. If a vendor chooses to implement the object, the object is expected to be implemented correctly according to the MIB definition. If a vendor chooses not to implement the object, an agent is expected to respond with the appropriate error/exception condition (e.g., 'noSuchObject' for SNMPv2c).
Obsolete	Ob	In SNMP convention, obsolete objects should not be implemented. This specification allows vendors to implement or not implement obsolete objects. If a vendor chooses to implement an obsoleted object, the object is expected to be implemented correctly according to the MIB definition. If a vendor chooses not to implement the obsoleted object, the SNMP agent is expected to respond with the appropriate error/exception condition (e.g., 'noSuchObject' for SNMPv2c).

**Table A-2 - SNMP Access Requirements<sup>227</sup>**

SNMP Access Type	Table Notation	Description
N-Acc	Not Accessible	The object is not accessible and is usually an index in a table
Read Create	RC	The access of the object is implemented as Read-Create
Read Write	RW	The access of the object is implemented as Read-Write
Read Only	RO	The access of the object is implemented as Read-Only
Read Create or Read Only	RC/RO	The access of the object is implemented as either Read-Create or Read-Only as described in the MIB definition
Read Create or Read Write	RC/RW	The access of the object is implemented as either Read-Create or Read-Write as described in the MIB definition
Read Write or Read Only	RW/RO	The access of the object is implemented as either Read-Write or Read-Only as described in the MIB definition
Accessible for SNMP Notifications	Acc-FN	These objects are used for SNMP Notifications by the CMTS and CM SNMP Agents

### A.1 MIB Object Details

The CMTS and CCAP instantiates SNMP MIB objects based on its configuration and operational parameters.

The CMTS and CCAP upstream channel types can be categorized as "TDMA/ATDMA upstream" and "SCDMA upstream" and "OFDMA upstream".

<sup>226</sup> Modified per CCAP-OSSv3.1-N-15.1249-3 on 3/6/15 by KB; per CCAP-OSSv3.1-N-15.1307-3 on 6/1/15 by KB; per CCAP-OSSv3.1-N-15.1321-1 on 7/20/15 by KB; per CCAP-OSSv3.1-N-15.1376-1 on 11/11/15 by KB.

<sup>227</sup> Modified per CCAP-OSSv3.1-16.1635-1 on 11/17/16 by KB.

**Table A-3 - MIB Object Details<sup>228</sup>**

<b>DOCS-IF-MIB [RFC 4546]</b>		
<b>Object</b>	<b>CMTS</b>	<b>Access</b>
<b>docslfDownstreamChannelTable</b>	M	N-Acc
<b>docslfDownstreamChannelEntry</b>	M	N-Acc
docslfDownChannelId	M	RO
docslfDownChannelFrequency	M	RW/RO
docslfDownChannelWidth	M	RO
docslfDownChannelModulation	M	RW
docslfDownChannelInterleave	M	RW
docslfDownChannelPower	M	RW/RO
docslfDownChannelAnnex	M	RO
docslfDownChannelStorageType	M	RO
<b>Object</b>	<b>CMTS</b>	<b>Access</b>
<b>docslfUpstreamChannelTable</b>	M	N-Acc
<b>docslfUpstreamChannelEntry</b>	M	N-Acc
docslfUpChannelId	M	RO
docslfUpChannelFrequency	M	RC
docslfUpChannelWidth	M	RC
docslfUpChannelModulationProfile	M	RC
docslfUpChannelSlotSize	M	RC/RO
docslfUpChannelTxTimingOffset	M	RO
docslfUpChannelRangingBackoffStart	M	RC
docslfUpChannelRangingBackoffEnd	M	RC
docslfUpChannelTxBackoffStart	M	RC
docslfUpChannelTxBackoffEnd	M	RC
docslfUpChannelScdmaActiveCodes	M	RC
docslfUpChannelScdmaCodesPerSlot	M	RC
docslfUpChannelScdmaFrameSize	M	RC
docslfUpChannelScdmaHoppingSeed	M	RC
docslfUpChannelType	M	RC
docslfUpChannelCloneFrom	M	RC
docslfUpChannelUpdate	M	RC
docslfUpChannelStatus	M	RC
docslfUpChannelPreEqEnable	M	RC
<b>Object</b>	<b>CMTS</b>	<b>Access</b>
<b>docslfQosProfileTable</b>	D	N-Acc
<b>docslfQosProfileEntry</b>	D	N-Acc
docslfQosProfIndex	D	N-Acc

<sup>228</sup> Modified per CCAP-OSSiv3.1-N-16.1423-2 on 5/13/16 by KB; per CCAP-OSSiv3.1-N-16.1510-2 on 5/16/16 by KB; per CCAP-OSSiv3.1-N-16.1528-2 on 11/15/16 by KB; per CCAP-OSSiv3.1-N-16.1544-2 on 11/16/16 by KB; per CCAP-OSSiv3.1-N-16.1553-1 on 11/16/16 by KB; per CCAP-OSSiv3.1-N-16.1566-1 on 11/16/16 by KB; per CCAP-OSSiv3.1-N-16.1610-2 on 11/17/16 by KB; per CCAP-OSSiv3.1-N-16.1618-3 on 11/17/16 by KB; per CCAP-OSSiv3.1-N-16.1684-2 on 12/13/16 by KB; per CCAP-OSSiv3.1-N-16.1686-2 on 12/13/16 by KB.

docslfQosProfPriority	D	RC/RO
docslfQosProfMaxUpBandwidth	D	RC/RO
docslfQosProfGuarUpBandwidth	D	RC/RO
docslfQosProfMaxDownBandwidth	D	RC/RO
docslfQosProfMaxTxBurst	D	RC/RO
docslfQosProfBaselinePrivacy	D	RC/RO
docslfQosProfStatus	D	RC/RO
docslfQosProfMaxTransmitBurst	D	RC/RO
docslfQosProfStorageType	D	RO
<b>Object</b>	<b>CMTS</b>	<b>Access</b>
<b>docslfSignalQualityTable</b>	M	N-Acc
<b>docslfSignalQualityEntry</b>	M	N-Acc
docslfSigQIncludesContention	M	RO
docslfSigQUnerrored	M	RO
docslfSigQCorrected	M	RO
docslfSigQUncorrectable	M	RO
docslfSigQSignalNoise	D	RO
docslfSigQMicroreflections	M	RO
docslfSigQEqualizationData	M	RO
docslfSigQExtUnerrored	M	RO
docslfSigQExtCorrected	M	RO
docslfSigQExtUncorrectable	M	RO
<b>Object</b>	<b>CMTS</b>	<b>Access</b>
docslfDocsisBaseCapability	D	RO
<b>Object</b>	<b>CMTS</b>	<b>Access</b>
<b>docslfCmtsMacTable</b>	M	N-Acc
<b>docslfCmtsMacEntry</b>	M	N-Acc
docslfCmtsCapabilities	M	RO
docslfCmtsSyncInterval	M	RW
docslfCmtsUcdInterval	M	RW/RO
docslfCmtsMaxServiceIds	M	RO
docslfCmtsInsertionInterval	Ob	RW/RO
docslfCmtsInvitedRangingAttempts	M	RW/RO
docslfCmtsInsertInterval	M	RW/RO
docslfCmtsMacStorageType	M	RW/RO
<b>docslfCmtsStatusTable</b>	D	N-Acc
<b>docslfCmtsStatusEntry</b>	D	N-Acc
docslfCmtsStatusInvalidRangeReqs	D	RO
docslfCmtsStatusRangingAborted	D	RO
docslfCmtsStatusInvalidRegReqs	D	RO
docslfCmtsStatusFailedRegReqs	D	RO
docslfCmtsStatusInvalidDataReqs	D	RO
docslfCmtsStatusT5Timeouts	D	RO
<b>docslfCmtsCmStatusTable</b>	D	N-Acc



<b>docslfCmtsCmStatusEntry</b>	D	N-Acc
docslfCmtsCmStatusIndex	D	N-Acc
docslfCmtsCmStatusMacAddress	D	RO
docslfCmtsCmStatusIpAddress	D	RO
docslfCmtsCmStatusDownChannelIfIndex	D	RO
docslfCmtsCmStatusUpChannelIfIndex	D	RO
docslfCmtsCmStatusRxPower	D	RO
docslfCmtsCmStatusTimingOffset	D	RO
docslfCmtsCmStatusEqualizationData	D	RO
docslfCmtsCmStatusValue	D	RO
docslfCmtsCmStatusUnerroreds	D	RO
docslfCmtsCmStatusCorrecteds	D	RO
docslfCmtsCmStatusUncorrectables	D	RO
docslfCmtsCmStatusSignalNoise	D	RO
docslfCmtsCmStatusMicroreflections	D	RO
docslfCmtsCmStatusExtUnerroreds	D	RO
docslfCmtsCmStatusExtCorrecteds	D	RO
docslfCmtsCmStatusExtUncorrectables	D	RO
docslfCmtsCmStatusDocsisRegMode	D	RO
docslfCmtsCmStatusModulationType	D	RO
docslfCmtsCmStatusInetAddressType	D	RO
docslfCmtsCmStatusInetAddress	D	RO
docslfCmtsCmStatusValueLastUpdate	D	RO
docslfCmtsCmStatusHighResolutionTimingOffset	D	RO
<b>docslfCmtsServiceTable</b>	M/O	N-Acc
<b>docslfCmtsServiceEntry</b>	M/O	N-Acc
docslfCmtsServiceId	M/O	N-Acc
docslfCmtsServiceCmStatusIndex	D	RO
docslfCmtsServiceAdminStatus	D	RW/RO
docslfCmtsServiceQosProfile	M/O	RO
docslfCmtsServiceCreateTime	D	RO
docslfCmtsServiceInOctets	D	RO
docslfCmtsServiceInPackets	D	RO
docslfCmtsServiceNewCmStatusIndex	D	RO
<b>docslfCmtsModulationTable</b>	M	N-Acc
<b>docslfCmtsModulationEntry</b>	M	N-Acc
docslfCmtsModIndex	M	N-Acc
docslfCmtsModIntervalUsageCode	M	N-Acc
docslfCmtsModControl	M	RC
docslfCmtsModType	M	RC
docslfCmtsModPreambleLen	M	RC
docslfCmtsModDifferentialEncoding	M	RC
docslfCmtsModFECErrorCorrection	M	RC
docslfCmtsModFECCodeWordLength	M	RC

docslfCmtsModScramblerSeed	M	RC
docslfCmtsModMaxBurstSize	M	RC
docslfCmtsModGuardTimeSize	M	RO
docslfCmtsModLastCodewordShortened	M	RC
docslfCmtsModScrambler	M	RC
docslfCmtsModByteInterleaverDepth	M	RC
docslfCmtsModByteInterleaverBlockSize	M	RC
docslfCmtsModPreambleType	M	RC
docslfCmtsModTcmErrorCorrectionOn	M	RC
docslfCmtsModScdmaInterleaverStepSize	M	RC
docslfCmtsModScdmaSpreaderEnable	M	RO
docslfCmtsModScdmaSubframeCodes	M	RC
docslfCmtsModChannelType	M	RC
docslfCmtsModStorageType	M	RC
<b>Object</b>	<b>CMTS</b>	<b>Access</b>
docslfCmtsQosProfilePermissions	M	RW /RO
<b>docslfCmtsMacToCmTable</b>	M	N-Acc
<b>docslfCmtsMacToCmEntry</b>	M	N-Acc
docslfCmtsCmMac	M	N-Acc
docslfCmtsCmPtr	M	RO
<b>Object</b>	<b>CMTS</b>	<b>Access</b>
docslfCmtsChannelUtilizationInterval	M	RW
<b>DocslfCmtsChannelUtilizationTable</b>	M	N-Acc
<b>DocslfCmtsChannelUtilizationEntry</b>	M	N-Acc
docslfCmtsChannelUtilType	M	N-Acc
docslfCmtsChannelUtilId	M	N-Acc
docslfCmtsChannelUtilization	M	RO
<b>docslfCmtsDownChannelCounterTable</b>	M	N-Acc
<b>docslfCmtsDownChannelCounterEntry</b>	M	N-Acc
docslfCmtsDownChnlCtrlId	M	RO
docslfCmtsDownChnlCtrTotalBytes	M	RO
docslfCmtsDownChnlCtrUsedBytes	M	RO
docslfCmtsDownChnlCtrExtTotalBytes	M	RO
docslfCmtsDownChnlCtrExtUsedBytes	M	RO
<b>docslfCmtsUpChannelCounterTable</b>	M	N-Acc
<b>docslfCmtsUpChannelCounterEntry</b>	M	N-Acc
docslfCmtsUpChnlCtrlId	M	RO
docslfCmtsUpChnlCtrTotalMslots	M	RO
docslfCmtsUpChnlCtrUcastGrantedMslots	M	RO
docslfCmtsUpChnlCtrTotalCntrMslots	M	RO
docslfCmtsUpChnlCtrUsedCntrMslots	M	RO
docslfCmtsUpChnlCtrExtTotalMslots	M	RO
docslfCmtsUpChnlCtrExtUcastGrantedMslots	M	RO
docslfCmtsUpChnlCtrExtTotalCntrMslots	M	RO

docslfCmtsUpChnlCtrExtUsedCntnMslots	M	RO
docslfCmtsUpChnlCtrCollCntnMslots	M	RO
docslfCmtsUpChnlCtrTotalCntnReqMslots	M	RO
docslfCmtsUpChnlCtrUsedCntnReqMslots	M	RO
docslfCmtsUpChnlCtrCollCntnReqMslots	M	RO
docslfCmtsUpChnlCtrTotalCntnReqDataMslots	M	RO
docslfCmtsUpChnlCtrUsedCntnReqDataMslots	M	RO
docslfCmtsUpChnlCtrCollCntnReqDataMslots	M	RO
docslfCmtsUpChnlCtrTotalCntnInitMaintMslots	M	RO
docslfCmtsUpChnlCtrUsedCntnInitMaintMslots	M	RO
docslfCmtsUpChnlCtrCollCntnInitMaintMslots	M	RO
docslfCmtsUpChnlCtrExtCollCntnMslots	M	RO
docslfCmtsUpChnlCtrExtTotalCntnReqMslots	M	RO
docslfCmtsUpChnlCtrExtUsedCntnReqMslots	M	RO
docslfCmtsUpChnlCtrExtCollCntnReqMslots	M	RO
docslfCmtsUpChnlCtrExtTotalCntnReqDataMslots	M	RO
docslfCmtsUpChnlCtrExtUsedCntnReqDataMslots	M	RO
docslfCmtsUpChnlCtrExtCollCntnReqDataMslots	M	RO
docslfCmtsUpChnlCtrExtTotalCntnInitMaintMslots	M	RO
docslfCmtsUpChnlCtrExtUsedCntnInitMaintMslots	M	RO
docslfCmtsUpChnlCtrExtCollCntnInitMaintMslots	M	RO
<b>DOCS-IF31-MIB</b>		
<b>Object</b>	<b>CMTS</b>	<b>Access</b>
<b>docslf31DocsisBaseCapability</b>	M	RO
<b>docslf31RxChStatusTable</b>	M	N-Acc
<b>docslf31RxChStatusEntry</b>	M	N-Acc
docslf31RxChStatusPrimaryDsIndicator	M	RO
docslf31RxChStatusOfdmProfiles	M	RO
<b>docslf31CmtsCmRegStatusTable</b>	M	N-Acc
<b>docslf31CmtsCmRegStatusEntry</b>	M	N-Acc
docslf31CmtsCmRegStatusAssignedEmlDs	M	RO
docslf31CmtsCmRegStatusDsProfileIdList	M	RO
docslf31CmtsCmRegStatusUsProfileLucList	M	RO
docslf31CmtsCmRegStatusTcsPhigh	M	RO
docslf31CmtsCmRegStatusTcsDrwTop	M	RO
docslf31CmtsCmRegStatusMinUsableDsFreq	M	RO
docslf31CmtsCmRegStatusMaxUsableDsFreq	M	RO
docslf31CmtsCmRegStatusMaxUsableUsFreq	M	RO
docslf31CmtsCmRegStatusPartialSvcState	M	RO
docslf31CmtsCmRegStatusPartialChanState	M	RO
<b>docslf31CmtsCmUsOfdmaChannelStatusTable</b>	M	N-Acc
<b>docslf31CmtsCmUsOfdmaChannelStatusEntry</b>	M	N-Acc
docslf31CmtsCmUsOfdmaChannelRxPower	M	RO
docslf31CmtsCmUsOfdmaChannelMeanRxMer	M	RO

docslf31CmtsCmUsOfdmaChannelStdDevRxMer	M	RO
docslf31CmtsCmUsOfdmaChannelRxMerThreshold	M	RW
docslf31CmtsCmUsOfdmaChannelThresholdRxMerValue	M	RO
docslf31CmtsCmUsOfdmaChannelThresholdRxMerHighest Freq	M	RO
docslf31CmtsCmUsOfdmaChannelMicroreflections	M	RO
docslf31CmtsCmUsOfdmaChannelHighResolutionTimingOffset	M	RO
docslf31CmtsCmUsOfdmaChannelsMuted	M	RO
docslf31CmtsCmUsOfdmaChannelRangingStatus	M	RO
docslf31CmtsCmUsOfdmaChannelCurPartialSvcReasonCode	M	RO
docslf31CmtsCmUsOfdmaChannelLastPartialSvcTime	M	RO
docslf31CmtsCmUsOfdmaChannelLastPartialSvcReasonCode	M	RO
docslf31CmtsCmUsOfdmaChannelNumPartialSvcIncidents	M	RO
docslf31CmtsCmUsOfdmaChannelNumPartialChanIncidents	M	RO
<b>docslf31CmtsCmUsOfdmaProfileStatusTable</b>	M	N-Acc
<b>docslf31CmtsCmUsOfdmaProfileStatusEntry</b>	M	N-Acc
docslf31CmtsCmUsOfdmaProfileTotalCodewords	M	RO
docslf31CmtsCmUsOfdmaProfileCorrectedCodewords	M	RO
docslf31CmtsCmUsOfdmaProfileUnreliableCodewords	M	RO
<b>docslf31CmtsCmDsOfdmChannelStatusTable</b>	M	N-Acc
<b>docslf31CmtsCmDsOfdmChannelStatusEntry</b>	M	N-Acc
docslf31CmtsCmDsOfdmChannelCurPartialSvcReasonCode	M	RO
docslf31CmtsCmDsOfdmChannelLastPartialSvcTime	M	RO
docslf31CmtsCmDsOfdmChannelLastPartialSvcReasonCode	M	RO
docslf31CmtsCmDsOfdmChannelNumPartialSvcIncidents	M	RO
docslf31CmtsCmDsOfdmChannelNumPartialChanIncidents	M	RO
<b>docslf31CmtsCmDsOfdmProfileStatusTable</b>	M	N-Acc
<b>docslf31CmtsCmDsOfdmProfileStatusEntry</b>	M	N-Acc
docslf31CmtsCmDsOfdmProfilePartialChanReasonCode	M	RO
docslf31CmtsCmDsOfdmProfileLastPartialChanTime	M	RO
docslf31CmtsCmDsOfdmProfileLastPartialChanReasonCode	M	RO
<b>docslf31CmtsCmEmStatsTable</b>	M	N-Acc
<b>docslf31CmtsCmEmStatsEntry</b>	M	N-Acc
docslf31CmtsCmEmStatsEm1x1ModeTotalDuration	M	RO
docslf31CmtsCmEmStatsDlsModeTotalDuration	M	RO
docslf31CmtsCmEmStatsLastDlsTime	M	RO
docslf31CmtsCmEmStatsDlsWakeupEvents	M	RO
<b>docslf31CmtsDsOfdmChanTable</b>	M	N-Acc
<b>docslf31CmtsDsOfdmChanEntry</b>	M	N-Acc
docslf31CmtsDsOfdmChanChannelId	M	RO

docslf31CmtsDsOfdmChanLowerBdryFreq	M	RO
docslf31CmtsDsOfdmChanUpperBdryFreq	M	RO
docslf31CmtsDsOfdmChanLowerBdryEncompSpectrum	M	RO
docslf31CmtsDsOfdmChanUpperBdryEncompSpectrum	M	RO
docslf31CmtsDsOfdmChanPlcFreq	M	RO
docslf31CmtsDsOfdmChanSubcarrierZeroFreq	M	RO
docslf31CmtsDsOfdmChanFirstActiveSubcarrierNum	M	RO
docslf31CmtsDsOfdmChanLastActiveSubcarrierNum	M	RO
docslf31CmtsDsOfdmChanNumActiveSubcarriers	M	RO
docslf31CmtsDsOfdmChanSubcarrierSpacing	M	RO
docslf31CmtsDsOfdmChanLowerGuardbandWidth	M	RO
docslf31CmtsDsOfdmChanUpperGuardbandWidth	M	RO
docslf31CmtsDsOfdmChanCyclicPrefix	M	RO
docslf31CmtsDsOfdmChanRollOffPeriod	M	RO
docslf31CmtsDsOfdmChanTimeInterleaverDepth	M	RO
docslf31CmtsDsOfdmChanNumPilots	M	RO
docslf31CmtsDsOfdmChanPilotScaleFactor	M	RO
docslf31CmtsDsOfdmChanNcpModulation	M	RO
docslf31CmtsDsOfdmChanUtilization	M	RO
<b>docslf31CmtsDsOfdmSubcarrierTypeTable</b>	M	N-Acc
<b>docslf31CmtsDsOfdmSubcarrierTypeEntry</b>	M	N-Acc
docslf31CmtsDsOfdmSubcarrierTypeStartSubcarrierId	M	RO
docslf31CmtsDsOfdmSubcarrierTypeEndSubcarrierId	M	RO
docslf31CmtsDsOfdmSubcarrierTypeSubcarrierType	M	RO
<b>docslf31CmtsDsOfdmProfileStatsTable</b>	M	N-Acc
<b>docslf31CmtsDsOfdmProfileStatsEntry</b>	M	N-Acc
docslf31CmtsDsOfdmProfileStatsProfileId	M	N-Acc
docslf31CmtsDsOfdmProfileStatsConfigChangeCt	M	RO
docslf31CmtsDsOfdmProfileStatsFullChannelSpeed	M	RO
docslf31CmtsDsOfdmProfileStatsOutOctets	M	RO
docslf31CmtsDsOfdmProfileStatsOutUnicastOctets	M	RO
docslf31CmtsDsOfdmProfileStatsOutMulticastOctets	M	RO
docslf31CmtsDsOfdmProfileStatsOutFrames	M	RO
docslf31CmtsDsOfdmProfileStatsOutUnicastFrames	M	RO
docslf31CmtsDsOfdmProfileStatsOutMulticastFrames	M	RO
docslf31CmtsDsOfdmProfileStatsCtrDiscontinuityTime	M	RO
docslf31CmtsDsOfdmProfileStatsAssignedCmCt	M	RO
<b>docslf31CmtsDsOfdmSubcarrierStatusTable</b>	M	N-Acc
<b>docslf31CmtsDsOfdmSubcarrierStatusEntry</b>	M	N-Acc
docslf31CmtsDsOfdmSubcarrierStatusStartId	M	N-Acc
docslf31CmtsDsOfdmSubcarrierStatusEndId	M	RO
docslf31CmtsDsOfdmSubcarrierStatusMainModulation	M	RO
docslf31CmtsDsOfdmSubcarrierStatusSkip	M	RO
docslf31CmtsDsOfdmSubcarrierStatusSkipModulation	M	RO

<b>docslf31CmtsDsOfdmChanPowerTable</b>	M	N-Acc
<b>docslf31CmtsDsOfdmChanPowerEntry</b>	M	N-Acc
docslf31CmtsDsOfdmChanPowerBandIndex	M	N-Acc
docslf31CmtsDsOfdmChanPowerCenterFrequency	M	RO
docslf31CmtsDsOfdmChanPowerTxPower	M	RO
<b>docslf31CmtsUsOfdmaChanTable</b>	M	N-Acc
<b>docslf31CmtsUsOfdmaChanEntry</b>	M	N-Acc
docslf31CmtsUsOfdmaChanTemplateIndex	M	RO
docslf31CmtsUsOfdmaChanConfigChangeCt	M	RO
docslf31CmtsUsOfdmaChanTargetRxPower	M	RO
docslf31CmtsUsOfdmaChanLowerBdryFreq	M	RO
docslf31CmtsUsOfdmaChanUpperBdryFreq	M	RO
docslf31CmtsUsOfdmaChanSubcarrierSpacing	M	RO
docslf31CmtsUsOfdmaChanCyclicPrefix	M	RO
docslf31CmtsUsOfdmaChanNumSymbolsPerFrame	M	RO
docslf31CmtsUsOfdmaChanRollOffPeriod	M	RO
docslf31CmtsUsOfdmaChanPreEqEnable	M	RO
docslf31CmtsUsOfdmaChanFineRngGuardband	M	RO
docslf31CmtsUsOfdmaChanFineRngNumSubcarriers	M	RO
docslf31CmtsUsOfdmaChanFineRngPreambleLen	M	RO
docslf31CmtsUsOfdmaChanInitRngGuardband	M	RO
docslf31CmtsUsOfdmaChanInitRngNumSubcarriers	M	RO
docslf31CmtsUsOfdmaChanInitRngPreambleLen	M	RO
docslf31CmtsUsOfdmaChanProvAttribMask	M	RO
docslf31CmtsUsOfdmaChanTxBackoffStart	M	RO
docslf31CmtsUsOfdmaChanTxBackoffEnd	M	RO
docslf31CmtsUsOfdmaChanRangingBackoffStart	M	RO
docslf31CmtsUsOfdmaChanRangingBackoffEnd	M	RO
docslf31CmtsUsOfdmaChanUtilization	M	RO
docslf31CmtsUsOfdmaChanId	M	RO
<b>docslf31CmtsUsOfdmaSubcarrierTypeTable</b>	M	N-Acc
<b>docslf31CmtsUsOfdmaSubcarrierTypeEntry</b>	M	N-Acc
docslf31CmtsUsOfdmaSubcarrierTypeStartSubcarrierId	M	RO
docslf31CmtsUsOfdmaSubcarrierTypeEndSubcarrierId	M	RO
docslf31CmtsUsOfdmaSubcarrierTypeSubcarrierType	M	RO
<b>docslf31CmtsUsOfdmaDatalucStatsTable</b>	M	N-Acc
<b>docslf31CmtsUsOfdmaDatalucStatsEntry</b>	M	N-Acc
docslf31CmtsUsOfdmaDatalucStatsDataluc	M	N-Acc
docslf31CmtsUsOfdmaDatalucStatsMinislotPilotPattern	M	RO
docslf31CmtsUsOfdmaDatalucStatsMinislotModulation	M	RO
docslf31CmtsUsOfdmaDatalucStatsTotalCodewords	M	RO
docslf31CmtsUsOfdmaDatalucStatsCorrectedCodewords	M	RO
docslf31CmtsUsOfdmaDatalucStatsUnreliableCodewords	M	RO
docslf31CmtsUsOfdmaDatalucStatsInOctets	M	RO

docsIf31CmtsUsOfdmaDataLucStatsCtrDiscontinuityTime	M	RO
docsIf31CmtsUsOfdmaDataLucStatsAssignedCmCt	M	RO
<b>docsIf31CmtsUsOfdmaDataLucDetailStatusTable</b>	M	N-Acc
<b>docsIf31CmtsUsOfdmaDataLucDetailStatusEntry</b>	M	N-Acc
docsIf31CmtsUsOfdmaDataLucDetailStatusLowerFreq	M	N-Acc
docsIf31CmtsUsOfdmaDataLucDetailStatusUpperFreq	M	RO
docsIf31CmtsUsOfdmaDataLucDetailStatusMinislotPilotPattern	M	RO
docsIf31CmtsUsOfdmaDataLucDetailStatusMinislotModulation	M	RO
<b>docsIf31CmtsUsOfdmaRangingLucStatusTable</b>	M	N-Acc
<b>docsIf31CmtsUsOfdmaRangingLucStatusEntry</b>	M	N-Acc
docsIf31CmtsUsOfdmaRangingLucStatusLuc	M	N-Acc
docsIf31CmtsUsOfdmaRangingLucStatusGuardband	M	RO
docsIf31CmtsUsOfdmaRangingLucStatusNumSubcarriers	M	RO
<b>DOCS-DRF-MIB [M-OSSI]</b>		
<b>Object</b>	<b>CMTS</b>	<b>Access</b>
<b>docsDrfDownstreamTable</b>	M	N-Acc
<b>docsDrfDownstreamEntry</b>	M	N-Acc
docsDrfDownstreamPhyDependencies	M	RO
<b>docsDrfDownstreamCapabilitiesTable</b>	M	N-Acc
<b>docsDrfDownstreamCapabilitiesEntry</b>	M	N-Acc
docsDrfDownstreamCapabFrequency	M	RO
docsDrfDownstreamCapabBandwidth	M	RO
docsDrfDownstreamCapabPower	M	RO
docsDrfDownstreamCapabModulation	M	RO
docsDrfDownstreamCapabInterleaver	M	RO
docsDrfDownstreamCapabJ83Annex	M	RO
docsDrfDownstreamCapabConcurrentServices	NA	
docsDrfDownstreamCapabServicesTransport	NA	
docsDrfDownstreamCapabMuting	M	RO
<b>docsDrfGroupDependencyTable</b>	M	N-Acc
<b>docsDrfGroupDependencyEntry</b>	M	N-Acc
docsDrfGroupDependencyPhyParam	M	N-Acc
docsDrfGroupDependencyPhysicalIndex	M	N-Acc
docsDrfGroupDependencyGroupID	O	RO
docsDrfGroupDependencyType	M	RO
<b>docsDrfChannelBlockTable</b>	M	N-Acc
<b>docsDrfChannelBlockEntry</b>	M	N-Acc
docsDrfChannelBlockPhysicalIndex	M	N-Acc
docsDrfChannelBlockNumberChannels	M	RO
docsDrfChannelBlockCfgNumberChannels	M	RW
docsDrfChannelBlockMute	M	RW
docsDrfChannelBlockTestType	M	RW
docsDrfChannelBlockTestIndex	M	RW

<b>IF-MIB [RFC 2863]</b>		
<b>Object</b>	<b>CMTS</b>	<b>Access</b>
ifNumber	M	RO
ifTableLastChange	M	RO
<b>ifTable</b> Note: The ifTable Counter32 objects are not reflected here; refer to Table 7-12 for details on these objects.	M	N-Acc
<b>ifEntry</b>	M	N-Acc
ifIndex	M	RO
ifDescr	M	RO
ifType	M	RO
ifMtu	M	RO
ifSpeed	M	RO
ifPhysAddress	M	RO
ifAdminStatus	M	RW
ifOperStatus	M	RO
ifLastChange	M	RO
ifOutQLen	D	RO
ifSpecific	D	RO
<b>ifXTable</b> Note: The ifXTable Counter32 and Counter64 objects are not reflected here; refer to Table 7-12 for details on these objects.	M	N-Acc
<b>ifXEntry</b>	M	N-Acc
ifName	M	RO
ifLinkUpDownTrapEnable	M	RW
ifHighSpeed	M	RO
ifPromiscuousMode	M	RW/RO
ifConnectorPresent	M	RO
ifAlias	M	RW/RO
ifCounterDiscontinuityTime	M	RO
<b>ifStackTable</b>	M	N-Acc
<b>ifStackEntry</b>	M	N-Acc
ifStackHigherLayer	M	N-Acc
ifStackLowerLayer	M	N-Acc
ifStackStatus	M	RC/RO
<b>Object</b>	<b>CMTS</b>	<b>Access</b>
ifStackLastChange	M	RC/RO
<b>ifRcvAddressTable</b>	O	N-Acc
<b>ifRcvAddressEntry</b>	O	N-Acc
ifRcvAddressAddress	O	N-Acc
ifRcvAddressStatus	O	RC
IfRcvAddressType	O	RC
<b>Notification</b>		
linkUp	M	Acc-FN
linkDown	M	Acc-FN



<b>ifTestTable</b>	D	N-Acc
<b>ifTestEntry</b>	D	N-Acc
ifTestId	D	RW
ifTestStatus	D	RW
ifTestType	D	RW
ifTestResult	D	RO
ifTestCode	D	RO
ifTestOwner	D	RW
<b>BRIDGE-MIB [RFC 4188]</b>		
<b>Note: Implementation of BRIDGE-MIB is required ONLY if device is a bridging device.</b>		
<b>Object</b>	<b>CMTS</b>	<b>Access</b>
<b>dot1dBase</b>		
dot1dBaseBridgeAddress	M	RO
dot1dBaseNumPorts	M	RO
dot1dBaseType	M	RO
<b>dot1dBasePortTable</b>	M	N-Acc
<b>dot1dBasePortEntry</b>	M	N-Acc
dot1dBasePort	M	RO
dot1dBasePortIfIndex	M	RO
dot1dBasePortCircuit	M	RO
dot1dBasePortDelayExceededDiscards	M	RO
dot1dBasePortMtuExceededDiscards	M	RO
<b>dot1dStp</b>		
dot1dStpProtocolSpecification	M	RO
dot1dStpPriority	M	RW
dot1dStpTimeSinceTopologyChange	M	RO
dot1dStpTopChanges	M	RO
dot1dStpDesignatedRoot	M	RO
dot1dStpRootCost	M	RO
dot1dStpRootPort	M	RO
dot1dStpMaxAge	M	RO
dot1dStpHelloTime	M	RO
dot1dStpHoldTime	M	RO
dot1dStpForwardDelay	M	RO
dot1dStpBridgeMaxAge	M	RW
dot1dStpBridgeHelloTime	M	RW
dot1dStpBridgeForwardDelay	M	RW
<b>dot1dStpPortTable</b>	O	N-Acc
<b>Note: This table is required ONLY if STP is implemented.</b>		
<b>dot1dStpPortEntry</b>	O	N-Acc
dot1dStpPort	O	RO
dot1dStpPortPriority	O	RW
dot1dStpPortState	O	RO
dot1dStpPortEnable	O	RW

dot1dStpPortPathCost	O	RW
dot1dStpPortDesignatedRoot	O	RO
dot1dStpPortDesignatedCost	O	RO
dot1dStpPortDesignatedBridge	O	RO
dot1dStpPortDesignatedPort	O	RO
dot1dStpPortForwardTransitions	O	RO
dot1dStpPortPathCost32	O	RO
<b>dot1dTp</b> <b>Note: This group is required ONLY if transparent bridging is implemented.</b>		
dot1dTpLearnedEntryDiscards	M	RO
dot1dTpAgingTime	M	RW
<b>dot1dTpFdbTable</b>	M	N-Acc
<b>dot1dTpFdbEntry</b>	M	N-Acc
dot1dTpFdbAddress	M	RO
dot1dTpFdbPort	M	RO
dot1dTpFdbStatus	M	RO
<b>dot1dTpPortTable</b>	M	N-Acc
<b>dot1dTpPortEntry</b>	M	N-Acc
dot1dTpPort	M	RO
dot1dTpPortMaxInfo	M	RO
dot1dTpPortInFrames	M	RO
dot1dTpPortOutFrames	M	RO
dot1dTpPortInDiscards	M	RO
<b>dot1dStaticTable</b> <b>Note: Implementation of dot1dStaticTable is OPTIONAL.</b>	O	N-Acc
<b>dot1dStaticEntry</b>	O	N-Acc
dot1dStaticAddress	O	RW
dot1dStaticReceivePort	O	RW
dot1dStaticAllowedToGoTo	O	RW
dot1dStaticStatus	O	RW
<b>Notification</b>		
newRoot	O	Acc-FN
topologyChange	O	Acc-FN
<b>DOCS-CABLE-DEVICE-MIB [RFC 2669]</b>		
<b>Object</b>	<b>CMTS</b>	<b>Access</b>
<b>docsDevBase</b>		
docsDevRole	O	RO
docsDevDateTime	M	RW
docsDevResetNow	O	RW
docsDevSerialNumber	O	RO
docsDevSTPControl	O	RW/RO
<b>Object</b>	<b>CMTS</b>	<b>Access</b>
<b>docsDevNmAccessTable</b>	O	N-Acc
<b>docsDevNmAccessEntry</b>	O	N-Acc

docsDevNmAccessIndex	O	N-Acc
docsDevNmAccessIp	O	RC
docsDevNmAccessIpMask	O	RC
docsDevNmAccessCommunity	O	RC
docsDevNmAccessControl	O	RC
docsDevNmAccessInterfaces	O	RC
docsDevNmAccessStatus	O	RC
docsDevNmAccessTrapVersion	O	RC
<b>Object</b>	<b>CMTS</b>	<b>Access</b>
<b>docsDevSoftware</b>		
docsDevSwServer	D	RW
docsDevSwFilename	O	RW
docsDevSwAdminStatus	O	RW
docsDevSwOperStatus	O	RO
docsDevSwCurrentVers	O	RO
docsDevSwServerAddressType	O	RO
docsDevSwServerAddress	O	RO
docsDevSwServerTransportProtocol	O	RO
<b>docsDevEvent</b>		
docsDevEvControl	M	RW
docsDevEvSyslog	D	RW
docsDevEvThrottleAdminStatus	M	RW
docsDevEvThrottleInhibited	D	RO
docsDevEvThrottleThreshold	M	RW
docsDevEvThrottleInterval	M	RW
<b>docsDevEvControlTable</b>	M	N-Acc
<b>docsDevEvControlEntry</b>	M	N-Acc
docsDevEvPriority	M	N-Acc
docsDevEvReporting	M	RW
<b>docsDevEventTable</b>	M	N-Acc
<b>docsDevEventEntry</b>	M	N-Acc
docsDevEvIndex	M	N-Acc
docsDevEvFirstTime	M	RO
docsDevEvLastTime	M	RO
docsDevEvCounts	M	RO
docsDevEvLevel	M	RO
docsDevEvId	M	RO
docsDevEvText	M	RO
docsDevEvSyslogAddressType	M	RW
docsDevEvSyslogAddress	M	RW
docsDevEvThrottleThresholdExceeded	M	RO
<b>docsDevFilter</b>		
docsDevFilterLLCUnmatchedAction	O	RW
<b>docsDevFilterLLCTable</b>	O	N-Acc

<b>docsDevFilterLLCEntry</b>	O	N-Acc
docsDevFilterLLCIndex	O	N-Acc
docsDevFilterLLCStatus	O	RC
docsDevFilterLLCIfIndex	O	RC
docsDevFilterLLCProtocolType	O	RC
docsDevFilterLLCProtocol	O	RC
docsDevFilterLLCMatches	O	RO
Object	<b>CMTS</b>	<b>Access</b>
docsDevFilterIpDefault	O	RW
<b>docsDevFilterIpTable</b>	D	N-Acc
<b>docsDevFilterIpEntry</b>	D	N-Acc
docsDevFilterIpIndex	D	N-Acc
docsDevFilterIpStatus	D	RC
docsDevFilterIpControl	D	RC
docsDevFilterIpIffIndex	D	RC
docsDevFilterIpDirection	D	RC
docsDevFilterIpBroadcast	D	RC
docsDevFilterIpSaddr	D	RC
docsDevFilterIpSmask	D	RC
docsDevFilterIpDaddr	D	RC
docsDevFilterIpDmask	D	RC
docsDevFilterIpProtocol	D	RC
docsDevFilterIpSourcePortLow	D	RC
docsDevFilterIpSourcePortHigh	D	RC
docsDevFilterIpDestPortLow	D	RC
docsDevFilterIpDestPortHigh	D	RC
docsDevFilterIpMatches	D	RO
docsDevFilterIpTos	D	RC
docsDevFilterIpTosMask	D	RC
docsDevFilterIpContinue	D	RC
docsDevFilterIpPolicyId	D	RC
<b>docsDevFilterPolicyTable</b>	D	N-Acc
<b>docsDevFilterPolicyEntry</b>	D	N-Acc
docsDevFilterPolicyIndex	D	N-Acc
docsDevFilterPolicyId	D	RC
docsDevFilterPolicyStatus	D	RC
docsDevFilterPolicyPtr	D	RC
<b>docsDevFilterTosTable</b>	D	N-Acc
<b>docsDevFilterTosEntry</b>	D	N-Acc
docsDevFilterTosIndex	D	N-Acc
docsDevFilterTosStatus	D	RC
docsDevFilterTosAndMask	D	RC
docsDevFilterTosOrMask	D	RC
<b>IP-MIB [RFC 4293]</b>		

Object	CMTS	Access
<b>ipv4GeneralGroup</b>		
ipForwarding	M	RW
ipDefaultTTL	M	RW
ipReasmTimeout	M	RW
<b>ipv6GeneralGroup2</b>		
ipv6IpForwarding	M	RW
ipv6IpDefaultHopLimit	M	RW
ipv4InterfaceTableLastChange	M	RO
<b>ipv4InterfaceTable</b>	M	N-Acc
<b>ipv4InterfaceEntry</b>	M	N-Acc
ipv4InterfaceIfIndex	M	N-Acc
ipv4InterfaceReasmMaxSize	M	RO
ipv4InterfaceEnableStatus	M	RW
ipv4InterfaceRetransmitTime	M	RO
<b>Object</b>	<b>CMTS</b>	<b>Access</b>
ipv6InterfaceTableLastChange	M	RO
<b>ipv6InterfaceTable</b>	M	N-Acc
<b>ipv6InterfaceEntry</b>	M	N-Acc
ipv6InterfaceIfIndex	M	N-Acc
ipv6InterfaceReasmMaxSize	M	RO
ipv6InterfaceIdentifier	M	RO
ipv6InterfaceEnableStatus	M	RW
ipv6InterfaceReachableTime	M	RO
ipv6InterfaceRetransmitTime	M	RO
ipv6InterfaceForwarding	M	RW
<b>ipSystemStatsTable</b>	O	N-Acc
<b>ipSystemStatsEntry</b>	O	N-Acc
ipSystemStatsIPVersion	O	N-Acc
ipSystemStatsInReceives	O	RO
ipSystemStatsHCInReceives	O	RO
ipSystemStatsInOctets	O	RO
ipSystemStatsHCInOctets	O	RO
ipSystemStatsInHdrErrors	O	RO
ipSystemStatsInNoRoutes	O	RO
ipSystemStatsInAddrErrors	O	RO
ipSystemStatsInUnknownProtos	O	RO
ipSystemStatsInTruncatedPkts	O	RO
ipSystemStatsInForwDatagrams	O	RO
ipSystemStatsHCInForwDatagrams	O	RO
ipSystemStatsReasmReqds	O	RO
ipSystemStatsReasmOKs	O	RO
ipSystemStatsReasmFails	O	RO
ipSystemStatsInDiscards	O	RO

ipSystemStatsInDelivers	O	RO
ipSystemStatsHCInDelivers	O	RO
ipSystemStatsOutRequests	O	RO
ipSystemStatsHCOutRequests	O	RO
ipSystemStatsOutNoRoutes	O	RO
ipSystemStatsOutForwDatagrams	O	RO
ipSystemStatsHCOutForwDatagrams	O	RO
ipSystemStatsOutDiscards	O	RO
ipSystemStatsOutFragReqds	O	RO
ipSystemStatsOutFragOKs	O	RO
ipSystemStatsOutFragFails	O	RO
ipSystemStatsOutFragCreates	O	RO
ipSystemStatsOutTransmits	O	RO
ipSystemStatsHCOutTransmits	O	RO
ipSystemStatsOutOctets	O	RO
ipSystemStatsHCOutOctets	O	RO
ipSystemStatsInMcastPkts	O	RO
ipSystemStatsHCInMcastPkts	O	RO
ipSystemStatsInMcastOctets	O	RO
ipSystemStatsHCInMcastOctets	O	RO
ipSystemStatsOutMcastPkts	O	RO
ipSystemStatsHCOutMcastPkts	O	RO
ipSystemStatsOutMcastOctets	O	RO
ipSystemStatsHCOutMcastOctets	O	RO
ipSystemStatsInBcastPkts	O	RO
ipSystemStatsHCInBcastPkts	O	RO
ipSystemStatsOutBcastPkts	O	RO
ipSystemStatsHCOutBcastPkts	O	RO
ipSystemStatsDiscontinuityTime	O	RO
ipSystemStatsRefreshRate	O	RO
<b>Object</b>	<b>CMTS</b>	<b>Access</b>
ipIfStatsTableLastChange	O	RO
<b>ipIfStatsTable</b> <b>Note: This table is required ONLY if routing is implemented.</b>	M	N-Acc
<b>ipIfStatsEntry</b>	M	N-Acc
ipIfStatsIPVersion	M	N-Acc
ipIfStatsIfIndex	M	N-Acc
ipIfStatsInReceives	M	RO
ipIfStatsHCInReceives	M	RO
ipIfStatsInOctets	M	RO
ipIfStatsHCInOctets	M	RO
ipIfStatsInHdrErrors	M	RO
ipIfStatsInNoRoutes	M	RO
ipIfStatsInAddrErrors	M	RO

ipLfStatsInUnknownProtos	M	RO
ipLfStatsInTruncatedPkts	M	RO
ipLfStatsInForwDatagrams	M	RO
ipLfStatsHCInForwDatagrams	M	RO
ipLfStatsReasmReqds	M	RO
ipLfStatsReasmOKs	M	RO
ipLfStatsReasmFails	M	RO
ipLfStatsInDiscards	M	RO
ipLfStatsInDelivers	M	RO
ipLfStatsHCInDelivers	M	RO
ipLfStatsOutRequests	M	RO
ipLfStatsHCOutRequests	M	RO
ipLfStatsOutForwDatagrams	M	RO
ipLfStatsHCOutForwDatagrams	M	RO
ipLfStatsOutDiscards	M	RO
ipLfStatsOutFragReqds	M	RO
ipLfStatsOutFragOKs	M	RO
ipLfStatsOutFragFails	M	RO
ipLfStatsOutFragCreates	M	RO
ipLfStatsOutTransmits	M	RO
ipLfStatsHCOutTransmits	M	RO
ipLfStatsOutOctets	M	RO
ipLfStatsHCOutOctets	M	RO
ipLfStatsInMcastPkts	M	RO
ipLfStatsHCInMcastPkts	M	RO
ipLfStatsInMcastOctets	M	RO
ipLfStatsHCInMcastOctets	M	RO
ipLfStatsOutMcastPkts	M	RO
ipLfStatsHCOutMcastPkts	M	RO
ipLfStatsOutMcastOctets	M	RO
ipLfStatsHCOutMcastOctets	M	RO
ipLfStatsInBcastPkts	M	RO
ipLfStatsHCInBcastPkts	M	RO
ipLfStatsOutBcastPkts	M	RO
ipLfStatsHCOutBcastPkts	M	RO
ipLfStatsDiscontinuityTime	M	RO
ipLfStatsRefreshRate	M	RO
<b>ipAddressPrefixTable</b> <b>Note: This table is required ONLY if routing is implemented.</b>	M	N-Acc
<b>ipAddressPrefixEntry</b>	M	N-Acc
ipAddressPrefixIndex	M	N-Acc
ipAddressPrefixType	M	N-Acc
ipAddressPrefixPrefix	M	N-Acc
ipAddressPrefixLength	M	N-Acc

ipAddressPrefixOrigin	M	RO
ipAddressPrefixOnLinkFlag	M	RO
ipAddressPrefixAutonomousFlag	M	RO
ipAddressPrefixAdvPreferredLifetime	M	RO
ipAddressPrefixAdvValidLifetime	M	RO
<b>Object</b>	<b>CMTS</b>	<b>Access</b>
ipAddressSpinLock	M	RW
<b>ipAddressTable</b>	M	N-Acc
<b>ipAddressEntry</b>	M	N-Acc
ipAddressAddrType	M	N-Acc
ipAddressAddr	M	N-Acc
ipAddressIfIndex	M	RO
ipAddressType	M	RO
ipAddressPrefix	M	RO
ipAddressOrigin	M	RO
ipAddressStatus	M	RO
ipAddressCreated	M	RO
ipAddressLastChanged	M	RO
ipAddressRowStatus	M	RO
ipAddressStorageType	M	RO
<b>ipNetToPhysicalTable</b> <b>Note: This table is required ONLY if routing is implemented.</b>	M	N-Acc
<b>ipNetToPhysicalEntry</b>	M	N-Acc
ipNetToPhysicalIfIndex	M	N-Acc
ipNetToPhysicalNetAddressType	M	N-Acc
ipNetToPhysicalNetAddress	M	N-Acc
ipNetToPhysicalPhysAddress	M	RC
ipNetToPhysicalLastUpdated	M	RO
ipNetToPhysicalType	M	RC
ipNetToPhysicalState	M	RO
ipNetToPhysicalRowStatus	M	RC
<b>ipDefaultRouterTable</b> <b>Note: This table is required ONLY if routing is implemented.</b>	M	N-Acc
<b>ipDefaultRouterEntry</b>	M	N-Acc
ipDefaultRouterAddressType	M	N-Acc
ipDefaultRouterAddress	M	N-Acc
ipDefaultRouterIfIndex	M	N-Acc
ipDefaultRouterLifetime	M	RC
ipDefaultRouterPreference	M	RO
<b>ipv6RouterAdvertGroup</b>		
ipv6RouterAdvertSpinLock	O	RW
<b>ipv6RouterAdvertTable</b> <b>Note: This table is required ONLY if routing is implemented.</b>	M	N-Acc



<b>ipv6RouterAdvertEntry</b>	M	N-Acc
ipv6RouterAdvertIfIndex	M	N-Acc
ipv6RouterAdvertSendAdverts	M	RC
ipv6RouterAdvertMaxInterval	M	RC
ipv6RouterAdvertMinInterval	M	RC
ipv6RouterAdvertManagedFlag	M	RC
ipv6RouterAdvertOtherConfigFlag	M	RC
ipv6RouterAdvertLinkMTU	M	RC
ipv6RouterAdvertReachableTime	M	RC
ipv6RouterAdvertRetransmitTime	M	RC
ipv6RouterAdvertCurHopLimit	M	RC
ipv6RouterAdvertDefaultLifetime	M	RC
ipv6RouterAdvertRowStatus	M	RC
<b>icmpStatsTable</b>	M	N-Acc
<b>icmpStatsEntry</b>	M	N-Acc
icmpStatsIPVersion	M	N-Acc
icmpStatsInMsgs	M	RO
icmpStatsInErrors	M	RO
icmpStatsOutMsgs	M	RO
icmpStatsOutErrors	M	RO
<b>icmpMsgStatsTable</b>	M	N-Acc
<b>icmpMsgStatsEntry</b>	M	N-Acc
icmpMsgStatsIPVersion	M	N-Acc
icmpMsgStatsType	M	N-Acc
icmpMsgStatsInPkts	M	RO
icmpMsgStatsOutPkts	M	RO
<b>UDP-MIB [RFC 4113]</b>		
<b>Object</b>	<b>CMTS</b>	<b>Access</b>
<b>UDPGroup</b>		
udpInDatagrams	O	RO
udpNoPorts	O	RO
udpInErrors	O	RO
udpOutDatagrams	O	RO
<b>udpEndpointTable</b>	O	N-Acc
<b>udpEndpointEntry</b>	O	N-Acc
udpEndpointLocalAddressType	O	N-Acc
udpEndpointLocalAddress	O	N-Acc
udpEndpointLocalPort	O	N-Acc
udpEndpointRemoteAddressType	O	N-Acc
udpEndpointRemoteAddress	O	N-Acc
udpEndpointRemotePort	O	N-Acc
udpEndpointInstance	O	N-Acc
udpEndpointProcess	O	RO
<b>TCP-MIB [RFC 4022]</b>		

Object	CMTS	Access
<b>tcpBaseGroup</b>		
tcpRtoAlgorithm	O	RO
tcpRtoMin	O	RO
tcpRtoMax	O	RO
tcpMaxConn	O	RO
tcpActiveOpens	O	RO
tcpPassiveOpens	O	RO
tcpAttemptFails	O	RO
tcpEstabResets	O	RO
tcpCurrEstab	O	RO
tcpInSegs	O	RO
tcpOutSegs	O	RO
tcpRetransSegs	O	RO
tcpInErrs	O	RO
tcpOutRsts	O	RO
<b>tcpHCGroup</b>		
tcpHCInSegs	O	RO
tcpHCOutSegs	O	RO
<b>tcpConnectionTable</b>	O	N-Acc
<b>tcpConnectionEntry</b>	O	N-Acc
tcpConnectionLocalAddressType	O	N-Acc
tcpConnectionLocalAddress	O	N-Acc
tcpConnectionLocalPort	O	N-Acc
tcpConnectionRemAddressType	O	N-Acc
tcpConnectionRemAddress	O	N-Acc
tcpConnectionRemPort	O	N-Acc
tcpConnectionState	O	RW
tcpConnectionProcess	O	RO
<b>tcpListenerTable</b>	O	N-Acc
<b>tcpListenerEntry</b>	O	N-Acc
tcpListenerLocalAddressType	O	N-Acc
tcpListenerLocalAddress	O	N-Acc
tcpListenerLocalPort	O	N-Acc
tcpListenerProcess	O	RO
<b>SNMPv2-MIB [RFC 3418]</b>		
<b>Object</b>	<b>CMTS</b>	<b>Access</b>
<b>SystemGroup</b>		
sysDescr	M	RO
sysObjectID	M	RO
sysUpTime	M	RO
sysContact	M	RW
sysName	M	RW
sysLocation	M	RW

sysServices	M	RO
sysORLastChange	M	RO
<b>sysORTable</b>	M	N-Acc
<b>sysOREntry</b>	M	N-Acc
sysORIndex	M	N-Acc
sysORID	M	RO
sysORDescr	M	RO
sysORUpTime	M	RO
<b>SNMPGroup</b>		
snmplnPkts	M	RO
snmplnBadVersions	M	RO
snmpOutPkts	Ob	RO
snmplnBadCommunityNames	M	RO
snmplnBadCommunityUses	M	RO
snmplnASNParseErrs	M	RO
snmplnTooBig	Ob	RO
snmplnNoSuchNames	Ob	RO
snmplnBadValues	Ob	RO
snmplnReadOnly	Ob	RO
snmplnGenErrs	Ob	RO
snmplnTotalReqVars	Ob	RO
snmplnTotalSetVars	Ob	RO
snmplnGetRequests	Ob	RO
snmplnGetNexts	Ob	RO
snmplnSetRequests	Ob	RO
snmplnGetResponses	Ob	RO
snmplnTraps	Ob	RO
snmpOutTooBig	Ob	RO
snmpOutNoSuchNames	Ob	RO
snmpOutBadValues	Ob	RO
snmpOutGenErrs	Ob	RO
snmpOutGetRequests	Ob	RO
snmpOutGetNexts	Ob	RO
snmpOutSetRequests	Ob	RO
snmpOutGetResponses	Ob	RO
snmpOutTraps	Ob	RO
snmpEnableAuthenTraps	M	RW
snmpSilentDrops	M	RO
snmpProxyDrops	M	RO
<b>snmpTrapsGroup</b>		
coldStart	M	Acc-FN
warmStart	O	Acc-FN
authenticationFailure	M	Acc-FN
<b>snmpSetGroup</b>		

snmpSetSerialNo	M	RW
<b>Etherlike-MIB [RFC 3635]</b>		
<b>Object</b>	<b>CMTS</b>	<b>Access</b>
<b>dot3StatsTable</b>	M	N-Acc
<b>dot3StatsEntry</b>	M	N-Acc
dot3StatsIndex	M	RO
dot3StatsAlignmentErrors	M	RO
dot3StatsFCSErrors	M	RO
dot3StatsInternalMacTransmitErrors	M	RO
dot3StatsFrameTooLongs	M	RO
dot3StatsInternalMacReceiveErrors	M	RO
dot3StatsSymbolErrors	M	RO
dot3StatsSingleCollisionFrames	O	RO
dot3StatsMultipleCollisionFrames	O	RO
dot3StatsDeferredTransmissions	O	RO
dot3StatsLateCollisions	O	RO
dot3StatsExcessiveCollisions	O	RO
dot3StatsCarrierSenseErrors	O	RO
dot3StatsDuplexStatus	O	RO
dot3StatsSQETestErrors	N-Sup	
<b>dot3CollTable</b>	O	N-Acc
<b>dot3CollEntry</b>	O	N-Acc
dot3CollCount	O	NA
dot3CollFrequencies	O	RO
<b>dot3ControlTable</b>	O	N-Acc
<b>dot3ControlEntry</b>	O	N-Acc
dot3ControlFunctionsSupported	O	RO
dot3ControlInUnknownOpcodes	O	RO
<b>dot3PauseTable</b>	O	N-Acc
<b>dot3PauseEntry</b>	O	N-Acc
dot3PauseAdminMode	O	RW
dot3PauseOperMode	O	RO
dot3InPauseFrames	O	RO
dot3OutPauseFrames	O	RO
<b>DOCS-IETF-BPI2-MIB [RFC 4131]</b>		
<b>Object</b>	<b>CMTS</b>	<b>Access</b>
<b>docsBpi2CmtsBaseEntryTable</b>	M	N-Acc
<b>docsBpi2CmtsBaseEntryEntry</b>	M	N-Acc
docsBpi2CmtsDefaultAuthLifetime	M	RW
docsBpi2CmtsDefaultTEKLifetime	M	RW
docsBpi2CmtsDefaultSelfSignedManufCertTrust	M	RW
docsBpi2CmtsCheckCertValidityPeriods	M	RW
docsBpi2CmtsAuthentInfos	M	RO
docsBpi2CmtsAuthRequests	M	RO

docsBpi2CmtsAuthReplies	M	RO
docsBpi2CmtsAuthRejects	M	RO
docsBpi2CmtsAuthInvalids	M	RO
docsBpi2CmtsSAMapRequests	M	RO
docsBpi2CmtsSAMapReplies	M	RO
docsBpi2CmtsSAMapRejects	M	RO
<b>docsBpi2CmtsAuthEntryTable</b>	M	N-Acc
<b>docsBpi2CmtsAuthEntryEntry</b>	M	N-Acc
docsBpi2CmtsAuthCmMacAddress	M	N-Acc
docsBpi2CmtsAuthCmBpiVersion	M	RO
docsBpi2CmtsAuthCmPublicKey	M	RO
docsBpi2CmtsAuthCmKeySequenceNumber	M	RO
docsBpi2CmtsAuthCmExpiresOld	M	RO
docsBpi2CmtsAuthCmExpiresNew	M	RO
docsBpi2CmtsAuthCmLifetime	M	RW
docsBpi2CmtsAuthCmReset	M	RW
docsBpi2CmtsAuthCmInfos	M	RO
docsBpi2CmtsAuthCmRequests	M	RO
docsBpi2CmtsAuthCmReplies	M	RO
docsBpi2CmtsAuthCmRejects	M	RO
docsBpi2CmtsAuthCmInvalids	M	RO
docsBpi2CmtsAuthRejectErrorCode	M	RO
docsBpi2CmtsAuthRejectErrorString	M	RO
docsBpi2CmtsAuthInvalidErrorCode	M	RO
docsBpi2CmtsAuthInvalidErrorString	M	RO
docsBpi2CmtsAuthPrimarySAId	M	RO
docsBpi2CmtsAuthBpkmCmCertValid	M	RO
docsBpi2CmtsAuthBpkmCmCert	M	RO
docsBpi2CmtsAuthCACertIndexPtr	M	RO
<b>docsBpi2CmtsTEKTable</b>	M	N-Acc
<b>docsBpi2CmtsTEKEntry</b>	M	N-Acc
docsBpi2CmtsTEKSAId	M	N-Acc
docsBpi2CmtsTEKSAType	M	RO
docsBpi2CmtsTEKDataEncryptAlg	M	RO
docsBpi2CmtsTEKDataAuthentAlg	M	RO
docsBpi2CmtsTEKLifetime	M	RW
docsBpi2CmtsTEKKeySequenceNumber	M	RO
docsBpi2CmtsTEKExpiresOld	M	RO
docsBpi2CmtsTEKExpiresNew	M	RO
docsBpi2CmtsTEKReset	M	RW
docsBpi2CmtsKeyRequests	M	RO
docsBpi2CmtsKeyReplies	M	RO
docsBpi2CmtsKeyRejects	M	RO
docsBpi2CmtsTEKInvalids	M	RO

docsBpi2CmtsKeyRejectErrorCode	M	RO
docsBpi2CmtsKeyRejectErrorString	M	RO
docsBpi2CmtsTEKInvalidErrorCode	M	RO
docsBpi2CmtsTEKInvalidErrorString	M	RO
<b>docsBpi2CmtsIpMulticastMapTable</b>	M	N-Acc
<b>docsBpi2CmtsIpMulticastMapEntry</b>	M	N-Acc
docsBpi2CmtsIpMulticastIndex	M	N-Acc
docsBpi2CmtsIpMulticastAddressType	M	RO
docsBpi2CmtsIpMulticastAddress	M	RO
docsBpi2CmtsIpMulticastMask	M	RO
docsBpi2CmtsIpMulticastSAId	M	RO
docsBpi2CmtsIpMulticastSAType	M	RO
docsBpi2CmtsIpMulticastDataEncryptAlg	M	RO
docsBpi2CmtsIpMulticastDataAuthentAlg	M	RO
docsBpi2CmtsIpMulticastSAMapRequests	M	RO
docsBpi2CmtsIpMulticastSAMapReplies	M	RO
docsBpi2CmtsIpMulticastSAMapRejects	M	RO
docsBpi2CmtsIpMulticastSAMapRejectErrorCode	M	RO
docsBpi2CmtsIpMulticastSAMapRejectErrorString	M	RO
docsBpi2CmtsIpMulticastMapControl	M	RO
docsBpi2CmtsIpMulticastMapStorageType	M	RO
<b>docsBpi2CmtsMulticastAuthTable</b>	D	N-Acc
<b>docsBpi2CmtsMulticastAuthEntry</b>	D	N-Acc
docsBpi2CmtsMulticastAuthSAId	D	N-Acc
docsBpi2CmtsMulticastAuthCmMacAddress	D	N-Acc
docsBpi2CmtsMulticastAuthControl	D	RC/RO
<b>docsBpi2CmtsProvisionedCmCertTable</b>	M	N-Acc
<b>docsBpi2CmtsProvisionedCmCertEntry</b>	M	N-Acc
docsBpi2CmtsProvisionedCmCertMacAddress	M	N-Acc
docsBpi2CmtsProvisionedCmCertTrust	M	RC
docsBpi2CmtsProvisionedCmCertSource	M	RO
docsBpi2CmtsProvisionedCmCertStatus	M	RC
docsBpi2CmtsProvisionedCmCert	M	RC
<b>docsBpi2CmtsCACertTable</b>	M	N-Acc
<b>docsBpi2CmtsCACertEntry</b>	M	N-Acc
docsBpi2CmtsCACertIndex	M	N-Acc
docsBpi2CmtsCACertSubject	M	RO
docsBpi2CmtsCACertIssuer	M	RO
docsBpi2CmtsCACertSerialNumber	M	RO
docsBpi2CmtsCACertTrust	M	RC
docsBpi2CmtsCACertSource	M	RO
docsBpi2CmtsCACertStatus	M	RC
docsBpi2CmtsCACert	M	RC
docsBpi2CmtsCACertThumbprint	M	RO

<b>docsBpi2CodeDownloadGroup</b>		
docsBpi2CodeDownloadStatusCode	O	RO
docsBpi2CodeDownloadStatusString	O	RO
docsBpi2CodeMfgOrgName	O	RO
docsBpi2CodeMfgCodeAccessStart	O	RO
docsBpi2CodeMfgCvcAccessStart	O	RO
docsBpi2CodeCoSignerOrgName	O	RO
docsBpi2CodeCoSignerCodeAccessStart	O	RO
docsBpi2CodeCoSignerCvcAccessStart	O	RO
docsBpi2CodeCvcUpdate	O	RW
<b>DOCS-LOADBAL3-MIB [DOCS-LOADBAL3-MIB]</b>		
<b>Object</b>	<b>CMTS</b>	<b>Access</b>
<b>docsLoadbal3System</b>		
docsLoadbal3SystemEnable	M	RW
docsLoadbal3SystemEnableError	M	RO
<b>docsLoadbal3ChgOverGroup</b>		
docsLoadbal3ChgOverGroupMacAddress	M	RW
docsLoadbal3ChgOverGroupInitTech	M	RW
docsLoadbal3ChgOverGroupForceUCC	M	RW
docsLoadbal3ChgOverGroupdownFrequency	M	RW
docsLoadbal3ChgOverGroupMdlfIndex	M	RW
docsLoadbal3ChgOverGroupRcpId	M	RW
docsLoadbal3ChgOverGroupRcclId	M	RW
docsLoadbal3ChgOverGroupUsChSet	M	RW
docsLoadbal3ChgOverGroupServiceFlowInfo	M	RW
docsLoadbal3ChgOverGroupTransactionId	M	RW
docsLoadbal3ChgOverGroupCommit	M	RW
docsLoadbal3ChgOverGroupLastCommit	M	RO
<b>docsLoadbal3ChgOverStatusTable</b>	M	N-Acc
<b>docsLoadbal3ChgOverStatusEntry</b>	M	N-Acc
docsLoadbal3ChgOverStatusId	M	RO
docsLoadbal3ChgOverStatusMacAddr	M	RO
docsLoadbal3ChgOverStatusInitTech	M	RO
docsLoadbal3ChgOverStatusDownFrequency	M	RO
docsLoadbal3ChgOverStatusMdlfIndex	M	RO
docsLoadbal3ChgOverStatusRcpId	M	RO
docsLoadbal3ChgOverStatusRcclId	M	RO
docsLoadbal3ChgOverStatusUsChSet	M	RO
docsLoadbal3ChgOverStatusServiceFlowInfo	M	RO
docsLoadbal3ChgOverStatusCmd	M	RO
docsLoadbal3ChgOverStatusTransactionId	M	RO
docsLoadbal3ChgOverStatusValue	M	RO
docsLoadbal3ChgOverStatusUpdate	M	RO
<b>docsLoadbal3CmtsCmParamsTable</b>	M	N-Acc

<b>docsLoadbal3CmtsCmParamsEntry</b>	M	N-Acc
docsLoadbal3CmtsCmParamsProvGrpId	M	RW/RO
docsLoadbal3CmtsCmParamsCurrentGrpId	M	RO
docsLoadbal3CmtsCmParamsProvServiceTypeId	M	RW/RO
docsLoadbal3CmtsCmParamsCurrentServiceTypeId	M	RO
docsLoadbal3CmtsCmParamsPolicyId	M	RW/RO
docsLoadbal3CmtsCmParamsPriority	M	RW/RO
<b>docsLoadbal3GeneralGrpDefaults</b>		
docsLoadbal3GeneralGrpDefaultsEnable	M	RW
docsLoadbal3GeneralGrpDefaultsPolicyId	M	RW
docsLoadbal3GeneralGrpDefaultsInitTech	M	RW
<b>docsLoadbal3GeneralGrpCfgTable</b>	M	N-Acc
<b>docsLoadbal3GeneralGrpCfgEntry</b>	M	N-Acc
docsLoadbal3GeneralGrpCfgNodeName	M	N-Acc
docsLoadbal3GeneralGrpCfgEnable	M	RW
docsLoadbal3GeneralGrpCfgPolicyId	M	RW
docsLoadbal3GeneralGrpCfgInitTech	M	RW
<b>docsLoadbal3ResGrpCfgTable</b>	M	N-Acc
<b>docsLoadbal3ResGrpCfgEntry</b>	M	N-Acc
docsLoadbal3ResGrpCfgId	M	N-Acc
docsLoadbal3ResGrpCfgMdlfIndex	M	RC
docsLoadbal3ResGrpCfgDsChList	M	RC
docsLoadbal3ResGrpCfgUsChList	M	RC
docsLoadbal3ResGrpCfgEnable	M	RC
docsLoadbal3ResGrpCfgInitTech	M	RC
docsLoadbal3ResGrpCfgPolicyId	M	RC
docsLoadbal3ResGrpCfgServiceTypeId	M	RC
docsLoadbal3ResGrpCfgStatus	M	RC
<b>docsLoadbal3GrpStatusTable</b>	M	N-Acc
<b>docsLoadbal3GrpStatusEntry</b>	M	N-Acc
docsLoadbal3GrpStatusId	M	N-Acc
docsLoadbal3GrpStatusCfgIdOrZero	M	RO
docsLoadbal3GrpStatusMdlfIndex	M	RO
docsLoadbal3GrpStatusMdCmSgId	M	RO
docsLoadbal3GrpStatusDsChList	M	RO
docsLoadbal3GrpStatusUsChList	M	RO
docsLoadbal3GrpStatusEnable	M	RO
docsLoadbal3GrpStatusInitTech	M	RO
docsLoadbal3GrpStatusPolicyId	M	RO
docsLoadbal3GrpStatusChgOverSuccess	M	RO
docsLoadbal3GrpStatusChgOverFails	M	RO
<b>docsLoadbal3RestrictCmCfgTable</b>	M	N-Acc
<b>docsLoadbal3RestrictCmCfgEntry</b>	M	N-Acc
docsLoadbal3RestrictCmCfgId	M	N-Acc



docsLoadbal3RestrictCmCfgMacAddr	M	RC
docsLoadbal3RestrictCmCfgMacAddrMask	M	RC
docsLoadbal3RestrictCmCfgGrpId	M	RC
docsLoadbal3RestrictCmCfgServiceTypeId	M	RC
docsLoadbal3RestrictCmCfgStatus	M	RC
<b>docsLoadbal3PolicyTable</b>	M	N-Acc
<b>docsLoadbal3PolicyEntry</b>	M	N-Acc
docsLoadbal3PolicyId	M	N-Acc
docsLoadbal3PolicyRuleId	M	N-Acc
docsLoadbal3PolicyPtr	M	RC
docsLoadbal3PolicyRowStatus	M	RC
<b>docsLoadbal3BasicRuleTable</b>	M	N-Acc
<b>docsLoadbal3BasicRuleEntry</b>	M	N-Acc
docsLoadbal3BasicRuleId	M	N-Acc
docsLoadbal3BasicRuleEnable	M	RC
docsLoadbal3BasicRuleDisStart	M	RC
docsLoadbal3BasicRuleDisPeriod	M	RC
docsLoadbal3BasicRuleRowStatus	M	RC
<b>DOCS-IFEXT2-MIB [DOCS-IFEXT2-MIB]</b>		
<b>Object</b>	<b>CMTS</b>	<b>Access</b>
<b>docslfExt2CmtsObjects</b>		
docslfExt2CmtsMscGlobalEnable	M	RW
<b>docslfExt2CmtsCmMscStatusTable</b>	O	N-Acc
<b>docslfExt2CmtsCmMscStatusEntry</b>	O	N-Acc
docslfExt2CmtsCmMscStatusPowerShortfall	O	RO
docslfExt2CmtsCmMscStatusCodeRatio	O	RO
docslfExt2CmtsCmMscStatusMaximumScheduledCodes	O	RO
docslfExt2CmtsCmMscStatusPowerHeadroom	O	RO
docslfExt2CmtsCmMscStatusMeasuredSNR	O	RO
docslfExt2CmtsCmMscStatusEffectiveSNR	O	RO
<b>docslfExt2CmtsUpChannelMscTable</b>	O	N-Acc
<b>docslfExt2CmtsUpChannelMscEntry</b>	O	N-Acc
docslfExt2CmtsUpChannelMscState	O	RW
docslfExt2CmtsUpChannelMSCTotalCMTs	O	RO
docslfExt2CmtsUpChannelMSCLimitUC1	O	RO
docslfExt2CmtsUpChannelMSCMinimumValue	O	RW
<b>docslfExt2CmtsUpChannelTable</b>	O	N-Acc
<b>docslfExt2CmtsUpChannelEntry</b>	O	N-Acc
docslfExt2CmtsUpChannelTotalCMTs	O	RO
<b>HOST-RESOURCES-MIB [RFC 2790]</b>		
<b>Object</b>	<b>CMTS</b>	<b>Access</b>
<b>hrDeviceTable</b>	O	N-Acc
<b>hrDeviceEntry</b>	O	N-Acc
hrDeviceIndex	O	RO

hrDeviceType	O	RO
hrDeviceDescr	O	RO
hrDeviceID	O	RO
hrDeviceStatus	O	RO
hrDeviceErrors	O	RO
<b>hrSystem</b>		
hrMemorySize	O	RO
<b>hrStorageTable</b>	O	N-Acc
<b>hrStorageEntry</b>	O	N-Acc
hrStorageIndex	O	RO
hrStorageType	O	RO
hrStorageDescr	O	RO
hrStorageAllocationUnits	O	RO
hrStorageSize	O	RO
hrStorageUsed	O	RO
hrStorageAllocationFailures	O	RO
<b>hrSWRunTable</b>	O	N-Acc
<b>hrSWRunEntry</b>	O	N-Acc
hrSWRunIndex	O	RO
hrSWRunName	O	RO
hrSWRunID	O	RO
hrSWRunPath	O	RO
hrSWRunParameters	O	RO
hrSWRunType	O	RO
hrSWRunStatus	O	RO
<b>hrSWRunPerfTable</b>	O	N-Acc
<b>hrSWRunPerfEntry</b>	O	N-Acc
hrSWRunIndex	O	N-Acc
hrSWRunPerfCPU	O	RO
hrSWRunPerfMem	O	RO
<b>hrProcessorTable</b>	O	N-Acc
<b>hrProcessorEntry</b>	O	N-Acc
hrProcessorFrwID	O	RO
hrProcessorLoad	O	RO
<b>ENTITY-MIB [RFC 2133]</b>		
<b>Object</b>	<b>CMTS</b>	<b>Access</b>
<b>entPhysicalTable</b>	O	N-Acc
<b>entPhysicalEntry</b>	O	N-Acc
entPhysicalIndex	O	N-Acc
entPhysicalDescr	O	RO
entPhysicalVendorType	O	RO
entPhysicalContainedIn	O	RO
entPhysicalClass	O	RO
entPhysicalParentRelPos	O	RO

entPhysicalName	O	RO
entPhysicalHardwareRev	O	RO
entPhysicalFirmwareRev	O	RO
entPhysicalSoftwareRev	O	RO
entPhysicalSerialNum	O	RO/RW
entPhysicalMfgName	O	RO
entPhysicalModelName	O	RO
entPhysicalAlias	O	RO/RW
entPhysicalAssetID	O	RO/RW
entPhysicalsFRU	O	RO
entPhysicalMfgDate	O	RO
entPhysicalUris	O	RW
<b>entLogicalTable</b>	O	N-Acc
<b>entLogicalEntry</b>	O	N-Acc
entLogicalIndex	O	N-Acc
entLogicalDescr	O	RO
entLogicalType	O	RO
entLogicalCommunity	D	RO
entLogicalTAddress	O	RO
entLogicalTDomain	O	RO
entLogicalContextEngineID	O	RO
entLogicalContextName	O	RO
<b>entLPMMappingTable</b>	O	N-Acc
<b>entLPMMappingEntry</b>	O	N-Acc
entLPPhysicalIndex	O	RO
<b>entAliasMappingTable</b>	O	N-Acc
<b>entAliasMappingEntry</b>	O	N-Acc
entAliasLogicalIndexOrZero	O	N-Acc
entAliasMappingIdentifier	O	RO
<b>entPhysicalContainsTable</b>	O	N-Acc
<b>entPhysicalContainsEntry</b>	O	N-Acc
entPhysicalChildIndex	O	RO
General Group		
entLastChangeTime	O	RO
<b>Notification</b>		
entConfigChange	O	Acc-FN
<b>ENTITY-SENSOR-MIB [RFC 3433]</b>		
<b>Object</b>	<b>CMTS</b>	<b>Access</b>
<b>entPhySensorTable</b>	O	N-Acc
<b>entPhySensorEntry</b>	O	N-Acc
entPhySensorType	O	RO
entPhySensorScale	O	RO
entPhySensorPrecision	O	RO
entPhySensorValue	O	RO

entPhySensorOperStatus	O	RO
entPhySensorUnitsDisplay	O	RO
entPhySensorValueTimeStamp	O	RO
entPhySensorValueUpdateRate	O	RO
<b>SNMP-USM-DH-OBJECTS-MIB [RFC 2786]</b>		
<b>Object</b>	<b>CMTS</b>	<b>Access</b>
usmDHParameters	O	RW
<b>usmDHUserKeyTable</b>	O	N-Acc
<b>usmDHUserKeyEntry</b>	O	N-Acc
usmDHUserAuthKeyChange	O	RC
usmDHUserOwnAuthKeyChange	O	RC
usmDHUserPrivKeyChange	O	RC
usmDHUserOwnPrivKeyChange	O	RC
<b>usmDHKickstartTable</b>	O	N-Acc
<b>usmDHKickstartEntry</b>	O	N-Acc
usmDHKickstartIndex	O	N-Acc
usmDHKickstartMyPublic	O	RO
usmDHKickstartMgrPublic	O	RO
usmDHKickstartSecurityName	O	RO
<b>SNMP-VIEW-BASED-ACM-MIB [RFC 2575]</b>		
<b>Object</b>	<b>CMTS</b>	<b>Access</b>
<b>vacmContextTable</b>	O	N-Acc
<b>vacmContextEntry</b>	O	N-Acc
vacmContextName	O	RO
<b>vacmSecurityToGroupTable</b>	O	N-Acc
<b>vacmSecurityToGroupEntry</b>	O	N-Acc
vacmSecurityModel	O	N-Acc
vacmSecurityName	O	N-Acc
vacmGroupName	O	RC
vacmSecurityToGroupStorageType	O	RC
vacmSecurityToGroupStatus	O	RC
<b>vacmAccessTable</b>	O	N-Acc
<b>vacmAccessEntry</b>	O	N-Acc
vacmAccessContextPrefix	O	N-Acc
vacmAccessSecurityModel	O	N-Acc
vacmAccessSecurityLevel	O	N-Acc
vacmAccessContextMatch	O	RC
vacmAccessReadViewName	O	RC
vacmAccessWriteViewName	O	RC
vacmAccessNotifyViewName	O	RC
vacmAccessStorageType	O	RC
vacmAccessStatus	O	RC
vacmViewSpinLock	O	RW
<b>vacmViewTreeFamilyTable</b>	O	N-Acc

<b>vacmViewTreeFamilyEntry</b>	O	N-Acc
vacmViewTreeFamilyViewName	O	N-Acc
vacmViewTreeFamilySubtree	O	N-Acc
vacmViewTreeFamilyMask	O	RC
vacmViewTreeFamilyType	O	RC
vacmViewTreeFamilyStorageType	O	RC
vacmViewTreeFamilyStatus	O	RC
<b>SNMP-COMMUNITY-MIB [RFC 3584]</b>		
<b>Object</b>	<b>CMTS</b>	<b>Access</b>
<b>snmpCommunityTable</b>	M	N-Acc
<b>snmpCommunityEntry</b>	M	N-Acc
snmpCommunityIndex	M	N-Acc
snmpCommunityName	M	RC
snmpCommunitySecurityName	M	RC
snmpCommunityContextEngineID	M	RC
snmpCommunityContextName	M	RC
snmpCommunityTransportTag	M	RC
snmpCommunityStorageType	M	RC
snmpCommunityStatus	M	RC
<b>snmpTargetAddrExtTable</b>	M	N-Acc
<b>snmpTargetAddrExtEntry</b>	M	N-Acc
snmpTargetAddrTMask	M	RC
snmpTargetAddrMMS	M	RC
snmpTrapAddress	O	ACC-FN
snmpTrapCommunity	O	ACC-FN
<b>SNMP-FRAMEWORK-MIB [RFC 3411]</b>		
<b>Object</b>	<b>CMTS</b>	<b>Access</b>
<b>snmpEngineGroup</b>		
snmpEngineID	M	RO
snmpEngineBoots	M	RO
snmpEngineTime	M	RO
snmpEngineMaxMessageSize	M	RO
<b>SNMP-MPD-MIB [RFC 3412]</b>		
<b>Object</b>	<b>CMTS</b>	<b>Access</b>
<b>snmpMPDStats</b>		
snmpUnknownSecurityModels	M	RO
snmpInvalidMsgs	M	RO
snmpUnknownPDUHandlers	M	RO
<b>SNMP Applications [RFC 2573]</b>		
<b>Object</b>	<b>CMTS</b>	<b>Access</b>
snmpTargetSpinLock	M	RW
<b>snmpTargetAddrTable</b>	M	N-Acc
<b>snmpTargetAddrEntry</b>	M	N-Acc
snmpTargetAddrName	M	N-Acc

snmpTargetAddrTDomain	M	RC
snmpTargetAddrTAddress	M	RC
snmpTargetAddrTimeout	M	RC
snmpTargetAddrRetryCount	M	RC
snmpTargetAddrTagList	M	RC
snmpTargetAddrParams	M	RC
snmpTargetAddrStorageType	M	RC
snmpTargetAddrRowStatus	M	RC
<b>snmpTargetParamsTable</b>	M	N-Acc
<b>snmpTargetParamsEntry</b>	M	N-Acc
snmpTargetParamsName	M	N-Acc
snmpTargetParamsMPModel	M	RC
snmpTargetParamsSecurityModel	M	RC
snmpTargetParamsSecurityName	M	RC
snmpTargetParamsSecurityLevel	M	RC
snmpTargetParamsStorageType	M	RC
snmpTargetParamsRowStatus	M	RC
snmpUnavailableContexts	M	RO
snmpUnknownContexts	M	RO
<b>snmpNotifyTable</b>	M	N-Acc
<b>snmpNotifyEntry</b>	M	N-Acc
snmpNotifyName	M	N-Acc
snmpNotifyTag	M	RC
snmpNotifyType	M	RC
snmpNotifyStorageType	M	RC
snmpNotifyRowStatus	M	RC
<b>snmpNotifyFilterProfileTable</b>	M	N-Acc
<b>snmpNotifyFilterProfileEntry</b>	M	N-Acc
snmpNotifyFilterProfileName	M	RC
snmpNotifyFilterProfileStorType	M	RC
snmpNotifyFilterProfileRowStatus	M	RC
<b>snmpNotifyFilterTable</b>	M	N-Acc
<b>snmpNotifyFilterEntry</b>	M	N-Acc
snmpNotifyFilterSubtree	M	N-Acc
snmpNotifyFilterMask	M	RC
snmpNotifyFilterType	M	RC
snmpNotifyFilterStorageType	M	RC
snmpNotifyFilterRowStatus	M	RC
<b>SNMP-USER-BASED-SM-MIB [RFC 3414]</b>		
<b>Object</b>	<b>CMTS</b>	<b>Access</b>
<b>usmStats</b>		
usmStatsUnsupportedSecLevels	O	RO
usmStatsNotInTimeWindows	O	RO
usmStatsUnknownUserNames	O	RO

usmStatsUnknownEngineIDs	O	RO
usmStatsWrongDigests	O	RO
usmStatsDecryptionErrors	O	RO
<b>usmUser</b>		
usmUserSpinLock	O	RW
<b>usmUserTable</b>	O	N-Acc
<b>usmUserEntry</b>	O	N-Acc
usmUserEngineID	O	N-Acc
usmUserName	O	N-Acc
usmUserSecurityName	O	RO
usmUserCloneFrom	O	RC
usmUserAuthProtocol	O	RC
usmUserAuthKeyChange	O	RC
usmUserOwnAuthKeyChange	O	RC
usmUserPrivProtocol	O	RC
usmUserPrivKeyChange	O	RC
usmUserOwnPrivKeyChange	O	RC
usmUserPublic	O	RC
usmUserStorageType	O	RC
usmUserStatus	O	RC
<b>MGMD-STD-MIB [RFC 5519]</b>		
<b>Object</b>	<b>CMTS</b>	<b>Access</b>
<b>mgmdRouterInterfaceTable</b>	M	N-Acc
<b>mgmdRouterInterfaceEntry</b>	M	N-Acc
mgmdRouterInterfaceIfIndex	M	N-Acc
mgmdRouterInterfaceQuerierType	M	N-Acc
mgmdRouterInterfaceQuerier	M	RO
mgmdRouterInterfaceQueryInterval	M	RC
mgmdRouterInterfaceStatus	M	RC
mgmdRouterInterfaceVersion	M	RC
mgmdRouterInterfaceQueryMaxResponseTime	M	RC
mgmdRouterInterfaceQuerierUpTime	M	RO
mgmdRouterInterfaceQuerierExpiryTime	M	RO
mgmdRouterInterfaceWrongVersionQueries	M	RO
mgmdRouterInterfaceJoins	M	RO
mgmdRouterInterfaceProxyIfIndex	M	RO/RC
mgmdRouterInterfaceGroups	M	RO
mgmdRouterInterfaceRobustness	M	RC
mgmdRouterInterfaceLastMemberQueryInterval	M	RC
mgmdRouterInterfaceLastMemberQueryCount	M	RO
mgmdRouterInterfaceStartupQueryCount	M	RO
mgmdRouterInterfaceStartupQueryInterval	M	RO
<b>mgmdRouterCacheTable</b>	M	N-Acc
<b>mgmdRouterCacheEntry</b>	M	N-Acc

mgmdRouterCacheAddressType	M	N-Acc
mgmdRouterCacheAddress	M	N-Acc
mgmdRouterCacheIfIndex	M	N-Acc
mgmdRouterCacheLastReporter	M	RO
mgmdRouterCacheUpTime	M	RO
mgmdRouterCacheExpiryTime	M	RO
mgmdRouterCacheExcludeModeExpiryTimer	M	RO
mgmdRouterCacheVersion1HostTimer	M	RO
mgmdRouterCacheVersion2HostTimer	M	RO
mgmdRouterCacheSourceFilterMode	M	RO
mgmdInverseRouterCacheTable	M	N-Acc
mgmdInverseRouterCacheEntry	M	N-Acc
mgmdInverseRouterCacheIfIndex	M	N-Acc
mgmdInverseRouterCacheAddressType	M	N-Acc
mgmdInverseRouterCacheAddress	M	RO
mgmdRouterSrcListTable	M	N-Acc
mgmdRouterSrcListEntry	M	N-Acc
mgmdRouterSrcListAddressType	M	N-Acc
mgmdRouterSrcListAddress	M	N-Acc
mgmdRouterSrcListIfIndex	M	N-Acc
mgmdRouterSrcListHostAddress	M	N-Acc
mgmdRouterSrcListExpire	M	RO
<b>DOCS-DIAG-MIB [DOCS-DIAG-MIB]</b>		
<b>Object</b>	<b>CMTS</b>	<b>Access</b>
<b>docsDiagLogGlobal</b>		
docsDiagLogMaxSize	M	RW
docsDiagLogCurrentSize	M	RO
docsDiagLogNotifyLogSizeHighThrshld	M	RW
docsDiagLogNotifyLogSizeLowThrshld	M	RW
docsDiagLogAging	M	RW
docsDiagLogResetAll	M	RW
docsDiagLogLastResetTime	M	RO
docsDiagLogClearAll	M	RW
docsDiagLogLastClearTime	M	RO
docsDiagLogNotifCtrl	M	RW
<b>docsDiagLogTriggersCfg</b>		
docsDiagLogIncludeTriggers	M	RW
docsDiagLogEnableAgingTriggers	M	RW
docsDiagLogRegTimeInterval	M	RW
docsDiagLogRegDetail	M	RW
docsDiagLogRangingRetryType	M	RW
docsDiagLogRangingRetryThrhd	M	RW
docsDiagLogRangingRetryStationMaintNum	M	RW
<b>docsDiagLogTable</b>	M	N-Acc



<b>docsDiagLogEntry</b>	M	N-Acc
docsDiagLogCmMacAddr	M	RO
docsDiagLogLastUpdateTime	M	RO
docsDiagLogCreateTime	M	RO
docsDiagLogLastRegTime	M	RO
docsDiagLogRegCount	M	RO
docsDiagLogRangingRetryCount	M	RO
<b>docsDiagLogDetailTable</b>	M	N-Acc
<b>docsDiagLogDetailEntry</b>	M	N-Acc
docsDiagLogDetailTypeValue	M	N-Acc
docsDiagLogDetailCount	M	RO
docsDiagLogDetailLastUpdate	M	RO
docsDiagLogDetailLastErrorText	M	RO
<b>Notifications</b>		
docsDiagLogSizeHighThrshldReached	M	Notif
docsDiagLogSizeLowThrshldReached	M	Notif
docsDiagLogSizeFull	M	Notif
<b>DOCS-QOS3-MIB [DOCS-QOS3-MIB]</b>		
<b>Object</b>	<b>CMTS</b>	<b>Access</b>
<b>docsQosPktClassTable</b>	M	N-Acc
<b>docsQosPktClassEntry</b>	M	N-Acc
docsQosPktClassId	M	N-Acc
docsQosPktClassDirection	M	RO
docsQosPktClassPriority	M	RO
docsQosPktClassIpTosLow	M	RO
docsQosPktClassIpTosHigh	M	RO
docsQosPktClassIpTosMask	M	RO
docsQosPktClassIpProtocol	M	RO
docsQosPktClassIpSourceAddr	M	RO
docsQosPktClassIpSourceMask	M	RO
docsQosPktClassIpDestAddr	M	RO
docsQosPktClassIpDestMask	M	RO
docsQosPktClassSourcePortStart	M	RO
docsQosPktClassSourcePortEnd	M	RO
docsQosPktClassDestPortStart	M	RO
docsQosPktClassDestPortEnd	M	RO
docsQosPktClassDestMacAddr	M	RO
docsQosPktClassDestMacMask	M	RO
docsQosPktClassSourceMacAddr	M	RO
docsQosPktClassEnetProtocolType	M	RO
docsQosPktClassEnetProtocol	M	RO
docsQosPktClassUserPriLow	M	RO
docsQosPktClassUserPriHigh	M	RO
docsQosPktClassVlanId	M	RO

docsQosPktClassState	M	RO
docsQosPktClassPkts	M	RO
docsQosPktClassBitMap	M	RO
docsQosPktClassIpAddrType	M	RO
docsQosPktClassFlowLabel	M	RO
docsQosPktClassIcmpTypeHigh	M	RO
docsQosPktClassIcmpTypeLow	M	RO
docsQosPktClassCmInterfaceMask	M	RO
<b>docsQosParamSetTable</b>	M	N-Acc
<b>docsQosParamSetEntry</b>	M	N-Acc
docsQosParamSetServiceClassName	M	RO
docsQosParamSetPriority	M	RO
docsQosParamSetMaxTrafficRate	M	RO
docsQosParamSetMaxTrafficBurst	M	RO
docsQosParamSetMinReservedRate	M	RO
docsQosParamSetMinReservedPkt	M	RO
docsQosParamSetActiveTimeout	M	RO
docsQosParamSetAdmittedTimeout	M	RO
docsQosParamSetMaxConcatBurst	M	RO
docsQosParamSetSchedulingType	M	RO
docsQosParamSetNomPollInterval	M	RO
docsQosParamSetTolPollJitter	M	RO
docsQosParamSetUnsolicitGrantSize	M	RO
docsQosParamSetNomGrantInterval	M	RO
docsQosParamSetTolGrantJitter	M	RO
docsQosParamSetGrantsPerInterval	M	RO
docsQosParamSetTosAndMask	M	RO
docsQosParamSetTosOrMask	M	RO
docsQosParamSetMaxLatency	M	RO
docsQosParamSetType	M	N-Acc
docsQosParamSetRequestPolicyOct	M	RO
docsQosParamSetBitMap	M	RO
docsQosParamSetServiceFlowId	M	N-Acc
docsQosParamSetRequiredAttrMask	M	RO
docsQosParamSetForbiddenAttrMask	M	RO
docsQosParamSetAttrAggrRuleMask	M	RO
docsQosParamSetAppld	M	RO
docsQosParamSetMultiplierContentionReqWindow	M	RO
docsQosParamSetMultiplierBytesReq	M	RO
docsQosParamSetMaxReqPerSidCluster	D	RO
docsQosParamSetMaxOutstandingBytesPerSidCluster	D	RO
docsQosParamSetMaxTotBytesReqPerSidCluster	D	RO
docsQosParamSetMaxTimeInSidCluster	D	RO
docsQosParamSetPeakTrafficRate	M	RO

docsQosParamSetDsResequencing	M	RO
docsQosParamSetMinimumBuffer	M	RO
docsQosParamSetTargetBuffer	M	RO
docsQosParamSetMaximumBuffer	M	RO
<b>docsQosServiceFlowTable</b>	M	N-Acc
<b>docsQosServiceFlowEntry</b>	M	N-Acc
docsQosServiceFlowId	M	N-Acc
docsQosServiceFlowSID	M	RO
docsQosServiceFlowDirection	M	RO
docsQosServiceFlowPrimary	M	RO
docsQosServiceFlowParamSetTypeStatus	M	RO
docsQosServiceFlowChSetId	M	RO
docsQosServiceFlowAttrAssignSuccess	M	RO
docsQosServiceFlowDsid	M	RO
docsQosServiceFlowMaxReqPerSidCluster	M	RO
docsQosServiceFlowMaxOutstandingBytesPerSidCluster	M	RO
docsQosServiceFlowMaxTotBytesReqPerSidCluster	M	RO
docsQosServiceFlowMaxTimeInSidCluster	M	RO
docsQosServiceFlowBufferSize	O	RO
docsQosServiceFlowIatcProfileName	M	RO
<b>docsQosServiceFlowStatsTable</b>	M	N-Acc
<b>docsQosServiceFlowStatsEntry</b>	M	N-Acc
docsQosServiceFlowPkts	M	RO
docsQosServiceFlowOctets	M	RO
docsQosServiceFlowTimeCreated	M	RO
docsQosServiceFlowTimeActive	M	RO
docsQosServiceFlowPHSUnknowns	D	RO
docsQosServiceFlowPolicedDropPkts	M	RO
docsQosServiceFlowPolicedDelayPkts	M	RO
<b>Object</b>	<b>CMTS</b>	<b>Access</b>
<b>docsQosUpstreamStatsTable</b>	M	N-Acc
<b>docsQosUpstreamStatsEntry</b>	M	N-Acc
docsQosSID	M	N-Acc
docsQosUpstreamFragments	M	RO
docsQosUpstreamFragDiscards	M	RO
docsQosUpstreamConcatBursts	M	RO
<b>Object</b>	<b>CMTS</b>	<b>Access</b>
<b>docsQosDynamicServiceStatsTable</b>	M	N-Acc
<b>docsQosDynamicServiceStatsEntry</b>	M	N-Acc
docsQosIfDirection	M	N-Acc
docsQosDSAReqs	M	RO
docsQosDSARsps	M	RO
docsQosDSAAcks	M	RO
docsQosDSCReq	M	RO

docsQosDSCRsps	M	RO
docsQosDSCAcks	M	RO
docsQosDSDReqs	M	RO
docsQosDSDRsps	M	RO
docsQosDynamicAdds	M	RO
docsQosDynamicAddFails	M	RO
docsQosDynamicChanges	M	RO
docsQosDynamicChangeFails	M	RO
docsQosDynamicDeletes	M	RO
docsQosDynamicDeleteFails	M	RO
docsQosDCCRreqs	M	RO
docsQosDCCRsps	M	RO
docsQosDCCAcks	M	RO
docsQosDCCs	M	RO
docsQosDCCFails	M	RO
docsQosDCCRspDeparts	M	RO
docsQosDCCRspArrives	M	RO
docsQosDbcReqs	M	RO
docsQosDbcRsps	M	RO
docsQosDbcAcks	M	RO
docsQosDbcSuccesses	M	RO
docsQosDbcFails	M	RO
docsQosDbcPartial	M	RO
<b>Object</b>	<b>CMTS</b>	<b>Access</b>
<b>docsQosServiceFlowLogTable</b>	M	N-Acc
<b>docsQosServiceFlowLogEntry</b>	M	N-Acc
docsQosServiceFlowLogIndex	M	N-Acc
docsQosServiceFlowLogIfIndex	M	RO
docsQosServiceFlowLogSFID	M	RO
docsQosServiceFlowLogCmMac	M	RO
docsQosServiceFlowLogPkts	M	RO
docsQosServiceFlowLogOctets	M	RO
docsQosServiceFlowLogTimeDeleted	M	RO
docsQosServiceFlowLogTimeCreated	M	RO
docsQosServiceFlowLogTimeActive	M	RO
docsQosServiceFlowLogDirection	M	RO
docsQosServiceFlowLogPrimary	M	RO
docsQosServiceFlowLogServiceClassName	M	RO
docsQosServiceFlowLogPolicedDropPkts	M	RO
docsQosServiceFlowLogPolicedDelayPkts	M	RO
docsQosServiceFlowLogControl	M	RW
<b>docsQosServiceClassTable</b>	M	N-Acc
<b>docsQosServiceClassEntry</b>	M	N-Acc
docsQosServiceClassName	M	N-Acc

docsQosServiceClassStatus	M	RC
docsQosServiceClassPriority	M	RC
docsQosServiceClassMaxTrafficRate	M	RC
docsQosServiceClassMaxTrafficBurst	M	RC
docsQosServiceClassMinReservedRate	M	RC
docsQosServiceClassMinReservedPkt	M	RC
docsQosServiceClassMaxConcatBurst	M	RC
docsQosServiceClassNomPollInterval	M	RC
docsQosServiceClassToIPollJitter	M	RC
docsQosServiceClassUnsolicitGrantSize	M	RC
docsQosServiceClassNomGrantInterval	M	RC
docsQosServiceClassToIGrantJitter	M	RC
docsQosServiceClassGrantsPerInterval	M	RC
docsQosServiceClassMaxLatency	M	RC
docsQosServiceClassActiveTimeout	M	RC
docsQosServiceClassAdmittedTimeout	M	RC
docsQosServiceClassSchedulingType	M	RC
docsQosServiceClassRequestPolicy	M	RC
docsQosServiceClassTosAndMask	M	RC
docsQosServiceClassTosOrMask	M	RC
docsQosServiceClassDirection	M	RC
docsQosServiceClassStorageType	M	RC
docsQosServiceClassDSCPOverwrite	M	RC
docsQosServiceClassRequiredAttrMask	M	RC
docsQosServiceClassForbiddenAttrMask	M	RC
docsQosServiceClassAttrAggrRuleMask	M	RC
docsQosServiceClassAppld	M	RC
docsQosServiceClassMultiplierContentionReqWindow	M	RC
docsQosServiceClassMultiplierBytesReq	M	RC
docsQosServiceClassMaxReqPerSidCluster	D	RC
docsQosServiceClassMaxOutstandingBytesPerSidCluster	D	RC
docsQosServiceClassMaxTotBytesReqPerSidCluster	D	RC
docsQosServiceClassMaxTimeInSidCluster	D	RC
docsQosServiceClassPeakTrafficRate	M	RC
docsQosServiceClassDsResequencing	M	RC
docsQosServiceClassMinimumBuffer	M	RC
docsQosServiceClassTargetBuffer	M	RC
docsQosServiceClassMaximumBuffer	M	RC
<b>Object</b>	<b>CMTS</b>	<b>Access</b>
<b>docsQosPHSTable</b>	D	N-Acc
<b>docsQosPHSEntry</b>	D	N-Acc
docsQosPHSField	D	RO
docsQosPHSMask	D	RO
docsQosPHSSize	D	RO

docsQosPHSVerify	D	RO
docsQosPHSIndex	D	RO
<b>Object</b>	<b>CMTS</b>	<b>Access</b>
<b>docsQosCmtsMacToSrvFlowTable</b>	M	N-Acc
<b>docsQosCmtsMacToSrvFlowEntry</b>	M	N-Acc
docsQosCmtsCmMac	M	N-Acc
docsQosCmtsServiceFlowId	M	N-Acc
docsQosCmtsIflIndex	M	RO
<b>Object</b>	<b>CMTS</b>	<b>Access</b>
<b>docsQosServiceFlowSidClusterTable</b>	M	N-Acc
<b>docsQosServiceFlowSidClusterEntry</b>	M	N-Acc
docsQosServiceFlowSidClusterId	M	N-Acc
docsQosServiceFlowSidClusterUcid	M	N-Acc
docsQosServiceFlowSidClusterSid	M	RO
<b>Object</b>	<b>CMTS</b>	<b>Access</b>
<b>docsQosGrpServiceFlowTable</b>	M	N-Acc
<b>docsQosGrpServiceFlowEntry</b>	M	N-Acc
docsQosGrpServiceFlowsDef	M	RO
docsQosGrpServiceFlowQosConfigId	M	RO
docsQosGrpServiceFlowNumSess	M	RO
docsQosGrpServiceFlowSrcAddr	M	RO
docsQosGrpServiceFlowGrpAddr	M	RO
<b>docsQosGrpPktClassTable</b>	M	N-Acc
<b>docsQosGrpPktClassEntry</b>	M	N-Acc
docsQosGrpPktClassGrpConfigId	M	RO
<b>docsQosUpChCounterExtTable</b>	M	N-Acc
<b>docsQosUpChCounterExtEntry</b>	M	N-Acc
docsQosUpChCounterExtSgmtValid	M	RO
docsQosUpChCounterExtSgmtDiscards	M	RO
<b>docsQosServiceFlowCcfStatsTable</b>	M	N-Acc
<b>docsQosServiceFlowCcfStatsEntry</b>	M	N-Acc
docsQosServiceFlowCcfStatsSgmtValid	M	RO
docsQosServiceFlowCcfStatsSgmtLost	M	RO
<b>Object</b>	<b>CMTS</b>	<b>Access</b>
<b>docsQosCmtsDsidTable</b>	M	N-Acc
<b>docsQosCmtsDsidEntry</b>	M	N-Acc
docsQosCmtsDsidDsid	M	N-Acc
docsQosCmtsDsidUsage	M	RO
docsQosCmtsDsidDsChSet	M	RO
docsQosCmtsDsidReseqWaitTime	M	RO
docsQosCmtsDsidReseqWarnThrshld	M	RO
docsQosCmtsDsidStatusHoldOffTimerSeqOutOfRng	M	RO
docsQosCmtsDsidCurrentSeqNum	M	RO
<b>docsQosCmtsDebugDsidTable</b>	M	N-Acc

<b>docsQosCmtsDebugDsidEntry</b>	M	N-Acc
docsQosCmtsDebugDsidDsid	M	N-Acc
docsQosCmtsDebugDsidRowStatus	M	RC
<b>docsQosCmtsDebugDsidStatsTable</b>	M	N-Acc
<b>docsQosCmtsDebugDsidStatsEntry</b>	M	N-Acc
docsQosCmtsDebugDsidStatsDslfIndex	M	N-Acc
docsQosCmtsDebugDsidStatsDsidPackets	M	RO
docsQosCmtsDebugDsidStatsDsidOctets	M	RO
<b>docsQosCmtsIatcProfileStatsTable</b>	M	N-Acc
<b>docsQosCmtsIatcProfileStatsEntry</b>	M	N-Acc
docsQosCmtsIatcProfileStatsName	M	N-Acc
docsQosCmtsIatcProfileStatsIflIndex	M	RO
docsQosCmtsIatcProfileStatsDirection	M	RO
docsQosCmtsIatcProfileStatsPkts	M	RO
docsQosCmtsIatcProfileStatsOctets	M	RO
docsQosCmtsIatcProfileStatsPolicedDropPkts	M	RO
docsQosCmtsIatcProfileStatsPolicedDelayPkts	M	RO
<b>DOCS-IF3-MIB [DOCS-IF3-MIB]</b>		
<b>Object</b>	<b>CMTS</b>	<b>Access</b>
<b>docslf3MdNodeStatusTable</b>	M	N-Acc
<b>docslf3MdNodeStatusEntry</b>	M	N-Acc
docslf3MdNodeStatusNodeName	M	N-Acc
docslf3MdNodeStatusMdCmSgld	M	N-Acc
docslf3MdNodeStatusMdDsSgld	M	RO
docslf3MdNodeStatusMdUsSgld	M	RO
<b>docslf3MdDsSgStatusTable</b>	M	N-Acc
<b>docslf3MdDsSgStatusEntry</b>	M	N-Acc
docslf3MdDsSgStatusMdDsSgld	M	N-Acc
docslf3MdDsSgStatusChSetId	M	RO
<b>docslf3MdUsSgStatusTable</b>	M	N-Acc
<b>docslf3MdUsSgStatusEntry</b>	M	N-Acc
docslf3MdUsSgStatusMdUsSgld	M	N-Acc
docslf3MdUsSgStatusChSetId	M	RO
<b>docslf3CmtsCmRegStatusTable</b>	M	N-Acc
<b>docslf3CmtsCmRegStatusEntry</b>	M	N-Acc
docslf3CmtsCmRegStatusId	M	N-Acc
docslf3CmtsCmRegStatusMacAddr	M	RO
docslf3CmtsCmRegStatusIPv6Addr	M	RO
docslf3CmtsCmRegStatusIPv6LinkLocal	M	RO
docslf3CmtsCmRegStatusIPv4Addr	M	RO
docslf3CmtsCmRegStatusValue	M	RO
docslf3CmtsCmRegStatusMdlfIndex	M	RO
docslf3CmtsCmRegStatusMdCmSgld	M	RO
docslf3CmtsCmRegStatusRcpId	M	RO

docslf3CmtsCmRegStatusRccStatusId	M	RO
docslf3CmtsCmRegStatusRcsId	M	RO
docslf3CmtsCmRegStatusTcsId	M	RO
docslf3CmtsCmRegStatusQosVersion	M	RO
docslf3CmtsCmRegStatusLastRegTime	M	RO
docslf3CmtsCmRegStatusAddrResolutionReqs	M	RO
docslf3CmtsCmRegStatusEnergyMgtEnabled	M	RO
docslf3CmtsCmRegStatusEnergyMgtOperStatus	M	RO
<b>docslf3CmtsCmUsStatusTable</b>	M	N-Acc
<b>docslf3CmtsCmUsStatusEntry</b>	M	N-Acc
docslf3CmtsCmUsStatusChIfIndex	M	N-Acc
docslf3CmtsCmUsStatusModulationType	M	RO
docslf3CmtsCmUsStatusRxPower	M	RO
docslf3CmtsCmUsStatusSignalNoise	M	RO
docslf3CmtsCmUsStatusMicroreflections	M	RO
docslf3CmtsCmUsStatusEqData	M	RO
docslf3CmtsCmUsStatusUnerrored	M	RO
docslf3CmtsCmUsStatusCorrecteds	M	RO
docslf3CmtsCmUsStatusUncorrectables	M	RO
docslf3CmtsCmUsStatusHighResolutionTimingOffset	M	RO
docslf3CmtsCmUsStatusIsMuted	M	RO
docslf3CmtsCmUsStatusRangingStatus	M	RO
<b>docslf3MdCfgTable</b>	M	N-Acc
<b>docslf3MdCfgEntry</b>	M	N-Acc
docslf3MdCfgMddInterval	M	RW
docslf3MdCfgIpProvMode	M	RW
docslf3MdCfgCmStatusEvCtlEnabled	M	RW
docslf3MdCfgUsFreqRange	M	RW
docslf3MdCfgMcastDsidFwdEnabled	O	RW
docslf3MdCfgMultRxChModeEnabled	M	RW
docslf3MdCfgMultTxChModeEnabled	M	RW
docslf3MdCfgEarlyAuthEncrCtrl	M	RW
docslf3MdCfgTftpProxyEnabled	M	RW
docslf3MdCfgSrcAddrVerifEnabled	M	RW
docslf3MdCfgDownChannelAnnex	M	RW
docslf3MdCfgCmUdcEnabled	M	RW
docslf3MdCfgSendUdcRulesEnabled	O	RW
docslf3MdCfgServiceTypeIdList	M	RW
docslf3MdCfgBpi2EnforceCtrl	M	RW
docslf3MdCfgEnergyMgt1x1Enabled	M	RW
<b>docslf3MdChCfgTable</b>	M	N-Acc
<b>docslf3MdChCfgEntry</b>	M	N-Acc
docslf3MdChCfgChIfIndex	M	N-Acc
docslf3MdChCfgIsPriCapableDs	M	RC



docslf3MdChCfgChId	M	RC
docslf3MdChCfgSfProvAttrMask	M	RC
docslf3MdChCfgRowStatus	M	RC
<b>docslf3MdUsToDsChMappingTable</b>	M	N-Acc
<b>docslf3MdUsToDsChMappingEntry</b>	M	N-Acc
docslf3MdUsToDsChMappingUsIfIndex	M	N-Acc
docslf3MdUsToDsChMappingDsIfIndex	M	N-Acc
docslf3MdUsToDsChMappingMdlfIndex	M	RO
<b>docslf3DsChSetTable</b>	M	N-Acc
<b>docslf3DsChSetEntry</b>	M	N-Acc
docslf3DsChSetId	M	N-Acc
docslf3DsChSetChList	M	RO
<b>docslf3UsChSetTable</b>	M	N-Acc
<b>docslf3UsChSetEntry</b>	M	N-Acc
docslf3UsChSetId	M	N-Acc
docslf3UsChSetChList	M	RO
<b>docslf3BondingGrpCfgTable</b>	M	N-Acc
<b>docslf3BondingGrpCfgEntry</b>	M	N-Acc
docslf3BondingGrpCfgDir	M	N-Acc
docslf3BondingGrpCfgCfGld	M	N-Acc
docslf3BondingGrpCfgChList	M	RC
docslf3BondingGrpCfgSfProvAttrMask	M	RC
docslf3BondingGrpCfgDsidReseqWaitTime	M	RC
docslf3BondingGrpCfgDsidReseqWarnThrshld	M	RC
docslf3BondingGrpCfgRowStatus	M	RC
<b>docslf3DsBondingGrpStatusTable</b>	M	N-Acc
<b>docslf3DsBondingGrpStatusEntry</b>	M	N-Acc
docslf3DsBondingGrpStatusChSetId	M	N-Acc
docslf3DsBondingGrpStatusMdDsSgld	M	RO
docslf3DsBondingGrpStatusCfGld	M	RO
<b>docslf3UsBondingGrpStatusTable</b>	M	N-Acc
<b>docslf3UsBondingGrpStatusEntry</b>	M	N-Acc
docslf3UsBondingGrpStatusChSetId	M	N-Acc
docslf3UsBondingGrpStatusMdUsSgld	M	RO
docslf3UsBondingGrpStatusCfGld	M	RO
<b>docslf3RccCfgTable</b>	D	N-Acc
<b>docslf3RccCfgEntry</b>	D	N-Acc
docslf3RccCfgRcpld	D	N-Acc
docslf3RccCfgRccCfGld	D	N-Acc
docslf3RccCfgVendorSpecific	D	RC
docslf3RccCfgDescription	D	RC
docslf3RccCfgRowStatus	D	RC
<b>docslf3RxChCfgTable</b>	D	N-Acc
<b>docslf3RxChCfgEntry</b>	D	N-Acc

docslf3RxChCfgRcld	D	N-Acc
docslf3RxChCfgChIfIndex	D	RO
docslf3RxChCfgPrimaryDsIndicator	D	RC
docslf3RxChCfgRcRmConnectivityId	D	RC
docslf3RxChCfgRowStatus	D	RC
<b>docslf3RxModuleCfgTable</b>	D	N-Acc
<b>docslf3RxModuleCfgEntry</b>	D	N-Acc
docslf3RxModuleCfgRmId	D	N-Acc
docslf3RxModuleCfgRmRmConnectivityId	D	RC
docslf3RxModuleCfgFirstCenterFrequency	D	RC
docslf3RxModuleCfgRowStatus	D	RC
<b>docslf3RccStatusTable</b>	M	N-Acc
<b>docslf3RccStatusEntry</b>	M	N-Acc
docslf3RccStatusRcpld	M	N-Acc
docslf3RccStatusRccStatusId	M	N-Acc
docslf3RccStatusRccCfgId	M	RO
docslf3RccStatusValidityCode	M	RO
docslf3RccStatusValidityCodeText	M	RO
<b>docslf3RxChStatusTable</b>	M	N-Acc
<b>docslf3RxChStatusEntry</b>	M	N-Acc
docslf3RxChStatusRcld	M	N-Acc
docslf3RxChStatusChIfIndex	M	RO
docslf3RxChStatusPrimaryDsIndicator	M	RO
docslf3RxChStatusRcRmConnectivityId	M	RO
<b>docslf3RxModuleStatusTable</b>	M	N-Acc
<b>docslf3RxModuleStatusEntry</b>	M	N-Acc
docslf3RxModuleStatusRmId	M	N-Acc
docslf3RxModuleStatusRmRmConnectivityId	M	RO
docslf3RxModuleStatusFirstCenterFrequency	M	RO
<b>docslf3SignalQualityExtTable</b>	M	N-Acc
<b>docslf3SignalQualityExtEntry</b>	M	N-Acc
docslf3SignalQualityExtRxMER	M	RO
docslf3SignalQualityExtRxMerSamples	M	RO
<b>docslf3CmtsSignalQualityExtTable</b>	M	N-Acc
<b>docslf3CmtsSignalQualityExtEntry</b>	M	N-Acc
docslf3CmtsSignalQualityExtCNIR	M	RO
docslf3CmtsSignalQualityExtExpectedRxSignalPower	M	RW
<b>docslf3CmtsSpectrumAnalysisMeasTable</b>	M	N-Acc
<b>docslf3CmtsSpectrumAnalysisMeasEntry</b>	M	N-Acc
docslf3CmtsSpectrumAnalysisMeasAmplitudeData	M	RO
docslf3CmtsSpectrumAnalysisMeasTimeInterval	M	RO
docslf3CmtsSpectrumAnalysisMeasRowStatus	M	RC
<b>docslf3UsChExtTable</b>	M	N-Acc
<b>docslf3UsChExtEntry</b>	M	N-Acc

docsIf3UsChExtSacCodeHoppingSelectionMode	M	RO
docsIf3UsChExtScdmaSelectionStringActiveCodes	M	RO
<b>docsIf3CmtsCmCtrlCmd</b>		
docsIf3CmtsCmCtrlCmdMacAddr	M	RW
docsIf3CmtsCmCtrlCmdMuteUsChId	M	RW
docsIf3CmtsCmCtrlCmdMuteInterval	M	RW
docsIf3CmtsCmCtrlCmdDisableForwarding	M	RW
docsIf3CmtsCmCtrlCmdCommit	M	RW
<b>docsIf3CmtsEventCtrlTable</b>	M	N-Acc
<b>docsIf3CmtsEventCtrlEntry</b>	M	N-Acc
docsIf3CmtsEventCtrlEventId	M	N-Acc
docsIf3CmtsEventCtrlStatus	M	RC
<b>docsIf3CmtsCmEmStatsTable</b>	M	N-Acc
<b>docsIf3CmtsCmEmStatsEntry</b>	M	N-Acc
docsIf3CmtsCmEmStatsEm1x1ModeTotalDuration	M	RO
<b>Notifications</b>		
docsIf3CmtsEventNotif	M	Notif
<b>DOCS-SUBMGT3-MIB [DOCS-SUBMGT3-MIB]</b>		
<b>Object</b>	<b>CMTS</b>	<b>Access</b>
<b>docsSubmgt3Base</b>		
docsSubmgt3BaseCpeMaxIpv4Def	M	RW
docsSubmgt3BaseCpeMaxIpv6AddressesDef	D	RW
docsSubmgt3BaseCpeMaxIpv6PrefixesDef	M	RW
docsSubmgt3BaseCpeActiveDef	M	RW
docsSubmgt3BaseCpeLearnableDef	M	RW
docsSubmgt3BaseSubFilterDownDef	M	RW
docsSubmgt3BaseSubFilterUpDef	M	RW
docsSubmgt3BaseCmFilterDownDef	M	RW
docsSubmgt3BaseCmFilterUpDef	M	RW
docsSubmgt3BasePsFilterDownDef	M	RW
docsSubmgt3BasePsFilterUpDef	M	RW
docsSubmgt3BaseMtaFilterDownDef	M	RW
docsSubmgt3BaseMtaFilterUpDef	M	RW
docsSubmgt3BaseStbFilterDownDef	M	RW
docsSubmgt3BaseStbFilterUpDef	M	RW
<b>docsSubmgt3CpeCtrlTable</b>	M	N-Acc
<b>docsSubmgt3CpeCtrlEntry</b>	M	N-Acc
docsSubmgt3CpeCtrlMaxCpeIpv4	M	RW
docsSubmgt3CpeCtrlMaxCpeIpv6Addresses	D	RW
docsSubmgt3CpeCtrlMaxCpeIpv6Prefixes	M	RW
docsSubmgt3CpeCtrlActive	M	RW
docsSubmgt3CpeCtrlLearnable	M	RW
docsSubmgt3CpeCtrlReset	M	RW
docsSubmgt3CpeCtrlLastReset	M	RW

<b>docsSubmgt3CpelpTable</b>	M	N-Acc
<b>docsSubmgt3CpelpEntry</b>	M	N-Acc
docsSubmgt3CpelpId	M	N-Acc
docsSubmgt3CpelpAddrType	M	RO
docsSubmgt3CpelpAddr	M	RO
docsSubmgt3CpelpAddrPrefixLen	M	RO
docsSubmgt3CpelpLearned	M	RO
docsSubmgt3CpelpType	M	RO
<b>docsSubmgt3GrpTable</b>	M	N-Acc
<b>docsSubmgt3GrpEntry</b>	M	N-Acc
docsSubMgt3GrpUdcGroupIds	M	RW
docsSubMgt3GrpUdcSentInRegRsp	M	RW
docsSubmgt3GrpSubFilterDs	M	RW
docsSubmgt3GrpSubFilterUs	M	RW
docsSubmgt3GrpCmFilterDs	M	RW
docsSubmgt3GrpCmFilterUs	M	RW
docsSubmgt3GrpPsFilterDs	M	RW
docsSubmgt3GrpPsFilterUs	M	RW
docsSubmgt3GrpMtaFilterDs	M	RW
docsSubmgt3GrpMtaFilterUs	M	RW
docsSubmgt3GrpStbFilterDs	M	RW
docsSubmgt3GrpStbFilterUs	M	RW
<b>docsSubmgt3FilterGrpTable</b>	M	N-Acc
<b>docsSubmgt3FilterGrpEntry</b>	M	N-Acc
docsSubmgt3FilterGrpGrpId	M	N-Acc
docsSubmgt3FilterGrpRuleId	M	N-Acc
docsSubmgt3FilterGrpAction	M	RC
docsSubmgt3FilterGrpPriority	M	RC
docsSubmgt3FilterGrpIpTosLow	M	RC
docsSubmgt3FilterGrpIpTosHigh	M	RC
docsSubmgt3FilterGrpIpTosMask	M	RC
docsSubmgt3FilterGrpIpProtocol	M	RC
docsSubmgt3FilterGrpInetAddrType	M	RC
docsSubmgt3FilterGrpInetSrcAddr	M	RC
docsSubmgt3FilterGrpInetSrcMask	M	RC
docsSubmgt3FilterGrpInetDestAddr	M	RC
docsSubmgt3FilterGrpInetDestMask	M	RC
docsSubmgt3FilterGrpSrcPortStart	M	RC
docsSubmgt3FilterGrpSrcPortEnd	M	RC
docsSubmgt3FilterGrpDestPortStart	M	RC
docsSubmgt3FilterGrpDestPortEnd	M	RC
docsSubmgt3FilterGrpDestMacAddr	M	RC
docsSubmgt3FilterGrpDestMacMask	M	RC
docsSubmgt3FilterGrpSrcMacAddr	M	RC

docsSubmgt3FilterGrpEnetProtocolType	M	RC
docsSubmgt3FilterGrpEnetProtocol	M	RC
docsSubmgt3FilterGrpUserPriLow	M	RC
docsSubmgt3FilterGrpUserPriHigh	M	RC
docsSubmgt3FilterGrpVlanId	M	RC
docsSubmgt3FilterGrpClassPkts	M	RO
docsSubmgt3FilterGrpFlowLabel	M	RC
docsSubmgt3FilterGrpCmInterfaceMask	M	RC
docsSubmgt3FilterGrpRowStatus	M	RC
<b>CLAB-TOPO-MIB [CLAB-TOPO-MIB]</b>		
<b>Object</b>	<b>CMTS</b>	<b>Access</b>
<b>clabTopoFiberNodeCfgTable</b>	M	N-Acc
<b>clabTopoFiberNodeCfgEntry</b>	M	N-Acc
clabTopoFiberNodeCfgNodeName	M	N-Acc
clabTopoFiberNodeCfgNodeDescr	M	RC
clabTopoFiberNodeCfgRowStatus	M	RC
<b>clabTopoChFnCfgTable</b>	M	N-Acc
<b>clabTopoChFnCfgEntry</b>	M	N-Acc
clabTopoChFnCfgNodeName	M	N-Acc
clabTopoChFnCfgChIfIndex	M	N-Acc
clabTopoChFnCfgRowStatus	M	RC
<b>DOCS-MCAST-AUTH-MIB [DOCS-MCAST-AUTH-MIB]</b>		
<b>Object</b>	<b>CMTS</b>	<b>Access</b>
<b>docsMcastAuthCtrl</b>		
docsMcastAuthCtrlEnable	M	RW
docsMcastAuthCtrlDefProfileNameList	M	RW
docsMcastAuthCtrlDefAction	M	RW
docsMcastAuthCtrlDefMaxNumSess	M	RW
<b>docsMcastAuthCmtsCmStatusTable</b>	M	N-Acc
<b>docsMcastAuthCmtsCmStatusEntry</b>	M	N-Acc
docsMcastAuthCmtsCmStatusCfgProfileNameList	M	RO
docsMcastAuthCmtsCmStatusCfgListId	M	RO
docsMcastAuthCmtsCmStatusMaxNumSess	M	RO
docsMcastAuthCmtsCmStatusCfgParamFlag	M	RO
<b>docsMcastAuthProfileSessRuleTable</b>	M	N-Acc
<b>docsMcastAuthProfileSessRuleEntry</b>	M	N-Acc
docsMcastAuthProfileSessRuleId	M	N-Acc
docsMcastAuthProfileSessRulePriority	M	RC
docsMcastAuthProfileSessRulePrefixAddrType	M	RC
docsMcastAuthProfileSessRuleSrcPrefixAddr	M	RC
docsMcastAuthProfileSessRuleSrcPrefixLen	M	RC
docsMcastAuthProfileSessRuleGrpPrefixAddr	M	RC
docsMcastAuthProfileSessRuleGrpPrefixLen	M	RC
docsMcastAuthProfileSessRuleAction	M	RC

docsMcastAuthProfileSessRuleRowStatus	M	RC
<b>docsMcastAuthStaticSessRuleTable</b>	O	N-Acc
<b>docsMcastAuthStaticSessRuleEntry</b>	O	N-Acc
docsMcastAuthStaticSessRuleCfgListId	O	N-Acc
docsMcastAuthStaticSessRuleId	O	N-Acc
docsMcastAuthStaticSessRulePriority	O	RO
docsMcastAuthStaticSessRulePrefixAddrType	O	RO
docsMcastAuthStaticSessRuleSrcPrefixAddr	O	RO
docsMcastAuthStaticSessRuleSrcPrefixLen	O	RO
docsMcastAuthStaticSessRuleGrpPrefixAddr	O	RO
docsMcastAuthStaticSessRuleGrpPrefixLen	O	RO
docsMcastAuthStaticSessRuleAction	O	RO
<b>docsMcastAuthProfilesTable</b>	M	N-Acc
<b>docsMcastAuthProfilesEntry</b>	M	N-Acc
docsMcastAuthProfilesName	M	N-Acc
docsMcastAuthProfilesDescription	M	RC
docsMcastAuthProfilesRowStatus	M	RC
<b>DOCS-MCAST-MIB [DOCS-MCAST-MIB]</b>		
<b>Object</b>	<b>CMTS</b>	<b>Access</b>
<b>docsMcastCmtsGrpCfgTable</b>	M	N-Acc
<b>docsMcastCmtsGrpCfgEntry</b>	M	N-Acc
docsMcastCmtsGrpCfgId	M	N-Acc
docsMcastCmtsGrpCfgRulePriority	M	RC
docsMcastCmtsGrpCfgPrefixAddrType	M	RC
docsMcastCmtsGrpCfgSrcPrefixAddr	M	RC
docsMcastCmtsGrpCfgSrcPrefixLen	M	RC
docsMcastCmtsGrpCfgGrpPrefixAddr	M	RC
docsMcastCmtsGrpCfgGrpPrefixLen	M	RC
docsMcastCmtsGrpCfgTosLow	M	RC
docsMcastCmtsGrpCfgTosHigh	M	RC
docsMcastCmtsGrpCfgTosMask	M	RC
docsMcastCmtsGrpCfgQosConfigId	M	RC
docsMcastCmtsGrpCfgEncryptConfigId	M	RC
docsMcastCmtsGrpCfgPhsConfigId	D	RC
docsMcastCmtsGrpCfgRowStatus	M	RC
<b>docsMcastCmtsGrpEncryptCfgTable</b>	M	N-Acc
<b>docsMcastCmtsGrpEncryptCfgEntry</b>	M	N-Acc
docsMcastCmtsGrpEncryptCfgId	M	N-Acc
docsMcastCmtsGrpEncryptCfgCtrl	M	RC
docsMcastCmtsGrpEncryptCfgAlg	M	RC
docsMcastCmtsGrpEncryptCfgRowStatus	M	RC
<b>docsMcastCmtsGrpPhsCfgTable</b>	D	N-Acc
<b>docsMcastCmtsGrpPhsCfgEntry</b>	D	N-Acc
docsMcastCmtsGrpPhsCfgId	D	N-Acc

docsMcastCmtsGrpPhsCfgPhsField	D	RC
docsMcastCmtsGrpPhsCfgPhsMask	D	RC
docsMcastCmtsGrpPhsCfgPhsSize	D	RC
docsMcastCmtsGrpPhsCfgPhsVerify	D	RC
docsMcastCmtsGrpPhsCfgRowStatus	D	RC
<b>docsMcastCmtsGrpQosCfgTable</b>	M	N-Acc
<b>docsMcastCmtsGrpQosCfgEntry</b>	M	N-Acc
docsMcastCmtsGrpQosCfgId	M	N-Acc
docsMcastCmtsGrpQosCfgServiceClassName	M	RC
docsMcastCmtsGrpQosCfgQosCtrl	M	RC
docsMcastCmtsGrpQosCfgAggSessLimit	M	RC
docsMcastCmtsGrpQosCfgAppld	M	RC
docsMcastCmtsGrpQosCfgRowStatus	M	RC
<b>docsMcastCmtsReplSessTable</b>	M	N-Acc
<b>docsMcastCmtsReplSessEntry</b>	M	N-Acc
docsMcastCmtsReplSessPrefixAddrType	M	N-Acc
docsMcastCmtsReplSessGrpPrefix	M	N-Acc
docsMcastCmtsReplSessSrcPrefix	M	N-Acc
docsMcastCmtsReplSessMdlfIndex	M	N-Acc
docsMcastCmtsReplSessDcsId	M	N-Acc
docsMcastCmtsReplSessServiceFlowId	M	N-Acc
docsMcastCmtsReplSessDsid	M	RO
docsMcastCmtsReplSessSaid	M	RO
<b>docsMcastDefGrpSvcClass</b>		
docsMcastDefGrpSvcClassDef	M	RW
<b>docsMcastDsidPhsTable</b>	D	N-Acc
<b>docsMcastDsidPhsEntry</b>	D	N-Acc
docsMcastDsidPhsDsid	D	N-Acc
docsMcastDsidPhsPhsField	D	RO
docsMcastDsidPhsPhsMask	D	RO
docsMcastDsidPhsPhsSize	D	RO
docsMcastDsidPhsPhsVerify	D	RO
<b>docsMcastStatsTable</b>	M	N-Acc
<b>docsMcastStatsEntry</b>	M	N-Acc
docsMcastStatsGrpAddrType	M	N-Acc
docsMcastStatsGrpAddr	M	N-Acc
docsMcastStatsGrpPrefixLen	M	N-Acc
docsMcastStatsSrcAddrType	M	N-Acc
docsMcastStatsSrcAddr	M	N-Acc
docsMcastStatsSrcPrefixLen	M	N-Acc
docsMcastStatsDroppedPkts	M	RO
docsMcastStatsDroppedOctets	M	RO
<b>docsMcastCpeListTable</b>	M	N-Acc
<b>docsMcastCpeListEntry</b>	M	N-Acc

docsMcastCpeListGrpAddrType	M	N-Acc
docsMcastCpeListGrpAddr	M	N-Acc
docsMcastCpeListGrpPrefixLen	M	N-Acc
docsMcastCpeListSrcAddrType	M	N-Acc
docsMcastCpeListSrcAddr	M	N-Acc
docsMcastCpeListSrcPrefixLen	M	N-Acc
docsMcastCpeListCmMacAddr	M	N-Acc
docsMcastCpeListDsid	M	RO
docsMcastCpeListCpeMacAddr	M	RO
docsMcastCpeListCpelpAddrType	M	RO
docsMcastCpeListCpelpAddr	M	RO
<b>docsMcastBandwidthTable</b>	M	N-Acc
<b>docsMcastBandwidthEntry</b>	M	N-Acc
docsMcastBandwidthAdmittedAggrBW	M	RO
docsMcastBandwidthAdmittedAggrLowWater	M	RO
docsMcastBandwidthAdmittedAggrHighWater	M	RO
<b>DOCS-SEC-MIB [DOCS-SEC-MIB]</b>		
<b>Object</b>	<b>CMTS</b>	<b>Access</b>
<b>docsSecCmtsCertRevocationList</b>		
docsSecCmtsCertRevocationListUrl	M	RW
docsSecCmtsCertRevocationListRefreshInterval	M	RW
docsSecCmtsCertRevocationListLastUpdate	M	RO
<b>docsSecCmtsOnlineCertStatusProtocol</b>		
docsSecCmtsOnlineCertStatusProtocolUrl	M	RW
docsSecCmtsOnlineCertStatusProtocolSignatureBypass	M	RW
<b>docsSecCmtsServerCfg</b>		
docsSecCmtsServerCfgTftpOptions	M	RW
docsSecCmtsServerCfgConfigFileLearningEnable	M	RW
<b>docsSecCmtsEncrypt</b>		
docsSecCmtsEncryptEncryptAlgPriority	M	RW
<b>docsSecCmtsSavControl</b>		
docsSecCmtsSavControlCmAuthEnable	M	RW
<b>docsSecCmtsCmEaeExclusionTable</b>	M	N-Acc
<b>docsSecCmtsCmEaeExclusionEntry</b>	M	N-Acc
docsSecCmtsCmEaeExclusionId	M	N-Acc
docsSecCmtsCmEaeExclusionMacAddr	M	RC
docsSecCmtsCmEaeExclusionMacAddrMask	M	RC
docsSecCmtsCmEaeExclusionRowStatus	M	RC
<b>docsSecSavCmAuthTable</b>	M	N-Acc
<b>docsSecSavCmAuthEntry</b>	M	N-Acc
docsSecSavCmAuthGrpName	M	RO
docsSecSavCmAuthStaticPrefixListId	M	RO
<b>docsSecSavCfgListTable</b>	M	N-Acc
<b>docsSecSavCfgListEntry</b>	M	N-Acc



docsSecSavCfgListName	M	N-Acc
docsSecSavCfgListRuleId	M	N-Acc
docsSecSavCfgListPrefixAddrType	M	RC
docsSecSavCfgListPrefixAddr	M	RC
docsSecSavCfgListPrefixLen	M	RC
docsSecSavCfgListRowStatus	M	RC
<b>docsSecSavStaticListTable</b>	M	N-Acc
<b>docsSecSavStaticListEntry</b>	M	N-Acc
docsSecSavStaticListId	M	N-Acc
docsSecSavStaticListRuleId	M	N-Acc
docsSecSavStaticListPrefixAddrType	M	RO
docsSecSavStaticListPrefixAddr	M	RO
docsSecSavStaticListPrefixLen	M	RO
<b>docsSecCmtsCmSavStatsTable</b>	M	N-Acc
<b>docsSecCmtsCmSavStatsEntry</b>	M	N-Acc
docsSecCmtsCmSavStatsSavDiscards	M	RO
<b>docsSecCmtsCertificate</b>		
docsSecCmtsCertificateCertRevocationMethod	M	RW
<b>docsSecCmtsCmBpi2EnforceExclusionTable</b>	M	N-Acc
<b>docsSecCmtsCmBpi2EnforceExclusionEntry</b>	M	N-Acc
docsSecCmtsCmBpi2EnforceExclusionMacAddr	M	N-Acc
docsSecCmtsCmBpi2EnforceExclusionTable	M	RC
docsSecCmtsCmBpi2EnforceExclusionMacAddrMask	M	RC
docsSecCmtsCmBpi2EnforceExclusionRowStatus	M	RC
<b>IPMCAST-MIB [RFC 5132]</b>		
Object	CMTS	Access
ipMcast Group		
ipMcastEnabled	M	RO
ipMcastRouteEntryCount	M	RO
<b>ipMcastRouteTable</b>	M	N-Acc
<b>ipMcastRouteEntry</b>	M	N-Acc
ipMcastRouteGroupAddressType	M	N-Acc
ipMcastRouteGroup	M	N-Acc
ipMcastRouteGroupPrefixLength	M	N-Acc
ipMcastRouteSourceAddressType	M	N-Acc
ipMcastRouteSource	M	N-Acc
ipMcastRouteSourcePrefixLength	M	N-Acc
ipMcastRouteUpstreamNeighborType	M	RO
ipMcastRouteUpstreamNeighbor	M	RO
ipMcastRouteInIfIndex	M	RO
ipMcastRouteTimeStamp	M	RO
ipMcastRouteExpiryTime	M	RO
ipMcastRouteProtocol	M	RO
ipMcastRouteRtProtocol	M	RO

ipMcastRouteRtAddressType	M	RO
ipMcastRouteRtPrefixLength	M	RO
ipMcastRouteRtType	M	RO
ipMcastRouteOctets	M	RO
ipMcastRoutePkts	M	RO
ipMcastRouteTtlDropOctets	M	RO
ipMcastRouteTtlDropPackets	M	RO
ipMcastRouteDifferentInIfOctets	M	RO
ipMcastRouteDifferentInIfPackets	M	RO
ipMcastRouteBps	M	RO

## A.2 CCAP-MIB Object Details

The table below lists the CCAP compliance requirements summary.

CCAP-MIB [CCAP-MIB]		
ccapInterfaceIndexMapTable		
Objects	Requirement	Access
ccapInterfaceIndexMapEntry	M	N-Acc
ccapInterfaceIndexMapPath	M	RO
ccapInterfaceIndexMapEntPhysicalIndex	M	RO
ccapMpegInputProgTable		
Objects	Requirement	Access
ccapMpegInputProgEntry	M	N-Acc
ccapMpegInputProgBitRate	M	RO
ccapMpegInputProgRequestedBandwidth	M	RO
ccapMpegOutputProgTable		
Objects	Requirement	Access
ccapMpegOutputProgEntry	M	N-Acc
ccapMpegOutputProgBitRate	M	RO
ccapMpegInputProgVideoSessionTable		
Objects	Requirement	Access
ccapMpegInputProgVideoSessionEntry	M	N-Acc
ccapMpegInputProgVideoSessionStatus	M	RO
ccapMpegOutputProgVideoSessionTable		
Objects	Requirement	Access
ccapMpegOutputProgVideoSessionEntry	M	N-Acc
ccapMpegOutputProgVideoSessionStatus	M	RO
ccapEcmgStatusTable		
Objects	Requirement	Access
ccapEcmgStatusEntry	M	N-Acc
ccapEcmgIndex	M	N-Acc
ccapEcmgNumActiveSessions	M	RO

CCAP-MIB [CCAP-MIB]		
ccapEcmsgCwMessageCount	M	RO
ccapEcmdStatusTable		
Objects	Requirement	Access
ccapEcmdStatusEntry	M	N-Acc
ccapEcmdIndex	M	N-Acc
ccapEcmdNumActiveSessions	M	RO
ccapEcmdCwMessageCount	M	RO
ccapMpegDecryptSessionTable		
Objects	Requirement	Access
ccapMpegDecryptSessionEntry	M	N-Acc
ccapMpegDecryptSessionDecrypted =	M	RO

### A.3 HMS-MIB Object Details

The table below lists the CCAP compliance requirements summary.

SCTE-HMS-QAM-MIB [SCTE 154-2]		
qamChannelTable		
Objects	Requirement	Access
qamChannelFrequency	M	RO
qamChannelModulationFormat	M	RO
qamChannelInterleaverLevel	M	RO
qamChannelInterleaverMode	M	RO
qamChannelPower	M	RO
qamChannelSquelch	M	RO
qamChannelContWaveMode	M	RO
qamChannelAnnexMode	M	RO
qamChannelCommonTable		
Objects	Requirement	Access
qamChannelCommonOutputBw	M	RO
qamChannelCommonUtilization	M	RO
qamConfigTable		
Objects	Requirement	Access
qamConfigIndex	M	N-Acc
qamConfigQamChannelIdMin	M	RO
qamConfigQamChannelIdMax	M	RO
qamConfigIPAddrType	M	RO
qamConfigIPAddr	M	RO

<b>SCTE-HMS-QAM-MIB [SCTE 154-2]</b>		
qamConfigUdpPortRangeMin	M	RO
qamConfigUdpPortRangeMax	M	RO
qamConfigOutputProgNoMin	M	RO
qamConfigOutputProgNoMax	M	RO
<b>SCTE-HMS-MPEG-MIB [SCTE 154-4]</b>		
mpegDigitalInputs		
Object	Requirement	Access
mpegLossOfSignalTimeout	M	RO
mpegInputTSTable		
Objects	Requirement	Access
mpegInputTSIndex	M	N-Acc
mpegInputTSType	M	RO
mpegInputTSConnectionType	M	RO
mpegInputTSConnection	M	RO
mpegInputTSActiveConnection	M	RO
mpegInputTSPsiDetected	M	RO
mpegInputTSStartTime	M	RO
mpegInputTSResourceAllocated	M	RO
mpegInputTSNumPrograms	M	RO
mpegInputTSRate	M	RO
mpegInputTSMaxRate	M	RO
mpegInputTSPatVersion	M	RO
mpegInputTSCatVersion	M	RO
mpegInputTSNitPid	M	RO
mpegInputTSNumEmms	M	RO
mpegInputTSTSID	M	RO
mpegInputTSLock	O	RO
mpegInputProgTable		
Objects	Requirement	Access
mpegInputProgIndex	M	N-Acc
mpegInputProgNo	M	RO
mpegInputProgPmtVersion	M	RO
mpegInputProgPmtPid	M	RO
mpegInputProgPcrPid	M	RO
mpegInputProgEcmPid	M	RO
mpegInputProgNumElems	M	RO
mpegInputProgNumEcms	M	RO

<b>SCTE-HMS-QAM-MIB [SCTE 154-2]</b>		
mpegInputProgCaDescr	M	RO
mpegInputProgScte35Descr	O	RO
mpegInputProgScte18Descr	O	RO
mpegProgESTable		
<b>Objects</b>	<b>Requirement</b>	<b>Access</b>
mpegProgESIndex	M	N-Acc
mpegProgESPID	M	RO
mpegProgESType	M	RO
mpegProgESCaDescr	M	RO
mpegProgESScte35Descr	O	RO
mpegProgESScte18Descr	O	RO
mpegInputStatsTable		
<b>Objects</b>	<b>Requirement</b>	<b>Access</b>
mpegInputStatsPcrJitter	M	RO
mpegInputStatsMaxPacketJitter	M	RO
mpegInputStatsPcrPackets	M	RO
mpegInputStatsNonPcrPackets	M	RO
mpegInputStatsUnexpectedPackets	M	RO
mpegInputStatsContinuityErrors	M	RO
mpegInputStatsSyncLossPackets	M	RO
mpegInputStatsPcrIntervalExceeds	M	RO
mpegInputUdpOriginationTable		
<b>Objects</b>	<b>Requirement</b>	<b>Access</b>
mpegInputUdpOriginationIndex	M	N-Acc
mpegInputUdpOriginationId	M	N-Acc
mpegInputUdpOriginationIfIndex	M	RO
mpegInputUdpOriginationInetAddrType	M	RO
mpegInputUdpOriginationSrcInetAddr	M	RO
mpegInputUdpOriginationDestInetAddr	M	RO
mpegInputUdpOriginationDestPort	M	RO
mpegInputUdpOriginationActive	M	RO
mpegInputUdpOriginationPacketsDetected	M	RO
mpegInputUdpOriginationRank	M	RO
mpegInputUdpOriginationInputTSIndex	M	RO

<b>SCTE-HMS-QAM-MIB [SCTE 154-2]</b>		
mpegInsertPacketTable		
<b>Objects</b>	<b>Requirement</b>	<b>Access</b>
mpegInsertPacketIndex	M	N-Acc
mpegInsertPacketListId	M	RO
mpegInsertPacketImmediateExecution	M	RO
mpegInsertPacketStartTime	M	RO
mpegInsertPacketRepeat	M	RO
mpegInsertPacketContinuousFlag	M	RO
mpegInsertPacketRate	M	RO
mpegInsertPacketDeviceIndex	M	RO
mpegOutputStatsTable		
<b>Objects</b>	<b>Requirement</b>	<b>Access</b>
mpegOutputStatsDroppedPackets	M	RO
mpegOutputStatsFifoOverflow	M	RO
mpegOutputStatsFifoUnderflow	M	RO
mpegOutputStatsDataRate	M	RO
mpegOutputStatsAvailableBandwidth	M	RO
mpegOutputStatsChannelUtilization	M	RO
mpegOutputStatsTotalPackets	M	RO
mpegOutputTSTable		
<b>Objects</b>	<b>Requirement</b>	<b>Access</b>
mpegOutputTSIndex	M	N-Acc
mpegOutputTSType	M	RO
mpegOutputTSConnectionType	M	RO
mpegOutputTSConnection	M	RO
mpegOutputTSNumPrograms	M	RO
mpegOutputTSTSID	M	RO
mpegOutputTSNitPid	M	RO
mpegOutputTSCaPid	M	RO
mpegOutputTSCatInsertRate	M	RO
mpegOutputTSPatInsertRate	M	RO
mpegOutputTSPmtInsertRate	M	RO
mpegOutputTSStartTime	M	RO

<b>SCTE-HMS-QAM-MIB [SCTE 154-2]</b>		
mpegOutputProgTable		
<b>Objects</b>	<b>Requirement</b>	<b>Access</b>
mpegOutputProgIndex	M	N-Acc
mpegOutputProgNo	M	RO
mpegOutputProgPmtVersion	M	RO
mpegOutputProgPmtPid	M	RO
mpegOutputProgPcrPid	M	RO
mpegOutputProgEcmPid	M	RO
mpegOutputProgNumElems	M	RO
mpegOutputProgNumEcms	M	RO
mpegOutputProgCaDescr	M	RO
mpegOutputProgScte35Descr	O	RO
mpegOutputProgScte18Descr	O	RO
mpegOutputProgElemStatsTable		
<b>Objects</b>	<b>Requirement</b>	<b>Access</b>
mpegOutputProgElemStatsIndex	M	N-Acc
mpegOutputProgElemStatsPid	M	RO
mpegOutputProgElemStatsElemType	M	RO
mpegOutputProgElemStatsDataRate	O	RO
mpegOutputUdpDestinationTable		
<b>Objects</b>	<b>Requirement</b>	<b>Access</b>
mpegOutputUdpDestinationIndex	NA	
mpegOutputUdpDestinationId	NA	
mpegOutputUdpDestinationIfIndex	NA	
mpegOutputUdpDestinationInetAddrType	NA	
mpegOutputUdpDestinationSrcInetAddr	NA	
mpegOutputUdpDestinationDestInetAddr	NA	
mpegOutputUdpDestinationDestPort	NA	
mpegOutputUdpDestinationOutputTSIndex	NA	
mpegProgramMappingTable		
<b>Objects</b>	<b>Requirement</b>	<b>Access</b>
mpegProgramMappingIndex	M	N-Acc
mpegProgramMappingOutputProgIndex	M	RO
mpegProgramMappingOutputTSIndex	M	RO
mpegProgramMappingInputProgIndex	M	RO
mpegProgramMappingInputTSIndex	M	RO

<b>SCTE-HMS-QAM-MIB [SCTE 154-2]</b>		
<b>mpegVideoSessionTable</b>		
<b>Objects</b>	<b>Requirement</b>	<b>Access</b>
mpegVideoSessionIndex	M	N-Acc
mpegVideoSessionPhyMappingIndex	M	RO
mpegVideoSessionPIDRemap	M	RO
mpegVideoSessionMode	M	RO
mpegVideoSessionState	M	RO
mpegVideoSessionProvMethod	M	RO
mpegVideoSessionEncryptionType	M	RO
mpegVideoSessionEncryptionInfo	M	RO
mpegVideoSessionBitRate	M	RO
mpegVideoSessionID	M	RO
mpegVideoSessionSelectedInput	M	RO
mpegVideoSessionSelectedOutput	M	RO
<b>mpegVideoSessionPtrTable</b>		
<b>Objects</b>	<b>Requirement</b>	<b>Access</b>
mpegVideoSessionPtrInputProgIndex	M	N-Acc
mpegVideoSessionPtrInputTSIndex	M	RO
mpegVideoSessionPtrInputTSConnType	M	RO
mpegVideoSessionPtrInputTSConnection	M	RO
mpegVideoSessionPtrOutputProgIndex	M	RO
mpegVideoSessionPtrOutputTSIndex	M	RO
mpegVideoSessionPtrOutputTSConnType	M	RO
mpegVideoSessionPtrOutputTSConnection	M	RO
mpegVideoSessionPtrStatus	M	RO
<b>mpegInputTSOutputSessionTable</b>		
<b>Objects</b>	<b>Requirement</b>	<b>Access</b>
mpegInputTSOutputSessionCreateTime	M	RO

#### A.4 PNM MIB Object Details<sup>229</sup>

The table below lists the CCAP compliance requirements summary.

<b>DOCS-PNM-MIB</b>		
<b>Object</b>	<b>CMTS</b>	<b>Access</b>
<b>docsPnmBulkCtl Group</b>		
docsPnmBulkDestIpAddrType	M	RW

<sup>229</sup> Modified per CCAP-OSSv3.1-N-16.1510-2 on 5/16/16 by KB; per CCAP-OSSv3.1-N-16.1546-1 on 11/16/16 by KB; per CCAP-OSSv3.1-N-16.1631-5 on 12/9/16 by KB.



docsPnmBulkDestIpAddr	M	RW
docsPnmBulkDestPath	M	RW
docsPnmBulkUploadControl	M	RW
<b>docsPnmBulkFileTable</b>	M	N-Acc
<b>docsPnmBulkFileEntry</b>	M	N-Acc
docsPnmBulkFileIndex	M	N-Acc
docsPnmBulkFileName	M	RO
docsPnmBulkFileControl	M	RW
docsPnmBulkFileUploadStatus	M	RO
<b>docsPnmCmtsDsOfdmSymCapTable</b>	M	N-Acc
<b>docsPnmCmtsDsOfdmSymCapEntry</b>	M	N-Acc
docsPnmCmtsDsOfdmSymTrigEnable	M	RW
docsPnmCmtsDsOfdmSymTrigGroupId	M	RW
docsPnmCmtsDsOfdmSymCaptFileName	M	RW
docsPnmCmtsDsOfdmSymMeasStatus	M	RO
docsPnmCmtsDsOfdmSymFirstActSubCarIdx	M	RO
docsPnmCmtsDsOfdmSymLastActSubCarIdx	M	RO
docsPnmCmtsDsOfdmSymRxWindowing	M	RO
docsPnmCmtsDsOfdmSymTransactionId	M	RO
docsPnmCmtsDsOfdmSymSampleRate	M	RO
docsPnmCmtsDsOfdmSymFftLength	M	RO
<b>docsPnmCmtsDsOfdmNoisePwrRatioTable</b>	M	N-Acc
<b>docsPnmCmtsDsOfdmNoisePwrRatioEntry</b>	M	N-Acc
docsPnmCmtsDsOfdmNprStartSubcar	M	RW
docsPnmCmtsDsOfdmNprStopSubcar	M	RW
docsPnmCmtsDsOfdmNprEnable	M	RW
docsPnmCmtsDsOfdmNprDuration	M	RW
<b>docsPnmCmtsUsOfdmaAQProbeTable</b>	M	N-Acc
<b>docsPnmCmtsUsOfdmaAQProbeEntry</b>	M	N-Acc
docsPnmCmtsUsOfdmaAQProbeCmMacAddr	M	RW
docsPnmCmtsUsOfdmaAQProbeUseIdleSid	M	RW
docsPnmCmtsUsOfdmaAQProbePreEqOn	M	RW
docsPnmCmtsUsOfdmaAQProbeEnable	M	RW
docsPnmCmtsUsOfdmaAQProbeTimeout	M	RW
docsPnmCmtsUsOfdmaAQProbeNumSymToCapt	M	RW
docsPnmCmtsUsOfdmaAQProbeMaxCaptSymbols	M	RO
docsPnmCmtsUsOfdmaAQProbeNumSamples	M	RO
docsPnmCmtsUsOfdmaAQProbeTimeStamp	M	RO
docsPnmCmtsUsOfdmaAQProbeMeasStatus	M	RO
docsPnmCmtsUsOfdmaAQProbeFileName	M	RW
<b>docsPnmCmtsUsImpNoiseTable</b>	M	N-Acc
<b>docsPnmCmtsUsImpNoiseEntry</b>	M	N-Acc
docsPnmCmtsUsImpNoiseEnable	M	RW
docsPnmCmtsUsImpNoiseFreeRunDuration	M	RW

docsPnmCmtsUsImpNoiseStTrigLvl	M	RW
docsPnmCmtsUsImpNoiseEndTrigLvl	M	RW
docsPnmCmtsUsImpNoiseCenterFrq	M	RW
docsPnmCmtsUsImpNoiseMeasBw	M	RW
docsPnmCmtsUsImpNoiseNumEvtsCnted	M	RO
docsPnmCmtsUsImpNoiseLastEvtTimeStamp	M	RO
docsPnmCmtsUsImpNoiseLastEvtDuration	M	RO
docsPnmCmtsUsImpNoiseLastEvtAvgPwr	M	RO
docsPnmCmtsUsImpNoiseMeasStatus	M	RO
docsPnmCmtsUsImpNoiseFileName	M	RW
<b>docsPnmCmtsUsHistTable</b>	M	N-Acc
<b>docsPnmCmtsUsHistEntry</b>	M	N-Acc
docsPnmCmtsUsHistEnable	M	RW
docsPnmCmtsUsHistTimeOut	M	RW
docsPnmCmtsUsHistMeasStatus	M	RO
docsPnmCmtsUsHistFileName	M	RW
<b>docsPnmCmtsUsOfdmaRxPwrTable</b>	M	N-Acc
<b>docsPnmCmtsUsOfdmaRxPwrEntry</b>	M	N-Acc
docsPnmCmtsUsOfdmaRxPwrEnable	M	RW
docsPnmCmtsUsOfdmaRxPwrCmMac	M	N-Acc
docsPnmCmtsUsOfdmaRxPwrPreEq	M	RW
docsPnmCmtsUsOfdmaRxPwrNumAvg	M	RW
docsPnmCmtsUsOfdmaRxPwrOnePtSixPsd	M	RO
docsPnmCmtsUsOfdmaRxPwrMeasStatus	M	RO
<b>docsPnmCmtsUsOfdmaRxMerTable</b>	M	N-Acc
<b>docsPnmCmtsUsOfdmaRxMerEntry</b>	M	N-Acc
docsPnmCmtsUsOfdmaRxMerEnable	M	RW
docsPnmCmtsUsOfdmaRxMerCmMac	M	RW
docsPnmCmtsUsOfdmaRxMerPreEq	M	RW
docsPnmCmtsUsOfdmaRxMerNumAvg	M	RW
docsPnmCmtsUsOfdmaRxMerMeasStatus	M	RO
docsPnmCmtsUsOfdmaRxMerFileName	M	RW
<b>docsPnmCmtsUsSpecAnTable</b>	M	N-Acc
<b>docsPnmCmtsUsSpecAnEntry</b>	M	N-Acc
docsPnmCmtsUsSpecAnEnable	M	RW
docsPnmCmtsUsSpecAnTrigMode	M	RW
docsPnmCmtsUsSpecAnMiniSlotCnt	M	RW
docsPnmCmtsUsSpecAnSid	M	RW
docsPnmCmtsUsSpecAnMiniSlotNum	M	RW
docsPnmCmtsUsSpecAnCmMac	M	RW
docsPnmCmtsUsSpecAnCenterFreq	M	RW
docsPnmCmtsUsSpecAnSpan	M	RW
docsPnmCmtsUsSpecAnNumberOfBins	M	RW
docsPnmCmtsUsSpecAnMeasStatus	M	RO

docsPnmCmtsUsSpecAnFileName	M	RW
<b>docsPnmCmtsOptReqTable</b>	M	N-Acc
<b>docsPnmCmtsOptReqEntry</b>	M	N-Acc
docsPnmCmtsOptReqCmMacAddr	M	N-Acc
docsPnmCmtsOptReqDsOfdmChanCfgIndex	M	N-Acc
docsPnmCmtsOptReqDsOfdmProfCfgId	M	N-Acc
docsPnmCmtsOptReqOpCode	M	RC
docsPnmCmtsOptReqProfileTest	M	RC
docsPnmCmtsOptReqMaxDuration	M	RC
docsPnmCmtsOptReqMaxCodewords	M	RC
docsPnmCmtsOptReqMaxUncorrectableCws	M	RC
docsPnmCmtsOptReqCwTaggingEnabled	M	RC
docsPnmCmtsOptReqNcpFields	M	RC
docsPnmCmtsOptReqMaxNcpCrcFails	M	RC
docsPnmCmtsOptReqStatus	M	RC
<b>docsPnmCmtsOptMerThreshCfgTable</b>	M	N-Acc
<b>DocsPnmCmtsOptMerThreshCfgEntry</b>	M	N-Acc
docsPnmCmtsOptMerThreshCfgModOrder	M	N-Acc
docsPnmCmtsOptMerThreshCfgRxMerVsBitloadingTarget	M	RC
docsPnmCmtsOptMerThreshCfgRxMerMargin	M	RC
docsPnmCmtsOptMerThreshCfgStatus	M	RC
<b>docsPnmCmtsOptProfChgCfgTable</b>	O	N-Acc
<b>docsPnmCmtsOptProfChgCfgEntry</b>	O	N-Acc
docsPnmCmtsOptProfChgCfgIdxIndex	O	N-Acc
docsPnmCmtsOptProfChgCfgDsProfList	O	RC
docsPnmCmtsOptProfChgCfgStatus	O	RC
<b>docsPnmCmtsOptRespTable</b>	M	N-Acc
<b>docsPnmCmtsOptRespEntry</b>	M	N-Acc
docsPnmCmtsOptRespStatus	M	RO
docsPnmCmtsOptRespFirstActiveSubcarrierNum	M	RO
docsPnmCmtsOptRespMerData	M	RO
docsPnmCmtsOptRespMerPassFailData	M	RO
docsPnmCmtsOptRespNumSubcarriersBelowThresh	M	RO
docsPnmCmtsOptRespSnrMarginData	M	RO
docsPnmCmtsOptRespCodewordCt	M	RO
docsPnmCmtsOptRespCorrectedCodewordCt	M	RO
docsPnmCmtsOptRespUncorrectableCodewordCt	M	RO
docsPnmCmtsOptRespNcpFieldCt	M	RO
docsPnmCmtsOptRespNcpCrcFailCt	M	RO
<b>docsPnmCmtsUtscCapabTable</b>	M	N-Acc
<b>docsPnmCmtsUtscCapabEntry</b>	M	N-Acc
docsPnmCmtsUtscCapabTriggerMode	M	RO
docsPnmCmtsUtscCapabOutputFormat	M	RO
docsPnmCmtsUtscCapabWindow	M	RO

docsPnmCmtsUtscCapabDescription	M	RO
<b>docsPnmCmtsUtscCfgTable</b>	M	N-Acc
<b>docsPnmCmtsUtscCfgEntry</b>	M	N-Acc
docsPnmCmtsUtscCfgIndex	M	N-Acc
docsPnmCmtsUtscCfgLogicalChlflIndex	M	RW
docsPnmCmtsUtscCfgTriggerMode	M	RW
docsPnmCmtsUtscCfgMinislotCount	M	RW
docsPnmCmtsUtscCfgSid	M	RW
docsPnmCmtsUtscCfgCmMacAddr	M	RW
docsPnmCmtsUtscCfgTimestamp	M	RW
docsPnmCmtsUtscCfgCenterFreq	M	RW
docsPnmCmtsUtscCfgSpan	M	RW
docsPnmCmtsUtscCfgNumBins	M	RW
docsPnmCmtsUtscCfgAveraging	M	RW
docsPnmCmtsUtscCfgFilename	M	RW
docsPnmCmtsUtscCfgQualifyCenterFreq	M	RW
docsPnmCmtsUtscCfgQualifyBw	M	RW
docsPnmCmtsUtscCfgQualifyThrshld	M	RW
docsPnmCmtsUtscCfgWindow	M	RW
docsPnmCmtsUtscCfgOutputFormat	M	RW
docsPnmCmtsUtscCfgRepeatPeriod	M	RW
docsPnmCmtsUtscCfgFreeRunDuration	M	RW
docsPnmCmtsUtscCfgTriggerCount	M	RW
docsPnmCmtsUtscCfgStatus	M	RW
<b>docsPnmCmtsUtscCtrlTable</b>	M	N-Acc
<b>docsPnmCmtsUtscCtrlEntry</b>	M	N-Acc
docsPnmCmtsUtscCtrlInitiateTest	M	RW
<b>docsPnmCmtsUtscStatusTable</b>	M	N-Acc
<b>docsPnmCmtsUtscStatusEntry</b>	M	N-Acc
docsPnmCmtsUtscStatusMeasStatus	M	RO
<b>docsPnmCmtsUtscResultTable</b>	M	N-Acc
<b>docsPnmCmtsUtscResultEntry</b>	M	N-Acc
docsPnmCmtsUtscResultSampleRate	M	RO
docsPnmCmtsUtscResultUsSampleSize	M	RO
docsPnmCmtsUtscResultSampleTimestamp	M	RO
docsPnmCmtsUtscResultResolutionBw	M	RO
docsPnmCmtsUtscResultOutput	M	RO

## Annex B IPDR for DOCSIS Cable Data Systems Subscriber Usage Billing Records (Normative)

### B.1 Service Definition

Cable Data Systems consist of Cable Modem Termination Systems (CMTSs), located at a Multiple Service Operator's (MSO's) head-end office, that provide broadband Internet access to subscribers connected via Cable Modems (CMs), through the Hybrid Fiber/Coax (HFC) cable plant. These Cable Data Systems comply with the Data-Over-Cable Service Interface Specifications (DOCSIS) sponsored by Cable Television Laboratories, Inc. The IPDR format for Cable Data Systems Subscriber Usage Billing Records specified herein, support the DOCSIS 1.1, 2.0 and 3.0 Operations Support System Interface Specification (OSSI). The DOCSIS 1.1, 2.0 and 3.0 OSSI specifications require the CMTS to provide usage-billing records for all bandwidth consumed by the subscribers connected to it by their Cable Modems, when polled by the MSO's billing or mediation system.

#### B.1.1 DOCSIS Service Requirements<sup>230</sup>

1. Cable Data Service is "always on". Thus, from the CMTS perspective, there are no subscriber log-on events to track, but rather, in a manner similar to electric power utilities, there are only data traffic flows to meter and police.
2. Cable Data Subscribers are uniquely identified by their Cable Modem MAC addresses (i.e., Ethernet addresses). Note that a CM is usually assigned a dynamic IP address via DHCP, so the IP address of a subscriber may change over time. Since the CM MAC address is constant, it is used to identify the subscriber's usage billing records. All Internet traffic generated by the subscriber's CPE is bridged by the CM to and from the CMTS. The subscriber's packet and byte (octet) traffic counts are recorded by the CMTS in Service Flow counters associated with the CM MAC address. A CM may have two or more Service Flows active during a collection interval. Note that the current IP addresses of the CM and all the CPE in use during the collection interval are recorded for auditing purposes.
3. Cable Data Service is metered and enforced against a Service Level Agreement (SLA) that specifies the Quality of Service (QoS) that an MSO provides to a subscriber. An MSO typically has several Service Packages to offer to their subscribers, such as "Gold", "Silver", or "Bronze". Each of the Service Packages implements a specific SLA and is available for a specific price. A Service Package is implemented by a set of Service Flows that are known to the billing system by their Service Flow IDs (SFIDs) and Service Class Names (SCNs). Service Flows are the unit of billing data collection for a Cable Data Subscriber. In addition, since a subscriber may change their Service Package over time, it is very likely that a given subscriber will have several IPDRs, one for each Service Flow they have used during the collection interval.
4. Bandwidth in a Cable Data System is measured separately in both the downstream and upstream directions (relative to the CMTS). Each Service Flow is unidirectional and may be associated with packet traffic of a specific type (e.g., TCP or UDP). Since most SLAs provide for asymmetric bandwidth guarantees, it is necessary to separate the downstream and upstream traffic flows in the billing usage records. Bandwidth used is measured in both packets and octets.
5. The bandwidth guarantee component of the SLA is enforced and metered by the CMTS with the assistance of the CM. However, the CM is not considered a trusted device because of its location on the Customer's Premises, so the CMTS is expected to provide all of the usage billing information for each subscriber connected to it.
6. Since an SLA may require the CMTS to enforce bandwidth limits by dropping or delaying packets that exceed the maximum throughput bandwidth for a Service Flow, the SLA dropped packets counters and delayed packets counters are also included in the usage records for each Service Flow. These counters are not intended to compute billable subscriber usage but rather are available to the billing and customer care systems to enable "up-selling" to subscribers who consistently exceed their subscribed service level. Thus, subscribers whose usage patterns indicate a large number of dropped octets are probably candidates for an upgrade to a higher SLA that supports their true application bandwidth demands which, in turn, generates more revenue for the MSO.

---

<sup>230</sup> Revised per CCAP-OSSiv3.1-N-15.1390-2 on 11/11/15 by KB.

7. The packet and octet values in the usage billing records are based on absolute 64-bit counters maintained in the CMTS. These counters may be reset when the CMTS system resets, therefore the CMTS system up time (see CmtsSysUpTime in Annex C) is included in the IPDRDoc so that the billing or mediation system can correlate counters that appear to regress.
8. Group Service Flows are Service Flows received by one or more Cable Modems. A single record is created for a Group Service flow.

### **B.1.2 SAMIS Usage Attribute List**

A DOCSIS SAMIS IPDR record is constructed from a number of attributes that describe the IPDR itself, the CMTS that is serving the subscriber, the subscriber's CM, and the QoS attributes and counters.

#### **B.1.2.1 CMTS Information**

A DOCSIS SAMIS IPDR record contains attributes that identify the CMTS that is serving the subscriber. The CMTS attributes are defined in the CMTS Information section of Annex C. Note that the CMTS information attributes defined in Annex C can be streamed independently (i.e., in other IPDR record types) from the SAMIS IPDR and then correlated at the Collector using the CmtsHostName attribute.

DOCSIS SAMIS Type 1 IPDR records contain the following CMTS attributes:

- CmtsHostName
- CmtsSysUpTime
- CmtsIpv4Addr
- CmtsIpv6Addr
- CmtsMdIfName
- CmtsMdIfIndex

DOCSIS SAMIS Type 2 IPDR records contain the following CMTS attributes:

- CmtsHostName
- CmtsSysUpTime
- CmtsMdIfName
- CmtsMdIfIndex

#### **B.1.2.2 CM Information**

A DOCSIS SAMIS IPDR record contains attributes that uniquely identify the CM or Group Service Flow. Each SAMIS IPDR for a given CM or Group Service Flow within the IPDRDoc will contain identical values for these attributes. The CM attributes are defined in the CM or Group Service Flow Information section of Annex C. Note that the CM information attributes defined in Annex C can be streamed independently (i.e., in other IPDR record types) from the SAMIS IPDR and then correlated at the Collector.

DOCSIS SAMIS Type 1 IPDR records contain the following CM attributes:

- CmMacAddr
- CmIpv4Addr
- CmIpv6Addr
- CmIpv6LinkLocalAddr
- CmQosVersion
- CmRegStatusValue
- CmLastRegTime

DOCSIS SAMIS Type 2 IPDR records contain the following CM attribute:

- CmMacAddr

### **B.1.2.3 Record Information**

A DOCSIS SAMIS IPDR record contains attributes that identify the type of record and creation time. The Record attributes are defined in the Record Information section of Annex C.

DOCSIS SAMIS Type 1 and Type 2 IPDR records contain the following CM attributes:

- RecType
- RecCreationTime

### **B.1.2.4 QoS Information**

A DOCSIS SAMIS IPDR record contains the following attributes that identify the service flow and contain the counters maintained by the CMTS for that service flow (i.e., QoS attributes). The QoS attributes are defined in the QoS Information section of Annex C.

DOCSIS SAMIS Type 1 and Type 2 IPDR records contain the following CM attributes:

- ServiceFlowChSet
- ServiceAppId
- ServiceDsMulticast
- ServiceIdentifier
- ServiceGateId
- ServiceClassName
- ServiceDirection
- ServiceOctetsPassed
- ServicePktsPassed
- ServiceSlaDropPkts
- ServiceSlaDelayPkts
- ServiceTimeCreated
- ServiceTimeActive

## **B.2 IPDR Service Definition Schemas**

Refer to [DOCSIS-SAMIS-TYPE-1] and [DOCSIS-SAMIS-TYPE-2] for the IPDR Service Definition XML schemas for the SAMIS feature.

## Annex C Auxiliary Schemas for DOCSIS IPDR Service Definitions (Normative)

### C.1 Overview

This annex defines a set of auxiliary schema files for the DOCSIS IPDR Service Definitions defined in Section 2.1. In some cases, the auxiliary schema element definitions are derived from attributes defined in object models from other annexes within this specification. Otherwise the attributes are defined within this annex before the inclusion of the auxiliary schema file.

An auxiliary schema file defines global elements that are referenced in various DOCSIS IPDR Service Definition schemas. The purpose for defining auxiliary schemas is to allow defining global elements that can be externally referenced in multiple DOCSIS IPDR Service Definition schemas. This allows for modularization of schema documents and easier extensibility.

### C.2 XML Semantics

#### C.2.1 Import Element

DOCSIS IPDR Service Definition schemas are often composed from multiple schema documents (called auxiliary schemas). This is accomplished through the import mechanism since the Service Definition schema and auxiliary schemas have different namespaces.

Auxiliary schemas are imported in any one of the DOCSIS IPDR Service Definition schemas using the import element as follows:

```
<import namespace="<Auxiliary Schema Namespace>" schemaLocation="<Auxiliary Schema Location>" />
```

The import element appears at the top level of the Service Definition schema document. Figure C-1 shows an example of the import mechanism.

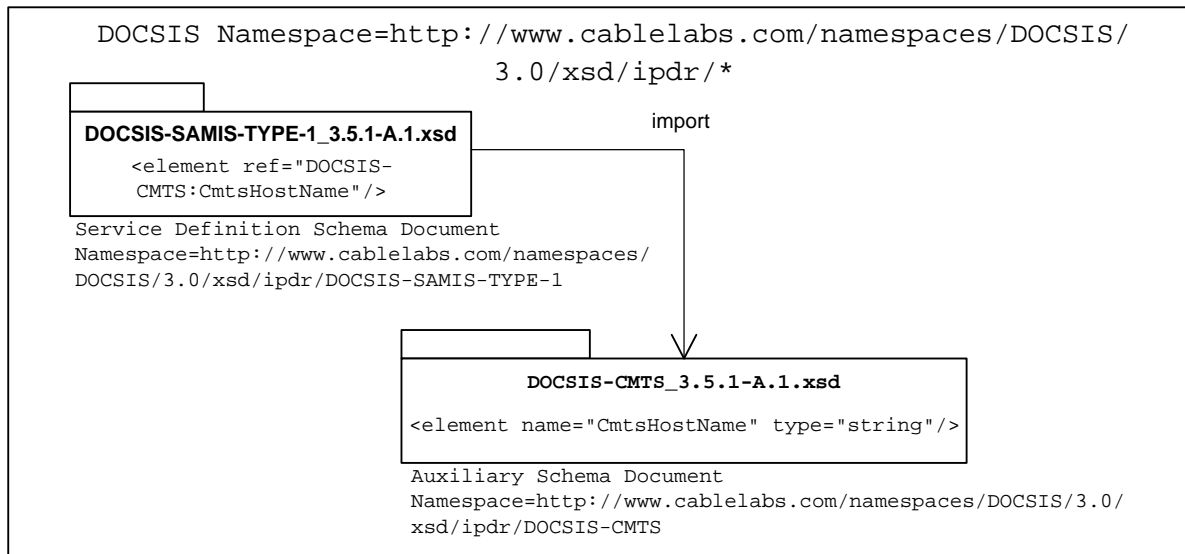

**Figure C-1 - Auxiliary Schema Import**

#### C.2.2 Element References

In many instances, an object model defines a group of objects where each object defines a set of attributes. Attributes are then realized in XML schemas as element definitions (not XML attribute definitions). Therefore the terms 'attribute' and 'element' are often interchangeable). It should be clarified that object model attributes (as



defined in this specification) are not the same as XML attributes (as often used in XML Schemas). IPDR schemas do not define XML attributes.

DOCSIS IPDR Service Definition schema documents reference global element declarations from auxiliary schemas using a ref attribute. For example, a Service Definition schema references the CmtsHostName global element using the ref attribute as follows:

```
<element ref="DOCSIS-CMTS:CmtsHostName"/>
```

Figure C-1 shows the CmtsHostName global element declaration in the auxiliary schema DOCSIS-CMTS\_3.5.1-A.1.xsd and the element reference in the Service Definition schema DOCSIS-SAMIS-TYPE-1\_3.5.1-A.1.xsd.

### C.3 CMTS Information

The DOCSIS CMTS Information auxiliary schema contains the following attributes that identify a CMTS.

**Table C-1 - CMTS Information Attributes**

Category	Attribute Name	Type	Presence	Permitted Values
Who	CmtsHostName	String	Required	FQDN
When	CmtsSysUpTime	unsignedInt	Required	nnnnnnnnn
Who	CmtsIpv4Addr	ipV4Addr	Required	nnn.nnn.nnn.nnn
Who	CmtsIpv6Addr	ipV6Addr	Required	xxxx:xxxx:xxxx:xxxx:xxxx:xxxx:xxxx:xxxx
What	CmtsMdlfName	String	Required	SIZE (0..50)
What	CmtsMdlfIndex	unsignedInt	Required	nnnnnnnnn

#### C.3.1 CmtsHostName

CmtsHostName is the fully qualified domain name (FQDN) of the CMTS. This attribute will contain an empty string only if the CMTS does not have a domain name. A null FQDN will be represented as <CmtsHostName></CmtsHostName > or < CmtsHostName />. An example FQDN is "cmts01.mso.com."

References: [RFC 2821].

#### C.3.2 CmtsSysUpTime<sup>231</sup>

CmtsSysUpTime is the sysUpTime value taken from the CMTS at the time the IPDR record is created, formatted in decimal notation and represented in XDR compact representation as a 32-bit integer. This is the number of 100ths of a second since initialization of the CMTS system or CMTS interface module, whichever is most appropriate for a given CMTS architecture. For any given Service Flow reported in an IPDRDoc, it is required that the value be monotonically increased to minimize SFIDs and SIDs reusage within a two reporting intervals, unless the system or interface represented by the sysUpTime value has been reinitialized. If the value has decreased, this can be used by the Collector as a hint that the service flow counters are likely to have regressed. It is specifically not required that the value of CmtsSysUpTime be the same for all records in an IPDRDoc.

References: [RFC 3418].

#### C.3.3 CmtsIpv4Addr

CmtsIpv4Addr is the IPv4 address for the CMTS. This element is formatted in standard decimal dotted notation such as 10.10.100.1. The XDR compact representation of this element is a 32-bit integer.

#### C.3.4 CmtsIpv6Addr

CmtsIpv6Addr is the IPv6 address for the CMTS. This element is formatted in colon separated 2-byte block hexadecimal notation such as FEDC:AB19:12FE:0234:98EF:1178:8891:CAFF. The XDR compact representation of this element is a 32-bit integer.

<sup>231</sup> Modified per CCAP-OSSiv3.1-N-16.1618-3 on 11/17/16 by KB.

### C.3.5 CmtsMdlfName

CmtsMdlfName contains the first 50 characters of the ifName from the Interfaces Group MIB for the row entry corresponding to the CMTS MAC Domain interface (ifType = 127) for this CM. The ifName is defined as: "The textual name of the interface. The value of this object should be the name of the interface as assigned by the local device and should be suitable for use in commands entered at the device's 'console'. This might be a text name, such as 'le0' or a simple port number, such as '1', depending on the interface naming syntax of the device. If several entries in the ifTable together represent a single interface as named by the device, then each will have the same value of ifName. Note that for an agent which responds to SNMP queries concerning an interface on some other (proxied) device, then the value of ifName for such an interface is the proxied device's local name for it. If there is no local name, or this attribute is otherwise not applicable, then this attribute contains a zero-length string.

References: [RFC 2863].

### C.3.6 CmtsMdlfIndex

CmtsMdlfIndex is the ifIndex from the Interfaces Group MIB for the CMTS MAC Domain interface (described in CmtsMdlfName). This value makes the ServiceIdentifier unique.

References: [RFC 2863].

## C.4 CM Information Schema

Refer to Section 2.1 Normative References for this service definition XML schema.

## C.5 Record Information<sup>232</sup>

The DOCSIS Record Information auxiliary schema contains the following attributes which define information about an IPDR record. Refer to Section 2.1 Normative References for this service definition XML schema.

**Table C-2 - Record Information Attributes**

Category	Attribute Name	Type	Presence	Permitted Values
What	RecType	Integer	Required	Interim(1) Stop(2) Start(3) Event(4)
When	RecCreationTime	dateTimeMsec	Required	yyyy-mm-ddThh:mm:ss.mmmZ

### C.5.1 RecType

The service flow type may be either Interim or Stop. An Interim type indicates a running service flow. A Stop type indicates a terminated service flow. A terminated service flow is only reported once in the IPDRDoc that is created on the cycle after the service flow is deleted. An Interim service flow is reported in each IPDRDoc that is created while it is running.

The CMTS MUST include in the IPDR record the current sample of the active counters for a running service flow.

The CMTS MUST include in the IPDR record the final, logged counter values for a terminated service flow.

### C.5.2 RecCreationTime

The RecCreationTime = "yyyy-mm-ddThh:mm:ssZ" UTC time stamp at the time the data for the record was acquired based on CmtsSysUpTime (see CMTS Information section) value. The compact representation of this attribute is the 64-bit Long value since Epoch Time.

The CMTS MUST NOT delete the internal logged SF counters until after the terminated service flow has been recorded into an IPDR record that has been transmitted to a collector and acknowledged or stored in non-volatile memory, regardless of any other capability to manage them via SNMP through the DOCS-QOS3-MIB.

The time zone is always GMT for DOCSIS IPDRs.

<sup>232</sup> Modified per CCAP-OSSlv3.1-N-16.1618-3 on 11/17/16 by KB.

## C.6 QoS Information<sup>233</sup>

The DOCSIS QoS Information auxiliary schema contains the following attributes which define QoS information such as service flow information and counters. Refer to Section 2.1 Normative References for this service definition XML schema.

**Table C-3 - QoS Information Attributes**

Category	Attribute Name	Type	Presence	Permitted Values
Where	ServiceFlowChSet	hexBinary	Required	SIZE (1..255)
What	ServiceAppId	unsignedInt	Required	32-bit integer
What	ServiceDsMulticast	boolean	Required	true, false
What	ServiceIdentifier	unsignedInt	Required	32-bit integer
What	ServiceGateId	unsignedInt	Required	32-bit integer
What	ServiceClassName	String	Required	ASCII string identifier
What	ServiceDirection	Integer	Required	Downstream(1) Upstream(2)
What	ServiceOctetsPassed	unsignedLong	Required	64-bit counter, in decimal notation
What	ServicePktsPassed	unsignedLong	Required	64-bit counter, in decimal notation
What	ServiceSlaDropPkts	unsignedInt	Required	32-bit counter, in decimal notation
What	ServiceSlaDelayPkts	unsignedInt	Required	32-bit integer, in decimal notation
When	ServiceTimeCreated	unsignedInt	Required	32-bit integer
When	ServiceTimeActive	unsignedInt	Required	32-bit integer

### C.6.1 ServiceFlowChSet

The ServiceFlowChSet attribute contains the set of channels configured for the service flow. Each octet represents the channel id of a channel.

### C.6.2 ServiceAppId

The ServiceAppId attribute contains the application identifier associated with the service flow.

### C.6.3 ServiceDsMulticast

The ServiceDsMulticast attribute indicates whether the service flow is multicast or unicast. A value of 'true' indicates a multicast service flow. A value of 'false' indicates a unicast service flow.

### C.6.4 ServiceIdentifier

The ServiceIdentifier attribute contains the internal service flow identifier (SFID) for DOCSIS 1.1 QoS provisioned CMs known to the CMTS. This attribute is needed to correlate the IPDRs for an individual service flows between adjacent IPDR records when computing delta counters. To avoid potential confusion in the billing system, it is desirable that the CMTS not reuse the ServiceIdentifier component for a minimum of two collection cycles. Depending of the collection interval and services dynamics, this goal may not be practical. As an intermediate solution, a CMTS MAY assign ServiceIdentifier (SFIDs/SIDs) values with a monotonically increasing pattern.

### C.6.5 ServiceGateId

The "GateID" associated with the service flow (SFID). For non-Dynamic service flows, a zero value is reported.

References: [PKT-DQOS]; [PCMM]; [MULPIv3.1].

### C.6.6 ServiceClassName

The ServiceClassName attribute contains the name associated with the QoS parameter set for this service flow in the CMTS. The SCN is an ASCII string identifier, such as "GoldUp" or "SilverDn", which can be used by external operations systems to assign, monitor, and bill for different levels of bandwidth service without having to interpret the details of the QoS parameter set itself. A service flow is associated with an SCN whenever a cable modem configuration file uses the SCN to define an active service flow. A dynamic service flow application such as

<sup>233</sup> Modified per CCAP-OSSiv3.1-N-16.1618-3 on 11/17/16 by KB.

PacketCable may also assign an SCN to a service flow as a parameter during the dynamic creation of the service flow. Note that the use of SCNs is optional within the context of the DOCSIS 3.1 MAC and Upper Layer Protocols Interface Specification, however, for operational purposes, especially when billing for tiered data services per this specification, their use often becomes mandatory. Since this policy is within the control of the operator, the use of SCNs is not mandatory in this specification, but rather highly recommended.

The CMTS MUST include the ServiceClassName attribute in the IPDR record. The CMTS MUST encode this attribute as a zero length string if no SCN is used to identify the service flow.

References: [PKT-DQOS]; [MULPIv3.1].

### **C.6.7 ServiceDirection**

The CMTS MUST include the ServiceDirection attribute, which identifies the service flow direction relative to the CMTS RFI interface, as follows:

- Identifies DOCSIS 1.1 downstream service flows passing packets from the CMTS to the CM.
- Identifies upstream DOCSIS 1.1 service flows passing packets from the cable modem to the CMTS.

### **C.6.8 ServiceOctetsPassed**

The CMTS MUST include the ServiceOctetsPassed attribute as follows:

- For DOCSIS QoS service flows, ServiceOctetsPassed contains the current (or final) 64-bit count of the number of octets passed, formatted in decimal notation.

If the RecType is Interim, then this is the current value of the running counter. If the RecType is Stop, then this is the final value of the terminated counter. The 64-bit counter value will not wrap around within the service lifetime of the CMTS.

### **C.6.9 ServicePktsPassed**

The CMTS MUST include the ServicePktsPassed attribute as follows:

- For DOCSIS QoS service flows, ServicePktsPassed contains the current (or final) 64-bit count of the number of packets passed, formatted in decimal notation.

If the RecType is Interim, then this is the current value of the running counter. If the RecType is Stop, then this is the final value of the terminated counter. The 64-bit counter value will not wrap around within the service lifetime of the CMTS.

### **C.6.10 ServiceSlaDropPkts**

The CMTS MUST include the ServiceSlaDropPkts attribute as follows:

- For DOCSIS QoS service flows, ServiceSlaDropPkts contains the current (or final) count of packets dropped by this service flow.

This is based on a 32-bit counter value maintained in the CMTS where it is unlikely to overflow within the service lifetime of the DOCSIS QoS service. Note that this value is the count of packets dropped by the CMTS for upstream service flows. Upstream packets dropped by the CM are not counted here.

### **C.6.11 ServiceSlaDelayPkts**

The CMTS MUST include the ServiceSlaDelayPkts attribute as follows:

- For DOCSIS QoS service flows, ServiceSlaDelayPkts contains the current (or final) count of packets delayed by this service flow.

This is based on a 32-bit counter value maintained in the CMTS where it is unlikely to overflow within the service lifetime of the DOCSIS QoS service. This counter value will not overflow within the service lifetime of the CMTS. Note that this value is the count of packets delayed by the CMTS for upstream service flows. Upstream packets delayed by the CM are not counted here.

### C.6.12 ServiceTimeCreated

The CMTS MUST include the ServiceTimeCreated attribute which contains the value of CmtsSysUpTime or CMTS interface module, whichever is most appropriate for a given CMTS architecture when service flow was created. For a given service flow instance, this value is required to be the same in every IPDRDoc file until the service flow is deleted and no longer being reported. If the value is not consistent between IPDRDoc files, this needs to be interpreted by the Collector as a completely new service flow instance.

### C.6.13 ServiceTimeActive

The CMTS MUST include the ServiceTimeActive attribute as follows:

- For DOCSIS QoS service flows, ServiceTimeActive contains the total time that the service flow is active in seconds.

If RecType is 'Stop(2)', the CMTS MUST report the total number of active seconds when the service flow was deleted.

## C.7 CPE Information

The DOCSIS CPE Information auxiliary schema contains the following attributes that uniquely identify a CPE. Refer to Section 2.1 Normative References for this service definition XML schema.

**Table C-4 - CPE Information Attributes**

Category	Attribute Name	Type	Presence	Permitted Values
Who	CpeMacAddr	macAddress	Required	nn.nn.nn.nn.nn
Who	Cpelpv4AddrList	hexBinary	Required	nnn.nnn.nnn.xxx nnn.nnn.nnn.yyy
Who	Cpelpv6AddrList	hexBinary	Required	xxxx:xxxx:xxxx:xxxx:xxxx:xxxx:xxxx:yyyy xxxx:xxxx:xxxx:xxxx:xxxx:xxxx:xxxx:zzzz
Who	CpeFqdn	String	Required	FQDN

### C.7.1 CpeMacAddr

The Ethernet MAC address of each CPE using this CM during the reporting interval. The CMTS normally tracks CPE MAC addresses per CM, but there may be cases where they are not reported in this element, in which case the value of this element is encoded as macAddress type with value of all zeros.

### C.7.2 Cpelpv4AddrList

List of IPv4 address assigned to each CPE using this CM during the reporting interval. If the CMTS is not tracking CPE IP addresses, then the value of this element is encoded as zero length list. This element may be non-null only for the default upstream SID/service flow for a CM, and gives the current known CPE IP addresses on the CM's Ethernet interface regardless of the SID/SF from which the CPE IP address was learned. All CPE IP addresses maintained in an ARP table for a cable MAC interface need to be reported in this field of at least one IPDR record. It is not expected that CpeIpv4AddrList values reported are unique to a single CM, since the CMTS may implement multiple overlapping private IP address spaces.

The XDR encoding type is hexBinary consisting of consecutive 32-bit unsigned integers each one being an ipV4Addr data type. Thus, the encoding of multiple CPE IP Addresses in the Cpelpv4AddrList corresponds to a multiple of 4-octet string.

**NOTE:** The configuration state of the DOCS-SUBMGT3-MIB influences whether CPE IP addresses are being tracked by the CMTS and are thus being reported in the IPDRs (the DOCS-SUBMGT3-MIB controls the CM and CPE filters on the CMTS). Other mechanisms such as the ARP table may also be used in this case.

### C.7.3 Cpelpv6AddrList

List of IPv6 address assigned to each CPE using this CM during the reporting interval. If the CMTS is not tracking CPE IP addresses, then the value of this element is encoded as zero length list. This element may be non-null only for the default upstream SID/service flow for a CM, and gives the current known CPE IP addresses on the CM's Ethernet interface regardless of the SID/SF from which the CPE IP address was learned. All CPE IP addresses

maintained in an ARP table for a cable MAC interface need to be reported in this field of at least one IPDR record. It is not expected that CpeIpv6AddrList values reported are unique to a single CM, since the CMTS may implement multiple overlapping private IP address spaces.

The XDR encoding type is hexBinary consisting of consecutive ipV6Addr data types (4 byte length + 16 byte address encoding). Thus, the encoding of multiple CPE IP Addresses in the CpeIpv6AddrList corresponds to a multiple of 20-octet string.

**C.7.4 CpeFqdn**

The Fully Qualified Domain Name (FQDN) assigned to each CPE using this CM during the reporting interval. If the CMTS is not tracking CPE FQDNs, then this element will be the zero-length string. This element includes only CPE FQDNs gleaned by the CMTS, such as from DHCP relay, and otherwise stored in the CMTS for reporting or other purposes. It is not required for the CMTS to query perform reverse DNS query to obtain the FQDN of a CPE IP address otherwise reported in the CpeIpv4AddrList or CpeIpv6AddrList field. An example FQDN is "Cpe1@cm1.cmts2.com."

References: [RFC 2821].

Refer to Section 2.1 Normative References for this service definition XML schema.

**C.8 Spectrum Measurement Information**

Refer to the CmtsSpectrumAnalysisMeas object of Section 6.7.1.2 for the definition of the Spectrum Measurement attributes.

Refer to Section 2.1 Normative References for this service definition XML schema.

**C.9 Diagnostic Log Information**

Refer to the DiagLog and DiagLogDetail objects of Annex A for the definition of the Diagnostic Log attributes.

Refer to Section 2.1 Normative References for this service definition XML schema.

**C.10 CMTS CM Upstream Status Information**

Refer to the CmtsCmUsStatus object of Section 7.2.2.2.2 for the definition of the CMTS CM Upstream Status attributes.

Refer to Section 2.1 Normative References for this service definition XML schema.

**C.11 CMTS CM Node Channel Information**

Refer to the CmtsCmRegStatus object in Section 7 for the definition of the CMTS CM Node Channel attributes.

**C.12 CMTS MAC Domain Node Information**

Refer to the MdNodeStatus, MdDsSgStatus and MdUsSgStatus objects in Section 7 for the definition of the MAC Domain (MD) Node attributes.

Refer to Section 2.1 Normative References for this service definition XML schema.

**C.13 CMTS Upstream Utilization Information**

Refer to Section 2.1 Normative References for this service definition XML schema.

The DOCSIS CMTS Upstream Utilization Information auxiliary schema contains the following attributes which define upstream logical channel utilization counters.

**Table C-5 - CMTS Upstream Utilization Information Attributes**

Category	Attribute Name	Type	Presence	Permitted Values
Which	lfIndex	unsignedInt	Required	nnnnnnnn

Category	Attribute Name	Type	Presence	Permitted Values
What	IfName	String	Required	SIZE(0..50)
What	UsChId	unsignedByte	Required	1..255
What	Interval	unsignedInt	Required	0..86400
What	IndexPercentage	unsignedByte	Required	0..100
What	TotalMslots	unsignedLong	Required	64-bit counter, in decimal notation
What	UcastGrantedMslots	unsignedLong	Required	64-bit counter, in decimal notation
What	TotalCntnMslots	unsignedLong	Required	64-bit counter, in decimal notation
What	UsedCntnMslots	unsignedLong	Required	64-bit counter, in decimal notation
What	CollCntnMslots	unsignedLong	Required	64-bit counter, in decimal notation
What	TotalCntnReqMslots	unsignedLong	Required	64-bit counter, in decimal notation
What	UsedCntnReqMslots	unsignedLong	Required	64-bit counter, in decimal notation
What	CollCntnReqMslots	unsignedLong	Required	64-bit counter, in decimal notation
What	TotalCntnReqDataMslots	unsignedLong	Required	64-bit counter, in decimal notation
What	UsedCntnReqDataMslots	unsignedLong	Required	64-bit counter, in decimal notation
What	CollCntnReqDataMslots	unsignedLong	Required	64-bit counter, in decimal notation
What	TotalCntnInitMaintMslots	unsignedLong	Required	64-bit counter, in decimal notation
What	UsedCntnInitMaintMslots	unsignedLong	Required	64-bit counter, in decimal notation
What	CollCntnInitMaintMslots	unsignedLong	Required	64-bit counter, in decimal notation

### C.13.1 IfIndex

The ifIndex from the Interfaces Group MIB for the CMTS upstream logical channel interface.

### C.13.2 ifName

The ifName from the Interfaces Group MIB for the CMTS upstream interface.

### C.13.3 UsChId

This attribute represents the upstream channel id.

### C.13.4 Interval

This attribute represents the time interval, in seconds, over which the channel utilization index is calculated.

References: [RFC 4546] docsIfCmtsChannelUtilizationInterval.

### C.13.5 IndexPercentage<sup>234</sup>

For SC-QAM channels, this attribute represents the calculated and truncated utilization index percentage for the upstream logical channel interface.

For OFDMA channels, this is the OfdmaChannelUtilization attribute as defined in Section 7.2.2.7.1.1.24.

References: [RFC 4546] docsIfCmtsChannelUtUtilization.

### C.13.6 TotalMslots

This attribute represents the current count, from CMTS initialization, of all minislots defined for this upstream logical channel interface. This count includes all IUCs and SIDs, even those allocated to the NULL SID for a logical channel that is inactive.

Reference: [RFC 4546] docsIfCmtsUpChnlCtrExtTotalMslots.

### C.13.7 UcastGrantedMslots

This attribute represents the current count, from CMTS initialization, of unicast granted minislots on the upstream logical channel regardless of burst type. Unicast granted minislots are those in which the CMTS assigned bandwidth to any unicast SID on the logical channel. However, this object does not include minislots for reserved IUCs, or grants to SIDs designated as meaning 'no CM'.

<sup>234</sup> Modified per CCAP-OSSiv3.1-N-15.1390-2 on 11/11/15 by KB.

References: [RFC 4546] docsIfCmtsUpChnlCtrExtUcastGrantedMslots.

### **C.13.8 TotalCntnMslots**

This attribute represents the current count, from CMTS initialization, of contention minislots defined for this upstream logical channel. This count includes all minislots assigned to a broadcast or multicast SID on the logical channel.

References: [RFC 4546] docsIfCmtsUpChnlCtrExtTotalCntnMslots.

### **C.13.9 UsedCntnMslots**

This attribute represents the current count, from CMTS initialization, of contention minislots utilized on the upstream logical channel. For contention regions, utilized minislots are those in which the CMTS correctly received an upstream burst from any CM on the upstream logical channel.

References: [RFC 4546] docsIfCmtsUpChnlCtrExtUsedCntnMslots.

### **C.13.10 CollCntnMslots**

This attribute represents the current count, from CMTS initialization, of collision contention minislots on the upstream logical channel. For contention regions, these are the minislots applicable to burst that the CMTS detected but could not correctly receive.

References: [RFC 4546] docsIfCmtsUpChnlCtrExtCollCntnMslots.

### **C.13.11 TotalCntnReqMslots**

This attribute represents the current count, from CMTS initialization, of contention request minislots defined for this upstream logical channel. This count includes all minislots for IUC1 assigned to a broadcast or multicast SID on the logical channel.

References: [RFC 4546] docsIfCmtsUpChnlCtrExtTotalCntnReqMslots.

### **C.13.12 UsedCntnReqMslots**

This attribute represents the current count, from CMTS initialization, of contention request minislots utilized on this upstream logical channel. This count includes all contention minislots for UIC1 applicable to bursts that the CMTS correctly received.

References: [RFC 4546] docsIfCmtsUpChnlCtrExtUsedCntnReqMslots.

### **C.13.13 CollCntnReqMslots**

This attribute represents the current count, from CMTS initialization, of contention request minislots subjected to collisions on this upstream logical channel. This includes all contention minislots for IUC1 applicable to bursts that the CMTS detected but could not correctly receive.

References: [RFC 4546] docsIfCmtsUpChnlCtrExtCollCntnReqMslots.

### **C.13.14 TotalCntnReqDataMslots**

This attribute represents the current count, from CMTS initialization, of contention request data minislots defined for this upstream logical channel. This count includes all minislots for IUC2 assigned to a broadcast or multicast SID on the logical channel.

References: [RFC 4546] docsIfCmtsUpChnlCtrExtTotalCntnReqMslots.

### **C.13.15 UsedCntnReqDataMslots**

This attribute represents the current count, from CMTS initialization, of contention request data minislots utilized on this upstream logical channel. This includes all contention minislots for IUC2 applicable to bursts that the CMTS correctly received.

References: [RFC 4546] docsIfCmtsUpChnlCtrExtUsedCntnReqMslots.



**C.13.16 CollCntnReqDataMslots**

This attribute represents the current count, from CMTS initialization, of contention request data minislots subjected to collisions on this upstream logical channel. This includes all contention minislots for IUC2 applicable bursts that the CMTS detected but could not correctly receive.

References: [RFC 4546] docsIfCmtsUpChnlCtrExtCollCntnReqMslots.

**C.13.17 TotalCntnInitMaintMslots**

This attribute represents the current count, from CMTS initialization, of initial maintenance minislots defined for this upstream logical channel. This count includes all minislots for IUC3 assigned to a broadcast or multicast SID on the logical channel.

References: [RFC 4546] docsIfCmtsUpChnlCtrExtTotalCntnInitMaintMslots.

**C.13.18 UsedCntnInitMaintMslots**

This attribute represents the current count, from CMTS initialization, of initial maintenance minislots utilized on this upstream logical channel. This includes all contention minislots for IUC3 applicable to bursts that the CMTS correctly received.

References: [RFC 4546] docsIfCmtsUpChnlCtrExtUsedCntnInitMaintMslots.

**C.13.19 CollCntnInitMaintMslots**

This attribute represents the current count, from CMTS initialization, of contention initial maintenance minislots subjected to collisions on this upstream logical channel. This includes all contention minislots for IUC3 applicable to bursts that the CMTS detected but could not correctly receive.

References: [RFC 4546] docsIfCmtsUpChnlCtrExtCollCntnInitMaintMslots.

**C.14 CMTS Downstream Utilization Information**

Refer to Section 2.1 Normative References for this service definition XML schema.

The DOCSIS CMTS Downstream Utilization Information auxiliary schema contains the following attributes which define downstream utilization counters.

**Table C-6 - CMTS Downstream Utilization Information Attributes**

Category	Attribute Name	Type	Presence	Permitted Values
Which	IfIndex	unsignedInt	Required	nnnnnnnnn
What	DsChId	unsignedByte	Required	1..255
What	IfName	String	Required	SIZE(0..50)
What	Interval	unsignedInt	Required	0..86400
What	IndexPercentage	unsignedByte	Required	0..100
What	TotalBytes	unsignedLong	Required	64-bit counter, in decimal notation
What	UsedBytes	unsignedLong	Required	64-bit counter, in decimal notation

**C.14.1 IfIndex**

The ifIndex from the Interfaces Group MIB for the CMTS downstream interface.

**C.14.2 IfName**

The ifName from the Interfaces Group MIB for the CMTS downstream interface.

**C.14.3 DsChId**

This attribute represents the downstream channel id.

**C.14.4 Interval**

This attribute represents the time interval, in seconds, over which the channel utilization index is calculated.

References: [RFC 4546] docsIfCmtsChannelUtilizationInterval.

**C.14.5 IndexPercentage<sup>235</sup>**

For SC-QAM channels, this attribute represents the calculated and truncated utilization index percentage for the downstream interface.

For OFDM channels, this is the OfdmChannelUtilization attribute as defined in Section 7.2.2.8.1.22.

References: [RFC 4546] docsIfCmtsChannelUtUtilization.

**C.14.6 TotalBytes<sup>236</sup>**

For SC-QAM channels, this attribute represents the total number of bytes in the payload portion of MPEG Packets, not including MPEG header or pointer\_field, transported by the downstream interface.

For OFDM channels, this is the largest ProfileFullChanSpeed assigned to this channel \* the DsUtilInterval \*8. Refer to Section 7.2.2.8.4.3.

Reference: [RFC 4546] docsIfCmtsDownChnlCtrExtTotalBytes.

**C.14.7 UsedBytes<sup>237</sup>**

For SC-QAM channels, this attribute represents the total number of DOCSIS data bytes transported by the downstream interface. The number of data bytes is defined as the total number of bytes transported in DOCSIS payloads minus the number of stuff bytes transported in DOCSIS payloads.

For OFDM channels, this is DsUtilTotalBytes \* DsUtilIndexPercentage.

References: [RFC 4546] docsIfCmtsDownChnlCtrExtUsedBytes.

**C.15 Service Flow Information**

Refer to Section 2.1 Normative References for this service definition XML schema.

The DOCSIS Service Flow Information auxiliary schema contain the following attributes that describe the configured QoS parameters.

**Table C-7 - Service Flow Information Attributes<sup>238</sup>**

Category	Attribute Name	Type	Presence	Permitted Values
What	ServiceTrafficPriority	unsignedInt	Required	
What	ServiceMaxSustained	unsignedLong	Required	
What	ServiceMaxBurst	unsignedInt	Required	
What	ServiceMinReservedRate	unsignedLong	Required	
What	ServiceMinReservedPktSize	unsignedInt	Required	
What	ServiceIpTos	hexBinary	Required	
What	ServicePeakRate	unsignedLong	Required	
What	ServiceSchedule	Integer	Required	0 Reserved 1 for Undefined (CMTS implementation-dependent1) 2 for Best Effort 3 for Non-Real-Time Polling Service 4 for Real-Time Polling Service 5 for Unsolicited Grant Service with Activity Detection 6 for Unsolicited Grant Service
What	ServiceNomPollInterval	unsignedInt	Required	
What	ServiceToIPolJitter	unsignedInt	Required	

<sup>235</sup> Modified per CCAP-OSSlv3.1-N-15.1390-2 on 11/11/15 by KB.

<sup>236</sup> Modified per CCAP-OSSlv3.1-N-15.1390-2 on 11/11/15 by KB.

<sup>237</sup> Modified per CCAP-OSSlv3.1-N-15.1390-2 on 11/11/15 by KB.

<sup>238</sup> Modified per CCAP-OSSlv3.1-N-15.1390-2 on 11/11/15 by KB.

Category	Attribute Name	Type	Presence	Permitted Values
What	ServiceUGSize	unsignedInt	Required	
What	ServiceNomGrantInterval	unsignedInt	Required	
What	ServiceTolGrantJitter	unsignedInt	Required	
What	ServiceGrantsPerInterval	unsignedInt	Required	
What	ServicePacketClassifiers	hexBinary	Required	

### C.15.1 ServiceTrafficPriority

The value of the relative priority assigned to this service flow.

### C.15.2 ServiceMaxSustained

The value of the maximum rate in bits/second assigned to this service flow.

### C.15.3 ServiceMaxBurst

The value of the maximum rate in bits/second assigned to this service flow.

### C.15.4 ServiceMinReservedRate

The minimum reserved rate in bits/second assigned to this service flow.

References: Section 7, MinReservedRate attribute of ParamSet object.

### C.15.5 ServiceMinReservedPktSize

The value of the assumed minimum packet size in bytes for which the ServiceMinReservedRate will be provided.

References: Section 7, MinReservedPkt attribute of ParamSet object.

### C.15.6 ServiceIpTos

The value of the IP Type of Service (DSCP) Overwrite assigned to this service flow. This is encoded as hexBinary in 2 bytes. The first byte is encoding the tos-and-mask, the second byte is encoding the tos-or-mask.

References: Section 7, TosAndMask and TosOrMask attributes of ParamSet object.

### C.15.7 ServicePeakRate

The value of the Peak Traffic Rate in bit/second assigned to this service flow.

### C.15.8 ServiceSchedule

The value for the scheduling type assigned to this service flow.

### C.15.9 ServiceNomPollInterval

The value of the Nominal Polling Interval in microseconds assigned to this service flow.

### C.15.10 ServiceToIPollJitter

The value of Tolerated Poll Jitter in microseconds assigned to this service flow.

### C.15.11 ServiceUGSize

The value of the Unsolicited Grant Size in bytes assigned to this service flow.

### C.15.12 ServiceNomGrantInterval

The value of the Nominal Grant Interval in microseconds assigned to this service flow.

### C.15.13 ServiceToIGrantJitter

The value of the Tolerated Grant Jitter in microseconds assigned to this service flow.

### C.15.14 ServiceGrantsPerInterval

The value of the Grants Per Interval as integer (0-127) assigned to this service flow.

### C.15.15 ServicePacketClassifiers

Packet classifiers assigned to this service flow. Each classifier is encoded in hexBinary according to the TLV encoding. When multiple classifiers exist for the same service flow then they are encoded as the concatenated sequence of encodings of each classifier.

References: [MULPIv3.1] Quality-of-Service-Related Encodings annex

Refer to Section 2.1 Normative References for this service definition XML schema.

## C.16 IP Multicast Information<sup>239</sup>

For the full text of this schema, refer to [DOCSIS-IP-MULTICAST].

The DOCSIS IP Multicast Information auxiliary schema contains the following attributes that describe the joined (S,G) IP multicast session parameters.

**Table C-8 - IP Multicast Information Attributes**

Category	Attribute Name	Type	Presence	Permitted Values
What	IpMcastSrcIpv4Addr	InetAddressIPv4	Required	
What	IpMcastSrcIpv6Addr	InetAddressIPv6	Required	
What	IpMcastGrpIpv4Addr	InetAddressIPv4	Required	
What	IpMcastGrpIpv6Addr	InetAddressIPv6	Required	
What	IpMcastGsflid	unsignedInt	Required	
What	IpMcastDsid	unsignedInt	Required	
What	IpMcastSessionProtocolType	Integer	Required	0 Reserved 1 for IGMP 2 for MLD
What	IpMcastCpeMacAddrList	hexBinary	Required	
When	IpMcastJoinTime	dateTimeMsec	Required	yyyy-mm-ddThh:mm:ss:mmmZ
When	IpMcastLeaveTime	dateTimeMsec	Required	yyyy-mm-ddThh:mm:ss:mmmZ

### C.16.1 IpMcastSrcIpv4Addr

The value of the IPv4 address of 'S' as the source address for a particular (S,G) IP multicast session. For the case of Any Source Multicast (ASM), this attribute reports a value of 0.0.0.0.

### C.16.2 IpMcastSrcIpv6Addr

The value of the IPv6 address of 'S' as the source address for a particular (S,G) IP multicast session. For the case of Any Source Multicast (ASM), this attribute reports a value of 0::/0.

### C.16.3 IpMcastGrpIpv4Addr

The value of the IPv4 address of 'G' as the group address for a particular (S,G) IP multicast session.

### C.16.4 IpMcastGrpIpv6Addr

The value of the IPv6 address of 'G' as the group address for a particular (S,G) IP multicast session.

### C.16.5 IpMcastGsflid

The value of the Group Service Flow Id. This element is associated with the ServiceIdentifier element from the SAMIS-TYPE-1 and SAMIS-TYPE-2 Service Definition Schemas.

### C.16.6 IpMcastDsid

The value of the Downstream Service ID (DSID) label with which the CMTS labels all packets of a particular (S,G) IP multicast session.

<sup>239</sup> Added per CCAP-OSSv3.1-15.1390-2 on 11/11/15 by KB.

### **C.16.7 IpMcastSessionProtocolType**

The value of the type of IP multicast session (Reserved, IGMP or MLD).

### **C.16.8 IpMcastCpeMacAddrList**

The value of the list of CPE MAC addresses joining the (S,G) IP multicast session. The associated CPE IPv4 and IPv6 address information can be obtained with the CPE-TYPE Service Definition Schema.

### **C.16.9 IpMcastJoinTime**

The value of the UTC time stamp "yyyy-mm-ddThh:mm:ssZ" at the time the IP multicast JOIN request from this CPE for this multicast session was processed by the CMTS. The compact representation of this attribute is the 64-bit Long value of milliseconds since Epoch Time.

### **C.16.10 IpMcastLeaveTime**

The value of the UTC time stamp "yyyy-mm-ddThh:mm:ssZ" at the time the "LeaveMulticastSession" request from this CPE for this multicast session was processed by the CMTS or the CMTS determines that this CPE has left the IP multicast session. The compact representation of this attribute is the 64-bit Long value of milliseconds since Epoch Time.

If the multicast session is active (i.e., the CMTS has yet to determine that the CPE has left the IP multicast session) when this record is generated, the compact representation of the IpMcastLeaveTime value MUST be set to 0.

Reference: [MULPIv3.0] Downstream Multicast Forwarding section.

## **C.17 CMTS CM Downstream OFDM Information**

Refer to the CmtsCmRegStatus object of Section 7.2.2.2.1 for the definition of the attributes found in the CMTS CM Downstream OFDM Information Schema.

Refer to Section 2.1 Normative References for this service definition XML schema.

## **C.18 CMTS CM Partial Channel/Service Information**

Refer to the attributes related to Partial Channel and Partial Service conditions in the CmtsCmRegStatus, CmtsCmDsOfdmStatus, CmtsCmDsOfdmProfileStatus, CmtsCmUsOfdmaStatus and CmtsCmUsOfdmaProfile objects of Section 7.2.2 for the definition of the attributes found in the CMTS CM Partial Channel/Service Information Schema.

Refer to Section 2.1 Normative References for this service definition XML schema.

## **C.19 CMTS CM Upstream OFDMA Information**

Refer to the CmtsCmUsOfdmaStatus object of Section 7.2.2.2.3 for the definition of the attributes found in the CMTS CM Upstream OFDMA Information Schema.

Refer to Section 2.1 Normative References for this service definition XML schema.

## **C.20 OFDM Profile Status Information**

Refer to the CmtsCmRegStatus, CmtsCmDsOfdmProfileStatus and CmtsCmUsOfdmaProfile objects of Section 7.2.2 as well as the UsOfdmaChannelDataIucStats object of Section 7.2.2.7.3 and the DsOfdmProfileStats object of Section 7.2.2.8.4 for the definition of the OFDM Profile Status attributes. Note: in this case the term "OFDM Profile" is used generically to apply to either a downstream OFDM profile or an upstream OFDMA profile/data IUC.

Refer to Section 2.1 Normative References for this service definition XML schema.

## Annex D Format and Content for Event, SYSLOG, and SNMP Notification (Normative)

Table D-1 in this annex summarizes the format and content for event, syslog, and SNMP notifications required for DOCSIS 3.1-compliant CMTS and CCAP.

Each row specifies a possible event that may appear in the CMTS and CCAP. These events are to be reported by a cable device through local event logging, and may be accompanied by syslog or SNMP notification.

The "Process" and "Sub-Process" columns indicate in which stage the event happens. The "CMTS/CCAP Priority" column indicates the priority the event is assigned in the CMTS and CCAP. These priorities are the same as is reported in the docsDevEvLevel object in the cable device MIB [RFC 4639] and in the LEVEL field of the syslog.

The "Event Message" column specifies the event text, which is reported in the docsDevEvText object of the cable device MIB and the text field of the syslog. The "Message Notes And Details" column provides additional information about the event text in the "Event Message" column. Some of the text fields include variable information. The variables are explained in the "Message Notes And Details" column. For some events the "Message Notes And Details" column may include the keyword <Deprecated> to indicate this event is being deprecated and its implementation is optional. For events where the "Event Message" or "Message Notes and Details" column includes either <P1> or <P2>, there is a single space between the value as defined by the <P1> or <P2> and the preceding text.

Example SNMP Notification and Syslog message "Event Message" text string for Event ID 69020900:

```
SNMP CVC Validation Failure SNMP Manager: 10.50.1.11;CM-MAC=00:22:ce:03:f4:da;CMTS-
MAC=00:15:20:00:25:ab;CM-QOS=1.1;CM-VER=3.0;
```

This specification defines the following keywords as part of the "Event Message" column:

"<TAGS>" (without the quotes) corresponds to:

For the CMTS (without the quotes): ";<CM-MAC>;<CM-QOS>;<CM-VER>;<CMTS-VER>";

Where:

<CM-MAC>: CM MAC Address;

Format\*: "CM-MAC=xx:xx:xx:xx:xx:xx"

<CMTS-MAC>: CMTS MAC Address;

Format\*: "CMTS-MAC=xx:xx:xx:xx:xx:xx"

<CM-QOS>: CM DOCSIS QOS Version;

Format\*: "CM-QOS=1.0" or "CM-QOS=1.1"

<CM-VER>: CM DOCSIS Version;

Format\*: "CM-VER=1.1" or "CM-VER=2.0" or "CM-VER=3.0" or "CM-VER=3.1"

<CMTS-VER>: CMTS DOCSIS Version;

Format\*: "CMTS-VER=1.1" or "CMTS-VER=2.0" or "CMTS-VER=3.0" or "CMTS-VER=3.1"

(\* without the quotes)

The CCAP MUST support all mandatory events as defined in Table D-1, as well as the list of events defined in Table D-2. The CMTS MUST support all mandatory events defined in Table D-1.

Example SNMP Notification and Syslog message "Event Message" text string for Event ID 69010100:

```
SW Download INIT - Via NMS SW file: junk.bin - SW server: 10.50.1.11;CM-
MAC=00:22:ce:03:f4:da;CMTS-MAC=00:15:20:00:25:ab;CM-QOS=1.1;CM-VER=3.0;
```

The CMTS and CCAP MAY append additional vendor-specific text to the end of the event text reported in the docsDevEvText object and the syslog text field.

The "Error Code Set" column specifies the error code. The "Event ID" column indicates a unique identification number for the event, which is assigned to the docsDevEvId object in the cable device MIB and the <eventId> field of the syslog. The "Notification Name" column specifies the SNMP notification, which notifies this event to an SNMP notification receiver.

The syslog format, as well as the rules to uniquely generate an event ID from the error code, are described in Section 9.2.2.1.3 of this specification.

**Table D-1 - Event Format and Content<sup>240</sup>**

Process	Sub-Process	CMTS/ CCAP Priority	Event Message	Message Notes and Detail	Error Code Set	Event ID	Notification Name
<b>Authentication and Encryption</b>							
			<Reserved>			0	
BPKM	AUTH-FSM	Error	Auth Reject - No Information<TAGS>		B301.2	66030102	CMTS: docsIf3CmtsEventNotif
BPKM	AUTH-FSM	Error	Auth Reject - Unauthorized CM<TAGS>		B301.3	66030103	CMTS: docsIf3CmtsEventNotif
BPKM	AUTH-FSM	Error	Auth Reject - Unauthorized SAID<TAGS>		B301.4	66030104	CMTS: docsIf3CmtsEventNotif
BPKM	AUTH-FSM	Error	Auth Reject - Permanent Authorization Failure<TAGS>		B301.8	66030108	CMTS: docsIf3CmtsEventNotif
BPKM	AUTH-FSM	Error	Auth Reject - Time of Day not acquired<TAGS>		B301.9	66030109	CMTS: docsIf3CmtsEventNotif
BPKM	AUTH-FSM	Informational	Auth Reject - EAE disabled<TAGS>		B301.10	66030110	CMTS: docsIf3CmtsEventNotif
BPKM	AUTH-FSM	Error	CM Certificate Error<TAGS>		B301.11	66030111	CMTS: docsIf3CmtsEventNotif
BPKM	AUTH-FSM	Error	Auth Invalid - No Information<TAGS>		B302.2	66030202	CMTS: docsIf3CmtsEventNotif
BPKM	AUTH-FSM	Error	Auth Invalid - Unauthorized CM<TAGS>		B302.3	66030203	CMTS: docsIf3CmtsEventNotif
BPKM	AUTH-FSM	Error	Auth Invalid - Unsolicited<TAGS>		B302.5	66030205	CMTS: docsIf3CmtsEventNotif
BPKM	AUTH-FSM	Error	Auth Invalid - Invalid Key Sequence Number<TAGS>		B302.6	66030206	CMTS: docsIf3CmtsEventNotif
BPKM	AUTH-FSM	Error	Auth Invalid - Message (Key Request) Authentication Failure<TAGS>		B302.7	66030207	CMTS: docsIf3CmtsEventNotif
BPKM	AUTH-FSM	Error	Unsupported Crypto Suite<TAGS>		B303.0	66030300	CMTS: docsIf3CmtsEventNotif
BPKM	CERTIFICATE REVOCATION	Warning	Failed to retrieve CRL from <P1>	P1 = CRL Server IP	B304.0	66030400	CMTS: docsIf3CmtsEventNotif
BPKM	CERTIFICATE REVOCATION	Warning	Failed to retrieve OCSP status		B304.1	66030401	CMTS: docsIf3CmtsEventNotif

<sup>240</sup> Modified per CCAP-OSSv3.1-N-15.1307-3 on 6/1/15 by KB; per CCAP-OSSv3.1-N-16.1427-1 on 5/13/16 by KB; per CCAP-OSSv3.1-16.1533-2 and CCAP-OSSv3.1-N-16.1536-6 on 11/15/16 by KB; per CCAP-OSSv3.1-N-16.1572-1 on 11/16/16 by KB; per CCAP-OSSv3.1-N-16.1609-1 on 11/17/16 by KB.



Process	Sub-Process	CMTS/ CCAP Priority	Event Message	Message Notes and Detail	Error Code Set	Event ID	Notification Name
BPKM	CERTIFICATE REVOCATION	Warning	CRL data not available when validating CM certificate chain<TAGS>		B304.2	66030402	CMTS: docsIf3CmtsEventNotif
BPKM	TEK-FSM	Error	Key Reject - No Information<TAGS>		B501.2	66050102	CMTS: docsIf3CmtsEventNotif
BPKM	TEK-FSM	Error	Key Reject - Unauthorized SAID<TAGS>		B501.3	66050103	CMTS: docsIf3CmtsEventNotif
BPKM	TEK-FSM	Error	TEK Invalid - No Information<TAGS>		B502.3	66050203	CMTS: docsIf3CmtsEventNotif
BPKM	TEK-FSM	Error	TEK Invalid - Invalid Key Sequence Number<TAGS>		B502.6	66050206	CMTS: docsIf3CmtsEventNotif
Dynamic SA	SA MAP-FSM	Error	Unsupported Crypto Suite<TAGS>		B602.0	66060200	CMTS: docsIf3CmtsEventNotif
Dynamic SA	SA MAP-FSM	Informational	Map Reject - Downstream Traffic Flow Not Mapped to BPI+ SAID (EC=8)<TAGS>		B605.10	66060510	CMTS: docsIf3CmtsEventNotif
Dynamic SA	SA MAP-FSM	Error	Map Reject - Not Authorized for Requested Downstream Traffic Flow (EC=7)<TAGS>		B605.9	66060509	CMTS: docsIf3CmtsEventNotif
Dynamic SA	SA MAP-FSM	Error	Mapped to Existing SAID<TAGS>		B606.0	66060600	CMTS: docsIf3CmtsEventNotif
Dynamic SA	SA MAP-FSM	Error	Mapped to New SAID<TAGS>		B607.0	66060700	CMTS: docsIf3CmtsEventNotif
Init (BPI+)	DOCSIS 1.0 CONFIG FILE	Notice	Missing BP Configuration Setting TLV Type: <P1><TAGS>	P1 = missing required TLV Type	B101.0	66010100	CMTS: docsIf3CmtsEventNotif
Init (BPI+)	DOCSIS 1.0 CONFIG FILE	Notice	Invalid BP Configuration Setting Value: <P1> for Type: <P2><TAGS>	P1=The TLV Value for P2. P2 = The first Configuration TLV Type that contain invalid value.	B102.0	66010200	CMTS: docsIf3CmtsEventNotif
<b>DBC and DCC</b>							
DBC	DBC Response	Notice	Unknown DBC transaction<TAGS>		C601.0	67060100	
DBC	DBC Response	Warning	DBC-REQ rejected - confirmation code <P1>: <P2><TAGS>	P1=<Confirmation Code> P2=<Confirmation>	C602.0	67060200	
DBC	DBC Response	Warning	DBC-RSP not received<TAGS>		C603.0	67060300	

Process	Sub-Process	CMTS/ CCAP Priority	Event Message	Message Notes and Detail	Error Code Set	Event ID	Notification Name
DBC	DBC Response	Warning	Bad CM DBC-RSP: <P1><TAGS>	P1="unspecified reason"   "authentication failure"   "msg syntax error"	C604.0	67060400	
DBC	DBC Response	Warning	DBC-RSP Partial Service <P1><TAGS>	P1=<reason>	C605.0	67060500	
DCC	DCC Request	Warning	DCC rejected already there<TAGS>		C201.0	67020100	CMTS: docsIf3CmtsEventNotif
DCC	DCC Request	Notice	DCC depart old<TAGS>		C202.0	67020200	CMTS: docsIf3CmtsEventNotif
DCC	DCC Request	Notice	DCC arrive new<TAGS>		C203.0	67020300	CMTS: docsIf3CmtsEventNotif
DCC	DCC Request	Warning	DCC aborted unable to acquire new downstream channel<TAGS>		C204.0	67020400	
DCC	DCC Request	Warning	DCC aborted no UCD for new upstream channel<TAGS>		C205.0	67020500	
DCC	DCC Request	Warning	DCC aborted unable to communicate on new upstream channel<TAGS>		C206.0	67020600	
DCC	DCC Request	Warning	DCC rejected unspecified reason<TAGS>		C207.0	67020700	CMTS: docsIf3CmtsEventNotif
DCC	DCC Request	Warning	DCC rejected permanent - DCC not supported<TAGS>		C208.0	67020800	CMTS: docsIf3CmtsEventNotif
DCC	DCC Request	Warning	DCC rejected service flow not found<TAGS>		C209.0	67020900	CMTS: docsIf3CmtsEventNotif
DCC	DCC Request	Warning	DCC rejected required parameter not present<TAGS>		C210.0	67021000	CMTS: docsIf3CmtsEventNotif
DCC	DCC Request	Warning	DCC rejected authentication failure<TAGS>		C211.0	67021100	CMTS: docsIf3CmtsEventNotif
DCC	DCC Request	Warning	DCC rejected multiple errors<TAGS>		C212.0	67021200	CMTS: docsIf3CmtsEventNotif
DCC	DCC Request	Warning	DCC rejected, duplicate SF reference-ID or index in message<TAGS>		C215.0	67021500	CMTS: docsIf3CmtsEventNotif
DCC	DCC Request	Warning	DCC rejected parameter invalid for context<TAGS>		C216.0	67021600	CMTS: docsIf3CmtsEventNotif
DCC	DCC Request	Warning	DCC rejected message syntax error<TAGS>		C217.0	67021700	CMTS: docsIf3CmtsEventNotif

Process	Sub-Process	CMTS/ CCAP Priority	Event Message	Message Notes and Detail	Error Code Set	Event ID	Notification Name
DCC	DCC Request	Warning	DCC rejected message too big<TAGS>		C218.0	67021800	CMTS: docsIf3CmtsEventNotif
DCC	DCC Request	Warning	DCC rejected 2.0 mode disabled<TAGS>		C219.0	67021900	CMTS: docsIf3CmtsEventNotif
DCC	DCC Response	Warning	DCC-RSP not received on old channel<TAGS>		C301.0	67030100	CMTS: docsIf3CmtsEventNotif
DCC	DCC Response	Warning	DCC-RSP not received on new channel<TAGS>		C302.0	67030200	CMTS: docsIf3CmtsEventNotif
DCC	DCC Response	Warning	DCC-RSP rejected unspecified reason<TAGS>		C303.0	67030300	CMTS: docsIf3CmtsEventNotif
DCC	DCC Response	Warning	DCC-RSP rejected unknown transaction ID<TAGS>		C304.0	67030400	CMTS: docsIf3CmtsEventNotif
DCC	DCC Response	Warning	DCC-RSP rejected authentication failure<TAGS>		C305.0	67030500	CMTS: docsIf3CmtsEventNotif
DCC	DCC Response	Warning	DCC-RSP rejected message syntax error<TAGS>		C306.0	67030600	CMTS: docsIf3CmtsEventNotif
DCC	DCC Acknowledgement	Warning	DCC-ACK not received<TAGS>		C401.0	67040100	CMTS: docsIf3CmtsEventNotif
DCC	DCC Acknowledgement	Warning	DCC-ACK rejected unspecified reason<TAGS>		C402.0	67040200	CMTS: docsIf3CmtsEventNotif
DCC	DCC Acknowledgement	Warning	DCC-ACK rejected unknown transaction ID<TAGS>		C403.0	67040300	CMTS: docsIf3CmtsEventNotif
DCC	DCC Acknowledgement	Warning	DCC-ACK rejected authentication failure<TAGS>		C404.0	67040400	CMTS: docsIf3CmtsEventNotif
DCC	DCC Acknowledgement	Warning	DCC-ACK rejected message syntax error<TAGS>		C405.0	67040500	CMTS: docsIf3CmtsEventNotif
<b>Profile Change</b>							
DBC	DBC Request	Notice	Changed DS profile. MAC address: <P1>; DS Chan ID: <P2>; Previous Profile: <P3>; New Profile: <P4>. <TAGS>	P1: MAC Address of CM P2: Downstream channel ID P3: Previous OFDM Profile ID P4: New OFDM Profile ID	C606.0	67060600	CCAP: docsIf3CmtsEventNotif

Process	Sub-Process	CMTS/ CCAP Priority	Event Message	Message Notes and Detail	Error Code Set	Event ID	Notification Name
DBC	DBC Request	Notice	Changed US profile. MAC address: <P1>; US Chan ID: <P2>; Previous Profile: <P3>; New Profile: <P4>. <TAGS>	P1: MAC address of CM P2: Downstream channel ID P2: Previous OFDMA Profile ID P3: New OFDMA Profile ID	C606.1	67060601	CCAP: docsIf3CmtsEventNotif
<b>DHCP, TOD and TFTP</b>							
Init	IPv6 Address Acquisition	Warning	Link-Local address failed DAD<TAGS>		D001.1	68000101	
Init	IPv6 Address Acquisition	Warning	Link-Local address incorrectly formatted<TAGS>		D001.2	68000102	
<b>Secure Software Download</b>							
<b>Registration and TLV-11</b>							
Init	REGISTRATION REQUEST	Warning	Service unavailable - Other<TAGS>		I04.0	73000400	CMTS: docsIf3CmtsEventNotif
Init	REGISTRATION REQUEST	Warning	Service unavailable - Unrecognized configuration setting<TAGS>		I04.1	73000401	CMTS: docsIf3CmtsEventNotif
Init	REGISTRATION REQUEST	Warning	Service unavailable - Temporarily unavailable<TAGS>		I04.2	73000402	CMTS: docsIf3CmtsEventNotif
Init	REGISTRATION REQUEST	Warning	Service unavailable - Permanent<TAGS>		I04.3	73000403	CMTS: docsIf3CmtsEventNotif
Init	REGISTRATION REQUEST	Warning	Registration rejected authentication failure: CMTS MIC invalid<TAGS>		I05.0	73000500	CMTS: docsIf3CmtsEventNotif
Init	3.0 SPECIFIC REGISTRATION REQUEST	Warning	Registration authentication failure: REG REQ rejected -TLV parameters do not match learned config file TLV parameters<TAGS>		I05.1	73000501	CMTS: docsIf3CmtsEventNotif
Init	REGISTRATION REQUEST	Warning	REG REQ has Invalid MAC header<TAGS>		I101.0	73010100	CMTS: docsIf3CmtsEventNotif
Init	REGISTRATION REQUEST	Warning	REG REQ has Invalid SID or not in use<TAGS>		I102.0	73010200	CMTS: docsIf3CmtsEventNotif
Init	REGISTRATION REQUEST	Warning	REG REQ missed Required TLVs<TAGS>		I104.0	73010400	CMTS: docsIf3CmtsEventNotif

Process	Sub-Process	CMTS/ CCAP Priority	Event Message	Message Notes and Detail	Error Code Set	Event ID	Notification Name
Init	REGISTRATION REQUEST	Warning	Bad DS FREQ - Format Invalid<TAGS>		I105.0	73010500	CMTS: docsIf3CmtsEventNotif
Init	REGISTRATION REQUEST	Warning	Bad DS FREQ - Not in use<TAGS>		I105.1	73010501	CMTS: docsIf3CmtsEventNotif
Init	REGISTRATION REQUEST	Warning	Bad DS FREQ - Not Multiple of 62500 Hz<TAGS>		I105.2	73010502	CMTS: docsIf3CmtsEventNotif
Init	REGISTRATION REQUEST	Warning	Bad US CH - Invalid or Unassigned<TAGS>		I106.0	73010600	CMTS: docsIf3CmtsEventNotif
Init	REGISTRATION REQUEST	Warning	Bad US CH - Change followed with (RE-) Registration REQ<TAGS>		I106.1	73010601	CMTS: docsIf3CmtsEventNotif
Init	REGISTRATION REQUEST	Warning	Bad US CH - Overload<TAGS>		I107.0	73010700	CMTS: docsIf3CmtsEventNotif
Init	REGISTRATION REQUEST	Warning	Network Access has Invalid Parameter<TAGS>		I108.0	73010800	CMTS: docsIf3CmtsEventNotif
Init	REGISTRATION REQUEST	Warning	Bad Class of Service - Invalid Configuration<TAGS>		I109.0	73010900	CMTS: docsIf3CmtsEventNotif
Init	REGISTRATION REQUEST	Warning	Bad Class of Service - Unsupported class<TAGS>		I110.0	73011000	CMTS: docsIf3CmtsEventNotif
Init	REGISTRATION REQUEST	Warning	Bad Class of Service - Invalid class ID or out of range<TAGS>		I111.0	73011100	CMTS: docsIf3CmtsEventNotif
Init	REGISTRATION REQUEST	Warning	Bad Max DS Bit Rate - Invalid Format<TAGS>		I112.0	73011200	CMTS: docsIf3CmtsEventNotif
Init	REGISTRATION REQUEST	Warning	Bad Max DS Bit Rate Unsupported Setting<TAGS>		I112.1	73011201	CMTS: docsIf3CmtsEventNotif
Init	REGISTRATION REQUEST	Warning	Bad Max US Bit - Invalid Format<TAGS>		I113.0	73011300	CMTS: docsIf3CmtsEventNotif
Init	REGISTRATION REQUEST	Warning	Bad Max US Bit Rate - Unsupported Setting<TAGS>		I113.1	73011301	CMTS: docsIf3CmtsEventNotif
Init	REGISTRATION REQUEST	Warning	Bad US Priority Configuration - Invalid Format<TAGS>		I114.0	73011400	CMTS: docsIf3CmtsEventNotif
Init	REGISTRATION REQUEST	Warning	Bad US Priority Configuration - Setting out of Range<TAGS>		I114.1	73011401	CMTS: docsIf3CmtsEventNotif
Init	REGISTRATION REQUEST	Warning	Bad Guaranteed Min US CH Bit rate Configuration setting - Invalid Format<TAGS>		I115.0	73011500	CMTS: docsIf3CmtsEventNotif

Process	Sub-Process	CMTS/ CCAP Priority	Event Message	Message Notes and Detail	Error Code Set	Event ID	Notification Name
Init	REGISTRATION REQUEST	Warning	Bad Guaranteed Min US CH Bit rate Configuration setting - Exceed Max US Bit Rate<TAGS>		I115.1	73011501	CMTS: docsIf3CmtsEventNotif
Init	REGISTRATION REQUEST	Warning	Bad Guaranteed Min US CH Bit rate Configuration setting - Out of Range<TAGS>		I115.2	73011502	CMTS: docsIf3CmtsEventNotif
Init	REGISTRATION REQUEST	Warning	Bad Max US CH Transmit Burst configuration setting - Invalid Format<TAGS>		I116.0	73011600	CMTS: docsIf3CmtsEventNotif
Init	REGISTRATION REQUEST	Warning	Bad Max US CH Transmit Burst configuration setting - Out of Range<TAGS>		I116.1	73011601	CMTS: docsIf3CmtsEventNotif
Init	REGISTRATION REQUEST	Warning	Invalid Modem Capabilities configuration setting<TAGS>		I117.0	73011700	CMTS: docsIf3CmtsEventNotif
Init	REGISTRATION REQUEST	Warning	Configuration file contains parameter with the value outside of the range<TAGS>		I118.0	73011800	CMTS: docsIf3CmtsEventNotif
Init	1.1 and 2.0 SPECIFIC REGISTRATION REQUEST	Warning	REG REQ rejected - Unspecified reason<TAGS>		I201.0	73020100	CMTS: docsIf3CmtsEventNotif
Init	1.1 and 2.0 SPECIFIC REGISTRATION REQUEST	Warning	REG REQ rejected - Unrecognized configuration setting<TAGS>		I201.1	73020101	CMTS: docsIf3CmtsEventNotif
Init	1.1 and 2.0 SPECIFIC REGISTRATION REQUEST	Warning	REG REQ rejected - Major service flow error<TAGS>		I201.10	73020110	CMTS: docsIf3CmtsEventNotif
Init	1.1 and 2.0 SPECIFIC REGISTRATION REQUEST	Warning	REG REQ rejected - Major classifier error<TAGS>		I201.11	73020111	CMTS: docsIf3CmtsEventNotif
Init	1.1 and 2.0 SPECIFIC REGISTRATION REQUEST	Warning	REG REQ rejected - Multiple major errors<TAGS>		I201.13	73020113	CMTS: docsIf3CmtsEventNotif

Process	Sub-Process	CMTS/ CCAP Priority	Event Message	Message Notes and Detail	Error Code Set	Event ID	Notification Name
Init	1.1 and 2.0 SPECIFIC REGISTRATION REQUEST	Warning	REG REQ rejected - Message syntax error <P1><TAGS>	P1 = Message	I201.14	73020114	CMTS: docsIf3CmtsEventNotif
Init	1.1 and 2.0 SPECIFIC REGISTRATION REQUEST	Warning	REG REQ rejected - Primary service flow error <P1><TAGS>	P1 = Service Flow Reference	I201.15	73020115	CMTS: docsIf3CmtsEventNotif
Init	1.1 and 2.0 SPECIFIC REGISTRATION REQUEST	Warning	REG REQ rejected - temporary no resource<TAGS>		I201.2	73020102	CMTS: docsIf3CmtsEventNotif
Init	1.1 and 2.0 SPECIFIC REGISTRATION REQUEST	Warning	REG REQ rejected - Permanent administrative<TAGS>		I201.3	73020103	CMTS: docsIf3CmtsEventNotif
Init	1.1 and 2.0 SPECIFIC REGISTRATION REQUEST	Warning	REG REQ rejected - Required parameter not present <P1><TAGS>	P1 = TLV parameter	I201.4	73020104	CMTS: docsIf3CmtsEventNotif
Init	1.1 and 2.0 SPECIFIC REGISTRATION REQUEST	Warning	REG REQ rejected - Header suppression setting not supported<TAGS>		I201.5	73020105	CMTS: docsIf3CmtsEventNotif
Init	1.1 and 2.0 SPECIFIC REGISTRATION REQUEST	Warning	REG REQ rejected - Multiple errors<TAGS>		I201.6	73020106	CMTS: docsIf3CmtsEventNotif
Init	1.1 and 2.0 SPECIFIC REGISTRATION REQUEST	Warning	REG REQ rejected - duplicate reference-ID or index in message<TAGS>		I201.7	73020107	CMTS: docsIf3CmtsEventNotif
Init	1.1 and 2.0 SPECIFIC REGISTRATION REQUEST	Warning	REG REQ rejected - parameter invalid for context <P1><TAGS>	P1 = TLV parameter	I201.8	73020108	CMTS: docsIf3CmtsEventNotif
Init	1.1 and 2.0 SPECIFIC REGISTRATION REQUEST	Warning	REG REQ rejected - Authorization failure<TAGS>		I201.9	73020109	CMTS: docsIf3CmtsEventNotif

Process	Sub-Process	CMTS/ CCAP Priority	Event Message	Message Notes and Detail	Error Code Set	Event ID	Notification Name
Init	REGISTRATION ACKNOWLEDGEM ENT	Warning	REG aborted no REG- ACK<TAGS>		I301.0	73030100	CMTS: docsIf3CmtsEventNotif
Init	REGISTRATION Acknowledgement	Warning	REG ACK rejected unspecified reason<TAGS>		I302.0	73030200	CMTS: docsIf3CmtsEventNotif
Init	REGISTRATION ACKNOWLEDGEM ENT	Warning	REG ACK rejected message syntax error<TAGS>		I303.0	73030300	CMTS: docsIf3CmtsEventNotif
Init	1.1 and 2.0 SPECIFIC REGISTRATION REQUEST	Warning	REG REQ rejected - Message too big <P1><TAGS>	P1 = Number of characters	I201.16	73020116	CMTS: docsIf3CmtsEventNotif
Init	Waiting for REG- REQ or REG-REQ- MP	Warning	T9 Timeout - Never received REG-REQ or all REG-REQ-MP fragments<TAGS>		I211.0	73021100	
Init	CMTS Registration	Error	Missing RCP in REG-REQ or REG-REQ-MP<TAGS>		I551.0	73055100	
Init	CMTS Registration	Notice	Received Non-Queue-Depth Based Bandwidth Request and Multiple Transmit Channel mode is enabled<TAGS>		I552.0	73055200	
Init	CMTS Registration	Notice	Received Queue-Depth Based Bandwidth Request when Multiple Transmit Channel mode is not enabled<TAGS>		I553.0	73055300	
Init	CMTS Registration	Notice	Received REG-ACK with TCS - Partial Service<TAGS>		I554.0	73055400	
Init	CMTS Registration	Notice	Received REG-ACK with RCS - Partial Service<TAGS>		I555.0	73055500	
Init	CMTS Registration	Warning	T6 Timer expires and Retries Exceeded<TAGS>		I556.0	73055600	
Init	CMTS Registration	Warning	Initializing Channel Timeout<TAGS>		I557.0	73055700	
Init	CMTS Registration	Warning	REG-REQ-MP received when no MDD present<TAGS>		I558.0	73055800	
Init	CMTS Registration	Warning	REG-REQ rejected invalid Energy Management parameters<TAGS>		I559.0	73055900	



Process	Sub-Process	CMTS/ CCAP Priority	Event Message	Message Notes and Detail	Error Code Set	Event ID	Notification Name
<b>QoS</b>							
Service Flow	Service Flow Assignment	Notice	Attribute Masks for SF (SFID <P1>) do not satisfy those in the SCN <P2>	P1 = SFID P2 = SCN	K101.0	75010100	
<b>General</b>							
<b>Ranging</b>							
Init	RANGING	Warning	No Ranging Requests received from POLLED CM (CMTS generated polls);<CM-MAC>;		R101.0	82010100	
Init	RANGING	Warning	Retries exhausted for polled CM (report MAC address). After 16 R101.0 errors<CM-MAC>;		R102.0	82010200	
Init	RANGING	Warning	Unable to Successfully Range CM (report MAC address) Retries Exhausted;<CM-MAC>;	NOTE: this is different from R102.0 in that it was able to try, i.e., got REQs but failed to Range properly.	R103.0	82010300	
Init	RANGING	Warning	Failed to receive Periodic RNG- REQ from modem (SID X), timing-out SID;<CM-MAC>		R104.0	82010400	
Init	RANGING	Informational	CM transmitted B-INIT-RNG- REQ with MD-DS-SG ID of zero;<CM-MAC>	For CMTS SYSLOG only, append: MAC addr: <P1> P1 = Mac Addr of CM	R105.0	82010500	
<b>Dynamic Services</b>							
DYNAMIC SERVICES	DYNAMIC SERVICE REQUEST	Warning	Service Add rejected - Unspecified reason<TAGS>		S01.0	83000100	CMTS: docsIf3CmtsEventNotif
DYNAMIC SERVICES	DYNAMIC SERVICE REQUEST	Warning	Service Add rejected - Unrecognized configuration setting<TAGS>		S01.1	83000101	CMTS: docsIf3CmtsEventNotif
DYNAMIC SERVICES	DYNAMIC SERVICE REQUEST	Warning	Service Add rejected - Classifier not found<TAGS>		S01.10	83000110	CMTS: docsIf3CmtsEventNotif
DYNAMIC SERVICES	DYNAMIC SERVICE REQUEST	Warning	Service Add rejected - Classifier exists<TAGS>		S01.11	83000111	CMTS: docsIf3CmtsEventNotif
DYNAMIC SERVICES	DYNAMIC SERVICE REQUEST	Warning	Service Add rejected - Duplicated reference-ID or index in message<TAGS>		S01.14	83000114	CMTS: docsIf3CmtsEventNotif
DYNAMIC SERVICES	DYNAMIC SERVICE REQUEST	Warning	Service Add rejected - Multiple upstream flows<TAGS>		S01.15	83000115	CMTS: docsIf3CmtsEventNotif

Process	Sub-Process	CMTS/ CCAP Priority	Event Message	Message Notes and Detail	Error Code Set	Event ID	Notification Name
DYNAMIC SERVICES	DYNAMIC SERVICE REQUEST	Warning	Service Add rejected - Multiple downstream flows<TAGS>		S01.16	83000116	CMTS: docsIf3CmtsEventNotif
DYNAMIC SERVICES	DYNAMIC SERVICE REQUEST	Warning	Service Add rejected - Classifier for another flow<TAGS>		S01.17	83000117	CMTS: docsIf3CmtsEventNotif
DYNAMIC SERVICES	DYNAMIC SERVICE REQUEST	Warning	Service Add rejected - Parameter invalid for context<TAGS>		S01.19	83000119	CMTS: docsIf3CmtsEventNotif
DYNAMIC SERVICES	DYNAMIC SERVICE REQUEST	Warning	Service Add rejected - Temporary no resource<TAGS>		S01.2	83000102	CMTS: docsIf3CmtsEventNotif
DYNAMIC SERVICES	DYNAMIC SERVICE REQUEST	Warning	Service Add rejected - Authorization failure<TAGS>		S01.20	83000120	CMTS: docsIf3CmtsEventNotif
DYNAMIC SERVICES	DYNAMIC SERVICE REQUEST	Warning	Service Add rejected - Major service flow error<TAGS>		S01.21	83000121	CMTS: docsIf3CmtsEventNotif
DYNAMIC SERVICES	DYNAMIC SERVICE REQUEST	Warning	Service Add rejected - Major classifier error<TAGS>		S01.22	83000122	CMTS: docsIf3CmtsEventNotif
DYNAMIC SERVICES	DYNAMIC SERVICE REQUEST	Warning	Service Add rejected - Multiple major errors<TAGS>		S01.24	83000124	CMTS: docsIf3CmtsEventNotif
DYNAMIC SERVICES	DYNAMIC SERVICE REQUEST	Warning	Service Add rejected - Message syntax error<TAGS>		S01.25	83000125	CMTS: docsIf3CmtsEventNotif
DYNAMIC SERVICES	DYNAMIC SERVICE REQUEST	Warning	Service Add rejected - Message too big<TAGS>		S01.26	83000126	CMTS: docsIf3CmtsEventNotif
DYNAMIC SERVICES	DYNAMIC SERVICE REQUEST	Warning	Service Add rejected - Temporary DCC<TAGS>		S01.27	83000127	CMTS: docsIf3CmtsEventNotif
DYNAMIC SERVICES	DYNAMIC SERVICE REQUEST	Warning	Service Add rejected - Permanent administrative<TAGS>		S01.3	83000103	CMTS: docsIf3CmtsEventNotif
DYNAMIC SERVICES	DYNAMIC SERVICE REQUEST	Warning	Service Add rejected - Required parameter not present<TAGS>		S01.4	83000104	CMTS: docsIf3CmtsEventNotif
DYNAMIC SERVICES	DYNAMIC SERVICE REQUEST	Warning	Service Add rejected - Header suppression setting not supported<TAGS>		S01.5	83000105	CMTS: docsIf3CmtsEventNotif
DYNAMIC SERVICES	DYNAMIC SERVICE REQUEST	Warning	Service Add rejected - Service flow exists<TAGS>		S01.6	83000106	CMTS: docsIf3CmtsEventNotif
DYNAMIC SERVICES	DYNAMIC SERVICE REQUEST	Warning	Service Add rejected - HMAC Auth failure<TAGS>		S01.7	83000107	CMTS: docsIf3CmtsEventNotif
DYNAMIC SERVICES	DYNAMIC SERVICE REQUEST	Warning	Service Add rejected - Add aborted<TAGS>		S01.8	83000108	CMTS: docsIf3CmtsEventNotif
DYNAMIC SERVICES	DYNAMIC SERVICE REQUEST	Warning	Service Add rejected - Multiple errors<TAGS>		S01.9	83000109	CMTS: docsIf3CmtsEventNotif

Process	Sub-Process	CMTS/ CCAP Priority	Event Message	Message Notes and Detail	Error Code Set	Event ID	Notification Name
DYNAMIC SERVICES	DYNAMIC SERVICE REQUEST	Warning	Service Change rejected - Unspecified reason<TAGS>		S02.0	83000200	CMTS: docsIf3CmtsEventNotif
DYNAMIC SERVICES	DYNAMIC SERVICE REQUEST	Warning	Service Change rejected - Unrecognized configuration setting<TAGS>		S02.1	83000201	CMTS: docsIf3CmtsEventNotif
DYNAMIC SERVICES	DYNAMIC SERVICE REQUEST	Warning	Service Change rejected - Classifier not found<TAGS>		S02.10	83000210	CMTS: docsIf3CmtsEventNotif
DYNAMIC SERVICES	DYNAMIC SERVICE REQUEST	Warning	Service Change rejected - Classifier exists<TAGS>		S02.11	83000211	CMTS: docsIf3CmtsEventNotif
DYNAMIC SERVICES	DYNAMIC SERVICE REQUEST	Warning	Service Change rejected - Duplicated reference-ID or index in message<TAGS>		S02.14	83000214	CMTS: docsIf3CmtsEventNotif
DYNAMIC SERVICES	DYNAMIC SERVICE REQUEST	Warning	Service Change rejected - Multiple upstream flows<TAGS>		S02.15	83000215	CMTS: docsIf3CmtsEventNotif
DYNAMIC SERVICES	DYNAMIC SERVICE REQUEST	Warning	Service Change rejected - Multiple downstream flows<TAGS>		S02.16	83000216	CMTS: docsIf3CmtsEventNotif
DYNAMIC SERVICES	DYNAMIC SERVICE REQUEST	Warning	Service Change rejected - Classifier for another flow<TAGS>		S02.17	83000217	CMTS: docsIf3CmtsEventNotif
DYNAMIC SERVICES	DYNAMIC SERVICE REQUEST	Warning	Service Change rejected - Invalid parameter for context<TAGS>		S02.19	83000219	CMTS: docsIf3CmtsEventNotif
DYNAMIC SERVICES	DYNAMIC SERVICE REQUEST	Warning	Service Change rejected - Temporary no resource<TAGS>		S02.2	83000202	CMTS: docsIf3CmtsEventNotif
DYNAMIC SERVICES	DYNAMIC SERVICE REQUEST	Warning	Service Change rejected - Authorization failure<TAGS>		S02.20	83000220	CMTS: docsIf3CmtsEventNotif
DYNAMIC SERVICES	DYNAMIC SERVICE REQUEST	Warning	Service Change rejected - Major service flow error<TAGS>		S02.21	83000221	CMTS: docsIf3CmtsEventNotif
DYNAMIC SERVICES	DYNAMIC SERVICE REQUEST	Warning	Service Change rejected -Major classifier error<TAGS>		S02.22	83000222	CMTS: docsIf3CmtsEventNotif
DYNAMIC SERVICES	DYNAMIC SERVICE REQUEST	Warning	Service Change rejected - Multiple major errors<TAGS>		S02.24	83000224	CMTS: docsIf3CmtsEventNotif
DYNAMIC SERVICES	DYNAMIC SERVICE REQUEST	Warning	Service Change rejected - Message syntax error<TAGS>		S02.25	83000225	CMTS: docsIf3CmtsEventNotif
DYNAMIC SERVICES	DYNAMIC SERVICE REQUEST	Warning	Service Change rejected - Message too big<TAGS>		S02.26	83000226	CMTS: docsIf3CmtsEventNotif
DYNAMIC SERVICES	DYNAMIC SERVICE REQUEST	Warning	Service Change rejected - Temporary DCC<TAGS>		S02.27	83000227	CMTS: docsIf3CmtsEventNotif

Process	Sub-Process	CMTS/ CCAP Priority	Event Message	Message Notes and Detail	Error Code Set	Event ID	Notification Name
DYNAMIC SERVICES	DYNAMIC SERVICE REQUEST	Warning	Service Change rejected - Permanent administrative<TAGS>		S02.3	83000203	CMTS: docsIf3CmtsEventNotif
DYNAMIC SERVICES	DYNAMIC SERVICE REQUEST	Warning	Service Change rejected - Requester not owner of service flow<TAGS>		S02.4	83000204	CMTS: docsIf3CmtsEventNotif
DYNAMIC SERVICES	DYNAMIC SERVICE REQUEST	Warning	Service Change rejected - Service flow not found<TAGS>		S02.5	83000205	CMTS: docsIf3CmtsEventNotif
DYNAMIC SERVICES	DYNAMIC SERVICE REQUEST	Warning	Service Change rejected - Required parameter not present<TAGS>		S02.6	83000206	CMTS: docsIf3CmtsEventNotif
DYNAMIC SERVICES	DYNAMIC SERVICE REQUEST	Warning	Service Change rejected - Header suppression setting not supported<TAGS>		S02.7	83000207	CMTS: docsIf3CmtsEventNotif
DYNAMIC SERVICES	DYNAMIC SERVICE REQUEST	Warning	Service Change rejected - HMAC Auth failure<TAGS>		S02.8	83000208	CMTS: docsIf3CmtsEventNotif
DYNAMIC SERVICES	DYNAMIC SERVICE REQUEST	Warning	Service Change rejected - Multiple errors<TAGS>		S02.9	83000209	CMTS: docsIf3CmtsEventNotif
DYNAMIC SERVICES	DYNAMIC SERVICE REQUEST	Warning	Service Delete rejected - Unspecified reason<TAGS>		S03.0	83000300	CMTS: docsIf3CmtsEventNotif
DYNAMIC SERVICES	DYNAMIC SERVICE REQUEST	Warning	Service Delete rejected - Requester not owner of service flow<TAGS>		S03.1	83000301	CMTS: docsIf3CmtsEventNotif
DYNAMIC SERVICES	DYNAMIC SERVICE REQUEST	Warning	Service Delete rejected - Service flow not found<TAGS>		S03.2	83000302	CMTS: docsIf3CmtsEventNotif
DYNAMIC SERVICES	DYNAMIC SERVICE REQUEST	Warning	Service Delete rejected - HMAC Auth failure<TAGS>		S03.3	83000303	CMTS: docsIf3CmtsEventNotif
DYNAMIC SERVICES	DYNAMIC SERVICE REQUEST	Warning	Service Delete rejected - Message syntax error<TAGS>		S03.4	83000304	CMTS: docsIf3CmtsEventNotif
DYNAMIC SERVICES	DYNAMIC SERVICE RESPONSE	Warning	Service Add Response rejected - Invalid transaction ID<TAGS>		S101.0	83010100	CMTS: docsIf3CmtsEventNotif
DYNAMIC SERVICES	DYNAMIC SERVICE RESPONSE	Warning	Service Add aborted - No RSP<TAGS>		S101.1	83010101	CMTS: docsIf3CmtsEventNotif
DYNAMIC SERVICES	DYNAMIC SERVICE RESPONSE	Warning	Service Add Response rejected - Duplicate reference_ID or index in message<TAGS>		S101.11	83010111	CMTS: docsIf3CmtsEventNotif
DYNAMIC SERVICES	DYNAMIC SERVICE RESPONSE	Warning	Service Add Response rejected - Classifier for another flow<TAGS>		S101.12	83010112	CMTS: docsIf3CmtsEventNotif

Process	Sub-Process	CMTS/ CCAP Priority	Event Message	Message Notes and Detail	Error Code Set	Event ID	Notification Name
DYNAMIC SERVICES	DYNAMIC SERVICE RESPONSE	Warning	Service Add Response rejected - Parameter invalid for context<TAGS>		S101.13	83010113	CMTS: docsIf3CmtsEventNotif
DYNAMIC SERVICES	DYNAMIC SERVICE RESPONSE	Warning	Service Add Response rejected - Major service flow error<TAGS>		S101.14	83010114	CMTS: docsIf3CmtsEventNotif
DYNAMIC SERVICES	DYNAMIC SERVICE RESPONSE	Warning	Service Add Response rejected - Major classifier error<TAGS>		S101.15	83010115	CMTS: docsIf3CmtsEventNotif
DYNAMIC SERVICES	DYNAMIC SERVICE RESPONSE	Warning	Service Add Response rejected - Multiple major errors<TAGS>		S101.17	83010117	CMTS: docsIf3CmtsEventNotif
DYNAMIC SERVICES	DYNAMIC SERVICE RESPONSE	Warning	Service Add Response rejected - Message too big<TAGS>		S101.18	83010118	CMTS: docsIf3CmtsEventNotif
DYNAMIC SERVICES	DYNAMIC SERVICE RESPONSE	Warning	Service Add Response rejected - HMAC Auth failure<TAGS>		S101.2	83010102	CMTS: docsIf3CmtsEventNotif
DYNAMIC SERVICES	DYNAMIC SERVICE RESPONSE	Warning	Service Add Response rejected - Message syntax error<TAGS>		S101.3	83010103	CMTS: docsIf3CmtsEventNotif
DYNAMIC SERVICES	DYNAMIC SERVICE RESPONSE	Warning	Service Add Response rejected - Unspecified reason<TAGS>		S101.4	83010104	CMTS: docsIf3CmtsEventNotif
DYNAMIC SERVICES	DYNAMIC SERVICE RESPONSE	Warning	Service Add Response rejected - Unrecognized configuration setting<TAGS>		S101.5	83010105	CMTS: docsIf3CmtsEventNotif
DYNAMIC SERVICES	DYNAMIC SERVICE RESPONSE	Warning	Service Add Response rejected - Required parameter not present<TAGS>		S101.6	83010106	CMTS: docsIf3CmtsEventNotif
DYNAMIC SERVICES	DYNAMIC SERVICE RESPONSE	Warning	Service Add Response rejected - Service Flow exists<TAGS>		S101.7	83010107	CMTS: docsIf3CmtsEventNotif
DYNAMIC SERVICES	DYNAMIC SERVICE RESPONSE	Warning	Service Add Response rejected - Multiple errors<TAGS>		S101.8	83010108	CMTS: docsIf3CmtsEventNotif
DYNAMIC SERVICES	DYNAMIC SERVICE RESPONSE	Warning	Service Add Response rejected - Classifier exists<TAGS>		S101.9	83010109	CMTS: docsIf3CmtsEventNotif
DYNAMIC SERVICES	DYNAMIC SERVICE RESPONSE	Warning	Service Change Response rejected - Invalid transaction ID<TAGS>		S102.0	83010200	CMTS: docsIf3CmtsEventNotif
DYNAMIC SERVICES	DYNAMIC SERVICE RESPONSE	Warning	Service Change aborted- No RSP<TAGS>		S102.1	83010201	CMTS: docsIf3CmtsEventNotif
DYNAMIC SERVICES	DYNAMIC SERVICE RESPONSE	Warning	Service Change Response rejected - Duplicated reference-ID or index in<TAGS>		S102.10	83010210	CMTS: docsIf3CmtsEventNotif

Process	Sub-Process	CMTS/ CCAP Priority	Event Message	Message Notes and Detail	Error Code Set	Event ID	Notification Name
DYNAMIC SERVICES	DYNAMIC SERVICE RESPONSE	Warning	Service Change Response rejected - Invalid parameter for context<TAGS>		S102.11	83010211	CMTS: docsIf3CmtsEventNotif
DYNAMIC SERVICES	DYNAMIC SERVICE RESPONSE	Warning	Service Change Response rejected - Major classifier error<TAGS>		S102.12	83010212	CMTS: docsIf3CmtsEventNotif
DYNAMIC SERVICES	DYNAMIC SERVICE RESPONSE	Warning	Service Change Response rejected - Multiple Major errors<TAGS>		S102.14	83010214	CMTS: docsIf3CmtsEventNotif
DYNAMIC SERVICES	DYNAMIC SERVICE RESPONSE	Warning	Service Change Response rejected - Message too big<TAGS>		S102.15	83010215	CMTS: docsIf3CmtsEventNotif
DYNAMIC SERVICES	DYNAMIC SERVICE RESPONSE	Warning	Service Change Response rejected - HMAC Auth failure<TAGS>		S102.2	83010202	CMTS: docsIf3CmtsEventNotif
DYNAMIC SERVICES	DYNAMIC SERVICE RESPONSE	Warning	Service Change Response rejected - Message syntax error<TAGS>		S102.3	83010203	CMTS: docsIf3CmtsEventNotif
DYNAMIC SERVICES	DYNAMIC SERVICE RESPONSE	Warning	Service Change Response rejected - Unspecified reason<TAGS>		S102.4	83010204	CMTS: docsIf3CmtsEventNotif
DYNAMIC SERVICES	DYNAMIC SERVICE RESPONSE	Warning	Service Change Response rejected - Unrecognized configuration setting<TAGS>		S102.5	83010205	CMTS: docsIf3CmtsEventNotif
DYNAMIC SERVICES	DYNAMIC SERVICE RESPONSE	Warning	Service Change Response rejected - Required parameter not present<TAGS>		S102.6	83010206	CMTS: docsIf3CmtsEventNotif
DYNAMIC SERVICES	DYNAMIC SERVICE RESPONSE	Warning	Service Change Response rejected - Multiple errors<TAGS>		S102.7	83010207	CMTS: docsIf3CmtsEventNotif
DYNAMIC SERVICES	DYNAMIC SERVICE RESPONSE	Warning	Service Change Response rejected - Classifier exists<TAGS>		S102.8	83010208	CMTS: docsIf3CmtsEventNotif
DYNAMIC SERVICES	DYNAMIC SERVICE RESPONSE	Warning	Service Delete Response rejected - Invalid transaction ID<TAGS>		S103.0	83010300	CMTS: docsIf3CmtsEventNotif
DYNAMIC SERVICES	DYNAMIC SERVICE ACKNOWLEDGEMENT	Warning	Service Add Response rejected - Invalid Transaction ID<TAGS>		S201.0	83020100	CMTS: docsIf3CmtsEventNotif

Process	Sub-Process	CMTS/ CCAP Priority	Event Message	Message Notes and Detail	Error Code Set	Event ID	Notification Name
DYNAMIC SERVICES	DYNAMIC SERVICE ACKNOWLEDGEMENT	Warning	Service Add Aborted - No ACK<TAGS>		S201.1	83020101	CMTS: docsIf3CmtsEventNotif
DYNAMIC SERVICES	DYNAMIC SERVICE ACKNOWLEDGEMENT	Warning	Service Add ACK rejected - HMAC auth failure<TAGS>		S201.2	83020102	CMTS: docsIf3CmtsEventNotif
DYNAMIC SERVICES	DYNAMIC SERVICE ACKNOWLEDGEMENT	Warning	Service Add ACK rejected-Message syntax error<TAGS>		S201.3	83020103	CMTS: docsIf3CmtsEventNotif
DYNAMIC SERVICES	DYNAMIC SERVICE ACKNOWLEDGEMENT	Warning	Service Change ACK rejected - Invalid transaction ID<TAGS>		S202.0	83020200	CMTS: docsIf3CmtsEventNotif
DYNAMIC SERVICES	DYNAMIC SERVICE ACKNOWLEDGEMENT	Warning	Service Change Aborted - No ACK<TAGS>		S202.1	83020201	CMTS: docsIf3CmtsEventNotif
DYNAMIC SERVICES	DYNAMIC SERVICE ACKNOWLEDGEMENT	Warning	Service Change ACK rejected - HMAC Auth failure<TAGS>		S202.2	83020202	CMTS: docsIf3CmtsEventNotif
DYNAMIC SERVICES	DYNAMIC SERVICE ACKNOWLEDGEMENT	Warning	Service Change ACK rejected - Message syntax error<TAGS>		S202.3	83020203	CMTS: docsIf3CmtsEventNotif
<b>Downstream Acquisition</b>							
<b>Diagnostic Log</b>							
Diag	LogSize	Warning	Diagnostic log size reached high threshold. Enabled detectors: <P1>;Log maximum size: <P2>	P1 = (ASCII hex representation of enabled diagnostic log detectors bit mask) P2 = maximum size of the diagnostic log	V001.0	86000100	docsDiagLogSizeHighThrsldReached
Diag	LogSize	Notice	Diagnostic log size dropped to low threshold. Enabled detectors: <P1>;Log maximum size: <P2>	P1 = (ASCII hex representation of enabled diagnostic log detectors bit mask) P2 = maximum size of the diagnostic log	V002.0	86000200	docsDiagLogSizeLowThrsldReached
Diag	LogSize	Warning	Diagnostic log size reached full threshold. Enabled detectors: <P1>;Log maximum size: <P2>	P1 = (ASCII hex representation of enabled diagnostic log detectors bit mask) P2 = maximum size of the diagnostic log	V003.0	86000300	docsDiagLogSizeFull

Process	Sub-Process	CMTS/ CCAP Priority	Event Message	Message Notes and Detail	Error Code Set	Event ID	Notification Name
<b>IPDR</b>							
IPDR	IPDR/SP Protocol	Notice	IPDR Connection Terminated. Collector IP: <P1>; Session ID: <P2>; Error Code: <P3>; Error Description: <P4>	P1 = Collector Host Name P2 = Session ID P3 = Error Code P4 = Error Description	W001.0	87000100	
IPDR	IPDR/SP Redundancy	Warning	IPDR Collector Failover Error: Backup Collector IP: <P1>;	P1 = Backup Collector IP	W002.0	87000200	
<b>Multicast</b>							
Multicast	QoS	Warning	Aggregate Session Limit defined by GC, GQC entry (<P1>) exceeded by join for <P2><TAGS>	P1 = GC ID, GQC ID P2 = S, G of the join  Note: The event only records the CM MAC Addr though the Join could be from a CM or a CPE behind it.	Y101.0	89010100	CMTS: docsIf3CmtsEventNotif
Multicast	QoS	Warning	Admitted Multicast Aggregate Bandwidth Increased Above Low Water Mark <P1> on Interface <P2>:<P3><TAGS>	P1 = Low Water Mark Threshold P2 = ifName.ifIndex P3 = ifIndex	Y101.1	89010101	CMTS: docsIf3CmtsEventNotif
Multicast	QoS	Notice	Admitted Multicast Aggregate Bandwidth Dropped Below Low Water Mark <P1> on Interface <P2>:<P3><TAGS>	P1 = Low Water Mark Threshold P2 = ifName.ifIndex P3 = ifIndex	Y101.2	89010102	CMTS: docsIf3CmtsEventNotif
Multicast	QoS	Error	Admitted Multicast Aggregate Bandwidth Increased to High Water Mark <P1> on Interface <P2>:<P3><TAGS>	P1 = High Water Mark Threshold P2 = ifName.ifIndex P3 = ifIndex	Y101.3	89010103	CMTS: docsIf3CmtsEventNotif
Multicast	QoS	Warning	Multicast Group Service Flow <P1> on Interface <P2>:<P3> Dropping Packets;<P4>:<P5>:<P6><TAG S>	P1 = Service Flow ID associated with GSF P2 = MAC Domain ifName.ifIndex P3 = MAC Domain ifIndex P4 = Service Class Name P5 = Max Traffic Rate P6 = GC ID, GQC ID	Y101.4	89010104	CMTS: docsIf3CmtsEventNotif



Process	Sub-Process	CMTS/ CCAP Priority	Event Message	Message Notes and Detail	Error Code Set	Event ID	Notification Name
Multicast	QoS	Notice	Multicast Group Service Flow <P1> on Interface <P2>:<P3> No Longer Dropping Packets;<P4>:<P5>:<P6><TAG S>	P1 = Service Flow ID associated with GSF P2 = MAC Domain ifName.ifIndex P3 = MAC Domain ifIndex P4 = Service Class Name P5 = Max Traffic Rate P6 = GC ID, GQC ID	Y101.5	89010105	CMTS: docsIf3CmtsEventNotif
Multicast	QoS	Warning	Ingress IGMP Protocol Messages Increased to Threshold <P1> on Interface <P2>:<P3><TAGS>	P1 = Threshold P2 = MAC Domain ifName.ifIndex P3 = MAC Domain ifIndex	Y101.6	89010106	CMTS: docsIf3CmtsEventNotif
Multicast	QoS	Notice	Ingress IGMP Protocol Messages Dropped Below Threshold <P1> on Interface <P2>:<P3><TAGS>	P1 = Threshold P2 = MAC Domain ifName.ifIndex P3 = MAC Domain ifIndex	Y101.7	89010107	CMTS: docsIf3CmtsEventNotif
Multicast	QoS	Warning	Ingress MLD Protocol Messages Increased to Threshold <P1> on Interface <P2>:<P3><TAGS>	P1 = Threshold P2 = MAC Domain ifName.ifIndex P3 = MAC Domain ifIndex	Y101.8	89010108	CMTS: docsIf3CmtsEventNotif
Multicast	QoS	Notice	Ingress MLD Protocol Messages Dropped Below Threshold <P1> on Interface <P2>:<P3><TAGS>	P1 = Threshold P2 = MAC Domain ifName.ifIndex P3 = MAC Domain ifIndex	Y101.9	89010109	CMTS: docsIf3CmtsEventNotif
Multicast	Authorization	Notice	Multicast session <P1> not authorized for Client <P2> behind CM <P3><TAGS>	P1 = S,G of the join P2 = IPv4 or IPv6 Address of Client P3 = CM MAC Addr	Y102.0	89010200	CMTS: docsIf3CmtsEventNotif
Multicast	Authorization	Warning	Maximum Multicast Session <P1> Threshold <P2> Reached for CM <P3><TAGS>	P1 = S,G of the join P2 = Multicast Session Limit P3 = CM MAC Addr	Y102.1	89010201	CMTS: docsIf3CmtsEventNotif
Multicast	Authorization	Informational	Multicast Profile <P1> created for CM <P2><TAGS>	P1 = Profile Name P2 = CM MAC Addr	Y103.0	89010300	CMTS: docsIf3CmtsEventNotif
<b>CM-STATUS</b>							
CM-STATUS	CM-STATUS	Notice	CM-STATUS received prior to REG-ACK<TAGS>		J01.0	74000100	CMTS: docsIf3CmtsEventNotif
CM-STATUS	CM-STATUS	Notice	CM-STATUS received while enable bit cleared<TAGS>		J02.0	74000200	CMTS: docsIf3CmtsEventNotif

Process	Sub-Process	CMTS/ CCAP Priority	Event Message	Message Notes and Detail	Error Code Set	Event ID	Notification Name
CM-STATUS	CM-STATUS	Notice	CM-STATUS received - secondary channel MDD timeout<TAGS>		J03.0	74000300	CMTS: docsIf3CmtsEventNotif
CM-STATUS	CM-STATUS	Notice	CM-STATUS received - QAM/FEC lock failure<TAGS>		J04.0	74000400	CMTS: docsIf3CmtsEventNotif
CM-STATUS	CM-STATUS	Notice	CM-STATUS received - sequence out-of-range<TAGS>		J05.0	74000500	CMTS: docsIf3CmtsEventNotif
CM-STATUS	CM-STATUS	Notice	CM-STATUS received - MDD recovery<TAGS>		J06.0	74000600	CMTS: docsIf3CmtsEventNotif
CM-STATUS	CM-STATUS	Notice	CM-STATUS received - QAM/FEC recovery<TAGS>		J07.0	74000700	CMTS: docsIf3CmtsEventNotif
CM-STATUS	CM-STATUS	Notice	CM-STATUS received - T4 timeout<TAGS>		J08.0	74000800	CMTS: docsIf3CmtsEventNotif
CM-STATUS	CM-STATUS	Notice	CM-STATUS received - T3 retries exceeded<TAGS>		J09.0	74000900	CMTS: docsIf3CmtsEventNotif
CM-STATUS	CM-STATUS	Notice	CM-STATUS received - DS OFDM profile failure<TAGS>		J10.0	74001000	CMTS: docsIf3CmtsEventNotif
CM-STATUS	CM-STATUS	Notice	CM-STATUS received - Primary DS change<TAGS>		J11.0	74001100	CMTS: docsIf3CmtsEventNotif
CM-STATUS	CM-STATUS	Notice	CM-STATUS received - DPD out of sync<TAGS>		J12.0	74001200	CMTS: docsIf3CmtsEventNotif
CM-STATUS	CM-STATUS	Notice	CM-STATUS received - Invalid DPD<TAGS>		J13.0	74001300	CMTS: docsIf3CmtsEventNotif
CM-STATUS	CM-STATUS	Notice	CM-STATUS received - NCP profile failure<TAGS>		J14.0	74001400	CMTS: docsIf3CmtsEventNotif
CM-STATUS	CM-STATUS	Notice	CM-STATUS received - Loss of PLC channel<TAGS>		J15.0	74001500	CMTS: docsIf3CmtsEventNotif
CM-STATUS	CM-STATUS	Notice	CM-STATUS received - Loss of data on all profiles<TAGS>		J16.0	74001600	CMTS: docsIf3CmtsEventNotif
CM-STATUS	CM-STATUS	Notice	CM-STATUS received – US OFDMA profile failure <TAGS>		J17.0	74001700	CMTS: docsIf3CmtsEventNotif
CM-STATUS	CM-STATUS	Notice	CM-STATUS received – MAP storage overflow<TAGS>		J18.0	74001800	CMTS: docsIf3CmtsEventNotif
CM-STATUS	CM-STATUS	Notice	CM-STATUS received – MAP storage almost full<TAGS>		J19.0	74001900	CMTS: docsIf3CmtsEventNotif

Process	Sub-Process	CMTS/ CCAP Priority	Event Message	Message Notes and Detail	Error Code Set	Event ID	Notification Name
<b>CM-CTRL</b>							
CM-CTRL	CM-CTRL	Debug	CM-CTRL - Command: <P1> (if P1= mute Add Interval: <P2> ChannelID: <P3>) (If P1 = forwarding Add Action: <P4>) <TAGS>	P1 = mute, or cmReinit, or forwarding P2= mute interval, Value 0 indicate unmute operation P3= Channel ID or 0 P4 = enable, or disable	L01.0	76000100	CMTS: docsIf3CmtsEventNotif
CM-CTRL	CM-CTRL	Debug	CM-CTRL- Invalid message format<TAGS>		L02.0	76000200	CMTS: docsIf3CmtsEventNotif
<b>Energy Management</b>							
EM	EM-RSP	Warning	EM-RSP sent, Reject Temporary: Bonded Multicast Conflict<TAGS>		L105.0	76010500	
EM	EM-RSP	Warning	EM-RSP sent, Reject Temporary: UGS/RTPS Grant Conflict<TAGS>		L106.0	76010600	
EM	EM-RSP	Warning	EM-RSP sent, Reject Temporary: Attribute Mask Conflict<TAGS>		L107.0	76010700	
EM	EM-RSP	Warning	EM-RSP sent, Reject Temporary: Deferred<TAGS>		L108.0	76010800	
EM	EM-RSP	Warning	EM-RSP sent, Reject Permanent, Requested Low Power Mode(s) Not Supported<TAGS>		L109.0	76010900	
EM	EM-RSP	Warning	EM-RSP sent, Reject Permanent, Requested Low Power Mode(s) Disabled<TAGS>		L110.0	76011000	
EM	EM-RSP	Warning	EM-RSP sent, Reject Permanent, Other<TAGS>		L111.0	76011100	
EM	EM-RSP	Notice	CM allowed into 1x1 Mode while Attribute Masks not met<TAGS>		L112.0	76011200	
EM	DBC	Informational	CM entered EM 1x1 mode; Reason: <P1><TAGS>	P1=Unknown, Activity Detection, eSAFE, CMTS Initiated	L113.0	76011300	CMTS: docsIf3CmtsEventNotif

Process	Sub-Process	CMTS/ CCAP Priority	Event Message	Message Notes and Detail	Error Code Set	Event ID	Notification Name
EM	DBC	Informational	CM exited EM 1x1 mode<TAGS>		L114.0	76011400	CMTS: docsIf3CmtsEventNotif
<b>Data Collection</b>							
Data Collection	Data File	Warning	Bulk data file size reached high threshold. Data collection type: <P1>; Filename: <P2>; File maximum size: <P3>	P1 = (Type of data collection such as PNM test type, e.g., Upstream Triggered Spectrum Capture) P2 = Filename assigned to the PNM data file P3 = maximum size of PNM capture file in bytes	F007.1	70000701	docsIf3CmtsEventNotif
Data Collection	Data File	Warning	Bulk data file size reached full threshold. Data collection type: <P1>; Filename: <P2>; File maximum size: <P3>	P1 = (Type of data collection such as PNM test type, e.g., Upstream Triggered Spectrum Capture) P2 = Filename assigned to the PNM data file P3 = maximum size of PNM capture file in bytes	F007.2	70000702	docsIf3CmtsEventNotif
<b>DSG Reserved Events (See [DSG] for Event Definitions)</b>							
					Gxxx.xx		
<b>eDOCSIS Reserved Events (See [eDOCSIS] for Event Definitions)</b>							
					Hxxx.xx		
<b>M-CMTS Reserved Events (See [M-OSSI] for Event Definitions)</b>							
					Mxxx.xx		
<b>DPoE Reserved Events (See [DPoE OSSlv2.0] for Event Definitions)</b>							
					Pxxx.xx		
<b>EQAM Reserved Events (See [PMI] for Event Definitions)</b>							
					Qxxx.xx		

**Table D-2 - CCAP Events<sup>241</sup>**

Process	Sub-Process	CCAP Priority	Event Message	Message Notes and Details	Error Code Set	Event ID	Trap Name
<b>CCAP XML Configuration File Processing</b>							
CCAP-Config	Login	Error	Inbound interactive login failed: Protocol: <P1>, Username: <P2>	P1=Protocol from IntegratedServers ServerType attribute (section 6.6.7.5) P2=Username	F001.1	70000101	docslf3CmtsEventNotif
CCAP-Config	File Transfer	Error	File transfer failed: Protocol: <P1>, Username: <P2>, Destination host/path: <P3>:<P4>	P1=Protocol from Section 6.3.7, File Transfer Mechanisms P2=Username P3=Destination host name or IP address P4=Path to filename	F001.2	70000102	docslf3CmtsEventNotif
CCAP-Config	Validate	Info	XML Configuration File - Validation Passed: <P1>	P1=configuration file name	F001.3	70000103	docslf3CmtsEventNotif
CCAP-Config	Validate	Notice	XML Configuration File - Validation Failed: <P1>	P1=configuration file name	F001.4	70000104	docslf3CmtsEventNotif
CCAP-Config	Execute	Notice	XML Configuration File - Execution Success: <P1>	P1=configuration file name	F001.5	70000105	docslf3CmtsEventNotif
CCAP-Config	Validate	Error	XML Configuration File - Unsupported Cipher Algorithms - Configuration Continued: <P1>;<P2>	P1=configuration file name, P2=unsupported Cipher algorithm(s)	F001.10	70000110	docslf3CmtsEventNotif
CCAP-Config	Validate	Error	XML Configuration File - Unsupported Message Authentication Algorithms - Configuration Continued: <P1>;<P2>	P1=configuration file name, P2=unsupported Message Authentication algorithm(s)	F001.11	70000111	docslf3CmtsEventNotif
CCAP-Config	Execute	Error	XML Configuration File - Unsupported Elements - Configuration Continued: <P1>	P1=configuration file name	F001.6	70000106	docslf3CmtsEventNotif
CCAP-Config	Execute	Error	XML Configuration File - Non-fatal Error - Configuration Continued: <P1>	P1=configuration file name	F001.7	70000107	docslf3CmtsEventNotif
CCAP-Config	Execute	Warning	XML Configuration File - Fatal Operation Value Error - Configuration Aborted: <P1>	P1=configuration file name	F001.8	70000108	docslf3CmtsEventNotif
CCAP-Config	Execute	Warning	XML Configuration File - Fatal Error - Configuration Aborted: <P1>; <P2>	P1=configuration file name P2=error description	F001.9	70000109	docslf3CmtsEventNotif
<b>CCAP ERM</b>							
CCAP-ERM		Critical	Session Loss type=<P1>; sessionId = <P2>;	P1 = session loss type P2 = sessionId	F002.1	70000201	docslf3CmtsEventNotif

<sup>241</sup> Modified per CCAP-OSSiv3.1-N-16.1499-1 on 5/16/16 by KB.

Process	Sub-Process	CCAP Priority	Event Message	Message Notes and Details	Error Code Set	Event ID	Trap Name
CCAP-ERMI		Critical	Link Down Loss of Service; Interface=<P1>;	for syslog & local-log Mandatory Add: ; Error Code = 0;  P1= MapPath	F002.2	70000202	docslf3CmtsEventNotif
CCAP-ERMI		Critical	Sessions Lost=<P1>; Sessions failed-over=<P2>	P1 = number of sessions lost P2 = number of failed-over sessions  for syslog & local-log Mandatory Add: ; Error Code = 0;	F002.3	70000203	docslf3CmtsEventNotif
CCAP-ERMI		Critical	Excessive network jitter in session, jitter buffer overflow; sessionID=<P1>	P1 = sessionID for syslog & local-log Mandatory Add: ; Error Code = 0;	F002.4	70000204	docslf3CmtsEventNotif
<b>CCAP Physical &amp; Environmental</b>							
CCAP- PE	Cooling	Critical	Cooling - Fan unit <P1> Failure; <P2>	P1 = entPhysicalIndex of fan unit P2 = entPhysicalName	F003.1	70000301	docslf3CmtsEventNotif
CCAP-PE	Cooling	Warning	Cooling - Sensor unit=<P1> - High Temperature Threshold Exceeded <P2>	P1 = entPhysicalIndex of temperature sensor P2 = Temp (F/C)	F003.2	70000302	docslf3CmtsEventNotif
CCAP-PE	Cooling	Warning	Cooling - Sensor unit=<P1> - Normal Operating Temperature Exceeded: <P2>	P1 = entPhysicalIndex of temperature sensor P2 = Temp (F/C)	F003.3	70000303	docslf3CmtsEventNotif
CCAP-PE	Power	Critical	Power - Power Supply unit-<P1> - Bus Failure	P1 = entPhysicalIndex of power supply unit	F003.4	70000304	docslf3CmtsEventNotif
CCAP-PE	Power	Warning	Power - Power supply unit=<P1>: <P2> - Below 95%	P1= entPhysicalIndex of power supply unit P2 = entPhysicalName of power supply unit	F003.5	70000305	docslf3CmtsEventNotif
CCAP-PE	Power	Notice	Power - Power Supply Switchover, Previous unit=<P1>: <P2>, New unit=<P2>: <P4>	P1 = entPhysicalIndex of power supply unit P2 = entPhysicalName of power supply unit P3 = entPhysicalIndex of power supply unit P4 = entPhysicalName of power supply unit	F003.6	70000306	docslf3CmtsEventNotif
CCAP-PE	Power	Critical	Power - Power Supply unit=<P1>: <P2> - Improper Input Voltage	P1 = entPhysicalIndex of power supply unit P2 = entPhysicalName of power supply unit	F003.7	70000307	docslf3CmtsEventNotif

Process	Sub-Process	CCAP Priority	Event Message	Message Notes and Details	Error Code Set	Event ID	Trap Name
CCAP-PE	Power	Critical	Power - Power Supply unit=<P1>: <P2> - Power Phase Disconnected	P1= entPhysicalIndex of power supply unit P2 = entPhysicalName of power supply unit e For Syslog and Local Log, append: CCAP shut down due to multiphase power problem	F003.8	70000308	docsIf3CmtsEventNotif
CCAP-PE	Power	Notice	Power - Power Supply unit=<P1>: <P2>; Operational	P1 = entPhysicalIndex of power supply unit P2 = entPhysicalName of power supply unit	F003.9	70000309	docsIf3CmtsEventNotif
CCAP-PE	Redundancy	Alert	Line Card Failure in slot=<P1> - No Redundancy	P1 = entPhysicalIndex of the slot number	F003.10	70000310	docsDevCmtsEventNotif
CCAP-PE	Redundancy	Critical	Line Card Failure in slot=<P1> failed over to redundant card in slot=<P2>	P1 = entPhysicalIndex of slot number of the failed line card P2 = entPhysicalIndex of slot number of the redundant line card	F003.11	70000311	docsDevCmtsEventNotif
CCAP-PE	Redundancy	Notice	Line Card Operational in slot=<P1>	<P1>=entPhysicalIndex of slot number	F003.12	70000312	docsDevCmtsEventNotif
CCAP-PE	Interface Status	Critical	Failover of interface ifIndex=<P1>, ifAlias=<P2> to interface ifIndex=<P3>, ifAlias<P4>	P1/P3 = ifIndex from ifTable for Ethernet Interface P2/P4 = ifAlias from ifTable for Ethernet Interface	F003.13	70000313	docsIf3CmtsEventNotif
CCAP-PE	Interface Status	Notice	Interface ifIndex=<P1>, ifAlias=<P2> Operational	P1 = ifIndex from ifTable for Ethernet Interface P2 = ifAlias from ifTable for Ethernet Interface	F003.14	70000314	docsIf3CmtsEventNotif
<b>CCAP COPS Interface</b>							
CCAP-COPS	Status	Critical	COPS Connection Limit Threshold Exceeded <TAGS>		F004.1	70000401	docsIf3CmtsEventNotif
<b>CCAP Content Protection</b>							
CCAP-CP	Encryptor	Alert	Stream not Restored; Manual intervention required: video traffic sessionId = <P1>	P1 = Video sessionId	F005.1	70000501	docsIf3CmtsEventNotif
<b>CCAP Denial of Service Protection</b>							
CCAP-DOS	Traffic	Error	Protocol throttling initiated: <P1>	P1 = Protocol being throttled	F006.1	70000601	docsIf3CmtsEventNotif

### D.1 Deprecated Events<sup>242</sup>

Table D-3 in this annex lists deprecated events, including any associated syslog and SNMP trap notifications for the events, for a DOCSIS 3.1-compliant CMTS/CCAP. Implementation of deprecated events is optional.

**Table D-3 - Deprecated Events<sup>243</sup>**

Process	Sub-Process	CMTS/CCAP Priority	Event Message	Message Notes and Detail	Error Code Set	Event ID	Notification Name
<b>Registration and TLV-11</b>							
Init	1.1 and 2.0 SPECIFIC REGISTRATION REQUEST	Warning	REG REQ rejected - Major PHS rule error<TAGS>		I201.12	73020112	docslf3CmtsEventNotif
<b>Dynamic Services</b>							
DYNAMIC SERVICES	DYNAMIC SERVICE REQUEST	Warning	Service Add rejected - PHS rule exists<TAGS>		S01.13	83000113	docslf3CmtsEventNotif
DYNAMIC SERVICES	DYNAMIC SERVICE REQUEST	Warning	Service Add rejected - PHS rule for another flow<TAGS>		S01.18	83000118	docslf3CmtsEventNotif
DYNAMIC SERVICES	DYNAMIC SERVICE REQUEST	Warning	Service Add rejected - Major PHS rule error<TAGS>		S01.23	83000123	docslf3CmtsEventNotif
DYNAMIC SERVICES	DYNAMIC SERVICE REQUEST	Warning	Service Change rejected - PHS rule not found<TAGS>		S02.12	83000212	docslf3CmtsEventNotif
DYNAMIC SERVICES	DYNAMIC SERVICE REQUEST	Warning	Service Change rejected - PHS rule exists<TAGS>		S02.13	83000213	docslf3CmtsEventNotif
DYNAMIC SERVICES	DYNAMIC SERVICE REQUEST	Warning	Service Change rejected - PHS rule for another flow<TAGS>		S02.18	83000218	docslf3CmtsEventNotif
DYNAMIC SERVICES	DYNAMIC SERVICE REQUEST	Warning	Service Change rejected - Major PHS error<TAGS>		S02.23	83000223	docslf3CmtsEventNotif
DYNAMIC SERVICES	DYNAMIC SERVICE RESPONSE	Warning	Service Add Response rejected - PHS rule exists<TAGS>		S101.10	83010110	docslf3CmtsEventNotif

<sup>242</sup> Added per CCAP-OSSv3.1-16.1533-2 on 11/15/16 by KB.

<sup>243</sup> Modified per CCAP-OSSv3.1-N-16.1609-1 on 11/17/16 b KB.



Process	Sub-Process	CMTS/ CCAP Priority	Event Message	Message Notes and Detail	Error Code Set	Event ID	Notification Name
DYNAMIC SERVICES	DYNAMIC SERVICE RESPONSE	Warning	Service Add Response rejected - Major PHS Rule error<TAGS>		S101.16	83010116	docsIf3CmtsEventNotif
DYNAMIC SERVICES	DYNAMIC SERVICE RESPONSE	Warning	Service Change Response rejected - Major PHS rule error<TAGS>		S102.13	83010213	docsIf3CmtsEventNotif
DYNAMIC SERVICES	DYNAMIC SERVICE RESPONSE	Warning	Service Change Response rejected - PHS rule exists<TAGS>		S102.9	83010209	docsIf3CmtsEventNotif
<b>UCC</b>							
UCC	UCC Response	Warning	UCC-RSP not received on previous channel ID<TAGS>		C101.0	67010100	
UCC	UCC Response	Warning	UCC-RSP received with invalid channel ID<TAGS>		C102.0	67010200	
UCC	UCC Response	Warning	UCC-RSP received with invalid channel ID on new channel<TAGS>		C103.0	67010300	

## D.2 Example SNMP Notification and Syslog Event Message

The following is an example SNMP Notification and Syslog message "Event Message" text string for Event ID 70000304:

```
Power - Power Supply Bus Failure; unit=pw/1/1/;
```

## Annex E Extending the Configuration Data Model (Normative)

While the majority of the CCAP configuration data model is standardized in the XML schema and YANG module, it is anticipated that vendors will extend the configuration data model to support vendor-proprietary functionality. This appendix summarizes the guidelines that should be followed when extending the configuration data model and provides examples of how the configuration data model can be extended in YANG and in XML.

### E.1 XML Schema Extension

Vendor-specific extensions to the CCAP XML schema are only allowed within the provided "<ext>" elements in the CCAP schema. Those extensions are proprietary to the vendor. The proprietary content is not defined within this specification.

Vendor-proprietary schemas intended to extend the standard XML schema are required to use a vendor-specific, globally-unique URI for the XML namespace for that vendor. Namespace URIs need to be chosen such that they cannot collide with standard or other enterprise namespaces; for example, the enterprise or organization name could be used in the namespace.

The CCAP XML schema provides a complex type that allows vendors to add a standardized version number to their vendor-specific extension. This complex data type is shown in Appendix III, Vendor Schema Version in the CCAP XSD. While it is not mandatory for a vendor-specific extension to include a vendor version number, if a vendor version number is included, this complex type is required to be used to convey the version information. This version number is in addition to the CCAP XSD version information.

In addition to extension of the XML schema via complementary vendor-proprietary elements inserted within <ext> elements of the standard schema, a mechanism has been defined whereby vendors can extend their configuration model in YANG, but convert these extensions to XML schema. Refer to Annex E.2 for details. In this case, a single XML configuration file will validate against both the vendor-proprietary XML schema and the standard schema.

The CCAP MUST reject any XML configuration that would not validate against the standard XML schema.

#### E.1.1 Sample Vendor-Specific XSD Extensions

##### E.1.1.1 Extending a Standard Configuration Object

The following example adds attributes to the rf-line-card element in the XSD using both a simple type and a new, named complex type. This example vendor XSD file is referenced within configurations that include these new elements.

```
<xs:schema xmlns:xs="http://www.w3.org/2001/XMLSchema"
xmlns="urn:cablelabs:params:xml:ns:yang:vendor" xmlns:vendor="vendor"
xmlns:ccap="urn:cablelabs:params:xml:ns:yang:ccap" targetNamespace="vendor"
attributeFormDefault="unqualified" version="0001:000A" xml:lang="en">
  <xs:import namespace="urn:cablelabs:params:xml:ns:yang:ccap"
schemaLocation="ccap@2013-04-04.xsd"/>
  <xs:element name="ds-annex" type="ccap:downstream-phy-type">
    <xs:annotation>
      <xs:documentation>Annex for entire DS RF card</xs:documentation>
    </xs:annotation>
  </xs:element>
  <xs:element name="rf-linecard-details" type="vendor:Rf-Card-Model">
    <xs:annotation>
      <xs:documentation>Type of line-card</xs:documentation>
    </xs:annotation>
  </xs:element>
  <xs:complexType name="Rf-Card-Model">
    <xs:sequence>
      <xs:element name="model" minOccurs="1">
        <xs:annotation>
          <xs:documentation>Model number of linecard</xs:documentation>
        </xs:annotation>
        <xs:simpleType>
          <xs:restriction base="xs:string">
            <xs:enumeration value="U1"/>
            <xs:enumeration value="D1"/>
          </xs:restriction>
        </xs:simpleType>
      </xs:element>
    </xs:sequence>
  </xs:complexType>
</xs:schema>
```

```

        <xs:enumeration value="D2" />
      </xs:restriction>
    </xs:simpleType>
  </xs:element>
  <xs:element name="num-rf-ports" type="xs:unsignedByte" minOccurs="1">
    <xs:annotation>
      <xs:documentation>Maximum number of RF ports on the card</xs:documentation>
    </xs:annotation>
  </xs:element>
</xs:sequence>
</xs:complexType>
</xs:schema>

```

### E.1.1.1.1 Sample Configuration File Using Extended Standard Configuration Objects

In the following example, the vendor-proprietary XSD from the previous section is used to validate the following XML configuration file.

```

<ccap:ccap xmlns:xsi="http://www.w3.org/2001/XMLSchema-instance" SchemaVersion="2013-04-04"
xsi:schemaLocation="urn:cablelabs:params:xml:ns:yang:ccap ccap@2013-04-04.xsd"
xmlns:ccap="urn:cablelabs:params:xml:ns:yang:ccap" operation="merge">
  <chassis>
    <slot>
      <slot-number>1</slot-number>
      <rf-line-card>
        <rf-card>
          <line-card-name>Downstream RF Line Card 1</line-card-name>
          <admin-state>up</admin-state>
          <protected-by>2</protected-by>
        </rf-card>
        <encryptor>
          <encryptor-index>1</encryptor-index>
          <ca-encryptor-type>motorola</ca-encryptor-type>
          <ecm-timeout>10</ecm-timeout>
          <clear-stream-timeout>10</clear-stream-timeout>
          <ecmg-usage>
            <ecmg-usage-index>1</ecmg-usage-index>
            <priority>1</priority>
            <ecmg-ref>1</ecmg-ref>
          </ecmg-usage>
        </encryptor>
      <ext>
        <vendor:ds-annex xsi:schemaLocation="vendor vendor.xsd" xmlns:vendor="vendor"
xmlns:xsi="http://www.w3.org/2001/XMLSchema-instance">j83annexB</vendor:ds-annex>
        <vendor:rf-linecard-details xmlns:vendor="vendor"
xmlns:xsi="http://www.w3.org/2001/XMLSchema-instance">
          <model>D2</model>
          <num-rf-ports>12</num-rf-ports>
        </vendor:rf-linecard-details>
      </ext>
    </rf-line-card>
  </slot>
</chassis>
</ccap:ccap>

```

### E.1.1.2 Extending by Adding a New Object Type

The following example defines an XSD schema for a new vendor-specific configuration object, realizing the CLI command "crypto pki token default removal timeout [*seconds*]".

```

<xs:schema xmlns:xs="http://www.w3.org/2001/XMLSchema" xmlns="http://www.vendor2.com/example-ns-
partial-crypto-ccap" xmlns:ccap="urn:cablelabs:params:xml:ns:yang:ccap" xmlns:ns1="vendor2"
targetNamespace="vendor2" elementFormDefault="qualified" attributeFormDefault="unqualified"
version="2010-11-8" xml:lang="en">
  <xs:import namespace="urn:cablelabs:params:xml:ns:yang:ccap" schemaLocation="ccap@2013-04-
04.xsd" />
  <xs:annotation>
    <xs:documentation xml:lang="en">
      An example of a schema defining the crypto CLI command.
    </xs:documentation>

```

```

</xs:annotation>
<xs:element name="crypto">
  <xs:complexType>
    <xs:sequence>
      <xs:element name="pki">
        <xs:complexType>
          <xs:sequence>
            <xs:element name="token">
              <xs:complexType>
                <xs:sequence>
                  <xs:element name="default">
                    <xs:complexType>
                      <xs:sequence>
                        <xs:element name="removal">
                          <xs:complexType>
                            <xs:sequence>
                              <xs:element name="timeout">
                                <xs:complexType>
                                  <xs:sequence>
                                    <xs:element name="TokenKeyTimeoutSeconds" type="xs:unsignedInt"/>
                                  </xs:sequence>
                                </xs:complexType>
                              </xs:element>
                            </xs:sequence>
                          </xs:complexType>
                        </xs:element>
                      </xs:sequence>
                    </xs:complexType>
                  </xs:element>
                </xs:sequence>
              </xs:complexType>
            </xs:element>
          </xs:sequence>
        </xs:complexType>
      </xs:element>
    </xs:sequence>
  </xs:complexType>
</xs:element>
</xs:schema>

```

#### E.1.1.2.1 Sample Configuration File Using the New Vendor Extension Objects

In the following example, the vendor-proprietary XSD from the previous section is used to validate the following XML configuration file.

```

<ccap:ccap xmlns:xsi="http://www.w3.org/2001/XMLSchema-instance" SchemaVersion="2013-04-04"
xmlns:ccap="urn:cablelabs:params:xml:ns:yang:ccap" operation="merge" xsi:schemaLocation="vendor2
CCAP-vendor-extension-example-2.xsd">
  <ext>
    <vendor-extension-version xmlns:xsi="http://www.w3.org/2001/XMLSchema-instance">
      <major-version>1</major-version>
      <minor-version>0</minor-version>
    </vendor-extension-version>
    <crypto xsi:schemaLocation="vendor2 CCAP-vendor-extension-example-2.xsd"
xmlns="http://www.vendor2.com/example-ns-partial-crypto-ccap">
      <pki>
        <token>
          <default>
            <removal>
              <timeout>
                <TokenKeyTimeoutSeconds>11</TokenKeyTimeoutSeconds>
              </timeout>
            </removal>
          </default>
        </token>
      </pki>
    </crypto>
  </ext>
</ccap:ccap>

```

**NOTE:** The above example of vendor extension schema has been developed using design principles diverging from the object oriented methodology utilized throughout this specification. The goal of such an example is to demonstrate the flexibility in defining vendors extensions. The example should not be considered a methodology or a style recommendation.

## E.2 YANG Configuration Model Extension

Any extensions to the YANG configuration data model are required to adhere to the requirements in Section 6.6.2, Vendor-Specific Extensions.

### E.2.1 YANG Extension Principles

Extensions to the YANG configuration data structure are required to be defined in a separate module, rather than within one of the standard CCAP module files. Doing so leaves the standard configuration object model intact and helps to ensure interoperability.

Vendor-proprietary sub-node extensions to standard "list", "choice", and "container" elements are permitted via the use of the "augment" syntax within the vendor-proprietary YANG module. These extensions are only allowed to the "yang-ext" container (which is included in elements eligible for extension). This requirement is to ensure that when the vendor-proprietary YANG module (which imports the standard module) is converted to XML schema, that instance documents valid against the resulting schema are also valid against the standard schema.

In general, vendor-proprietary extensions to the standard YANG module should not use "deviation" statements to alter standard configuration objects. As the fundamental requirement is that nothing be done via YANG extension that would cause configurations valid against the vendor's XML schema to be invalid against the standard schema, deviations are only viable when they place tighter restrictions on an element than the standard schema does.

Vendor-proprietary extensions to the standard YANG modules are required to use a vendor-specific, globally-unique URI for the XML namespace for that vendor. Namespace URIs are chosen so that they cannot collide with standard or other enterprise namespaces; for example the enterprise or organization name could be used in the namespace.

### E.2.2 Creating Vendor Extensions

This section provides a few illustrative examples of creating vendor extensions in YANG. Refer to [RFC 6020] for a complete reference to the extension mechanisms of the YANG language.

#### E.2.2.1 Specifying the Vendor-Proprietary Namespace in YANG

When creating a vendor-specific YANG extension file, the vendor's namespace is required. Vendors that intend to extend the standard YANG module will use a unique URI to define the XML namespace. The following example depicts this concept.

```
module example-ccap-extension {
  yang-version 1;
  namespace "http://www.example.com/ccap-extension";
  prefix "vendor-ext";
  import ccap { prefix "ccap"; revision-date "2012-04-01"; }
  organization "EXAMPLE VENDOR";
  contact
    "WG-email: example@vendor.com";
  description
    "Vendor Specific";
  revision "2012-04-01" {
    description "Initial version ";
  }

  container ccap {
    uses ccap:ccap-group;
  }
} // vendor-module
```

### E.2.2.2 Extending a Container or List in YANG

To extend standard configuration objects with vendor-proprietary objects, the "augment" syntax is used to define the location where new nodes are inserted into the standard YANG module, as well as to define the new nodes to be inserted. An "augment" statement always adds a new node to the configuration model and is only allowed, per this specification, in the "yang-ext" elements that are provided in the standard YANG module precisely for this purpose.

Note that using the "deviation" syntax to extend the YANG configuration data model is only allowed in the cases outlined below.

The following tables summarize the acceptable ways to extend CCAP configuration data model objects.

**Table E-1 - Extending CCAP Configuration Objects with the "augment" Statement**

Object	Extension Use Case	Method to Extend
Container	Add new data node (leaf, list, etc.) to container	Augment the container with new data node. The following example adds a new leaf to the chassis container. <pre>augment "/ccap:ccap/ccap:chassis/yang-ext" {   leaf contact-name {     type string;     description "Contact name";   } }</pre>
List	Add new data node (leaf, list, etc.) to list	Augment a list with new data node. The following example adds a new leaf to the ds-rf-port - group object. <pre>augment "/ccap:ccap/ccap:chassis/ccap:slot/ccap:line-card- type/ccap:rf-line-card/ccap:rf-line-card/ccap:ds-rf-port/yang-ext" {   leaf super-spectrum {     type boolean;     mandatory false;     description "Turns on or off the super spectrum feature.";   } }</pre>
Choice	Add a new case to an existing choice object	Augment a choice with a new case data definition. The following example adds a new line card type to the line-card choice node. <pre>augment "/ccap:ccap/ccap:chassis/ ccap:slot/ccap:line-card-type/yang-ext/yang-choice-ext" {   case vendor-new-line-card {     list rf-port {       key "port-number";       uses ccap:port-group;     }   } }</pre>
type	Change the range attribute associated with a typedef	The range specified for an existing typedef can be altered when included in a new leaf, as long as the new range specified is more narrow than the default range. The following example sets a smaller range for the InetPortNumber typedef when used in the new port-number leaf. <pre>augment "/ccap:ccap/ccap:chassis/ccap:slot/ccap:line-card-type/ ccap:rf-line-card/ccap:rf-line-card/yang-ext" {   leaf admin-port-number {     type inet:port-number {       range "1..45";     }   } }</pre>

**Table E-2 - Extending CCAP Configuration Objects with the "deviation" Statement**

Extension Use Case	Method to Extend
Add a range where one did not exist or replace an existing range	<pre>deviation "/ccap:ccap/ccap:chassis/ccap:slot/ccap:slot-number" {   deviate replace {     type int8 {       range "0..13";     }   } }</pre>
Put a bound on the total number of items supported, where no max-elements existed	<pre>deviation "/ccap:ccap/ccap:docsis/ccap:docs-mac-domain/ccap:mac-domain " {   deviate add {     max-elements 100;   } }</pre>
Replace the bound on the total number of items supported, where a max-elements definition existed	<pre>deviation "/ccap:ccap/ccap:docsis/ccap: docs-mac-domain/ccap:mac-domain" {   deviate replace {     max-elements 100;   } }</pre>
Remove a default value and make the item mandatory	<pre>// First remove the default deviation "/ccap:ccap/ccap:docsis/ccap:docs-mac-domain/ccap:mac-domain/ccap:mdd-interval" {   deviate delete {     default "2000";   } } //Now add the mandatory true property deviation "/ccap:ccap/ccap:docsis/ccap:docs-mac-domain/ccap:mac-domain/ccap:mdd-interval" {   deviate add {     mandatory "true";   } }</pre>

### E.2.3 Example Vendor-Proprietary Extensions in YANG Configuration Messages

The following examples show a vendor-extension YANG module and a partial CCAP configuration that uses those vendor extensions.

#### E.2.3.1 Sample Vendor-Extension YANG Module

In this example, the following elements are extended:

- A contact-name leaf is added to the chassis container
- The InetPortNumber typedef has its range narrowed in the port-number leaf
- A new case is added to the card-type choice definition

```
module example-ccap-extension {
  yang-version 1;
  namespace "http://www.example.com/ccap-extension";
  prefix "ccap-extension";
  import ccap { prefix "ccap"; }
  organization
    "Example Vendor";
  contact
    "WG-email: example@vendor.com";
  description
    "Vendor Specific";
  revision "2013-04-04" {
    description "Initial version ";
  }
  augment "/ccap/chassis/slot/line-card-type/rf-line-card/yang-ext1" {
    leaf admin-port-number {
      type inet:port-number {
```



```

        range "1..45";
    }
}
}
augment "/ccap/chassis/slot/line-card-type/yang-choice-ext" {
    choice vendor-line-card {
        case vendor-turbo-card {
            list rf-port {
                key "port-number";
                uses ccap:port-group;
            }
        }
    }
}
augment "/ccap/chassis/yang-ext" {
    leaf contact-name {
        type string;
        description "Contact name";
    }
}
}

```

### E.2.3.2 Sample Partial Configuration Message Using Vendor Extensions

```

<ccap:ccap nc:operation="merge" xmlns:xsi="http://www.w3.org/2001/XMLSchema-instance"
  SchemaVersion="2013-04-04"
  xsi:schemaLocation="urn:arris:ns:yang:1.0:vendor ccap-vendor-yang-ext.xsd"
  xmlns:ccap="urn:arris:ns:yang:1.0:vendor">
<chassis>
  <slot>
    <slot-number>3</slot-number>
    <yang-choice-ext>
      <vendor-turbo-card>
        <rf-port>
          <port-number>6</port-number>
        </rf-port>
      </vendor-turbo-card>
    </yang-choice-ext>
  </slot>
  <slot>
    <slot-number>4</slot-number>
    <rf-line-card>
      <yang-ext1>
        <admin-port-number>27</admin-port-number>
      </yang-ext1>
    </rf-line-card>
  </slot>
  <yang-ext>
    <contact-name>customer support</contact-name>
  </yang-ext>
</chassis>
</ccap>

```

## Annex F CCAP Data Type Definitions (Normative)

### F.1 Overview

This annex includes the data type definitions for the Information Models defined for use in the CCAP. The Unified Modeling Language (UML) is used for modeling the management requirements. The data types defined in this annex are mapped for use with YANG data types.

The data types defined in this Annex are mapped for use with SNMP MIBs, IPDR XML schemas, YANG modules and XSD Schemas.

Basic UML notation used in this specification is explained in Appendix VII.

### F.2 Data Types Mapping

XML is becoming the standard for data definition models. With XML data transformations can be done with or without a model (DTD or Schema definition). DTDs and XML schemas provides additional data validation layer to the applications exchanging XML data. There are several models to map formal notation constructs like ASN.1 to XML [ITU-T X.692], UML to XML, YANG to XML, or XML by itself can be used for modeling purposes.

Each area of data information interest approaches XML and defines data models and/or data containment structures and data types. Similarly, SNMP took and modified a subset of ASN.1 for defining the Structured Management Information SMIv1 and SMIv2.

Due to the lack of a unified data model and data types for Network Management a neutral model would be appropriated to allow capturing specific requirements and methodologies from existing protocols and allow forward or reverse engineering of those standards like SNMP to the general object model and vice versa.

### F.3 Data Types Requirements and Classification

The Information Model has to provide seamless translation for SMIv2 requirements, in particular when creating MIB modules based on the Information Model, this specification needs to provide full support of [RFC 2578], [RFC 2579], and the clarifications and recommendations of [RFC 4181].

The Information Model has to provide seamless translation for IPDR modeling requirements which is by itself a subset of XML representations with some IPDR extensions.

The Information Model has to provide seamless translation for YANG modeling requirements, in particular when creating YANG modules based on the Information Model.

Thus, there are two data type groups defined for modeling purposes and mapping to protocol data notation roundtrip.

- General data types

Required data types to cover all the management syntax and semantic requirement for all OSSI supported data models. In this category are data types defined in SNMP SMIv2 [RFC 2578], IPDR data types [IPDR/XDR] and [IPDR/SSDG], and YANG common data types [RFC 6991].

- Extended data types

Management protocols specialization based on frequent usage or special semantics. Required data types to cover all the syntax requirement for all OSSI supported data models. In this category are SNMP TEXTUAL-CONVENTION clauses [RFC 2579] of mandatory or recommended usage by [RFC 2579] and [RFC 4181] when modeling for SNMP MIB modules.

### F.4 Data Type Mapping Methodology

The specification "XML Schema Part 2: Data types Second Edition" is based on [ISO 11404] which provides a language-independent data types (see XML Schema reference). The mapping proposed below uses a subset of the XML schema data types to cover both SNMP forward and reverse engineering and as well IPDR types. Any additional protocol being added should be feasible to provide the particular mappings.

SMIv2 has an extensive experience of data types for management purposes, for illustration consider Counter32 and Counter64 SMIv2 types [RFC 2578]. The XML schema data types makes no distinction of derived 'decimal' types and the semantics that are associated to counters, e.g., counters do not necessarily start at 0.

Most of the SNMP information associated to data types are reduced to size and range constraints and specialized enumerations.

## F.5 General Data Types (SNMP and IPDR Mapping)

The Table F-1 represents the mapping between the OSSI object model General Types and their equivalent representation for SNMP MIB Modules and IPDR Service Definitions. The permitted values for the data types are indicated in terms of value ranges and string length when applicable. The OM Data Type column includes the data types to map either to IPDR or SNMP or both, using the appropriated type in the corresponding protocol if applicable or available. The SNMP Mapping references to SNMP data types are defined in [RFC 2578] or as described below. The IPDR Mappings are referenced in [IPDR/XDR] and [IPDR/SSDG], or as specified below.

Note that SNMP does not provide float, double or long XML-Schema data types. Also, SNMP might map a type to a SNMP subtyped value. For example, unsignedByte data type maps to Unsigned32 subtyped to the appropriate range indicated by the Permitted Values (0..255 in this case). Other data types are mapped to SNMP TEXTUAL-CONVENTIONS as indicated by the references.

**Table F-1 - General Data Types**

OM Data Type	XML-Schema data type	Permitted Values	SNMP Mapping	IPDR Mapping
Enum	int	-2147483648..2147483647	INTEGER	integer
EnumBits	hexBinary		BITS	hexBinary
Int	int	-2147483648..2147483647	Integer32	int
unsignedInt	unsignedInt	0..4294967295	Unsigned32	unsignedInt
long	long	-9223372036854775808..-9223372036854775807	N/A	long
unsignedLong	unsignedLong	0..18446744073709551615	CounterBasedGauge64 [RFC 2856]	unsignedLong
hexBinary	hexBinary		OCTET STRING	hexBinary
string	string		SmpAdminString [RFC 3411]	string
boolean	boolean		TruthValue [RFC 2579]	boolean
Byte	byte	-128..127	Integer32	byte
unsignedByte	unsignedByte	0..255	Unsigned32	unsignedByte
Short	short	-32768..32767	Integer32	short
unsignedShort	unsignedShort	0..65535	Unsigned32	unsignedShort
Gauge32,	unsignedInt		Gauge32	
Counter32,	unsignedInt		Counter32	
Counter64	unsignedLong		Counter64	
IpAddress	hexBinary	SIZE (4)	IpAddress	
Opaque	hexBinary		Opaque	
dateTime	dateTime		DateAndTime	dateTime
dateTimeMsec	unsignedLong		CounterBasedGauge64 [RFC 2856]	ipdr:dateTimeMsec
InetAddressIPv4	hexBinary	SIZE (4)	InetAddressIPv4 [RFC 4001]	ipdr:ipV4Addr
InetAddressIPv6	hexBinary	SIZE (16)	InetAddressIPv6 [RFC 4001]	ipdr:ipV6Addr
InetAddress			InetAddress [RFC 4001]	N/A
InetAddressType			InetAddressType [RFC 4001]	N/A
Uuid	hexBinary		OCTET STRING	ipdr:uuid

OM Data Type	XML- Schema data type	Permitted Values	SNMP Mapping	IPDR Mapping
MacAddress	hexBinary	SIZE (6)	MacAddress	ipdr:macAddress

### F.6 Primitive Data Types (YANG Mapping)

The Table F-2 represents the mapping between the CCAP primitive data types and their equivalent representation in YANG. The permitted values for the data types are indicated in terms of value ranges and string length when applicable. The UML Primitive Data Type column includes the data types to map to YANG, using the appropriated type in YANG. The YANG Built-In Data Type Mapping references YANG data types defined in [RFC 6021] or as described below.

**Table F-2 - Primitive Data Types**

UML Primitive Data Type	YANG Data Type Mapping	Permitted Values
HexBinary	ccap-octet-data-type	([0-9a-fA-F]{2})*
EnumBits	bits	
Boolean	boolean	true, false
Enum	enumeration	-2147483648..2147483647
Byte	int8	-128..127
Short	int16	-32768..32767
Integer	int32	-2147483648..2147483647
Long	int64	-9223372036854775808..9223372036854775807
String	string	
UnsignedByte	uint8	0..255
UnsignedShort	uint16	0..65535
UnsignedInt	uint32	0..4294967295
UnsignedLong	uint64	0..18446744073709551615

### F.7 Extended Data Types (SNMP and IPDR Mapping)

There are two sources of Extended Data Types: Protocol specific data types, and OSSI data types.

The subset of IPDR derived DataTypes [IPDR/SSDG] and [IPDR/XDR] are included in the General Data Types section as they are few. SNMP derived types are defined in SNMP MIB Modules. The most important are in [RFC 2579] which is part of SNMP STD 58 and are considered in many aspects part of the SNMP protocol. Other MIB modules TEXTUAL-CONVENTION definitions have been adopted and recommended (e.g., [RFC 4181]) for re-usability and semantics considerations in order to unify management concepts; some relevant RFCs that include common used textual conventions are [RFC 4001], [RFC 2863], [RFC 3411], and [RFC 3419] among others (see [RFC 4181]).

Table F-2 includes the most relevant data types taken from SNMP to provide a direct mapping of the OSSI object model to SNMP MIB modules. A few have taken a more general name as they are used across the object models and may apply to IPDR high level modeling as well. For example, TagList comes from [RFC 3413] SnmpTaglist and preserves its semantics, AdminString comes from [RFC 3411] SnmpAdminString.

In general when an OSSI object model needs to reference an existing SNMP textual convention for the purpose of round trip design from UML to SNMP, these textual conventions can be added to this list. Other sources of textual conventions not listed here are from MIB modules specific to DOCSIS either as RFCs or Annex documents in this specification. Some of those are [RFC 4546] and Annex A.

OSSI data types are also defined in this specification in the Data Type section of various sections; for example, in Annex A and in Section 7.

**Table F-3 - Extended Data Types**

OM Data Type	XML- Schema data type	Permitted Values	SNMP Mapping	IPDR Mapping
PhysicalIndexOrZero	unsignedInt	0..2147483647	Integer32	unsignedInt
TagList	string	SIZE (0..255)	SnmpTaglist	string
AdminString	string	SIZE (0..255)	SnmpAdminString	string
RowStatus	int		RowStatus	int
TimeStamp	unsignedInt		TimeStamp	unsignedInt
duration	unsignedInt	0..2147483647	TimeInterval	unsignedInt
StorageType	int		StorageType	int
InetAddressPrefixLength	unsignedInt	0..2040	Unsigned32	unsignedInt
InetPortNumber	unsignedInt	0..65535	Unsigned32	unsignedInt
DocsisQosVersion	int		DocsisQosVersion [RFC 4546]	int
DocsisUpstreamType	int		DocsisUpstreamType [RFC 4546]	int
DocsEqualizerData	hexBinary		DocsEqualizerData [RFC 4546]	hexBinary
TenthdBmV	int		TenthdBmV [RFC 4546]	int
TenthdB	int		TenthdB [RFC 4546]	int

## F.8 Derived Data Types (YANG Mapping)

Table F-4 represents the mapping between the CCAP derived data types and their equivalent representation in YANG. The permitted values for the data types are indicated in terms of value ranges and string length when applicable. The UML Derived Data Type column includes the data types to map to YANG, using the appropriated type in YANG. The YANG Derived Data Type Mapping references YANG data types defined in [RFC 6021] or as described below.

**Table F-4 - Derived Data Types**

UML Derived Data Type	YANG Derived Data Type Mapping	Permitted Values
Counter32	counter32	
Counter64	counter64	
Gauge32	gauge32	
TimeStamp	timestamp	
MacAddress	mac-address	e.g., 01:23:45:67:89:ab
InetPortNumber	port-number	0..65535
IPAddress	ip-address	IPv4 or IPv6 Address
IPv4Address	ipv4-address	IPv4 Address
IPv6Address	ipv6-address	IPv6 Address
InetAddressPrefixLength	address-prefix-len-type	0..2040
InetIpv4Prefix	ipv4-prefix	IPv4 Address "/" IPv4 Prefix Length
InetIpv6Prefix	ipv6-prefix	IPv6 Address "/" IPv6 Prefix Length
Uri	uri	
TagList	snmp-tag-list-type	String(SIZE(0..255))
AdminState	admin-state-type	other(1), up(2), down(3), testing(4)
DateTime	date-and-time	

## Annex G Diagnostic Log (Normative)<sup>244</sup>

### G.1 Overview

The Diagnostic Log allows operators to diagnose and troubleshoot potential problems with CCAP/CMTS cable interfaces, Cable Modems (CMs), or the cable plant by detecting and tracking CMs that have intermittent connectivity problems or unstable operations including:

- CM repeated registration
- Station Maintenance retry

Only detected CMs are reported in the Diagnostic Log for further analysis. Diagnostic Log entries are aged out based on the configuration of the specific aging attributes.

### G.2 Object Definitions

This section describes the object definitions for the Diagnostic Log object model.

The DOCSIS Diagnostic Log object model is depicted in Figure G-1. This diagram graphically presents the individual DOCSIS Diagnostic Log objects and their attributes. The DOCSIS Diagnostic Log MIB and the DOCSIS Diagnostic Log IPDR Service Definition schema are derived from the object model.

---

<sup>244</sup> Annex added per CCAP-OSSv3.1-N-14.1225-1 on 1/8/15 by KB.

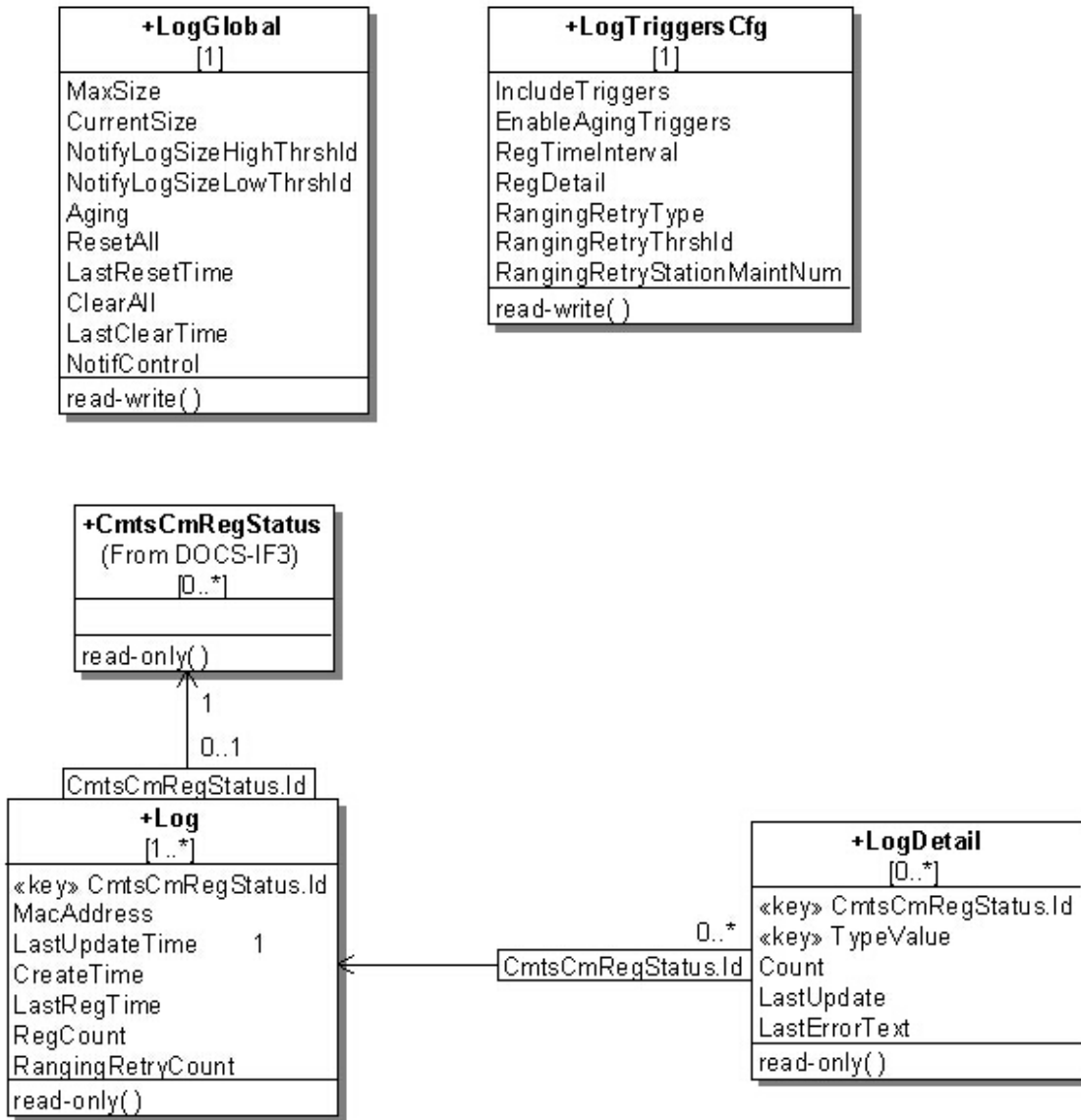

Figure G-1 - Diagnostic Log Object Model Diagram

**G.2.1 Type Definitions**

This section defines data types used in the object definitions for the Diagnostic Log object model.

**Table G-1 - Data Type Definitions**

Data Type Name	Base Type	Permitted Values
TriggerFlag	EnumBits	registration(0) rangingRetry(1)
RegistrationDetailFlag	EnumBits	other(0) initialRanging(1) rangingAutoAdjComplete(2) startEae(3) startDhcpv4(4) startDhcpv6(5) dhcpv4Complete(6) dhcpv6Complete(7) startConfigFileDownload(8) configFileDownloadComplete(9) startRegistration(10) registrationComplete(11) bpilnit(12) operational(13)

**G.2.1.1 TriggerFlag**

This data type defines the union of Diagnostic Log trigger types. Bit 0 represents the registration trigger, Bit 1 represents the ranging retry trigger.

**G.2.1.2 RegistrationDetailFlag**

This data type defines an enumerated union of CM states used for the registration trigger detection.

The named bits associated with this type correspond to a subset of the names for the enumerations in CmtsCmRegState data type.

**G.2.2 LogGlobal Object**

This object defines the parameters to manage and control the instantiation of CMs in the Diagnostic Log object.

The CMTS MUST persist the values of the attributes of the LogGlobal object across reinitializations.

**Table G-2 - LogGlobal Object**

Attribute Name	Type	Access	Type Constraints	Units	Default
MaxSize	unsignedInt	read-write	1..4294967295	instances	100
CurrentSize	Gauge32	read-only	0..4294967295	instances	N/A
NotifyLogSizeHighThrshld	unsignedInt	read-write	1..4294967295	instances	80
NotifyLogSizeLowThrshld	unsignedInt	read-write	1..4294967295	instances	60
Aging	unsignedInt	read-write	15..86400	minutes	10080
ResetAll	boolean	read-write		N/A	N/A
LastResetTime	dateTime	read-only		N/A	N/A
ClearAll	boolean	read-write		N/A	N/A
LastClearTime	dateTime	read-only		N/A	N/A
NotifCtrl	EnumBits	read-write	highThresholdReached(0) lowThresholdReached(1) full(2)	N/A	"H"

**G.2.2.1 MaxSize**

This attribute indicates the maximum number of CM instances that can be reported in the Log.



**G.2.2.2 CurrentSize**

This attribute indicates the number of CM instances currently reported in the Log. It will not exceed MaxSize.

**G.2.2.3 NotifyLogSizeHighThrshld**

This attribute is the Log high threshold value. When the number of instances in the Log exceeds this value, the CMTS will trigger a HighThreshold event.

**G.2.2.4 NotifyLogSizeLowThrshld**

This attribute is the Log low threshold value. When the number of instances in Log drops to this value, the CMTS will trigger a LowThreshold event, but only if the Log number of instances previously exceeded the NotifyLogSizeHighThrshld value.

**G.2.2.5 Aging**

This attribute defines a period of time after which an instance in the Log and its corresponding LogDetail instance (if present) are removed unless the Log instance is updated by an enabled trigger detection process.

**G.2.2.6 ResetAll**

This attribute, when set to 'true', causes all counter attributes for all instances in Log and LogDetail to be reset to zero. When read, this attribute always returns 'false'.

**G.2.2.7 LastResetTime**

This attribute returns the date and time that all the counters in the Log, LogDetail and all the trigger- related objects were reset to 0 due to the ResetAll attribute being set to 'true'. The special value of all '00'Hs indicates that the entries in the Log have never been reset.

**G.2.2.8 ClearAll**

This attribute, when set to 'true', removes all instances from the Log and LogDetail. When read, this attribute always returns 'false'.

**G.2.2.9 LastClearTime**

This attribute returns the date and time that all the instances in the Log and LogDetail, and all trigger-related objects were removed due to the ClearAll attribute being set to 'true'. The special value of all '00'Hs indicates that the entries in the Log have never been destroyed.

**G.2.2.10 NotifCtrl**

This attribute is used to enable diagnostic log related notifications. Setting bit 0 enables notification for reaching log size high threshold. Setting bit 1 enables notification for returning back to log size low threshold after reaching log size high threshold. Setting bit 2 enables notification for Diagnostic Log size full.

**G.2.3 LogTriggersCfg Object**

This object defines the parameters to configure the Diagnostic Log triggers. One or more triggers can be configured to define the actions of creating or updating CM entries into the Diagnostic Log.

The CMTS MUST persist the values of the attributes of the LogTriggersCfg object across reinitializations.

**Table G-3 - LogTriggersCfg Object**

Attribute Name	Type	Access	Type Constraints	Units	Default
IncludeTriggers	TriggerFlag	read-write		N/A	'C0'H
EnableAgingTriggers	TriggerFlag	read-write		N/A	"H
RegTimeInterval	unsignedInt	read-write	60..86400	seconds	90
RegDetail	RegistrationDetailFlag	read-write		N/A	"H
RangingRetryType	Enum	read-write	consecutiveMiss(1) missRatio(2)	N/A	1

Attribute Name	Type	Access	Type Constraints	Units	Default
RangingRetryThrshld	unsignedByte	read-write	3..12	N/A	6
RangingRetryStationMaintNum	unsignedShort	read-write	60..65535	N/A	90

### **G.2.3.1** *IncludeTriggers*

This attribute turns individual diagnostic triggers on and off at a given time when each trigger is set to '1' or '0', respectively.

### **G.2.3.2** *EnableAgingTriggers*

This attribute enables and disables the aging of individual triggers at a given time when each trigger is set to '1' or '0', respectively. If a log entry is added by multiple triggers, and aging is disabled for one of those triggers, the CMTS MUST NOT age out such entry.

### **G.2.3.3** *RegTimeInterval*

This attribute is an operator empirically derived, worst-case number of seconds which the CM requires to complete registration. If the CM has not completed the registration stage within this registration time interval, the CM will be added to the Diagnostic Log.

### **G.2.3.4** *RegDetail*

This attribute provides for setting a bit representing a CM registration state to enable counting the number of times the CMTS determines that such CM reaches that state as the last state before failing to proceed further in the registration process and within the time interval considered for the CM registration trigger detection.

### **G.2.3.5** *RangingRetryType*

This attribute selects the type of ranging retry trigger to be enabled in the Diagnostic Log. A CM failure to perform ranging when a ranging opportunity is scheduled by the CMTS is counted as ranging miss. The ranging retry trigger can be configured to either look at consecutive ranging misses or ranging miss ratio over total number of station maintenance opportunities for a certain time period. Setting this object to 'consecutiveMiss' will select consecutive ranging misses as ranging retry trigger criteria. Setting this object to 'missRatio' will select ranging miss ratio as ranging retry criteria.

### **G.2.3.6** *RangingRetryThrshld*

This attribute indicates the maximum number of consecutive intervals in which the CMTS does not detect a CM acknowledgement of a MAC-layer station maintenance message before the CM is added to the Diagnostic Log. The value of RangingRetryType decides if consecutive ranging miss or ranging miss ratio is used as trigger.

### **G.2.3.7** *RangingRetryStationMaintNum*

This attribute indicates the number of station maintenance opportunities to monitor for the ranging retry trigger. This value implies time intervals in a certain range. DOCSIS specifies that the CMTS schedules ranging opportunities to CMs be sufficiently smaller than T4. There is no fixed formula to derive at a fixed time interval, that is, how many ranging opportunities may be offered to a CM by the CMTS; hence, using the number of station maintenance opportunities provides a ratio with the fixed denominators, while also taking the time factor into consideration.

## **G.2.4** *Log Object*

This object represents the diagnostic information for a CM. An instance of this object represents a single CM summary of the diagnostic information detected by one or more triggers. When the CM object instance already exists and a trigger occurs, the LastUpdateTime and corresponding counter attributes are updated for that CM.

**Table G-4 - Log Object**

Attribute Name	Type	Access	Type Constraints	Units	Default
Id	unsignedInt	key	1..4294967295	N/A	N/A
CmMacAddr	MacAddress	read-only		N/A	N/A
LastUpdateTime	dateTime	read-only		N/A	N/A
CreateTime	dateTime	read-only		N/A	N/A
LastRegTime	dateTime	read-only		N/A	N/A
RegCount	Counter32	read-only		flaps	N/A
RangingRetryCount	Counter32	read-only		retries	N/A

**G.2.4.1 Id**

This attribute contains an instance of the CmtsCmRegStatusId.

**G.2.4.2 CmMacAddr**

This attribute is the MAC address of the CM.

**G.2.4.3 LastUpdateTime**

This attribute is the date and time value that indicates when this instance was last updated.

**G.2.4.4 CreateTime**

This attribute is the date and time value that indicates when this instance was created. When a CM is detected by one of the diagnostic triggers, a new instance will be created provided that there is not already an instance for that CM. If an instance is removed and then re-created, there may be a discontinuity in the statistical objects associated with the instance. This timestamp can be used to detect those discontinuities.

**G.2.4.5 LastRegTime**

This attribute indicates the last date and time the CM registered.

**G.2.4.6 RegCount**

This attribute counts the number of times the registration trigger condition was detected for the CM.

**G.2.4.7 RangingRetryCount**

This attribute counts the number of times the ranging retry trigger condition was detected for the CM.

**G.2.5 LogDetail Object**

This object represents the detailed diagnostic information for a CM. There may be multiple instances for a given CM if more than one state from DetailType is enabled.

This object extends the Log object.

**Table G-5 - LogDetail Object**

Attribute Name	Type	Access	Type Constraints	Units	Default
Id	unsignedInt	key	1..4294967295	N/A	N/A
TypeValue	CmtsCmRegState	key		N/A	N/A
Count	Counter32	read-only		last state	N/A
LastUpdate	dateTime	read-only		N/A	N/A
LastErrorText	AdminString	read-only		N/A	N/A

**G.2.5.1 Id**

This attribute contains an instance of the Id attribute from the Log object.

**G.2.5.2    *TypeValue***

This attribute indicates the detail type this instance is tracking and logging information for a particular CM. For the registration trigger, this list indicates the CM registration state prior to the trigger occurrence. There are no enumerated values for the ranging retry trigger.

**G.2.5.3    *Count***

This attribute counts the number of times a particular state or process is detected by a trigger to be the last state or process before it failed to proceed further within the threshold values of that trigger.

**G.2.5.4    *LastUpdate***

This attribute indicates the date and time when this instance was last updated.

**G.2.5.5    *LastErrorText***

This attribute indicates the Event ID and Event Text (DOCSIS-defined or vendor-specific) of the event condition that triggered the update of the LogDetail object for the TypeValue this instance represents.

The CMTS MAY leave the Event ID empty if the Event ID is not defined.

The format to represent the error text is <Event ID> Event Text

Examples:

<2500001> Failure during state X

<> Unspecified

## Appendix I Sample CCAP XML Configuration (Informative)

### I.1 CCAP XML Configuration File<sup>245</sup>

```

<ccap:ccap xmlns:xsi="http://www.w3.org/2001/XMLSchema-instance" SchemaVersion="2015-10-21"
xsi:schemaLocation="urn:cablelabs:params:xml:ns:yang:ccap ccap@2015-10-21-3_1.xsd"
xmlns:ccap="urn:cablelabs:params:xml:ns:yang:ccap">
  <name>CCAP1</name>
  <description>Vendor A CCAP</description>
  <location>Denver</location>
  <vendor-extension-version>
    <major-version>1</major-version>
    <minor-version>0</minor-version>
  </vendor-extension-version>
  <chassis>
    <decryptor>
      <decryptor-index>1</decryptor-index>
      <cw-timeout>10</cw-timeout>
      <ecmd-usage>
        <ecmd-usage-index>1</ecmd-usage-index>
        <priority>1</priority>
        <ecmd-ref>1</ecmd-ref>
      </ecmd-usage>
    </decryptor>
    <fiber-node-config>
      <fiber-node-config-index>1</fiber-node-config-index>
      <fiber-node-name>Fiber Node 1</fiber-node-name>
      <ds-rf-port-ref>
        <slot>1</slot>
        <ds-rf-port>0</ds-rf-port>
      </ds-rf-port-ref>
      <us-rf-port-ref>
        <slot>9</slot>
        <us-rf-port>0</us-rf-port>
      </us-rf-port-ref>
    </fiber-node-config>
    <fiber-node-config>
      <fiber-node-config-index>2</fiber-node-config-index>
      <fiber-node-name>Fiber Node 2</fiber-node-name>
      <ds-rf-port-ref>
        <slot>1</slot>
        <ds-rf-port>1</ds-rf-port>
      </ds-rf-port-ref>
      <us-rf-port-ref>
        <slot>9</slot>
        <us-rf-port>1</us-rf-port>
      </us-rf-port-ref>
    </fiber-node-config>
    <fiber-node-config>
      <fiber-node-config-index>8</fiber-node-config-index>
      <fiber-node-name>Fiber Node 8</fiber-node-name>
      <ds-rf-port-ref>
        <slot>1</slot>
        <ds-rf-port>7</ds-rf-port>
      </ds-rf-port-ref>
      <us-rf-port-ref>
        <slot>9</slot>
        <us-rf-port>7</us-rf-port>
      </us-rf-port-ref>
    </fiber-node-config>
    <fiber-node-config>
      <fiber-node-config-index>9</fiber-node-config-index>
      <fiber-node-name>Fiber Node 9</fiber-node-name>
      <ds-rf-port-ref>
        <slot>3</slot>
        <ds-rf-port>0</ds-rf-port>

```

<sup>245</sup> Modified per CCAP-OSSiv3.1-N-15.1237-1 on 2/23/15 by KB; per CCAP-OSSiv3.1-N-15.1348-1 on 8/13/15 by KB; per CCAP-OSSiv3.1-N-15.1349-3 on 8/13/15 by KB.

```

</ds-rf-port-ref>
<us-rf-port-ref>
  <slot>11</slot>
  <us-rf-port>0</us-rf-port>
</us-rf-port-ref>
</fiber-node-config>
<fiber-node-config>
  <fiber-node-config-index>10</fiber-node-config-index>
  <fiber-node-name>Fiber Node10</fiber-node-name>
  <ds-rf-port-ref>
    <slot>3</slot>
    <ds-rf-port>1</ds-rf-port>
  </ds-rf-port-ref>
  <us-rf-port-ref>
    <slot>11</slot>
    <us-rf-port>1</us-rf-port>
  </us-rf-port-ref>
</fiber-node-config>
<fiber-node-config>
  <fiber-node-config-index>16</fiber-node-config-index>
  <fiber-node-name>Fiber Node 16</fiber-node-name>
  <ds-rf-port-ref>
    <slot>3</slot>
    <ds-rf-port>7</ds-rf-port>
  </ds-rf-port-ref>
  <us-rf-port-ref>
    <slot>11</slot>
    <us-rf-port>7</us-rf-port>
  </us-rf-port-ref>
</fiber-node-config>
<slot>
  <slot-number>1</slot-number>
  <rf-line-card>
    <rf-card>
      <line-card-name>Downstream RF Line Card 1</line-card-name>
      <admin-state>up</admin-state>
      <protected-by>2</protected-by>
    </rf-card>
    <encryptor>
      <encryptor-index>1</encryptor-index>
      <ca-encryptor-type>motorola</ca-encryptor-type>
      <ecm-timeout>10</ecm-timeout>
      <clear-stream-timeout>10</clear-stream-timeout>
      <ecmg-usage>
        <ecmg-usage-index>1</ecmg-usage-index>
        <priority>1</priority>
        <ecmg-ref>1</ecmg-ref>
      </ecmg-usage>
    </encryptor>
    <enable-udp-map-encryption>2</enable-udp-map-encryption>
    <ds-rf-port>
      <port-number>0</port-number>
      <rf-mute>false</rf-mute>
      <base-channel-power>550</base-channel-power>
      <admin-state>up</admin-state>
      <down-channel>
        <channel-index>1</channel-index>
        <admin-state>up</admin-state>
        <power-adjust>-2</power-adjust>
        <frequency>555000000</frequency>
        <rf-mute>false</rf-mute>
        <qam-alias>FN1_VOD1</qam-alias>
        <erm-advertising>true</erm-advertising>
        <erm-managed>
          <input-map-group-name>Group1</input-map-group-name>
          <phy-lock-parameters>interleaver</phy-lock-parameters>
          <allocation-type>linear vod sdv</allocation-type>
          <encryption-capability>
            <encryption-capability-index>1</encryption-capability-index>
            <ca-encryptor>motorola</ca-encryptor>
            <encryption-scheme>aes</encryption-scheme>
          </encryption-capability>
        </erm-managed>
      </down-channel>
    </ds-rf-port>
  </slot>

```

```

        <key-length>56</key-length>
    </encryption-capability>
    <erm-name>ERM-1</erm-name>
</erm-managed>
<video>
    <video-output-tsid>1</video-output-tsid>
    <video-phy-profile-index>1</video-phy-profile-index>
</video>
</down-channel>
<down-channel>
    <channel-index>2</channel-index>
    <admin-state>up</admin-state>
    <power-adjust>-2</power-adjust>
    <frequency>561000000</frequency>
    <rf-mute>>false</rf-mute>
    <qam-alias>FN1_VOD2</qam-alias>
    <erm-advertising>>true</erm-advertising>
    <erm-managed>
        <input-map-group-name>Group2</input-map-group-name>
        <phy-lock-parameters>interleaver</phy-lock-parameters>
        <allocation-type>linear vod sdv</allocation-type>
        <encryption-capability>
            <encryption-capability-index>1</encryption-capability-index>
            <ca-encryptor>motorola</ca-encryptor>
            <encryption-scheme>aes</encryption-scheme>
            <key-length>56</key-length>
        </encryption-capability>
        <erm-name>ERM-1</erm-name>
    </erm-managed>
    <video>
        <video-output-tsid>2</video-output-tsid>
    </video>
</down-channel>
<down-channel>
    <channel-index>16</channel-index>
    <admin-state>up</admin-state>
    <power-adjust>0</power-adjust>
    <frequency>645000000</frequency>
    <rf-mute>>false</rf-mute>
    <qam-alias>FN1_VOD16</qam-alias>
    <erm-advertising>>true</erm-advertising>
    <erm-managed>
        <input-map-group-name>Group3</input-map-group-name>
        <phy-lock-parameters>interleaver</phy-lock-parameters>
        <allocation-type>vod sdv</allocation-type>
        <encryption-capability>
            <encryption-capability-index>1</encryption-capability-index>
            <ca-encryptor>motorola</ca-encryptor>
            <encryption-scheme>aes</encryption-scheme>
            <key-length>56</key-length>
        </encryption-capability>
        <erm-name>ERM-1</erm-name>
    </erm-managed>
    <video>
        <video-output-tsid>16</video-output-tsid>
    </video>
</down-channel>
<down-channel>
    <channel-index>17</channel-index>
    <admin-state>up</admin-state>
    <power-adjust>0</power-adjust>
    <frequency>651000000</frequency>
    <rf-mute>>false</rf-mute>
    <qam-alias/>
    <erm-advertising>>false</erm-advertising>
    <docsis>
        <id>0</id>
        <provisioned-attribute-mask>bonded</provisioned-attribute-mask>
    </docsis>
</down-channel>
</down-channel>

```

```

    <channel-index>18</channel-index>
    <admin-state>up</admin-state>
    <power-adjust>0</power-adjust>
    <frequency>657000000</frequency>
    <rf-mute>>false</rf-mute>
    <qam-alias/>
    <erm-advertising>>false</erm-advertising>
    <docsis>
      <id>0</id>
      <provisioned-attribute-mask>bonded</provisioned-attribute-mask>
      <docsis-phy-profile-index>1</docsis-phy-profile-index>
    </docsis>
  </down-channel>
  <down-channel>
    <channel-index>32</channel-index>
    <admin-state>up</admin-state>
    <power-adjust>2</power-adjust>
    <frequency>741000000</frequency>
    <rf-mute>>false</rf-mute>
    <qam-alias/>
    <erm-advertising>>false</erm-advertising>
    <docsis>
      <id>0</id>
      <provisioned-attribute-mask>bonded</provisioned-attribute-mask>
    </docsis>
  </down-channel>
</ds-rf-port>
<ds-rf-port>
  <port-number>1</port-number>
  <rf-mute>>false</rf-mute>
  <base-channel-power>550</base-channel-power>
  <admin-state>up</admin-state>
  <down-channel>
    <channel-index>1</channel-index>
    <admin-state>up</admin-state>
    <power-adjust>-2</power-adjust>
    <frequency>555000000</frequency>
    <rf-mute>>false</rf-mute>
    <qam-alias>FN2_VOD1</qam-alias>
    <erm-advertising>>true</erm-advertising>
    <erm-managed>
      <input-map-group-name>Group1</input-map-group-name>
      <phy-lock-parameters>interleaver</phy-lock-parameters>
      <allocation-type>linear</allocation-type>
      <encryption-capability>
        <encryption-capability-index>1</encryption-capability-index>
        <ca-encryptor>motorola</ca-encryptor>
        <encryption-scheme>aes</encryption-scheme>
        <key-length>56</key-length>
      </encryption-capability>
      <erm-name>ERM-2</erm-name>
    </erm-managed>
    <video>
      <video-output-tsid>65</video-output-tsid>
    </video>
  </down-channel>
  <down-channel>
    <channel-index>2</channel-index>
    <admin-state>up</admin-state>
    <power-adjust>-2</power-adjust>
    <frequency>561000000</frequency>
    <rf-mute>>false</rf-mute>
    <qam-alias>FN2_VOD2</qam-alias>
    <erm-advertising>>true</erm-advertising>
    <erm-managed>
      <input-map-group-name>Group2</input-map-group-name>
      <phy-lock-parameters>interleaver</phy-lock-parameters>
      <allocation-type>vod</allocation-type>
      <encryption-capability>
        <encryption-capability-index>1</encryption-capability-index>
        <ca-encryptor>motorola</ca-encryptor>

```



```

        <encryption-scheme>aes</encryption-scheme>
        <key-length>56</key-length>
    </encryption-capability>
    <erm-name>ERM-2</erm-name>
</erm-managed>
<video>
    <video-output-tsid>66</video-output-tsid>
</video>
</down-channel>
<down-channel>
    <channel-index>16</channel-index>
    <admin-state>up</admin-state>
    <power-adjust>0</power-adjust>
    <frequency>645000000</frequency>
    <rf-mute>>false</rf-mute>
    <qam-alias>FN2_VOD16</qam-alias>
    <erm-advertising>>true</erm-advertising>
    <erm-managed>
        <input-map-group-name>Group3</input-map-group-name>
        <phy-lock-parameters>interleaver</phy-lock-parameters>
        <allocation-type>vod sdv</allocation-type>
        <encryption-capability>
            <encryption-capability-index>1</encryption-capability-index>
            <ca-encryptor>motorola</ca-encryptor>
            <encryption-scheme>aes</encryption-scheme>
            <key-length>56</key-length>
        </encryption-capability>
        <erm-name>ERM-2</erm-name>
    </erm-managed>
    <video>
        <video-output-tsid>80</video-output-tsid>
    </video>
</down-channel>
<down-channel>
    <channel-index>17</channel-index>
    <admin-state>up</admin-state>
    <power-adjust>0</power-adjust>
    <frequency>651000000</frequency>
    <rf-mute>>false</rf-mute>
    <qam-alias/>
    <erm-advertising>>false</erm-advertising>
    <docsis>
        <id>0</id>
        <provisioned-attribute-mask>bonded</provisioned-attribute-mask>
    </docsis>
</down-channel>
<down-channel>
    <channel-index>18</channel-index>
    <admin-state>up</admin-state>
    <power-adjust>0</power-adjust>
    <frequency>657000000</frequency>
    <rf-mute>>false</rf-mute>
    <qam-alias/>
    <erm-advertising>>false</erm-advertising>
    <docsis>
        <id>0</id>
        <provisioned-attribute-mask>bonded</provisioned-attribute-mask>
    </docsis>
</down-channel>
<down-channel>
    <channel-index>32</channel-index>
    <admin-state>up</admin-state>
    <power-adjust>2</power-adjust>
    <frequency>741000000</frequency>
    <rf-mute>>false</rf-mute>
    <qam-alias/>
    <erm-advertising>>false</erm-advertising>
    <docsis>
        <id>0</id>
        <provisioned-attribute-mask>bonded</provisioned-attribute-mask>
    </docsis>

```

```

    </down-channel>
  </ds-rf-port>
  <ds-rf-port>
    <port-number>7</port-number>
    <rf-mute>>false</rf-mute>
    <base-channel-power>550</base-channel-power>
    <admin-state>up</admin-state>
    <down-channel>
      <channel-index>1</channel-index>
      <admin-state>up</admin-state>
      <power-adjust>-2</power-adjust>
      <frequency>555000000</frequency>
      <rf-mute>>false</rf-mute>
      <qam-alias>FN8_VOD1</qam-alias>
      <erm-advertising>>true</erm-advertising>
      <erm-managed>
        <input-map-group-name>Group1</input-map-group-name>
        <phy-lock-parameters>interleaver</phy-lock-parameters>
        <allocation-type>linear vod sdv</allocation-type>
        <encryption-capability>
          <encryption-capability-index>1</encryption-capability-index>
          <ca-encryptor>motorola</ca-encryptor>
          <encryption-scheme>aes</encryption-scheme>
          <key-length>56</key-length>
        </encryption-capability>
        <erm-name>ERM-1</erm-name>
      </erm-managed>
      <video>
        <video-output-tsid>449</video-output-tsid>
      </video>
    </down-channel>
  <down-channel>
    <channel-index>2</channel-index>
    <admin-state>up</admin-state>
    <power-adjust>-2</power-adjust>
    <frequency>561000000</frequency>
    <rf-mute>>false</rf-mute>
    <qam-alias>FN8_VOD2</qam-alias>
    <erm-advertising>>true</erm-advertising>
    <erm-managed>
      <input-map-group-name>Group2</input-map-group-name>
      <phy-lock-parameters>interleaver</phy-lock-parameters>
      <allocation-type>linear vod sdv</allocation-type>
      <encryption-capability>
        <encryption-capability-index>1</encryption-capability-index>
        <ca-encryptor>motorola</ca-encryptor>
        <encryption-scheme>aes</encryption-scheme>
        <key-length>56</key-length>
      </encryption-capability>
      <erm-name>ERM-1</erm-name>
    </erm-managed>
    <video>
      <video-output-tsid>450</video-output-tsid>
    </video>
  </down-channel>
  <down-channel>
    <channel-index>16</channel-index>
    <admin-state>up</admin-state>
    <power-adjust>0</power-adjust>
    <frequency>645000000</frequency>
    <rf-mute>>false</rf-mute>
    <qam-alias>FN8_VOD16</qam-alias>
    <erm-advertising>>true</erm-advertising>
    <erm-managed>
      <input-map-group-name>Group3</input-map-group-name>
      <phy-lock-parameters>interleaver</phy-lock-parameters>
      <allocation-type>linear vod sdv</allocation-type>
      <encryption-capability>
        <encryption-capability-index>1</encryption-capability-index>
        <ca-encryptor>motorola</ca-encryptor>
        <encryption-scheme>aes</encryption-scheme>

```

```

        <key-length>56</key-length>
    </encryption-capability>
    <erm-name>ERM-1</erm-name>
</erm-managed>
<video>
    <video-output-tsid>464</video-output-tsid>
</video>
</down-channel>
<down-channel>
    <channel-index>17</channel-index>
    <admin-state>up</admin-state>
    <power-adjust>0</power-adjust>
    <frequency>651000000</frequency>
    <rf-mute>>false</rf-mute>
    <qam-alias/>
    <erm-advertising>>false</erm-advertising>
    <docsis>
        <id>0</id>
        <provisioned-attribute-mask>bonded</provisioned-attribute-mask>
    </docsis>
</down-channel>
<down-channel>
    <channel-index>18</channel-index>
    <admin-state>up</admin-state>
    <power-adjust>0</power-adjust>
    <frequency>657000000</frequency>
    <rf-mute>>false</rf-mute>
    <qam-alias/>
    <erm-advertising>>false</erm-advertising>
    <docsis>
        <id>0</id>
        <provisioned-attribute-mask>bonded</provisioned-attribute-mask>
    </docsis>
</down-channel>
<down-channel>
    <channel-index>32</channel-index>
    <admin-state>up</admin-state>
    <power-adjust>2</power-adjust>
    <frequency>741000000</frequency>
    <rf-mute>>false</rf-mute>
    <qam-alias/>
    <erm-advertising>>false</erm-advertising>
    <docsis>
        <id>0</id>
        <provisioned-attribute-mask>bonded</provisioned-attribute-mask>
    </docsis>
</down-channel>
</ds-rf-port>
</rf-line-card>
</slot>
<slot>
    <slot-number>2</slot-number>
    <rf-line-card>
        <rf-card>
            <line-card-name>Downstream RF Line Card Spare</line-card-name>
            <admin-state>up</admin-state>
        </rf-card>
    </rf-line-card>
</slot>
<slot>
    <slot-number>3</slot-number>
    <rf-line-card>
        <rf-card>
            <line-card-name>Downstream RF Line Card 3</line-card-name>
            <admin-state>up</admin-state>
            <protected-by>2</protected-by>
        </rf-card>
        <encryptor>
            <encryptor-index>1</encryptor-index>
            <ca-encryptor-type>motorola</ca-encryptor-type>
            <ecm-timeout>10</ecm-timeout>
        </encryptor>
    </rf-line-card>
</slot>

```

```

<clear-stream-timeout>10</clear-stream-timeout>
<ecmg-usage>
  <ecmg-usage-index>1</ecmg-usage-index>
  <priority>1</priority>
  <ecmg-ref>1</ecmg-ref>
</ecmg-usage>
</encryptor>
<ds-rf-port>
  <port-number>0</port-number>
  <rf-mute>>false</rf-mute>
  <base-channel-power>550</base-channel-power>
  <admin-state>up</admin-state>
  <down-channel>
    <channel-index>1</channel-index>
    <admin-state>up</admin-state>
    <power-adjust>-2</power-adjust>
    <frequency>555000000</frequency>
    <rf-mute>>false</rf-mute>
    <qam-alias>FN9_VOD1</qam-alias>
    <erm-advertising>>true</erm-advertising>
    <erm-managed>
      <input-map-group-name>Group1</input-map-group-name>
      <phy-lock-parameters>interleaver</phy-lock-parameters>
      <allocation-type>linear vod sdv</allocation-type>
      <encryption-capability>
        <encryption-capability-index>1</encryption-capability-index>
        <ca-encryptor>motorola</ca-encryptor>
        <encryption-scheme>aes</encryption-scheme>
        <key-length>56</key-length>
      </encryption-capability>
      <erm-name>ERM-1</erm-name>
    </erm-managed>
    <video>
      <video-output-tsid>513</video-output-tsid>
    </video>
  </down-channel>
<down-channel>
  <channel-index>2</channel-index>
  <admin-state>up</admin-state>
  <power-adjust>-2</power-adjust>
  <frequency>561000000</frequency>
  <rf-mute>>false</rf-mute>
  <qam-alias>FN9_VOD2</qam-alias>
  <erm-advertising>>true</erm-advertising>
  <erm-managed>
    <input-map-group-name>Group2</input-map-group-name>
    <phy-lock-parameters>interleaver</phy-lock-parameters>
    <allocation-type>linear vod sdv</allocation-type>
    <encryption-capability>
      <encryption-capability-index>1</encryption-capability-index>
      <ca-encryptor>motorola</ca-encryptor>
      <encryption-scheme>aes</encryption-scheme>
      <key-length>56</key-length>
    </encryption-capability>
    <erm-name>ERM-1</erm-name>
  </erm-managed>
  <video>
    <video-output-tsid>514</video-output-tsid>
  </video>
</down-channel>
<down-channel>
  <channel-index>16</channel-index>
  <admin-state>up</admin-state>
  <power-adjust>0</power-adjust>
  <frequency>645000000</frequency>
  <rf-mute>>false</rf-mute>
  <qam-alias>FN9_VOD16</qam-alias>
  <erm-advertising>>true</erm-advertising>
  <erm-managed>
    <input-map-group-name>Group3</input-map-group-name>
    <phy-lock-parameters>interleaver</phy-lock-parameters>

```

```

    <allocation-type>linear vod sdv</allocation-type>
    <encryption-capability>
      <encryption-capability-index>1</encryption-capability-index>
      <ca-encryptor>motorola</ca-encryptor>
      <encryption-scheme>aes</encryption-scheme>
      <key-length>56</key-length>
    </encryption-capability>
    <erm-name>ERM-1</erm-name>
  </erm-managed>
</video>
  <video-output-tsid>528</video-output-tsid>
</video>
</down-channel>
<down-channel>
  <channel-index>17</channel-index>
  <admin-state>up</admin-state>
  <power-adjust>0</power-adjust>
  <frequency>651000000</frequency>
  <rf-mute>>false</rf-mute>
  <qam-alias/>
  <erm-advertising>>false</erm-advertising>
  <docsis>
    <id>0</id>
    <provisioned-attribute-mask>bonded</provisioned-attribute-mask>
  </docsis>
</down-channel>
<down-channel>
  <channel-index>18</channel-index>
  <admin-state>up</admin-state>
  <power-adjust>0</power-adjust>
  <frequency>657000000</frequency>
  <rf-mute>>false</rf-mute>
  <qam-alias/>
  <erm-advertising>>false</erm-advertising>
  <docsis>
    <id>0</id>
    <provisioned-attribute-mask>bonded</provisioned-attribute-mask>
  </docsis>
</down-channel>
<down-channel>
  <channel-index>32</channel-index>
  <admin-state>up</admin-state>
  <power-adjust>2</power-adjust>
  <frequency>741000000</frequency>
  <rf-mute>>false</rf-mute>
  <qam-alias/>
  <erm-advertising>>false</erm-advertising>
  <docsis>
    <id>0</id>
    <provisioned-attribute-mask>bonded</provisioned-attribute-mask>
  </docsis>
</down-channel>
</ds-rf-port>
<ds-rf-port>
  <port-number>1</port-number>
  <rf-mute>>false</rf-mute>
  <base-channel-power>550</base-channel-power>
  <admin-state>up</admin-state>
  <down-channel>
    <channel-index>1</channel-index>
    <admin-state>up</admin-state>
    <power-adjust>-2</power-adjust>
    <frequency>555000000</frequency>
    <rf-mute>>false</rf-mute>
    <qam-alias>FN10_VOD1</qam-alias>
    <erm-advertising>true</erm-advertising>
  <erm-managed>
    <input-map-group-name>Group1</input-map-group-name>
    <phy-lock-parameters>interleaver</phy-lock-parameters>
    <allocation-type>linear vod sdv</allocation-type>
    <encryption-capability>

```

```

        <encryption-capability-index>1</encryption-capability-index>
        <ca-encryptor>motorola</ca-encryptor>
        <encryption-scheme>aes</encryption-scheme>
        <key-length>56</key-length>
    </encryption-capability>
    <erm-name>ERM-1</erm-name>
</erm-managed>
<video>
    <video-output-tsid>577</video-output-tsid>
</video>
</down-channel>
<down-channel>
    <channel-index>2</channel-index>
    <admin-state>up</admin-state>
    <power-adjust>-2</power-adjust>
    <frequency>561000000</frequency>
    <rf-mute>>false</rf-mute>
    <qam-alias>FN10_VOD2</qam-alias>
    <erm-advertising>>true</erm-advertising>
    <erm-managed>
        <input-map-group-name>Group2</input-map-group-name>
        <phy-lock-parameters>interleaver</phy-lock-parameters>
        <allocation-type>linear vod sdv</allocation-type>
        <encryption-capability>
            <encryption-capability-index>1</encryption-capability-index>
            <ca-encryptor>motorola</ca-encryptor>
            <encryption-scheme>aes</encryption-scheme>
            <key-length>56</key-length>
        </encryption-capability>
        <erm-name>ERM-1</erm-name>
    </erm-managed>
    <video>
        <video-output-tsid>578</video-output-tsid>
    </video>
</down-channel>
<down-channel>
    <channel-index>16</channel-index>
    <admin-state>up</admin-state>
    <power-adjust>0</power-adjust>
    <frequency>645000000</frequency>
    <rf-mute>>false</rf-mute>
    <qam-alias>FN10_VOD16</qam-alias>
    <erm-advertising>>true</erm-advertising>
    <erm-managed>
        <input-map-group-name>Group3</input-map-group-name>
        <phy-lock-parameters>interleaver</phy-lock-parameters>
        <allocation-type>linear vod sdv</allocation-type>
        <encryption-capability>
            <encryption-capability-index>1</encryption-capability-index>
            <ca-encryptor>motorola</ca-encryptor>
            <encryption-scheme>aes</encryption-scheme>
            <key-length>56</key-length>
        </encryption-capability>
        <erm-name>ERM-1</erm-name>
    </erm-managed>
    <video>
        <video-output-tsid>598</video-output-tsid>
    </video>
</down-channel>
<down-channel>
    <channel-index>17</channel-index>
    <admin-state>up</admin-state>
    <power-adjust>0</power-adjust>
    <frequency>651000000</frequency>
    <rf-mute>>false</rf-mute>
    <qam-alias/>
    <erm-advertising>>false</erm-advertising>
    <docsis>
        <id>0</id>
        <provisioned-attribute-mask>bonded</provisioned-attribute-mask>
    </docsis>

```

```

</down-channel>
<down-channel>
  <channel-index>18</channel-index>
  <admin-state>up</admin-state>
  <power-adjust>0</power-adjust>
  <frequency>657000000</frequency>
  <rf-mute>>false</rf-mute>
  <qam-alias/>
  <erm-advertising>>false</erm-advertising>
  <docsis>
    <id>0</id>
    <provisioned-attribute-mask>bonded</provisioned-attribute-mask>
  </docsis>
</down-channel>
<down-channel>
  <channel-index>32</channel-index>
  <admin-state>up</admin-state>
  <power-adjust>2</power-adjust>
  <frequency>741000000</frequency>
  <rf-mute>>false</rf-mute>
  <qam-alias/>
  <erm-advertising>>false</erm-advertising>
  <docsis>
    <id>0</id>
    <provisioned-attribute-mask>bonded</provisioned-attribute-mask>
  </docsis>
</down-channel>
<ofdm-exclusions>
  <start-freq>850000000</start-freq>
  <end-freq>870000000</end-freq>
</ofdm-exclusions>
<ofdm-ncp-exclusions>
  <start-freq>940000000</start-freq>
  <end-freq>950000000</end-freq>
</ofdm-ncp-exclusions>
<ofdm-channel>
  <ofdm-channel-index>0</ofdm-channel-index>
  <lower-bdry-freq>800000000</lower-bdry-freq>
  <upper-bdry-freq>992000000</upper-bdry-freq>
  <plc-blk-freq>900000000</plc-blk-freq>
  <cyclic-prefix>512</cyclic-prefix>
  <rolloff-period>128</rolloff-period>
  <time-interleaver-depth>16</time-interleaver-depth>
  <subcarrier-spacing>50khz</subcarrier-spacing>
  <pilot-scale-factor>50</pilot-scale-factor>
  <ofdm-profile>
    <ofdm-profile-index>0</ofdm-profile-index>
    <ofdm-modulation-default>qam64</ofdm-modulation-default>
  </ofdm-profile>
  <ofdm-profile>
    <ofdm-profile-index>1</ofdm-profile-index>
    <ofdm-modulation-default>qam4096</ofdm-modulation-default>
    <ofdm-subcarrier>
      <start-frequency>820000000</start-frequency>
      <end-frequency>840000000</end-frequency>
      <ofdm-main-modulation>qam1024</ofdm-main-modulation>
    </ofdm-subcarrier>
    <ofdm-subcarrier>
      <start-frequency>941000000</start-frequency>
      <end-frequency>944000000</end-frequency>
      <ofdm-main-modulation>qam512</ofdm-main-modulation>
    </ofdm-subcarrier>
  </ofdm-profile>
  <ofdm-profile>
    <ofdm-profile-index>2</ofdm-profile-index>
    <ofdm-modulation-default>qam1024</ofdm-modulation-default>
    <ofdm-subcarrier>
      <start-frequency>820000000</start-frequency>
      <end-frequency>840000000</end-frequency>
      <skip>>true</skip>
      <ofdm-main-modulation>qam1024</ofdm-main-modulation>
    </ofdm-subcarrier>
  </ofdm-profile>

```

```

        <ofdm-skip-modulation>qam512</ofdm-skip-modulation>
    </ofdm-subcarrier>
</ofdm-profile>
<ofdm-profile>
    <ofdm-profile-index>3</ofdm-profile-index>
    <ofdm-modulation-default>qam256</ofdm-modulation-default>
</ofdm-profile>
<ofdm-profile>
    <ofdm-profile-index>255</ofdm-profile-index>
    <ofdm-modulation-default>qam64</ofdm-modulation-default>
    <ofdm-subcarrier>
        <start-frequency>820000000</start-frequency>
        <end-frequency>840000000</end-frequency>
        <ofdm-main-modulation>zero-bit-load</ofdm-main-modulation>
    </ofdm-subcarrier>
</ofdm-profile>
</ofdm-channel>
</ds-rf-port>
<ds-rf-port>
    <port-number>7</port-number>
    <rf-mute>>false</rf-mute>
    <base-channel-power>550</base-channel-power>
    <admin-state>up</admin-state>
    <down-channel>
        <channel-index>1</channel-index>
        <admin-state>up</admin-state>
        <power-adjust>-2</power-adjust>
        <frequency>555000000</frequency>
        <rf-mute>>false</rf-mute>
        <qam-alias>FN16_VOD1</qam-alias>
        <erm-advertising>>true</erm-advertising>
        <erm-managed>
            <input-map-group-name>Group1</input-map-group-name>
            <phy-lock-parameters>interleaver</phy-lock-parameters>
            <allocation-type>linear vod sdv</allocation-type>
            <encryption-capability>
                <encryption-capability-index>1</encryption-capability-index>
                <ca-encryptor>motorola</ca-encryptor>
                <encryption-scheme>aes</encryption-scheme>
                <key-length>56</key-length>
            </encryption-capability>
            <erm-name>ERM-1</erm-name>
        </erm-managed>
        <video>
            <video-output-tsid>961</video-output-tsid>
        </video>
    </down-channel>
</down-channel>
<down-channel>
    <channel-index>2</channel-index>
    <admin-state>up</admin-state>
    <power-adjust>-2</power-adjust>
    <frequency>561000000</frequency>
    <rf-mute>>false</rf-mute>
    <qam-alias>FN16_VOD2</qam-alias>
    <erm-advertising>>true</erm-advertising>
    <erm-managed>
        <input-map-group-name>Group2</input-map-group-name>
        <phy-lock-parameters>interleaver</phy-lock-parameters>
        <allocation-type>linear vod sdv</allocation-type>
        <encryption-capability>
            <encryption-capability-index>1</encryption-capability-index>
            <ca-encryptor>motorola</ca-encryptor>
            <encryption-scheme>aes</encryption-scheme>
            <key-length>56</key-length>
        </encryption-capability>
        <erm-name>ERM-1</erm-name>
    </erm-managed>
    <video>
        <video-output-tsid>962</video-output-tsid>
    </video>
</down-channel>

```



```

<down-channel>
  <channel-index>16</channel-index>
  <admin-state>up</admin-state>
  <power-adjust>0</power-adjust>
  <frequency>645000000</frequency>
  <rf-mute>>false</rf-mute>
  <qam-alias>FN16_VOD16</qam-alias>
  <erm-advertising>>true</erm-advertising>
  <erm-managed>
    <input-map-group-name>Group3</input-map-group-name>
    <phy-lock-parameters>interleaver</phy-lock-parameters>
    <allocation-type>linear vod sdv</allocation-type>
    <encryption-capability>
      <encryption-capability-index>1</encryption-capability-index>
      <ca-encryptor>motorola</ca-encryptor>
      <encryption-scheme>aes</encryption-scheme>
      <key-length>56</key-length>
    </encryption-capability>
    <erm-name>ERM-1</erm-name>
  </erm-managed>
  <video>
    <video-output-tsid>976</video-output-tsid>
  </video>
</down-channel>
<down-channel>
  <channel-index>17</channel-index>
  <admin-state>up</admin-state>
  <power-adjust>0</power-adjust>
  <frequency>651000000</frequency>
  <rf-mute>>false</rf-mute>
  <qam-alias/>
  <erm-advertising>>false</erm-advertising>
  <docsis>
    <id>0</id>
    <provisioned-attribute-mask>bonded</provisioned-attribute-mask>
  </docsis>
</down-channel>
<down-channel>
  <channel-index>18</channel-index>
  <admin-state>up</admin-state>
  <power-adjust>0</power-adjust>
  <frequency>657000000</frequency>
  <rf-mute>>false</rf-mute>
  <qam-alias/>
  <erm-advertising>>false</erm-advertising>
  <docsis>
    <id>0</id>
    <provisioned-attribute-mask>bonded</provisioned-attribute-mask>
  </docsis>
</down-channel>
<down-channel>
  <channel-index>32</channel-index>
  <admin-state>up</admin-state>
  <power-adjust>2</power-adjust>
  <frequency>741000000</frequency>
  <rf-mute>>false</rf-mute>
  <qam-alias/>
  <erm-advertising>>false</erm-advertising>
  <docsis>
    <id>0</id>
    <provisioned-attribute-mask>bonded</provisioned-attribute-mask>
  </docsis>
</down-channel>
</ds-rf-port>
</rf-line-card>
</slot>
<slot>
  <slot-number>6</slot-number>
  <sre-line-card>
    <sre-card>
      <line-card-name>SRE 6</line-card-name>
    </sre-card>
  </sre-line-card>
</slot>

```

```

    <admin-state>up</admin-state>
    <protected-by>7</protected-by>
  </sre-card>
  <one-gb-ethernet-port>
    <port-number>0</port-number>
    <admin-state>up</admin-state>
    <ip-interface>
      <ip-interface-name>eth6/0</ip-interface-name>
      <primary-ipv4>
        <ip-address>10.10.10.99/32</ip-address>
      </primary-ipv4>
      <ingress-acl>acl1</ingress-acl>
    </ip-interface>
    <speed>auto</speed>
  </one-gb-ethernet-port>
  <ten-gb-ethernet-port>
    <port-number>3</port-number>
    <admin-state>up</admin-state>
    <ip-interface>
      <ip-interface-name>eth6/3</ip-interface-name>
      <primary-ipv4>
        <ip-address>66.77.88.99/32</ip-address>
      </primary-ipv4>
      <egress-acl>acl2</egress-acl>
    </ip-interface>
  </ten-gb-ethernet-port>
</sre-line-card>
</slot>
<slot>
  <slot-number>7</slot-number>
  <sre-line-card>
    <sre-card>
      <line-card-name>SRE 7</line-card-name>
      <admin-state>up</admin-state>
      <protected-by>6</protected-by>
    </sre-card>
    <one-gb-ethernet-port>
      <port-number>0</port-number>
      <admin-state>up</admin-state>
      <up-down-trap-enabled>true</up-down-trap-enabled>
      <ip-interface>
        <ip-interface-name>eth7/0</ip-interface-name>
        <primary-ipv4>
          <ip-address>10.10.10.100/32</ip-address>
        </primary-ipv4>
      </ip-interface>
      <speed>auto</speed>
    </one-gb-ethernet-port>
    <ten-gb-ethernet-port>
      <port-number>6</port-number>
      <admin-state>up</admin-state>
      <up-down-trap-enabled>true</up-down-trap-enabled>
      <ip-interface>
        <ip-interface-name>eth7/6</ip-interface-name>
        <primary-ipv4>
          <ip-address>66.77.88.100/32</ip-address>
        </primary-ipv4>
      </ip-interface>
    </ten-gb-ethernet-port>
  </sre-line-card>
</slot>
<slot>
  <slot-number>8</slot-number>
  <epon-line-card>
    <epon-card>
      <line-card-name>PON 8</line-card-name>
      <admin-state>up</admin-state>
    </epon-card>
  </epon-line-card>
</slot>
<slot>

```

```

<slot-number>9</slot-number>
<rf-line-card>
  <rf-card>
    <line-card-name>Upstream RF Line Card 9</line-card-name>
    <admin-state>up</admin-state>
    <protected-by>10</protected-by>
  </rf-card>
  <us-rf-port>
    <port-number>0</port-number>
    <admin-state>up</admin-state>
    <upstream-physical-channel>
      <channel-index>0</channel-index>
      <admin-state>up</admin-state>
      <frequency>6800000</frequency>
      <width>3200000</width>
      <power-level>0</power-level>
      <upstream-logical-channel>
        <upstream-logical-channel-index>0</upstream-logical-channel-index>
        <admin-state>up</admin-state>
        <channel-id>0</channel-id>
        <slot-size>2</slot-size>
        <ranging-backoff-start>2</ranging-backoff-start>
        <ranging-backoff-end>8</ranging-backoff-end>
        <transmit-backoff-start>2</transmit-backoff-start>
        <transmit-backoff-end>8</transmit-backoff-end>
        <pre-equalization-enable>true</pre-equalization-enable>
        <provisioned-attribute-mask>bonded</provisioned-attribute-mask>
        <power-level-adjust>0</power-level-adjust>
        <modulation>1</modulation>
        <atdma-logical-channel/>
      </upstream-logical-channel>
    </upstream-physical-channel>
    <upstream-physical-channel>
      <channel-index>1</channel-index>
      <admin-state>up</admin-state>
      <frequency>11200000</frequency>
      <width>6400000</width>
      <power-level>0</power-level>
      <upstream-logical-channel>
        <upstream-logical-channel-index>0</upstream-logical-channel-index>
        <admin-state>up</admin-state>
        <channel-id>0</channel-id>
        <slot-size>2</slot-size>
        <ranging-backoff-start>2</ranging-backoff-start>
        <ranging-backoff-end>8</ranging-backoff-end>
        <transmit-backoff-start>2</transmit-backoff-start>
        <transmit-backoff-end>8</transmit-backoff-end>
        <pre-equalization-enable>true</pre-equalization-enable>
        <provisioned-attribute-mask>bonded</provisioned-attribute-mask>
        <power-level-adjust>0</power-level-adjust>
        <modulation>1</modulation>
        <atdma-logical-channel/>
      </upstream-logical-channel>
    </upstream-physical-channel>
    <upstream-physical-channel>
      <channel-index>5</channel-index>
      <admin-state>up</admin-state>
      <frequency>36800000</frequency>
      <width>6400000</width>
      <power-level>0</power-level>
      <upstream-logical-channel>
        <upstream-logical-channel-index>0</upstream-logical-channel-index>
        <admin-state>up</admin-state>
        <channel-id>0</channel-id>
        <slot-size>2</slot-size>
        <ranging-backoff-start>2</ranging-backoff-start>
        <ranging-backoff-end>8</ranging-backoff-end>
        <transmit-backoff-start>2</transmit-backoff-start>
        <transmit-backoff-end>8</transmit-backoff-end>
        <pre-equalization-enable>true</pre-equalization-enable>
        <provisioned-attribute-mask>bonded</provisioned-attribute-mask>

```

```

    <power-level-adjust>0</power-level-adjust>
    <modulation>1</modulation>
    <atdma-logical-channel/>
  </upstream-logical-channel>
</upstream-physical-channel>
<ofdma-exclusions>
  <start-freq>11000000</start-freq>
  <end-freq>13000000</end-freq>
</ofdma-exclusions>
<ofdma-channel>
  <ofdma-channel-index>0</ofdma-channel-index>
  <lower-bdry-freq>10000000</lower-bdry-freq>
  <upper-bdry-freq>34000000</upper-bdry-freq>
  <provisioned-attribute-mask>bonded</provisioned-attribute-mask>
  <ranging-backoff-start>2</ranging-backoff-start>
  <ranging-backoff-end>8</ranging-backoff-end>
  <transmit-backoff-start>2</transmit-backoff-start>
  <transmit-backoff-end>8</transmit-backoff-end>
  <ofdma-chan-template>0</ofdma-chan-template>
</ofdma-channel>
</us-rf-port>
<us-rf-port>
  <port-number>1</port-number>
  <admin-state>up</admin-state>
  <upstream-physical-channel>
    <channel-index>0</channel-index>
    <admin-state>up</admin-state>
    <frequency>6800000</frequency>
    <width>3200000</width>
    <power-level>0</power-level>
    <upstream-logical-channel>
      <upstream-logical-channel-index>0</upstream-logical-channel-index>
      <admin-state>up</admin-state>
      <channel-id>0</channel-id>
      <slot-size>2</slot-size>
      <ranging-backoff-start>2</ranging-backoff-start>
      <ranging-backoff-end>8</ranging-backoff-end>
      <transmit-backoff-start>2</transmit-backoff-start>
      <transmit-backoff-end>8</transmit-backoff-end>
      <pre-equalization-enable>true</pre-equalization-enable>
      <provisioned-attribute-mask>bonded</provisioned-attribute-mask>
      <power-level-adjust>0</power-level-adjust>
      <modulation>1</modulation>
      <atdma-logical-channel/>
    </upstream-logical-channel>
  </upstream-physical-channel>
  <upstream-physical-channel>
    <channel-index>1</channel-index>
    <admin-state>up</admin-state>
    <frequency>11200000</frequency>
    <width>6400000</width>
    <power-level>0</power-level>
    <upstream-logical-channel>
      <upstream-logical-channel-index>0</upstream-logical-channel-index>
      <admin-state>up</admin-state>
      <channel-id>0</channel-id>
      <slot-size>2</slot-size>
      <ranging-backoff-start>2</ranging-backoff-start>
      <ranging-backoff-end>8</ranging-backoff-end>
      <transmit-backoff-start>2</transmit-backoff-start>
      <transmit-backoff-end>8</transmit-backoff-end>
      <pre-equalization-enable>true</pre-equalization-enable>
      <provisioned-attribute-mask>bonded</provisioned-attribute-mask>
      <power-level-adjust>0</power-level-adjust>
      <modulation>1</modulation>
      <atdma-logical-channel/>
    </upstream-logical-channel>
  </upstream-physical-channel>
  <upstream-physical-channel>
    <channel-index>5</channel-index>
    <admin-state>up</admin-state>

```

```

<frequency>36800000</frequency>
<width>6400000</width>
<power-level>0</power-level>
<upstream-logical-channel>
  <upstream-logical-channel-index>0</upstream-logical-channel-index>
  <admin-state>up</admin-state>
  <channel-id>0</channel-id>
  <slot-size>2</slot-size>
  <ranging-backoff-start>2</ranging-backoff-start>
  <ranging-backoff-end>8</ranging-backoff-end>
  <transmit-backoff-start>2</transmit-backoff-start>
  <transmit-backoff-end>8</transmit-backoff-end>
  <pre-equalization-enable>true</pre-equalization-enable>
  <provisioned-attribute-mask>bonded</provisioned-attribute-mask>
  <power-level-adjust>0</power-level-adjust>
  <modulation>1</modulation>
</atdma-logical-channel/>
</upstream-logical-channel>
</upstream-physical-channel>
</us-rf-port>
<us-rf-port>
  <port-number>7</port-number>
  <admin-state>up</admin-state>
  <upstream-physical-channel>
    <channel-index>0</channel-index>
    <admin-state>up</admin-state>
    <frequency>6800000</frequency>
    <width>3200000</width>
    <power-level>0</power-level>
    <upstream-logical-channel>
      <upstream-logical-channel-index>0</upstream-logical-channel-index>
      <admin-state>up</admin-state>
      <channel-id>0</channel-id>
      <slot-size>2</slot-size>
      <ranging-backoff-start>2</ranging-backoff-start>
      <ranging-backoff-end>8</ranging-backoff-end>
      <transmit-backoff-start>2</transmit-backoff-start>
      <transmit-backoff-end>8</transmit-backoff-end>
      <pre-equalization-enable>true</pre-equalization-enable>
      <provisioned-attribute-mask>bonded</provisioned-attribute-mask>
      <power-level-adjust>0</power-level-adjust>
      <modulation>1</modulation>
    </atdma-logical-channel/>
    </upstream-logical-channel>
  </upstream-physical-channel>
  <upstream-physical-channel>
    <channel-index>1</channel-index>
    <admin-state>up</admin-state>
    <frequency>11200000</frequency>
    <width>6400000</width>
    <power-level>0</power-level>
    <upstream-logical-channel>
      <upstream-logical-channel-index>0</upstream-logical-channel-index>
      <admin-state>up</admin-state>
      <channel-id>0</channel-id>
      <slot-size>2</slot-size>
      <ranging-backoff-start>2</ranging-backoff-start>
      <ranging-backoff-end>8</ranging-backoff-end>
      <transmit-backoff-start>2</transmit-backoff-start>
      <transmit-backoff-end>8</transmit-backoff-end>
      <pre-equalization-enable>true</pre-equalization-enable>
      <provisioned-attribute-mask>bonded</provisioned-attribute-mask>
      <power-level-adjust>0</power-level-adjust>
      <modulation>1</modulation>
    </atdma-logical-channel/>
    </upstream-logical-channel>
  </upstream-physical-channel>
  <upstream-physical-channel>
    <channel-index>5</channel-index>
    <admin-state>up</admin-state>
    <frequency>36800000</frequency>

```

```

    <width>6400000</width>
    <power-level>0</power-level>
    <upstream-logical-channel>
      <upstream-logical-channel-index>0</upstream-logical-channel-index>
      <admin-state>up</admin-state>
      <channel-id>0</channel-id>
      <slot-size>2</slot-size>
      <ranging-backoff-start>2</ranging-backoff-start>
      <ranging-backoff-end>8</ranging-backoff-end>
      <transmit-backoff-start>2</transmit-backoff-start>
      <transmit-backoff-end>8</transmit-backoff-end>
      <pre-equalization-enable>true</pre-equalization-enable>
      <provisioned-attribute-mask>bonded</provisioned-attribute-mask>
      <power-level-adjust>0</power-level-adjust>
      <modulation>1</modulation>
    </atdma-logical-channel/>
  </upstream-logical-channel>
</upstream-physical-channel>
</us-rf-port>
</rf-line-card>
</slot>
<slot>
  <slot-number>10</slot-number>
  <rf-line-card>
    <rf-card>
      <line-card-name>Upstream RF Line Card Spare</line-card-name>
      <admin-state>up</admin-state>
    </rf-card>
  </rf-line-card>
</slot>
<slot>
  <slot-number>11</slot-number>
  <rf-line-card>
    <rf-card>
      <line-card-name>Upstream RF Line Card 11</line-card-name>
      <admin-state>up</admin-state>
      <protected-by>10</protected-by>
    </rf-card>
    <us-rf-port>
      <port-number>0</port-number>
      <admin-state>up</admin-state>
      <upstream-physical-channel>
        <channel-index>0</channel-index>
        <admin-state>up</admin-state>
        <frequency>6800000</frequency>
        <width>3200000</width>
        <power-level>0</power-level>
        <upstream-logical-channel>
          <upstream-logical-channel-index>0</upstream-logical-channel-index>
          <admin-state>up</admin-state>
          <channel-id>1</channel-id>
          <slot-size>2</slot-size>
          <ranging-backoff-start>12</ranging-backoff-start>
          <ranging-backoff-end>16</ranging-backoff-end>
          <transmit-backoff-start>12</transmit-backoff-start>
          <transmit-backoff-end>16</transmit-backoff-end>
          <pre-equalization-enable>true</pre-equalization-enable>
          <provisioned-attribute-mask>bonded</provisioned-attribute-mask>
          <power-level-adjust>0</power-level-adjust>
          <modulation>1</modulation>
        </atdma-logical-channel/>
      </upstream-logical-channel>
    </upstream-physical-channel>
  <upstream-physical-channel>
    <channel-index>1</channel-index>
    <admin-state>up</admin-state>
    <frequency>11200000</frequency>
    <width>6400000</width>
    <power-level>0</power-level>
    <upstream-logical-channel>
      <upstream-logical-channel-index>0</upstream-logical-channel-index>

```

```

    <admin-state>up</admin-state>
    <channel-id>2</channel-id>
    <slot-size>4</slot-size>
    <ranging-backoff-start>2</ranging-backoff-start>
    <ranging-backoff-end>8</ranging-backoff-end>
    <transmit-backoff-start>5</transmit-backoff-start>
    <transmit-backoff-end>8</transmit-backoff-end>
    <pre-equalization-enable>true</pre-equalization-enable>
    <provisioned-attribute-mask>bonded</provisioned-attribute-mask>
    <power-level-adjust>0</power-level-adjust>
    <modulation>1</modulation>
    <atdma-logical-channel/>
  </upstream-logical-channel>
</upstream-physical-channel>
<upstream-physical-channel>
  <channel-index>5</channel-index>
  <admin-state>up</admin-state>
  <frequency>36800000</frequency>
  <width>6400000</width>
  <power-level>0</power-level>
  <upstream-logical-channel>
    <upstream-logical-channel-index>0</upstream-logical-channel-index>
    <admin-state>up</admin-state>
    <channel-id>2</channel-id>
    <slot-size>4</slot-size>
    <ranging-backoff-start>2</ranging-backoff-start>
    <ranging-backoff-end>8</ranging-backoff-end>
    <transmit-backoff-start>5</transmit-backoff-start>
    <transmit-backoff-end>8</transmit-backoff-end>
    <pre-equalization-enable>true</pre-equalization-enable>
    <provisioned-attribute-mask>bonded</provisioned-attribute-mask>
    <power-level-adjust>0</power-level-adjust>
    <modulation>1</modulation>
    <atdma-logical-channel/>
  </upstream-logical-channel>
</upstream-physical-channel>
</us-rf-port>
<us-rf-port>
  <port-number>1</port-number>
  <admin-state>up</admin-state>
  <upstream-physical-channel>
    <channel-index>0</channel-index>
    <admin-state>up</admin-state>
    <frequency>6800000</frequency>
    <width>3200000</width>
    <power-level>0</power-level>
    <upstream-logical-channel>
      <upstream-logical-channel-index>0</upstream-logical-channel-index>
      <admin-state>up</admin-state>
      <channel-id>0</channel-id>
      <slot-size>2</slot-size>
      <ranging-backoff-start>2</ranging-backoff-start>
      <ranging-backoff-end>8</ranging-backoff-end>
      <transmit-backoff-start>2</transmit-backoff-start>
      <transmit-backoff-end>8</transmit-backoff-end>
      <pre-equalization-enable>true</pre-equalization-enable>
      <provisioned-attribute-mask>bonded</provisioned-attribute-mask>
      <power-level-adjust>0</power-level-adjust>
      <modulation>1</modulation>
      <atdma-logical-channel/>
    </upstream-logical-channel>
  </upstream-physical-channel>
<upstream-physical-channel>
  <channel-index>1</channel-index>
  <admin-state>up</admin-state>
  <frequency>11200000</frequency>
  <width>6400000</width>
  <power-level>0</power-level>
  <upstream-logical-channel>
    <upstream-logical-channel-index>0</upstream-logical-channel-index>
    <admin-state>up</admin-state>

```

```

    <channel-id>0</channel-id>
    <slot-size>2</slot-size>
    <ranging-backoff-start>2</ranging-backoff-start>
    <ranging-backoff-end>8</ranging-backoff-end>
    <transmit-backoff-start>2</transmit-backoff-start>
    <transmit-backoff-end>8</transmit-backoff-end>
    <pre-equalization-enable>true</pre-equalization-enable>
    <provisioned-attribute-mask>bonded</provisioned-attribute-mask>
    <power-level-adjust>0</power-level-adjust>
    <modulation>1</modulation>
    <atdma-logical-channel/>
  </upstream-logical-channel>
</upstream-physical-channel>
<upstream-physical-channel>
  <channel-index>5</channel-index>
  <admin-state>up</admin-state>
  <frequency>36800000</frequency>
  <width>6400000</width>
  <power-level>0</power-level>
  <upstream-logical-channel>
    <upstream-logical-channel-index>0</upstream-logical-channel-index>
    <admin-state>up</admin-state>
    <channel-id>0</channel-id>
    <slot-size>2</slot-size>
    <ranging-backoff-start>2</ranging-backoff-start>
    <ranging-backoff-end>8</ranging-backoff-end>
    <transmit-backoff-start>2</transmit-backoff-start>
    <transmit-backoff-end>8</transmit-backoff-end>
    <pre-equalization-enable>true</pre-equalization-enable>
    <provisioned-attribute-mask>bonded</provisioned-attribute-mask>
    <power-level-adjust>0</power-level-adjust>
    <modulation>2</modulation>
    <atdma-logical-channel/>
  </upstream-logical-channel>
</upstream-physical-channel>
</us-rf-port>
<us-rf-port>
  <port-number>7</port-number>
  <admin-state>up</admin-state>
  <upstream-physical-channel>
    <channel-index>0</channel-index>
    <admin-state>up</admin-state>
    <frequency>6800000</frequency>
    <width>3200000</width>
    <power-level>0</power-level>
    <upstream-logical-channel>
      <upstream-logical-channel-index>0</upstream-logical-channel-index>
      <admin-state>up</admin-state>
      <channel-id>0</channel-id>
      <slot-size>2</slot-size>
      <ranging-backoff-start>2</ranging-backoff-start>
      <ranging-backoff-end>8</ranging-backoff-end>
      <transmit-backoff-start>2</transmit-backoff-start>
      <transmit-backoff-end>8</transmit-backoff-end>
      <pre-equalization-enable>true</pre-equalization-enable>
      <provisioned-attribute-mask>bonded</provisioned-attribute-mask>
      <power-level-adjust>0</power-level-adjust>
      <modulation>1</modulation>
      <atdma-logical-channel/>
    </upstream-logical-channel>
  </upstream-physical-channel>
<upstream-physical-channel>
  <channel-index>1</channel-index>
  <admin-state>up</admin-state>
  <frequency>11200000</frequency>
  <width>6400000</width>
  <power-level>0</power-level>
  <upstream-logical-channel>
    <upstream-logical-channel-index>0</upstream-logical-channel-index>
    <admin-state>up</admin-state>
    <channel-id>0</channel-id>

```



```

    <slot-size>2</slot-size>
    <ranging-backoff-start>2</ranging-backoff-start>
    <ranging-backoff-end>8</ranging-backoff-end>
    <transmit-backoff-start>2</transmit-backoff-start>
    <transmit-backoff-end>8</transmit-backoff-end>
    <pre-equalization-enable>true</pre-equalization-enable>
    <provisioned-attribute-mask>bonded</provisioned-attribute-mask>
    <power-level-adjust>0</power-level-adjust>
    <modulation>1</modulation>
    <atdma-logical-channel/>
  </upstream-logical-channel>
</upstream-physical-channel>
<upstream-physical-channel>
  <channel-index>5</channel-index>
  <admin-state>up</admin-state>
  <frequency>36800000</frequency>
  <width>6400000</width>
  <power-level>0</power-level>
  <upstream-logical-channel>
    <upstream-logical-channel-index>0</upstream-logical-channel-index>
    <admin-state>up</admin-state>
    <channel-id>0</channel-id>
    <slot-size>2</slot-size>
    <ranging-backoff-start>2</ranging-backoff-start>
    <ranging-backoff-end>8</ranging-backoff-end>
    <transmit-backoff-start>2</transmit-backoff-start>
    <transmit-backoff-end>8</transmit-backoff-end>
    <pre-equalization-enable>true</pre-equalization-enable>
    <provisioned-attribute-mask>bonded</provisioned-attribute-mask>
    <power-level-adjust>0</power-level-adjust>
    <modulation>1</modulation>
    <atdma-logical-channel/>
  </upstream-logical-channel>
</upstream-physical-channel>
</us-rf-port>
</rf-line-card>
</slot>
<video-phy-profile>
  <phy-index>0</phy-index>
  <modulation>qam256</modulation>
  <interleaver-depth>fecI128J1</interleaver-depth>
  <downstream-phy-standard>j83annexB</downstream-phy-standard>
  <spectrum-inversion>>false</spectrum-inversion>
</video-phy-profile>
<video-phy-profile>
  <phy-index>1</phy-index>
  <modulation>qam64</modulation>
  <interleaver-depth>fecI128J4</interleaver-depth>
  <spectrum-inversion>true</spectrum-inversion>
  <symbol-rate-override>40000000</symbol-rate-override>
</video-phy-profile>
<docsis-phy-profile>
  <phy-index>0</phy-index>
  <modulation>qam256</modulation>
  <interleaver-depth>fecI32J4</interleaver-depth>
  <downstream-phy-standard>j83annexB</downstream-phy-standard>
</docsis-phy-profile>
<docsis-phy-profile>
  <phy-index>1</phy-index>
  <modulation>qam64</modulation>
  <interleaver-depth>fecI8J16</interleaver-depth>
</docsis-phy-profile>
</chassis>
<docsis>
  <docs-global>
    <maximum-scheduled-codes-enabled>>false</maximum-scheduled-codes-enabled>
    <l2-vpn-global-enabled>>false</l2-vpn-global-enabled>
  </docs-global>
  <cm-vendor-oui>
    <cm-oui>FFFFFF</cm-oui>
    <cm-vendor-name>CableLabs</cm-vendor-name>
  </cm-vendor-oui>
</docsis>

```

```

</cm-vendor-oui>
<ofdm-guard-band>
  <guard-band-index>1</guard-band-index>
  <guard-band-width>1000000</guard-band-width>
</ofdm-guard-band>
<ofdm-guard-band>
  <guard-band-index>0</guard-band-index>
  <guard-band-width>0</guard-band-width>
</ofdm-guard-band>
<docs-security>
  <sav-config-list>
    <sav-config-list-name>SecCfgSavList1</sav-config-list-name>
    <sav-rule>
      <rule-id>1</rule-id>
      <prefix-address>10.193.1.1/32</prefix-address>
    </sav-rule>
  </sav-config-list>
  <sav-config-list>
    <sav-config-list-name>SecCfgSavList2</sav-config-list-name>
    <sav-rule>
      <rule-id>1</rule-id>
      <prefix-address>10.194.1.1/32</prefix-address>
    </sav-rule>
    <sav-rule>
      <rule-id>2</rule-id>
      <prefix-address>10.194.2.1/32</prefix-address>
    </sav-rule>
  </sav-config-list>
  <cmts-sav-control>
    <cm-authentication-enable>true</cm-authentication-enable>
  </cmts-sav-control>
  <cmts-server-config>
    <tftp-options>net-addr</tftp-options>
    <config-file-learning-enabled>true</config-file-learning-enabled>
  </cmts-server-config>
  <cmts-encrypt>
    <encrypt-alg-priority>aes128CbcMode des56CbcMode des40CbcMode</encrypt-alg-priority>
  </cmts-encrypt>
  <cmts-certificate>
    <cert-revocation-method>crl-and-ocsp</cert-revocation-method>
  </cmts-certificate>
  <cmts-cert-revocation-list>
    <url>crl.verisign.net</url>
    <refresh-interval>10080</refresh-interval>
  </cmts-cert-revocation-list>
  <cmts-cm-eae-exclusion>
    <cmts-cm-eae-exclusion-id>1</cmts-cm-eae-exclusion-id>
    <mac-address>59:94:6B:7C:2A:CC</mac-address>
    <mac-address-mask>FF:FF:FF:FF:FF:FF</mac-address-mask>
  </cmts-cm-eae-exclusion>
  <cmts-online-cert-status-protocol>
    <url>ocsp.verisign.net</url>
    <signature-bypass>>false</signature-bypass>
  </cmts-online-cert-status-protocol>
  <sys-bpi-config>
    <sys-default-authentication-lifetime>5</sys-default-authentication-lifetime>
    <sys-default-tek-lifetime>5</sys-default-tek-lifetime>
  </sys-bpi-config>
</docs-security>
<docs-subscriber-management>
  <base>
    <cpe-max-ipv4>16</cpe-max-ipv4>
    <cpe-max-ipv6>16</cpe-max-ipv6>
    <cpe-active>true</cpe-active>
    <cpe-learnable>true</cpe-learnable>
    <subscriber-downstream-filter>1</subscriber-downstream-filter>
    <subscriber-upstream-filter>0</subscriber-upstream-filter>
    <cm-downstream-filter>0</cm-downstream-filter>
    <cm-upstream-filter>0</cm-upstream-filter>
    <ps-downstream-filter>0</ps-downstream-filter>
    <ps-upstream-filter>0</ps-upstream-filter>
  </base>

```

```

    <mta-downstream-filter>0</mta-downstream-filter>
    <mta-upstream-filter>0</mta-upstream-filter>
    <stb-downstream-filter>0</stb-downstream-filter>
    <stb-upstream-filter>0</stb-upstream-filter>
  </base>
  <filter-group>
    <group-id>1</group-id>
    <rule-id>1</rule-id>
    <filter-action>permit</filter-action>
    <priority>1</priority>
    <ip-tos-low>00</ip-tos-low>
    <ip-tos-high>FF</ip-tos-high>
    <ip-tos-mask>FF</ip-tos-mask>
    <ip-protocol>257</ip-protocol>
    <source-address>10.10.10.0/10</source-address>
    <destination-address>192.168.8.1/10</destination-address>
    <source-port-start>16</source-port-start>
    <source-port-end>128</source-port-end>
    <destination-port-start>16</destination-port-start>
    <destination-port-end>128</destination-port-end>
    <destination-mac-address>AA:BB:CC:DD:00:00</destination-mac-address>
    <destination-mac-mask>FF:FF:FF:FF:00:00</destination-mac-mask>
    <source-mac-address>FF:FF:FF:FF:FF:FF</source-mac-address>
    <ethernet-protocol-id>mac</ethernet-protocol-id>
    <ethernet-protocol>0800</ethernet-protocol>
    <user-priority-low>0</user-priority-low>
    <user-priority-high>7</user-priority-high>
    <vlan-id>0</vlan-id>
    <flow-label>0</flow-label>
    <cm-interface-mask>eCm</cm-interface-mask>
  </filter-group>
</docs-subscriber-management>
<docs-qos>
  <aqm-global-default-latency-target>100</aqm-global-default-latency-target>
  <aqm-global-enable>true</aqm-global-enable>
  <service-class>
    <service-class-name>ServiceClass1</service-class-name>
    <priority>0</priority>
    <max-traffic-rate>0</max-traffic-rate>
    <max-traffic-burst>3044</max-traffic-burst>
    <min-reserved-rate>0</min-reserved-rate>
    <min-reserved-packet>12</min-reserved-packet>
    <max-concatenated-burst>1522</max-concatenated-burst>
    <nominal-polling-interval>0</nominal-polling-interval>
    <tolerated-poll-jitter>0</tolerated-poll-jitter>
    <unsolicited-grant-size>0</unsolicited-grant-size>
    <nominal-grant-interval>0</nominal-grant-interval>
    <tolerated-grant-jitter>0</tolerated-grant-jitter>
    <grants-per-interval>0</grants-per-interval>
    <max-latency>0</max-latency>
    <active-timeout>0</active-timeout>
    <admitted-timeout>200</admitted-timeout>
    <scheduling-type>best-effort</scheduling-type>
    <request-policy>00000000</request-policy>
    <tos-and-mask>00</tos-and-mask>
    <tos-or-mask>00</tos-or-mask>
    <direction>upstream</direction>
    <dscp-overwrite>-1</dscp-overwrite>
    <required-attribute-mask>bonded</required-attribute-mask>
    <forbidden-attribute-mask>bonded</forbidden-attribute-mask>
    <attribute-aggregate-rule-mask>00000000</attribute-aggregate-rule-mask>
    <application-id>12</application-id>
    <multiplier-contention-request-window>8</multiplier-contention-request-window>
    <multiplier-bytes-requested>4</multiplier-bytes-requested>
    <max-requests-per-sid-cluster>0</max-requests-per-sid-cluster>
    <max-outstanding-bytes-per-sid-cluster>0</max-outstanding-bytes-per-sid-cluster>
    <max-total-bytes-requested-per-sid-cluster>0</max-total-bytes-requested-per-sid-cluster>
    <max-time-in-sid-cluster>0</max-time-in-sid-cluster>
    <peak-traffic-rate>0</peak-traffic-rate>
    <ds-resequencing>resequencing-dsid</ds-resequencing>
    <minimum-buffer>0</minimum-buffer>
  </service-class>
</docs-qos>

```

```

    <target-buffer>0</target-buffer>
    <maximum-buffer>4294967295</maximum-buffer>
    <sf-aqm-enable>true</sf-aqm-enable>
    <sf-aqm-latency-target>80</sf-aqm-latency-target>
</service-class>
<qos-profile>
  <qos-profile-index>1</qos-profile-index>
  <priority>0</priority>
  <max-up-bandwidth>0</max-up-bandwidth>
  <guaranteed-up-bandwidth>0</guaranteed-up-bandwidth>
  <max-down-bandwidth>0</max-down-bandwidth>
  <baseline-privacy>>false</baseline-privacy>
  <max-transmit-burst>0</max-transmit-burst>
</qos-profile>
<asf-qos-profile>
  <asf-name>asf1</asf-name>
  <aggregate-traffic-rate>10000000</aggregate-traffic-rate>
</asf-qos-profile>
  <asf-qos-profile>
    <asf-name>asf2</asf-name>
    <aggregate-traffic-rate>40000000</aggregate-traffic-rate>
  </asf-qos-profile>
<iatc-profile>
  <iatc-name>iatc1</iatc-name>
  <max-traffic-rate>50000000</max-traffic-rate>
  <iatc-app-id>
    <app-id>9865</app-id>
  </iatc-app-id>
  <iatc-app-id>
    <app-id>45</app-id>
  </iatc-app-id>
</iatc-profile>
  <iatc-profile>
    <iatc-name>iatc2</iatc-name>
    <max-traffic-rate>30000000</max-traffic-rate>
    <iatc-scen>
      <scen>SCN1</scen>
    </iatc-scen>
  </iatc-profile>
</docs-qos>
<docs-multicast-qos>
  <default-group-service-class>ServiceClass1</default-group-service-class>
  <group-config>
    <group-config-id>1</group-config-id>
    <rule-priority>1</rule-priority>
    <source-prefix-address>10.10.10.10/32</source-prefix-address>
    <group-prefix-address>231.10.10.10/32</group-prefix-address>
    <tos-low>00</tos-low>
    <tos-high>00</tos-high>
    <tos-mask>FF</tos-mask>
    <group-qos-config-id>1</group-qos-config-id>
    <group-encryption-config-id>1</group-encryption-config-id>
  </group-config>
  <group-encryption-config>
    <group-encryption-config-id>1</group-encryption-config-id>
    <control>cmts</control>
    <algorithm>des40-cbc-mode</algorithm>
  </group-encryption-config>
  <group-qos-config>
    <group-qos-config-id>1</group-qos-config-id>
    <service-class-name>ServiceClass1</service-class-name>
    <qos-control>single-session</qos-control>
    <aggregated-session-limit>1600</aggregated-session-limit>
    <application-id>12</application-id>
  </group-qos-config>
</docs-multicast-qos>
<docs-mac-domain>
  <downstream-bonding-group>
    <bonding-group-name>1</bonding-group-name>
    <sf-provisioned-attribute-mask>bonded</sf-provisioned-attribute-mask>
    <dsid-resequencing-warning-threshold>255</dsid-resequencing-warning-threshold>
  </downstream-bonding-group>
</docs-mac-domain>

```

```

<dsid-resequencing-wait-time>255</dsid-resequencing-wait-time>
<docsis-down-channel-ref>
  <slot>1</slot>
  <ds-rf-port>0</ds-rf-port>
  <down-channel>17</down-channel>
</docsis-down-channel-ref>
<docsis-down-channel-ref>
  <slot>1</slot>
  <ds-rf-port>0</ds-rf-port>
  <down-channel>18</down-channel>
</docsis-down-channel-ref>
<docsis-down-channel-ref>
  <slot>1</slot>
  <ds-rf-port>0</ds-rf-port>
  <down-channel>32</down-channel>
</docsis-down-channel-ref>
</downstream-bonding-group>
<deny-cm>
  <device-mac-address>00:43:21:00:19:73</device-mac-address>
</deny-cm>
<deny-cm>
  <device-mac-address>00:43:21:00:99:88</device-mac-address>
</deny-cm>
<mac-domain>
  <mac-domain-name>MacDomain1</mac-domain-name>
  <ip-provisioning-mode>ipv4-only</ip-provisioning-mode>
  <admin-state>up</admin-state>
  <up-down-trap-enabled>>false</up-down-trap-enabled>
  <mdd-interval>2000</mdd-interval>
  <cm-status-event-control-enabled>>true</cm-status-event-control-enabled>
  <upstream-frequency-range>standard</upstream-frequency-range>
  <multicast-dsid-forward-enabled>>true</multicast-dsid-forward-enabled>
  <multiple-receive-channel-mode-enabled>>true</multiple-receive-channel-mode-enabled>
  <multiple-transmit-channel-mode-enabled>>true</multiple-transmit-channel-mode-enabled>
  <early-auth-encrypt-control>enable-eae-ranging-based-enforcement</early-auth-encrypt-
control>
  <tftp-proxy-enabled>>true</tftp-proxy-enabled>
  <source-address-verification-enabled>>true</source-address-verification-enabled>
  <cm-udc-enabled>>false</cm-udc-enabled>
  <send-udc-rules-enabled>>false</send-udc-rules-enabled>
  <service-type-id-list>00</service-type-id-list>
  <bpi2-enforce-control>qosCfgFileWithBpi2Enabled</bpi2-enforce-control>
  <energy-mgt-lx1-enabled>>true</energy-mgt-lx1-enabled>
  <dls-enable>true</dls-enable>
    <config-file-shared-secret>secret</config-file-shared-secret>
    <shared-secret-clear-key>true</shared-secret-clear-key>
  <md-bpi-config>
    <default-authentication-lifetime>7</default-authentication-lifetime>
    <default-tek-lifetime>7</default-tek-lifetime>
  </md-bpi-config>
  <upstream-bonding-group>
    <bonding-group-name>UsBondingGroup1</bonding-group-name>
    <sf-provisioned-attribute-mask>bonded</sf-provisioned-attribute-mask>
    <upstream-logical-channel-ref>
      <slot>9</slot>
      <us-rf-port>0</us-rf-port>
      <upstream-physical-channel>0</upstream-physical-channel>
      <upstream-logical-channel>0</upstream-logical-channel>
    </upstream-logical-channel-ref>
    <upstream-logical-channel-ref>
      <slot>9</slot>
      <us-rf-port>0</us-rf-port>
      <upstream-physical-channel>1</upstream-physical-channel>
      <upstream-logical-channel>0</upstream-logical-channel>
    </upstream-logical-channel-ref>
    <ofdma-channel-ref>
      <slot>9</slot>
      <us-rf-port>0</us-rf-port>
      <ofdma-channel>0</ofdma-channel>
    </ofdma-channel-ref>
  </upstream-bonding-group>

```

```

<rcc-configuration>
  <rcp-id>0010000003</rcp-id>
  <rcc-cfg-id>1</rcc-cfg-id>
  <vendor-specific/>
  <description>VendorA</description>
  <receive-channel-configuration>
    <receive-channel-id>1</receive-channel-id>
    <primary-downstream-indicator>primary-ds-channel</primary-downstream-indicator>
    <rc-rm-connectivity-identifier>1</rc-rm-connectivity-identifier>
    <docsis-down-channel-ref>
      <slot>1</slot>
      <ds-rf-port>0</ds-rf-port>
      <down-channel>17</down-channel>
    </docsis-down-channel-ref>
  </receive-channel-configuration>
  <receive-channel-configuration>
    <receive-channel-id>2</receive-channel-id>
    <primary-downstream-indicator>primary-ds-channel</primary-downstream-indicator>
    <rc-rm-connectivity-identifier>1</rc-rm-connectivity-identifier>
    <docsis-down-channel-ref>
      <slot>1</slot>
      <ds-rf-port>0</ds-rf-port>
      <down-channel>18</down-channel>
    </docsis-down-channel-ref>
  </receive-channel-configuration>
  <receive-channel-configuration>
    <receive-channel-id>3</receive-channel-id>
    <primary-downstream-indicator>backup-primary-channel</primary-downstream-indicator>
    <rc-rm-connectivity-identifier>2</rc-rm-connectivity-identifier>
    <docsis-down-channel-ref>
      <slot>1</slot>
      <ds-rf-port>0</ds-rf-port>
      <down-channel>32</down-channel>
    </docsis-down-channel-ref>
  </receive-channel-configuration>
  <receive-module-configuration>
    <receive-module-id>1</receive-module-id>
    <rm-rm-connectivity-id>17</rm-rm-connectivity-id>
    <first-center-frequency>651000000</first-center-frequency>
  </receive-module-configuration>
  <receive-module-configuration>
    <receive-module-id>2</receive-module-id>
    <rm-rm-connectivity-id>17</rm-rm-connectivity-id>
    <first-center-frequency>741000000</first-center-frequency>
  </receive-module-configuration>
  <receive-module-configuration>
    <receive-module-id>17</receive-module-id>
    <rm-rm-connectivity-id>0</rm-rm-connectivity-id>
  </receive-module-configuration>
</rcc-configuration>
<cmts-mac-interface-config>
  <sync-interval>1</sync-interval>
  <ucd-interval>1</ucd-interval>
  <invited-ranging-attempts>1</invited-ranging-attempts>
  <im-insertion-interval>1</im-insertion-interval>
  <docsis11-concatenation-enabled>true</docsis11-concatenation-enabled>
  <docsis11-fragmentation-enabled>true</docsis11-fragmentation-enabled>
</cmts-mac-interface-config>
<upstream-physical-channel-ref>
  <slot>9</slot>
  <us-rf-port>0</us-rf-port>
  <upstream-physical-channel>0</upstream-physical-channel>
</upstream-physical-channel-ref>
<upstream-physical-channel-ref>
  <slot>9</slot>
  <us-rf-port>0</us-rf-port>
  <upstream-physical-channel>1</upstream-physical-channel>
</upstream-physical-channel-ref>
<upstream-physical-channel-ref>
  <slot>9</slot>
  <us-rf-port>0</us-rf-port>

```

```

    <upstream-physical-channel>5</upstream-physical-channel>
  </upstream-physical-channel-ref>
  <non-primary-capable-ds>
    <slot>1</slot>
    <ds-rf-port>0</ds-rf-port>
    <down-channel>32</down-channel>
  </non-primary-capable-ds>
  <primary-capable-ds>
    <slot>1</slot>
    <ds-rf-port>0</ds-rf-port>
    <down-channel>17</down-channel>
  </primary-capable-ds>
  <primary-capable-ds>
    <slot>1</slot>
    <ds-rf-port>0</ds-rf-port>
    <down-channel>18</down-channel>
  </primary-capable-ds>
  <ds-ofdm-channel-list>
    <slot>3</slot>
    <ds-rf-port>1</ds-rf-port>
    <ofdm-channel>0</ofdm-channel>
  </ds-ofdm-channel-list>
</mac-domain>
</docs-mac-domain>
<docs-multicast-authorization>
  <control>
    <enable>disable</enable>
    <default-profile-name-list>taglist</default-profile-name-list>
    <default-action>deny</default-action>
    <default-max-number-sessions>0</default-max-number-sessions>
  </control>
  <profiles>
    <mcast-auth-profile-name>AuthProfName1</mcast-auth-profile-name>
    <description>This profile</description>
    <session-rule>
      <session-rule-name>sessionRule1</session-rule-name>
      <id>1</id>
      <priority>0</priority>
      <source-prefix-address>10.10.10.10/32</source-prefix-address>
      <group-prefix-address>10.10.10.10/24</group-prefix-address>
      <authorization-action>deny</authorization-action>
    </session-rule>
  </profiles>
</docs-multicast-authorization>
<docs-if>
  <modulation-profile>
    <modulation-index>1</modulation-index>
    <interval-usage-code>
      <usage-code>shortData</usage-code>
      <modulation>qpsk</modulation>
      <preamble-length>3</preamble-length>
      <differential-encoding>>false</differential-encoding>
      <fec-error-correction>0</fec-error-correction>
      <fec-codeword-length>32</fec-codeword-length>
      <scrambler-seed>0</scrambler-seed>
      <max-burst-size>4</max-burst-size>
      <last-codeword-shortened>>true</last-codeword-shortened>
      <scrambler>>false</scrambler>
      <byte-interleaver-depth>1</byte-interleaver-depth>
      <byte-interleaver-block-size>18</byte-interleaver-block-size>
      <preamble>qpsk0</preamble>
      <tcm-error-correction-on>>false</tcm-error-correction-on>
      <scdma-interleaver-step-size>1</scdma-interleaver-step-size>
      <scdma-spreader-enable>>true</scdma-spreader-enable>
      <scdma-subframe-codes>1</scdma-subframe-codes>
      <channel-type>tdma</channel-type>
    </interval-usage-code>
  </modulation-profile>
</docs-if>
<docs-packet-cable>
  <packet-cable-config>

```

```

    <packet-cable-enabled>true</packet-cable-enabled>
    <pcmm-enabled>true</pcmm-enabled>
    <pc-t0-timer>30</pc-t0-timer>
    <pc-t1-timer>200</pc-t1-timer>
    <pc-t7-timer>200</pc-t7-timer>
    <pc-t8-timer>0</pc-t8-timer>
    <pcmm-t1-timer>200</pcmm-t1-timer>
    <cmts-gate-id-value>47</cmts-gate-id-value>
    <tos>-1</tos>
    <cops-connection-threshold>4000</cops-connection-threshold>
    <control-point-discovery-enabled>true</control-point-discovery-enabled>
  </packet-cable-config>
  <pc-event-config>
    <retry-timer>4000</retry-timer>
    <retry-limit>3</retry-limit>
    <batch-size>5</batch-size>
    <max-age>5</max-age>
    <billing-events>true</billing-events>
  </pc-event-config>
</docs-packet-cable>
<docs-dsg>
  <dsg-timer-config>
    <timer-config-index>1</timer-config-index>
    <init-t-dsg-1>2</init-t-dsg-1>
    <oper-t-dsg-2>600</oper-t-dsg-2>
    <two-way-t-dsg-3>300</two-way-t-dsg-3>
    <one-way-t-dsg-4>1800</one-way-t-dsg-4>
  </dsg-timer-config>
  <dsg-downstream>
    <dsg-downstream-index>7</dsg-downstream-index>
    <enable-dcd>true</enable-dcd>
    <docsis-down-channel-ref>
      <slot>1</slot>
      <ds-rf-port>0</ds-rf-port>
      <down-channel>18</down-channel>
    </docsis-down-channel-ref>
    <timer-config-index>1</timer-config-index>
    <vendor-param-id>1</vendor-param-id>
    <dsg-channel-list-index>44</dsg-channel-list-index>
  </dsg-downstream>
  <dsg-downstream>
    <dsg-downstream-index>8</dsg-downstream-index>
    <enable-dcd>true</enable-dcd>
    <docsis-down-channel-ref>
      <slot>1</slot>
      <ds-rf-port>0</ds-rf-port>
      <down-channel>17</down-channel>
    </docsis-down-channel-ref>
    <timer-config-index>1</timer-config-index>
    <vendor-param-id>2</vendor-param-id>
    <dsg-channel-list-index>44</dsg-channel-list-index>
  </dsg-downstream>
  <dsg-downstream>
    <dsg-downstream-index>9</dsg-downstream-index>
    <enable-dcd>true</enable-dcd>
    <docsis-down-channel-ref>
      <slot>1</slot>
      <ds-rf-port>0</ds-rf-port>
      <down-channel>32</down-channel>
    </docsis-down-channel-ref>
    <timer-config-index>0</timer-config-index>
    <vendor-param-id>0</vendor-param-id>
    <dsg-channel-list-index>44</dsg-channel-list-index>
  </dsg-downstream>
  <dsg-channel-list>
    <dsg-channel-list-index>44</dsg-channel-list-index>
    <dsg-channel>
      <dsg-channel-index>1</dsg-channel-index>
      <channel-downstream-frequency>651000000</channel-downstream-frequency>
    </dsg-channel>
  </dsg-channel-list>

```



```

    <dsg-channel-index>2</dsg-channel-index>
    <channel-downstream-frequency>657000000</channel-downstream-frequency>
  </dsg-channel>
</dsg-channel-list>
<tunnel-group-to-channel-list>
  <tunnel-group-index>100</tunnel-group-index>
  <tunnel-group-channel>
    <tunnel-group-channel-index>1</tunnel-group-channel-index>
    <rule-priority>0</rule-priority>
    <vendor-param-id>2</vendor-param-id>
    <dsg-downstream-index>7</dsg-downstream-index>
  </tunnel-group-channel>
  <tunnel-group-channel>
    <tunnel-group-channel-index>2</tunnel-group-channel-index>
    <rule-priority>1</rule-priority>
    <vendor-param-id>2</vendor-param-id>
    <dsg-downstream-index>8</dsg-downstream-index>
  </tunnel-group-channel>
</tunnel-group-to-channel-list>
<dsg-tunnel-config>
  <dsg-tunnel-config-index>1</dsg-tunnel-config-index>
  <tunnel-grp-index>100</tunnel-grp-index>
  <mac-address>00:00:00:00:00:00</mac-address>
  <client-id-list-index>1</client-id-list-index>
  <service-class-name>ServiceClass1</service-class-name>
</dsg-tunnel-config>
<dsg-tunnel-config>
  <dsg-tunnel-config-index>2</dsg-tunnel-config-index>
  <tunnel-grp-index>100</tunnel-grp-index>
  <mac-address>00:00:00:00:00:01</mac-address>
  <client-id-list-index>2</client-id-list-index>
  <service-class-name>ServiceClass1</service-class-name>
</dsg-tunnel-config>
<dsg-classifier>
  <dsg-classifier-id>1</dsg-classifier-id>
  <tunnel-index>1</tunnel-index>
  <priority>0</priority>
  <source-ip>10.10.10.11/32</source-ip>
  <destination-ip>231.10.10.11</destination-ip>
  <destination-port-start>0</destination-port-start>
  <destination-port-end>65535</destination-port-end>
  <include-in-dcd>true</include-in-dcd>
</dsg-classifier>
<dsg-classifier>
  <dsg-classifier-id>2</dsg-classifier-id>
  <tunnel-index>1</tunnel-index>
  <priority>1</priority>
  <source-ip>10.10.10.10/32</source-ip>
  <destination-ip>231.10.10.10</destination-ip>
  <destination-port-start>0</destination-port-start>
  <destination-port-end>65535</destination-port-end>
  <include-in-dcd>true</include-in-dcd>
</dsg-classifier>
<dsg-classifier>
  <dsg-classifier-id>3</dsg-classifier-id>
  <tunnel-index>2</tunnel-index>
  <priority>0</priority>
  <source-ip>10.10.10.10/32</source-ip>
  <destination-ip>231.20.20.20</destination-ip>
  <destination-port-start>0</destination-port-start>
  <destination-port-end>65535</destination-port-end>
  <include-in-dcd>true</include-in-dcd>
</dsg-classifier>
<vendor-parameters-list>
  <vendor-param-id>1</vendor-param-id>
  <vendor-param>
    <vendor-index>1</vendor-index>
    <vendor-oui>010203</vendor-oui>
    <vendor-value>0102030405060708090a0b</vendor-value>
  </vendor-param>
</vendor-parameters-list>

```

```

    <vendor-index>2</vendor-index>
    <vendor-oui>010203</vendor-oui>
    <vendor-value>0f0e0d0c0b0a</vendor-value>
  </vendor-param>
</vendor-parameters-list>
<vendor-parameters-list>
  <vendor-param-id>2</vendor-param-id>
  <vendor-param>
    <vendor-index>1</vendor-index>
    <vendor-oui>040506</vendor-oui>
    <vendor-value>112233445566778899</vendor-value>
  </vendor-param>
</vendor-parameters-list>
<client-id-config-list>
<client-id-list-index>1</client-id-list-index>
  <dsg-client>
    <client-id-index>1</client-id-index>
    <dsg-client-id-type>broadcast</dsg-client-id-type>
    <client-id-value>000000000005</client-id-value>
    <vendor-parameters-id>1</vendor-parameters-id>
  </dsg-client>
  <dsg-client>
    <client-id-index>2</client-id-index>
    <dsg-client-id-type>mac-address</dsg-client-id-type>
    <client-id-value>010203040506</client-id-value>
  </dsg-client>
</client-id-config-list>
<client-id-config-list>
  <client-id-list-index>2</client-id-list-index>
  <dsg-client>
    <client-id-index>1</client-id-index>
    <dsg-client-id-type>application-id</dsg-client-id-type>
    <client-id-value>000000000800</client-id-value>
  </dsg-client>
</client-id-config-list>
</docs-dsg>
<docs-load-balancing>
  <load-balancing-policy>
    <policy-id>1</policy-id>
    <load-balance-rule>
      <rule-id>2</rule-id>
    </load-balance-rule>
  </load-balancing-policy>
  <basic-rule>
    <rule-id>2</rule-id>
    <enable>enabled</enable>
  </basic-rule>
  <general-grp-cfg>
    <mac-domain-name>MacDomain1</mac-domain-name>
    <fiber-node>
      <fiber-node-index>10</fiber-node-index>
    </fiber-node>
    <fiber-node>
      <fiber-node-index>16</fiber-node-index>
    </fiber-node>
    <policy-id>1</policy-id>
  </general-grp-cfg>
  <restricted-grp-cfg>
    <res-grp-id>100</res-grp-id>
    <grp-mac-domain>
      <mac-domain-name>MacDomain1</mac-domain-name>
    </grp-mac-domain>
    <init-tech>reinit-mac</init-tech>
    <policy-id>1</policy-id>
    <upstream-logical-channel-ref>
      <slot>9</slot>
      <us-rf-port>0</us-rf-port>
      <upstream-physical-channel>1</upstream-physical-channel>
      <upstream-logical-channel>0</upstream-logical-channel>
    </upstream-logical-channel-ref>
    <upstream-logical-channel-ref>

```

```

        <slot>9</slot>
        <us-rf-port>0</us-rf-port>
        <upstream-physical-channel>0</upstream-physical-channel>
        <upstream-logical-channel>0</upstream-logical-channel>
    </upstream-logical-channel-ref>
    <docsis-down-channel-ref>
        <slot>1</slot>
        <ds-rf-port>0</ds-rf-port>
        <down-channel>17</down-channel>
    </docsis-down-channel-ref>
    <docsis-down-channel-ref>
        <slot>1</slot>
        <ds-rf-port>0</ds-rf-port>
        <down-channel>18</down-channel>
    </docsis-down-channel-ref>
</restricted-grp-cfg>
</docs-load-balancing>
<ofdma-template>
    <ofdma-template-index>0</ofdma-template-index>
    <ofdma-template-name>Default OFDMA template</ofdma-template-name>
    <subcarrier-spacing>50khz</subcarrier-spacing>
    <ofdma-cyclic-prefix>288</ofdma-cyclic-prefix>
    <roll-off-period>160</roll-off-period>
    <symbols-per-frame>10</symbols-per-frame>
    <initial-ranging-iuc>
        <guard-band>400000</guard-band>
        <num-subcarriers>80</num-subcarriers>
    </initial-ranging-iuc>
    <fine-ranging-iuc>
        <guard-band>300000</guard-band>
        <num-subcarriers>220</num-subcarriers>
    </fine-ranging-iuc>
    <data-iuc>
        <data-iuc-index>5</data-iuc-index>
        <def-modulation>qam256</def-modulation>
        <def-pilot-pattern>12</def-pilot-pattern>
    </data-iuc>
    <data-iuc>
        <data-iuc-index>13</data-iuc-index>
        <def-modulation>qam64</def-modulation>
        <def-pilot-pattern>10</def-pilot-pattern>
    </data-iuc>
</ofdma-template>
</docsis>
<video>
    <global-input-ts-config>
        <jitter-tolerance>100</jitter-tolerance>
        <unicast-session-loss-timeout>5000</unicast-session-loss-timeout>
        <multicast-session-loss-timeout>5000</multicast-session-loss-timeout>
    </global-input-ts-config>
    <global-output-ts-config>
        <cat-insert-rate>10</cat-insert-rate>
        <pat-insert-rate>10</pat-insert-rate>
        <pmt-insert-rate>10</pmt-insert-rate>
    </global-output-ts-config>
    <video-input-ts>
        <input-ts-index>1</input-ts-index>
        <input-ts-name>CNN</input-ts-name>
        <multicast-video-input-ts>
            <multicast-ts>
                <multicast-ts-source-ip-address>10.0.0.9</multicast-ts-source-ip-address>
                <multicast-ts-destination-ip-address>232.100.0.0</multicast-ts-destination-ip-address>
                <multicast-ts-priority>127</multicast-ts-priority>
            </multicast-ts>
        </multicast-video-input-ts>
    </video-input-ts>
    <video-input-ts>
        <input-ts-index>2</input-ts-index>
        <input-ts-name>ABC</input-ts-name>
        <input-ts-decryption-enabled>true</input-ts-decryption-enabled>
        <multicast-video-input-ts>

```

```

    <multicast-ts>
      <multicast-ts-source-ip-address>10.0.0.9</multicast-ts-source-ip-address>
      <multicast-ts-destination-ip-address>232.100.0.1</multicast-ts-destination-ip-address>
      <multicast-ts-priority>127</multicast-ts-priority>
    </multicast-ts>
  </multicast-video-input-ts>
</video-input-ts>
<video-input-ts>
  <input-ts-index>3</input-ts-index>
  <input-ts-name>Music </input-ts-name>
  <input-ts-decryption-enabled>true</input-ts-decryption-enabled>
  <multicast-video-input-ts>
    <multicast-ts>
      <multicast-ts-source-ip-address>10.0.0.9</multicast-ts-source-ip-address>
      <multicast-ts-destination-ip-address>232.100.1.1</multicast-ts-destination-ip-address>
      <multicast-ts-destination-udp-port>2000</multicast-ts-destination-udp-port>
      <multicast-ts-priority>100</multicast-ts-priority>
    </multicast-ts>
    <multicast-ts>
      <multicast-ts-source-ip-address>10.0.0.10</multicast-ts-source-ip-address>
      <multicast-ts-destination-ip-address>232.100.1.1</multicast-ts-destination-ip-address>
      <multicast-ts-destination-udp-port>2000</multicast-ts-destination-udp-port>
      <multicast-ts-priority>50</multicast-ts-priority>
    </multicast-ts>
  </multicast-video-input-ts>
</video-input-ts>
<video-input-ts>
  <input-ts-index>4</input-ts-index>
  <input-ts-name>HBO</input-ts-name>
  <multicast-video-input-ts>
    <multicast-ts>
      <multicast-ts-source-ip-address>10.0.0.9</multicast-ts-source-ip-address>
      <multicast-ts-destination-ip-address>232.100.1.100</multicast-ts-destination-ip-
address>
      <multicast-ts-destination-udp-port>2000</multicast-ts-destination-udp-port>
      <multicast-ts-priority>100</multicast-ts-priority>
    </multicast-ts>
    <multicast-ts>
      <multicast-ts-source-ip-address>10.0.0.10</multicast-ts-source-ip-address>
      <multicast-ts-destination-ip-address>232.100.1.100</multicast-ts-destination-ip-
address>
      <multicast-ts-destination-udp-port>2000</multicast-ts-destination-udp-port>
      <multicast-ts-priority>100</multicast-ts-priority>
    </multicast-ts>
  </multicast-video-input-ts>
</video-input-ts>
<video-input-ts>
  <input-ts-index>5</input-ts-index>
  <unicast-video-input-ts>
    <address>
      <unicast-ts-destination-ip-address>10.10.10.99</unicast-ts-destination-ip-
address>
    </address>
    <unicast-ts-destination-udp-port>2000</unicast-ts-destination-udp-port>
  </unicast-video-input-ts>
</video-input-ts>
<video-input-ts>
  <input-ts-index>6</input-ts-index>
  <unicast-video-input-ts>
    <interface>
      <unicast-ts-interface-name>eth6/0</unicast-ts-interface-name>
    </interface>
    <unicast-ts-destination-udp-port>3000</unicast-ts-destination-udp-port>
  </unicast-video-input-ts>
</video-input-ts>
<static-udp-map>
  <udp-map-index>0</udp-map-index>
  <starting-udp-port>5000</starting-udp-port>
  <port-count>10</port-count>
  <static-video-output-ts>0</static-video-output-ts>
</static-udp-map>

```

```

<static-udp-map>
  <udp-map-index>1</udp-map-index>
  <starting-udp-port>5010</starting-udp-port>
  <port-count>10</port-count>
  <static-video-output-ts>1</static-video-output-ts>
</static-udp-map>
<reserved-udp-map>
  <udp-map-index>0</udp-map-index>
  <starting-udp-port>0</starting-udp-port>
  <port-count>1024</port-count>
</reserved-udp-map>
<reserved-pid-range>
  <reserved-pid-range-index>0</reserved-pid-range-index>
  <starting-pid>0</starting-pid>
  <count>32</count>
  <description>MPEG-2 and DVB reserved</description>
</reserved-pid-range>
<reserved-pid-range>
  <reserved-pid-range-index>1</reserved-pid-range-index>
  <starting-pid>32</starting-pid>
  <count>224</count>
  <description>Reserved for non-remapped pid session</description>
</reserved-pid-range>
<reserved-pid-range>
  <reserved-pid-range-index>2</reserved-pid-range-index>
  <starting-pid>8187</starting-pid>
  <count>5</count>
  <description>MPEG-2 and ATSC reserved</description>
</reserved-pid-range>
<input-registration>
  <input-registration-name>eth6/0</input-registration-name>
  <group-name>EDGE-IN-GROUP-1</group-name>
  <erm-name>ERM-1</erm-name>
  <bandwidth>0</bandwidth>
  <erm-managed-input>true</erm-managed-input>
</input-registration>
<input-registration>
  <input-registration-name>eth6/3a</input-registration-name>
  <group-name>GROUP-1A</group-name>
  <erm-name>ERM-1</erm-name>
  <bandwidth>1000000</bandwidth>
  <erm-managed-input>true</erm-managed-input>
</input-registration>
<input-registration>
  <input-registration-name>eth6/3b</input-registration-name>
  <group-name>GROUP-1B</group-name>
  <erm-name>ERM-1</erm-name>
  <bandwidth>1000000</bandwidth>
  <erm-managed-input>true</erm-managed-input>
</input-registration>
<input-registration>
  <input-registration-name>eth7/0</input-registration-name>
  <group-name>EDGE-IN-GROUP-1</group-name>
  <erm-name>ERM-1</erm-name>
  <bandwidth>0</bandwidth>
  <erm-managed-input>true</erm-managed-input>
</input-registration>
<input-registration>
  <input-registration-name>eth7/6</input-registration-name>
  <group-name>GROUP-2A</group-name>
  <erm-name>ERM-2</erm-name>
  <bandwidth>1000000</bandwidth>
  <erm-managed-input>true</erm-managed-input>
</input-registration>
<pid-session>
  <session-index>100</session-index>
  <session-name>HBO</session-name>
  <session-input-ts>4</session-input-ts>
  <session-output-ts>
    <session-output-ts-index>0</session-output-ts-index>
  </session-output-ts>

```

```

    <input-pid>100</input-pid>
    <pid-remap-enable>>false</pid-remap-enable>
    <pid-type>pat</pid-type>
    <cas-id>00000000</cas-id>
    <output-pid>1100</output-pid>
  </pid-session>
  <pid-session>
    <session-index>92</session-index>
    <session-input-ts>5</session-input-ts>
    <session-output-ts>
      <session-output-ts-index>0</session-output-ts-index>
    </session-output-ts>
    <input-pid>92</input-pid>
    <pid-remap-enable>>false</pid-remap-enable>
    <pid-type>pat</pid-type>
    <cas-id>00000000</cas-id>
    <output-pid>1092</output-pid>
  </pid-session>
  <program-session>
    <session-index>0</session-index>
    <session-name>CNN-HD</session-name>
    <session-input-ts>1</session-input-ts>
    <session-output-ts>
      <session-output-ts-index>0</session-output-ts-index>
    </session-output-ts>
    <input-mpeg-program-number>8</input-mpeg-program-number>
    <output-mpeg-program-number>4</output-mpeg-program-number>
    <pat-pid-remap>>true</pat-pid-remap>
    <requested-bandwidth>12000000</requested-bandwidth>
    <cas-info>0</cas-info>
    <encryption-data>0</encryption-data>
    <encrypt-control>0</encrypt-control>
  </program-session>
  <program-session>
    <session-index>1</session-index>
    <session-name>ABC-HD</session-name>
    <session-input-ts>2</session-input-ts>
    <session-output-ts>
      <session-output-ts-index>0</session-output-ts-index>
    </session-output-ts>
    <input-mpeg-program-number>3</input-mpeg-program-number>
    <output-mpeg-program-number>7</output-mpeg-program-number>
    <pat-pid-remap>>true</pat-pid-remap>
    <requested-bandwidth>12000000</requested-bandwidth>
    <cas-info>0</cas-info>
    <encryption-data>1</encryption-data>
    <encrypt-control>0</encrypt-control>
  </program-session>
  <cas-info>
    <cas-info-index>0</cas-info-index>
    <cas-id>00000000</cas-id>
    <ca-blob>String</ca-blob>
  </cas-info>
  <mpts-passthrough-session>
    <session-index>0</session-index>
    <session-name>Music-channels</session-name>
    <session-input-ts>3</session-input-ts>
    <session-output-ts>
      <session-output-ts-index>1</session-output-ts-index>
    </session-output-ts>
  </mpts-passthrough-session>
  <encryption-data>
    <encryption-data-index>0</encryption-data-index>
    <cci-level>copy-never</cci-level>
    <cit>clear</cit>
    <rct>not-asserted</rct>
    <cci-reserved>0</cci-reserved>
    <provider-asset-id>67343-CNN-HD</provider-asset-id>
  </encryption-data>
  <encryption-data>
    <encryption-data-index>1</encryption-data-index>

```

```

    <cci-level>copy-never</cci-level>
    <cit>set</cit>
    <rct>required</rct>
    <cci-reserved>0</cci-reserved>
    <provider-asset-id>89643-ABC-HD</provider-asset-id>
  </encryption-data>
  <encrypt-control>
    <encrypt-control-index>0</encrypt-control-index>
    <encryption-scheme>dvbcsa</encryption-scheme>
    <block-stream-until-encrypted>true</block-stream-until-encrypted>
    <key-length>128bits</key-length>
    <encryptor-opaque>CA-KEY-0957723545635</encryptor-opaque>
  </encrypt-control>
  <ecmd>
    <ecm-index>1</ecm-index>
    <ecm-server>
      <address>
        <address>10.0.0.1</address>
      </address>
    </ecm-server>
    <ecm-server-port>65535</ecm-server-port>
    <ecm-cas-id>00000001</ecm-cas-id>
    <number-decrypted-streams>128</number-decrypted-streams>
  </ecmd>
  <ecmg>
    <ecm-index>1</ecm-index>
    <ecm-server>
      <address>
        <address>10.0.0.1</address>
      </address>
    </ecm-server>
    <ecm-server-port>65535</ecm-server-port>
    <ecm-cas-id>00000001</ecm-cas-id>
    <recommended-cp-duration>5</recommended-cp-duration>
    <number-encrypted-streams>128</number-encrypted-streams>
  </ecmg>
  <erm-registration>
    <erm-name>ERM-1</erm-name>
    <erm-address>
      <address>
        <address>192.168.0.45</address>
      </address>
    </erm-address>
    <erm-port>6069</erm-port>
    <erm-connection-mode>server</erm-connection-mode>
    <hold-timer>240</hold-timer>
    <connection-retry-timer>120</connection-retry-timer>
    <next-hop-address-domain>0</next-hop-address-domain>
    <comp-address>
      <name>
        <name>google.com</name>
      </name>
    </comp-address>
    <streaming-zone>Zone1</streaming-zone>
    <id>0</id>
    <cost>0</cost>
    <comp-name>Region1,Local2</comp-name>
  </erm-registration>
  <video-output-ts>
    <output-ts-index>0</output-ts-index>
    <output-ts-name>SDV1</output-ts-name>
    <video-down-channel-ref>
      <slot>1</slot>
      <ds-rf-port>0</ds-rf-port>
      <down-channel>1</down-channel>
    </video-down-channel-ref>
    <video-down-channel-ref>
      <slot>1</slot>
      <ds-rf-port>1</ds-rf-port>
      <down-channel>1</down-channel>
    </video-down-channel-ref>

```

```

    <video-down-channel-ref>
      <slot>3</slot>
      <ds-rf-port>0</ds-rf-port>
      <down-channel>1</down-channel>
    </video-down-channel-ref>
    <video-down-channel-ref>
      <slot>3</slot>
      <ds-rf-port>1</ds-rf-port>
      <down-channel>1</down-channel>
    </video-down-channel-ref>
  </video-output-ts>
<video-output-ts>
  <output-ts-index>1</output-ts-index>
  <output-ts-name>Music Channels</output-ts-name>
  <video-down-channel-ref>
    <slot>1</slot>
    <ds-rf-port>0</ds-rf-port>
    <down-channel>2</down-channel>
  </video-down-channel-ref>
  <video-down-channel-ref>
    <slot>1</slot>
    <ds-rf-port>1</ds-rf-port>
    <down-channel>2</down-channel>
  </video-down-channel-ref>
  <video-down-channel-ref>
    <slot>3</slot>
    <ds-rf-port>0</ds-rf-port>
    <down-channel>2</down-channel>
  </video-down-channel-ref>
  <video-down-channel-ref>
    <slot>3</slot>
    <ds-rf-port>1</ds-rf-port>
    <down-channel>2</down-channel>
  </video-down-channel-ref>
</video-output-ts>
<static-udp-map-encryption>
  <udp-map-encryption-index>2</udp-map-encryption-index>
  <cas-info>0</cas-info>
  <encryption-data>0</encryption-data>
  <encrypt-control>1</encrypt-control>
</static-udp-map-encryption>
</video>
<epon>
  <oam-config>
    <min-oam-rate>1</min-oam-rate>
    <max-oam-rate>30</max-oam-rate>
    <oam-response-timeout>1</oam-response-timeout>
  </oam-config>
  <loop-timing-config>
    <min-propagation-delay>0</min-propagation-delay>
    <max-propagation-delay>6250</max-propagation-delay>
    <onu-delay>3125</onu-delay>
  </loop-timing-config>
  <mcp-config>
    <discovery-period>700</discovery-period>
    <grant-size-in-discovery-gate>16319</grant-size-in-discovery-gate>
    <deregistration-timeout>0</deregistration-timeout>
  </mcp-config>
  <deny-onu>
    <onu-mac-address>00:63:44:00:11:29</onu-mac-address>
  </deny-onu>
</epon>
<network>
  <dns-resolver>
    <domain-suffix>example.com</domain-suffix>
    <enabled>true</enabled>
  </dns-resolver>
  <dns-server>
    <dns-server-index>1</dns-server-index>
    <server-ip>10.10.10.10</server-ip>
  </dns-server>

```



```
<integrated-servers>
  <server-type>ssh</server-type>
  <local-listener-port>22</local-listener-port>
  <enabled>true</enabled>
  <listener-ip-interface-name>eth0</listener-ip-interface-name>
</integrated-servers>
<authentication-policy>
  <policy>login</policy>
  <protocol>radius</protocol>
  <priority>2</priority>
</authentication-policy>
<local-authorization>
  <username>admin</username>
  <privilege-level>2</privilege-level>
  <password>root</password>
  <clear-key>true</clear-key>
</local-authorization>
<radius>
  <auth-server-index>1</auth-server-index>
  <auth-server>
    <address>
      <address>10.10.10.10</address>
    </address>
  </auth-server>
  <auth-key>testing</auth-key>
  <auth-clear-key>true</auth-clear-key>
  <auth-timeout>3</auth-timeout>
  <auth-retransmit-attempts>1</auth-retransmit-attempts>
  <primary-auth-server>true</primary-auth-server>
  <source-ip-interface-name>eth0</source-ip-interface-name>
  <radius-auth-port>1812</radius-auth-port>
  <accounting-port>1813</accounting-port>
</radius>
<tacacs-plus>
  <auth-server-index>1</auth-server-index>
  <auth-server>
    <address>
      <address>10.10.10.10</address>
    </address>
  </auth-server>
  <auth-key>testing</auth-key>
  <auth-clear-key>true</auth-clear-key>
  <auth-timeout>3</auth-timeout>
  <auth-retransmit-attempts>1</auth-retransmit-attempts>
  <primary-auth-server>true</primary-auth-server>
  <source-ip-interface-name>eth0</source-ip-interface-name>
  <tacacs-plus-auth-port>49</tacacs-plus-auth-port>
</tacacs-plus>
<keychain>
  <key-id>1</key-id>
  <key-string>testing</key-string>
  <accept-lifetime>1000</accept-lifetime>
  <send-lifetime>10000</send-lifetime>
  <clear-key>true</clear-key>
</keychain>
<fail-over>
  <auto-fail-back>true</auto-fail-back>
</fail-over>
<local-time>
  <ntp-master>
    <name>
      <name>time.nist.gov</name>
    </name>
  </ntp-master>
  <time-zone>-07</time-zone>
  <dst-recurring-change>true</dst-recurring-change>
  <source-ip-interface-name>eth0</source-ip-interface-name>
</local-time>
<acl>
  <acl-name>acl1</acl-name>
  <ip-acl-rule>
```

```

    <acl-rule-index>1</acl-rule-index>
    <is-rule>
      <acl-action>accept</acl-action>
      <ipv4>
        <ipv4-rule>
          <dest-ipv4-addr-filter>
            <dest-addr>10.30.50.0</dest-addr>
            <dest-wildcard-mask>0.0.0.255</dest-wildcard-mask>
          </dest-ipv4-addr-filter>
        </ipv4-rule>
      </ipv4>
    </is-rule>
  </ip-acl-rule>
</ip-acl-rule>
<ip-acl-rule>
  <acl-rule-index>2</acl-rule-index>
  <is-rule>
    <acl-action>accept</acl-action>
    <ipv4>
      <ipv4-rule>
        <source-ipv4-addr-filter>
          <source-addr>66.77.88.100</source-addr>
          <source-wildcard-mask>0.0.0.0</source-wildcard-mask>
        </source-ipv4-addr-filter>
        <single-source-port>
          <sport>1024</sport>
          <sport-comparator>lt</sport-comparator>
        </single-source-port>
      </ipv4-rule>
    </ipv4>
  </is-rule>
</ip-acl-rule>
</acl>
<acl>
  <acl-name>acl2</acl-name>
  <ip-acl-rule>
    <acl-rule-index>1</acl-rule-index>
    <is-rule>
      <acl-action>accept</acl-action>
      <ipv6>
        <ipv6-rule>
          <dest-ipv6-addr-filter>
            <dest-addr>fc00:0:c416:c015::</dest-addr>
            <dest-wildcard-
mask>0000:ffff:0000:0000:ffff:ffff:ffff:ffff</dest-wildcard-mask>
          </dest-ipv6-addr-filter>
          <protocol-value>
            <protocol-id>6</protocol-id>
          </protocol-value>
          <dest-portrange>
            <start-dport>10000</start-dport>
            <end-dport>10100</end-dport>
          </dest-portrange>
        </ipv6-rule>
      </ipv6>
    </is-rule>
  </ip-acl-rule>
  <ip-acl-rule>
    <acl-rule-index>2</acl-rule-index>
    <is-remark>
      <remark>IPv6 rule</remark>
    </is-remark>
  </ip-acl-rule>
  <ip-acl-rule>
    <acl-rule-index>3</acl-rule-index>
    <is-rule>
      <acl-action>deny</acl-action>
      <ipv6></ipv6>
    </is-rule>
  </ip-acl-rule>
</acl>
</network>

```

```

<interface>
  <cable-bundle>
    <interface-index>1</interface-index>
    <admin-state>up</admin-state>
    <ip-interface>
      <ip-interface-name>mac1</ip-interface-name>
      <primary-ipv4>
        <ip-address>192.168.11.7/10</ip-address>
      </primary-ipv4>
      <ipv6>
        <ipv6-address>fe80:0:230:48ff:fe23:4177/10</ipv6-address>
      </ipv6>
      <secondary-ipv4>
        <ip-address>192.168.11.12/10</ip-address>
      </secondary-ipv4>
    </ip-interface>
    <dhcp-giaddr-primary>192.168.11.7</dhcp-giaddr-primary>
    <secondary-giaddr>
      <dhcp-giaddr-secondary>192.168.11.12</dhcp-giaddr-secondary>
    </secondary-giaddr>
    <docs-md>
      <docsis-mac-domain>
        <docsis-mac-domain-name>MacDomain1</docsis-mac-domain-name>
      </docsis-mac-domain>
    </docs-md>
    <cable-helper-config>
      <cable-helper-config-index>1</cable-helper-config-index>
      <cable-helper-address>
        <address>
          <address>192.168.11.1</address>
        </address>
      </cable-helper-address>
      <application>all</application>
    </cable-helper-config>
    <ingress-acl>acl2</ingress-acl>
    <egress-acl>acl1</egress-acl>
  </cable-bundle>
  <loopback>
    <interface-index>1</interface-index>
    <admin-state>up</admin-state>
    <ip-interface>
      <ip-interface-name>lo</ip-interface-name>
      <primary-ipv4>
        <ip-address>127.0.0.1/32</ip-address>
      </primary-ipv4>
      <ipv6>
        <ipv6-address>fe80:0:230:48ff:fe23:4177/10</ipv6-address>
      </ipv6>
      <secondary-ipv4>
        <ip-address>127.0.0.1/10</ip-address>
      </secondary-ipv4>
    </ip-interface>
  </loopback>
  <mgmd-router-interface>
    <query-interval>125</query-interval>
    <version>igmp-v2-or-mld-v1</version>
    <query-max-response-time>100</query-max-response-time>
    <robustness>4</robustness>
    <last-member-query-interval>25</last-member-query-interval>
  </mgmd-router-interface>
</interface>
<management>
  <ipdr>
    <exporter-config>
      <enabled>true</enabled>
    </exporter-config>
    <streaming-session>
      <session-id>1</session-id>
      <keep-alive-interval>20</keep-alive-interval>
      <ack-time-interval>30</ack-time-interval>
      <ack-sequence-interval>200</ack-sequence-interval>
    </streaming-session>
  </ipdr>

```

```

    <collection-interval>15</collection-interval>
    <streaming-type>time-interval</streaming-type>
    <enabled>true</enabled>
    <service-definition-template>
      <service-definition-id>samis-type-2</service-definition-id>
    </service-definition-template>
    <service-definition-template>
      <service-definition-id>cpe-type</service-definition-id>
    </service-definition-template>
    <collector-reference>
      <collector-id>1</collector-id>
    </collector-reference>
  </streaming-session>
</collector>
<collector>
  <collector-id>1</collector-id>
  <collector-ip>10.10.10.10</collector-ip>
  <collector-name>Collector1</collector-name>
  <collector-port>4737</collector-port>
  <priority>1</priority>
</collector>
</ipdr>
<fault-management>
  <event-throttle-config>
    <throttle-admin-state>unconstrained</throttle-admin-state>
    <threshold>50</threshold>
    <interval>1</interval>
  </event-throttle-config>
  <event-reporting-config>
    <priority>emergency</priority>
    <reporting>local traps syslog</reporting>
  </event-reporting-config>
  <event-reporting-config>
    <priority>alert</priority>
    <reporting>local traps syslog</reporting>
  </event-reporting-config>
  <event-reporting-config>
    <priority>critical</priority>
    <reporting>local traps syslog</reporting>
  </event-reporting-config>
  <event-reporting-config>
    <priority>error</priority>
    <reporting>local syslog</reporting>
  </event-reporting-config>
  <event-reporting-config>
    <priority>warning</priority>
    <reporting>local syslog</reporting>
  </event-reporting-config>
  <event-reporting-config>
    <priority>notice</priority>
    <reporting>local syslog</reporting>
  </event-reporting-config>
  <event-reporting-config>
    <priority>information</priority>
    <reporting>local</reporting>
  </event-reporting-config>
  <event-reporting-config>
    <priority>debug</priority>
    <reporting>local</reporting>
  </event-reporting-config>
  <cmts-event-ctrl>
    <event-id>0</event-id>
  </cmts-event-ctrl>
  <trap-enable>
    <snmp-enable-authen-traps>true</snmp-enable-authen-traps>
  </trap-enable>
  <interface-trap-enable>
    <if-name>IF-1/1</if-name>
    <link-up-down-trap-enable>true</link-up-down-trap-enable>
  </interface-trap-enable>
  <interface-trap-enable>
    <if-name>IF-1/2</if-name>

```

```

    <link-up-down-trap-enable>>false</link-up-down-trap-enable>
  </interface-trap-enable>
  <syslog-server-config>
    <syslog-server-config-index>0</syslog-server-config-index>
    <syslog-server>
      <address>
        <address>192.168.0.45</address>
      </address>
    </syslog-server>
    <enabled>>true</enabled>
  </syslog-server-config>
  <diag-log-triggers-config>
    <include-triggers>ranging-retry</include-triggers>
    <enable-aging-triggers>ranging-retry</enable-aging-triggers>
    <reg-time-interval>90</reg-time-interval>
    <reg-detail>config-file-download-complete</reg-detail>
    <ranging-retry-trigger>consecutive-miss</ranging-retry-trigger>
    <ranging-retry-threshold>6</ranging-retry-threshold>
    <ranging-retry-station-maint-num>90</ranging-retry-station-maint-num>
  </diag-log-triggers-config>
  <diag-log-global-config>
    <max-size>100</max-size>
    <notify-log-size-high-thrshld>80</notify-log-size-high-thrshld>
    <notify-log-size-low-thrshld>60</notify-log-size-low-thrshld>
    <aging>10080</aging>
    <notif-ctrl>high-threshold-reached</notif-ctrl>
  </diag-log-global-config>
</fault-management>
<snmp>
  <access-config>
    <community>public</community>
    <ip-address>192.168.0.20/24</ip-address>
    <type>read-only</type>
    <view-config-ref>
      <view-name>ALL-MIB</view-name>
    </view-config-ref>
  </access-config>
  <access-config>
    <community>public-v1</community>
    <ip-address>192.168.0.20/24</ip-address>
    <type>read-only</type>
    <view-config-ref>
      <view-name>ALL-MIB</view-name>
    </view-config-ref>
    <view-config-ref>
      <view-name>NO-V2MIB</view-name>
    </view-config-ref>
  </access-config>
  <access-config>
    <community>private</community>
    <ip-address>192.168.0.20/24</ip-address>
    <type>read-write</type>
    <view-config-ref>
      <view-name>ALL-MIB</view-name>
    </view-config-ref>
  </access-config>
  <view-config>
    <view-name>ALL-MIB</view-name>
    <subtree>1</subtree>
    <subtree-mask>0</subtree-mask>
    <type>included</type>
  </view-config>
  <view-config>
    <view-name>NO-V2MIB</view-name>
    <subtree>1.3.6.1.6</subtree>
    <subtree-mask>65535</subtree-mask>
    <type>excluded</type>
  </view-config>
  <notification-receiver-config>
    <notification-receiver-name>NMS-1</notification-receiver-name>
    <type>snmpv2c-inform</type>

```

```

<notification-receiver>
  <address>
    <address>192.168.0.89</address>
  </address>
</notification-receiver>
<notification-receiver-port>162</notification-receiver-port>
<timeout>1</timeout>
<retries>3</retries>
<view-config-ref>
  <view-name>ALL-MIB</view-name>
</view-config-ref>
</notification-receiver-config>
<notification-receiver-config>
  <notification-receiver-name>NMS-2</notification-receiver-name>
  <type>snmpv2c-inform</type>
  <notification-receiver>
    <name>
      <name>snmpHost.mso</name>
    </name>
  </notification-receiver>
  <notification-receiver-port>162</notification-receiver-port>
  <timeout>1</timeout>
  <retries>3</retries>
  <view-config-ref>
    <view-name>ALL-MIB</view-name>
  </view-config-ref>
  <view-config-ref>
    <view-name>NO-V2MIB</view-name>
  </view-config-ref>
</notification-receiver-config>
</snmp>
</management>
</ccap:ccap>

```

## I.2 CCAP Partial Configuration

See Section 6.3.5, XML Configuration File Execution Command and NETCONF Operations, for sample partial configuration XML files.

## I.3 Sample NETCONF Message Exchanges

The following sections show examples of how messages flow between a NETCONF client and the NETCONF server on the CCAP. In the first example, the changes are communicated, but the configuration is not locked. In the second example, the NETCONF client locks the configuration while the session is active. While the session is locked, other users are unable to make changes. If the CCAP is unable to "promote" the candidate configuration to running-config before the timeout period, the changes will be rolled back.

### I.3.1 Changes Made to running-config without Locks or Timeouts

In this example, changes are made directly to the running-config. No timeout is set, so the Client waits until the CCAP completes the configuration change.

NETCONF Client and the CCAP send <hello> messages and the CCAP advertises support for its supported version of NETCONF and of the CCAP configuration modules.

```

Client: <hello xmlns="urn:ietf:params:xml:ns:netconf:base:1.0">
Client: <capabilities>
Client: <capability>urn:ietf:params:netconf:base:1.0</capability>
Client: </capabilities>
Client: </hello>

CCAP: <hello xmlns="urn:ietf:params:xml:ns:netconf:base:1.0">
CCAP: <capabilities>
CCAP: <capability>
CCAP: urn:ietf:params:xml:ns:netconf:base:1.0
CCAP: </capability>

```

```

CCAP: <capability>
CCAP: urn:cablelabs:params:xml:ns:yang:ccap?revision=2012-08-09?module=ccap
CCAP: </capability>
CCAP: <session-id>101</session-id>
CCAP: </capabilities>
CCAP: </hello>

```

The client successfully updates the running-config with the updated name, description, and location parameters and EPON parameters. The change takes effect immediately.

```

Client: <rpc message-id="1"
Client  xmlns="urn:ietf:params:xml:ns:netconf:base:1.0">
Client: <edit-config>
Client: <target>
Client: <running/>
Client: </target>
Client: <config>
Client: <ccap xmlns="urn:cablelabs:params:xml:ns:yang:ccap">
Client: <epon>
Client: <oam-config>
Client: <min-oam-rate>2</min-oam-rate>
Client: <max-oam-rate>31</max-oam-rate>
Client: <oam-response-timeout>2</oam-response-timeout>
Client: </oam-config>
Client: <loop-timing-config>
Client: <min-propagation-delay>1</min-propagation-delay>
Client: <max-propagation-delay>6251</max-propagation-delay>
Client: <onu-delay>3126</onu-delay>
Client: </loop-timing-config>
Client: <mpcp-config>
Client: <discovery-period>1001</discovery-period>
Client: <grant-size-in-discovery-gate>16320</grant-size-in-discovery-gate>
Client: <deregistration-timeout>1</deregistration-timeout>
Client: </mpcp-config>
Client: </epon>
Client: </ccap>
Client: </config>
Client: </edit-config>
Client: </rpc>

CCAP: <rpc-reply message-id="1" xmlns="urn:ietf:params:xml:ns:netconf:base:1.0">
CCAP: <ok/>
CCAP: </rpc-reply>

```

The CCAP copies the running-config to the startup-config.

```

Client: <rpc message-id="2" xmlns="urn:ietf:params:xml:ns:netconf:base:1.0">
Client: <copy-config>
Client: <target>
Client: <startup/>
Client: </target>
Client: <source>
Client: </running>
Client: </source>
Client: </copy-config>
Client: </rpc>

CCAP: <rpc-reply message-id="2" xmlns="urn:ietf:params:xml:ns:netconf:base:1.0">
CCAP: <ok/>
CCAP: </rpc-reply>

```

The client then closes the session by sending the <close-session> operation.

```

Client: <rpc message-id="3" xmlns="urn:ietf:params:xml:ns:netconf:base:1.0">
Client: <close-session/>
Client: </rpc>

```

The CCAP acknowledges the request and the transport session is subsequently terminated.

```

CCAP: <rpc-reply message-id="3" xmlns="urn:ietf:params:xml:ns:netconf:base:1.0">
CCAP: <ok/>
CCAP: </rpc-reply>

```

### I.3.2 Changes Made to candidate-config with a Lock

In this example, the Client makes updates to a candidate-config, then instructs the CCAP to copy it to the running-config. If the CCAP is unable to complete this task by the timeout set, then the changes will be rolled back.

NETCONF Client and the CCAP send <hello> messages and the CCAP advertises support for its supported version of NETCONF and of the CCAP configuration modules.

```
Client: <hello xmlns="urn:ietf:params:xml:ns:netconf:base:1.0">
Client: <capabilities>
Client: <capability>urn:ietf:params:netconf:base:1.0</capability>
Client: </capabilities>
Client: </hello>

CCAP: <hello xmlns="urn:ietf:params:xml:ns:netconf:base:1.0">
CCAP: <capabilities>
CCAP: <capability>
CCAP: urn:ietf:params:xml:ns:netconf:base:1.0
CCAP: </capability>
CCAP: <capability>
CCAP: urn:cablelabs:params:xml:ns:yang:ccap?revision=2012-08-09?module=ccap
CCAP: </capability>
CCAP: <session-id>101</session-id>
CCAP: </capabilities>
CCAP: </hello>
```

Client takes a lock on the running datastore.

```
Client: <rpc xmlns="urn:ietf:params:xml:ns:netconf:base:1.0" message-id="1">
Client:   <lock>
Client:     <target>
Client:       <running/>
Client:     </target>
Client:   </lock>
Client: </rpc>

CCAP: <rpc-reply xmlns="urn:ietf:params:xml:ns:netconf:base:1.0" message-id="1">
CCAP:   <ok/>
CCAP: </rpc-reply>
```

The Client successfully updates the candidate-config with the changes to the CCAP parameters and EPON parameters.

```
Client: <rpc message-id="2" xmlns="urn:ietf:params:xml:ns:netconf:base:1.0">
Client: <edit-config>
Client: <target>
Client: <candidate/>
Client: </target>
Client: <config>
Client: <ccap xmlns="urn:cablelabs:params:xml:ns:yang:ccap">
Client: <epon>
Client: <oam-config>
Client: <min-oam-rate>2</min-oam-rate>
Client: <max-oam-rate>31</max-oam-rate>
Client: <oam-response-timeout>2</oam-response-timeout>
Client: </oam-config>
Client: <loop-timing-config>
Client: <min-propagation-delay>1</min-propagation-delay>
Client: <max-propagation-delay>6251</max-propagation-delay>
Client: <onu-delay>3126</onu-delay>
Client: </loop-timing-config>
Client: <mpcp-config>
Client: <discovery-period>1001</discovery-period>
Client: <grant-size-in-discovery-gate>16320</grant-size-in-discovery-gate>
Client: <deregistration-timeout>1</deregistration-timeout>
Client: </mpcp-config>
Client: </epon>
Client: </ccap>
Client: </config>
Client: </edit-config>
Client: </rpc>
```



```
CCAP: <rpc-reply xmlns="urn:ietf:params:xml:ns:netconf:base:1.0" message-id="2">
CCAP:   <ok/>
CCAP: </rpc-reply>
```

The Client commits the configuration in the candidate-config to the running-config. This is done with a timeout of 120 seconds. The CCAP is expected to come back with a confirming commit before the timeout expires, otherwise the configuration change will roll back.

```
Client: <rpc message-id="3" xmlns="urn:ietf:params:xml:ns:netconf:base:1.0">
Client:   <commit>
Client:     <confirmed/>
Client:     <confirm-timeout>120</confirm-timeout>
Client:   </commit>
Client: </rpc>

CCAP: <rpc-reply message-id="3" xmlns="urn:ietf:params:xml:ns:netconf:base:1.0">
CCAP:   <ok/>
CCAP: </rpc-reply>
```

The Client does any external tests required and then comes back with a confirming commit.

```
Client: <rpc message-id="4" xmlns="urn:ietf:params:xml:ns:netconf:base:1.0">
Client:   <commit/>
Client: </rpc>

CCAP: <rpc-reply message-id="4" xmlns="urn:ietf:params:xml:ns:netconf:base:1.0">
CCAP:   <ok/>
CCAP: </rpc-reply>
```

The Client releases the lock on the running data store allowing other applications to access the configuration.

```
Client: <rpc message-id="5" xmlns="urn:ietf:params:xml:ns:netconf:base:1.0">
Client:   <unlock>
Client:     <target>
Client:       <running/>
Client:     </target>
Client:   </unlock>
Client: </rpc>

CCAP: <rpc-reply message-id="5" xmlns="urn:ietf:params:xml:ns:netconf:base:1.0">
CCAP:   <ok/>
CCAP: </rpc-reply>
```

The Client then closes the session by sending the <close-session> operation.

```
Client: <rpc message-id="6" xmlns="urn:ietf:params:xml:ns:netconf:base:1.0">
Client:   <close-session/>
Client: </rpc>
```

The CCAP acknowledges the request and the transport session is subsequently terminated.

```
CCAP: <rpc-reply message-id="6" xmlns="urn:ietf:params:xml:ns:netconf:base:1.0">
CCAP:   <ok/>
CCAP: </rpc-reply>
```

## Appendix II Use Cases (Informative)

### II.1 Identifying Replicated QAMs

A replicated QAM can be identified by looking at the data presented in the SCTE-HMS-MPEG-MIB. In the mpegOutputTsTable the replicated QAM can be identified by locating instances that have the same mpegOutputTSTSID values. In the following example, QAM instance 100 and 137 are replicated - they both have an mpegOutputTSTSID of 1000.

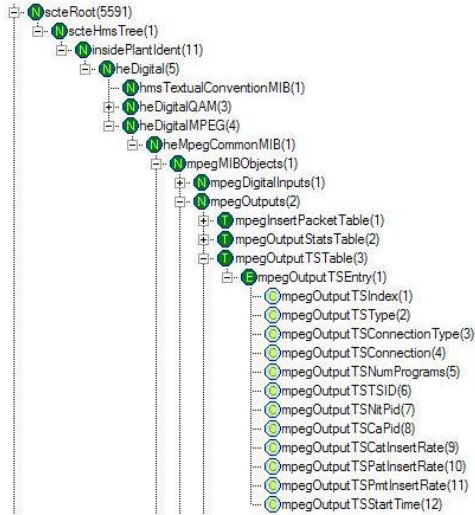

Instance	mpegOutputTsIndex	mpegOutputTsType	mpegOutputTsConnectionType	mpegOutputTsConnection	mpegOutputTsNumPrograms	mpegOutputTSTSID	mpegOutputTsNtPid	n
1	100	100	mpts(2)	qam(2)	1.3.6.1.4.1.5591.1.11.5.4.2.6.1.100.1	2	1000	16
2	137	137	mpts(2)	qam(2)	1.3.6.1.4.1.5591.1.11.5.4.2.6.1.137.1	2	1000	16
3	138	138	qam(2)		1.3.6.1.4.1.5591.1.11.5.4.2.6.1.138.1	0	1038	16

Figure II-1 - Identifying a Replicated QAM by Looking at mpegOutputTSTSID

## Appendix III Vendor Schema Version in the CCAP XSD (Informative)

The CCAP XSD provides a complex data type that allow the major, minor, and micro version numbers to be specified for a vendor-specific extension. This complex type may be used in a vendor-specific extension, but is not mandatory. The composition of this complex type is shown here:

```
<xs:complexType name="vendor-extension-version-type">
  <xs:sequence>
    <xs:element name="major-version" type="xs:unsignedInt" minOccurs="1" maxOccurs="1">
      <xs:annotation>
        <xs:documentation>
          Major version provides the macro versioning number for each interface.
          Versions containing the same major version should provide backwards
          compatibility.
        </xs:documentation>
      </xs:annotation>
    </xs:element>
    <xs:element name="minor-version" type="xs:int" minOccurs="1" maxOccurs="1">
      <xs:annotation>
        <xs:documentation>
          MinorVersion identifies incremental and
          backwards compatible updates to a major version.
        </xs:documentation>
      </xs:annotation>
    </xs:element>
    <xs:element name="micro-version" type="xs:int" minOccurs="0" maxOccurs="1">
      <xs:annotation>
        <xs:documentation>
          MicroVersion is usually for bug fixes, without changes in functionality.
        </xs:documentation>
      </xs:annotation>
    </xs:element>
    <xs:element name="ext" type="ext-type" minOccurs="0"/>
  </xs:sequence>
</xs:complexType>
```

## Appendix IV Converting YANG to XSD (Informative)

### IV.1 Using PYANG to Generate an XSD from the CCAP YANG Modules

The CCAP XML Schema is derived by an automated process that converts the standard CCAP YANG modules specified in [CCAP-CONFIG-YANG] into a valid schema file. The conversion of the YANG to XSD is performed by pyang-a YANG validator, transformer, and code generator, written in Python. While CableLabs manages the conversion of the CCAP YANG file into the CCAP schema file (XSD), pyang can be used by anyone to convert the CCAP YANG modules into a valid XSD.

Note that pyang requires Python to run; installing Python is beyond the scope of this specification.

To run pyang on the CCAP YANG module file to produce a valid instance of the CCAP XSD, complete the following steps:

1. Download the most recent version of pyang from the Google Code repository located at: <http://code.google.com/p/pyang/downloads/>
2. Install pyang according to the installation instructions found on this site.
3. Download the most recent version of the CCAP XSD translator plugin (ccapxsd.py) from the following location: <http://www.cablelabs.com/YANG/DOCSIS>
4. Place the ccapxsd.py file in the pyang/plugins directory; this directory will be located within the site local Python library directory.

5. Ensure that the following files are present in the local directory:

- ietf-inet-types.yang (2010-09-24)
- ietf-yang-types.yang (2010-09-24)
- ccap@yyyy-mm-dd.yang (the most recent version of the CCAP YANG module file)

These files can be obtained from the following location: <http://www.cablelabs.com/YANG/DOCSIS>

6. Run the pyang tool with the following command line options:

```
pyang -f ccapxsd --ccapxsd-global-complex-types --inline-type -o ccap@yyyy-mm-dd.xsd
ccap@yyyy-mm-dd.yang
```

where yyyy-mm-dd represents the date on which the most recent version of the YANG module file was published.

This will produce an XML Schema file in the local directory.

It should be noted that pyang currently does not support creating a valid CCAP schema when vendor extensions to the standard CCAP YANG module file are included in a separate file.

### IV.1 Creating In-Line Data Types in the CCAP.XSD

During the conversion process, pyang converts containers and lists that have the same name to a complex type that can be reused throughout the model. While this conversion increases the extensibility of the configuration object model, there are cases in which these definitions should not be converted to a complex type; there is value in allowing them to be unique and extended on an individual basis.

To allow for these containers and lists to be extended on an individual basis, the YANG extension “inlineType” has been created. This extension, when placed in a container or list, inhibits the generation of a named complex type, leaving the type definition in-line. This allows the desired separate extension points for each occurrence.

One example of where this is useful is the ip-interface list in the virtual-interface-group. This grouping is included for both cable-bundle and loopback interfaces. Given that these interface types are very different, it is likely that a vendor would want to extend them differently, which is now allowed by the inlineType extension.

The following example shows this usage:

```
grouping virtual-interface-group {
  leaf interface-index {
    type uint8;
    mandatory true;
    description "The index for this virtual ip-interface";
  }
  leaf admin-state {
    type admin-state-type;
    default down;
    description "This attribute configures the administrative state of the virtual
interface.";
  }
  list ip-interface {
    key ip-interface-name;
    max-elements 1;
    ccap:inlineType;
    description "An ip-interface object.";
    uses ip-interface-group;
    container yang-ext {
      ccap:extensionPoint; //different pyang flags impact use of this hint
      description "node for vendor YANG extensions";
    }
  }
}
```

The extension is enabled on the pyang command line:

```
pyang -o ccap@2012-10-31.xsd -f ccapxsd --ccapxsd-global-complex-types
--inline-type ccap@2012-10-31.yang
```

## Appendix V DOCSIS IPDR Sample Instance Documents (Informative)

This appendix provides a sampling of the XML Instance Documents which conform to the corresponding DOCSIS IPDR Service Definition schemas defined in Section 8.

### V.1 Collector Aggregation

IPDRDoc is expected to be aggregated by the Collector with the IPDR/SP data streamed within the session start stop boundary.

### V.2 Schema Location

The schemaLocation attribute [W3 XSD1.0] is used to associate a XML Instance Document to a published schema XSD document.

The DOCSIS XML Schema location is defined and maintained by CableLabs as:

[http://www.cablelabs.com/namespaces/DOCSIS/3.0/xsd/ipdr/<Service-Definition-Schema>\\_3.5.1-A.1.xsd](http://www.cablelabs.com/namespaces/DOCSIS/3.0/xsd/ipdr/<Service-Definition-Schema>_3.5.1-A.1.xsd)

**NOTE:** The schema location is a Uniform Resource Locator (URL) which points to the actual schema file.

### V.3 DIAG-LOG-TYPE

This section provides a sample XML Instance Document for the Diagnostic Log Service Definition, DIAG-LOG-TYPE and corresponding XML Schema DOCSIS-DIAG-LOG-TYPE\_3.5.1-A.2.xsd.

#### V.3.1 Use Case

The CMTS "cmts01.mso.com" logs an entry in its diagnostic log for the CM with MAC Address 00-09-36-A7-70-89 when the CM fails to register. The CM last registered at 9:15 on 06/04/2006. The registration trigger count has reached 3. The CM was originally added to the diagnostic log at 9:30 on 06/04/2006. The latest trigger occurred at 6:30 on 06/05/2006. The CMTS streams this information to a Collector as shown in the following instance document.

#### V.3.2 Instance Document

```
<?xml version="1.0"?>
<ipdr:IPDRDoc xmlns:ipdr="http://www.ipdr.org/namespaces/ipdr"
  xmlns:xsi="http://www.w3.org/2001/XMLSchema-instance"
  xmlns="http://www.cablelabs.com/namespaces/DOCSIS/3.0/xsd/ipdr/DOCSIS-DIAG-LOG-TYPE"
  xmlns:DOCSIS-DIAG-LOG="http://www.cablelabs.com/namespaces/DOCSIS/3.0/xsd/ipdr/DOCSIS-
DIAG-LOG"
  xmlns:DOCSIS-REC="http://www.cablelabs.com/namespaces/DOCSIS/3.0/xsd/ipdr/DOCSIS-REC"
  xmlns:DOCSIS-CM="http://www.cablelabs.com/namespaces/DOCSIS/3.0/xsd/ipdr/DOCSIS-CM"
  xsi:schemaLocation="http://www.cablelabs.com/namespaces/DOCSIS/3.0/xsd/ipdr/DOCSIS-DIAG-
LOG-TYPE
  http://www.cablelabs.com/namespaces/DOCSIS/3.0/xsd/ipdr/DOCSIS-DIAG-LOG-TYPE/DOCSIS-
DIAG-LOG-TYPE_3.5.1-A.2.xsd"
  docId="3d07ba27-0000-0000-0000-1a2b3c4d5e6f"
  creationTime="2006-06-05T07:11:00Z"
  IPDRRecorderInfo="cmts01.mso.com"
  version="3.5.1-A.2">
  <ipdr:IPDR xsi:type="DIAG-LOG-TYPE">
    <DOCSIS-CMTS:CmtsHostName>cmts01.mso.com.</DOCSIS-CMTS:CmtsHostName>
    <DOCSIS-CM:CmMacAddr>00-09-36-A7-70-89</DOCSIS-CM:CmMacAddr>
    <DOCSIS-DIAG-LOG>LastUpdateTime>2006-06-05T06:30:00Z</DOCSIS-DIAG-LOG>LastUpdateTime>
    <DOCSIS-DIAG-LOG>CreateTime>2006-06-04T09:30:00Z</DOCSIS-DIAG-LOG>CreateTime>
    <DOCSIS-DIAG-LOG>LastRegTime>2006-06-04T09:15:00Z</DOCSIS-DIAG-LOG>LastRegTime>
    <DOCSIS-DIAG-LOG:RegCount>3</DOCSIS-DIAG-LOG:RegCount>
    <DOCSIS-DIAG-LOG:RangingRetryCount>0</DOCSIS-DIAG-LOG:RangingRetryCount>
    <DOCSIS-REC:RecType>1</DOCSIS-REC:RecType>
  </ipdr:IPDR>
  <ipdr:IPDRDoc.End count="1" endTime="2006-06-05T07:15:00Z"/>
</ipdr:IPDRDoc>
```

## V.4 DIAG-LOG-DETAIL-TYPE

This section provides a sample XML Instance Document for the Diagnostic Log Service Definition, DIAG-LOG-DETAIL-TYPE and corresponding XML Schema DOCSIS-DIAG-LOG-DETAIL-TYPE\_3.5.1-A.2.xsd.

### V.4.1 Use Case

The CMTS "cmts01.mso.com" logs an entry in its diagnostic log for the CM with MAC Address 00-09-36-A7-70-89 when the CM fails to register. The CM last triggered a registration diagnostic log entry at 6:30 on 06/05/2006. The detail Count of 1 represents the total number of times the CM had reached the startRegistration (TypeValue=11) state before failing the registration process. The corresponding event is:

<73000401> Service Unavailable - Unrecognized configuration setting

The CMTS streams this information to a Collector as shown in the following instance document.

### V.4.2 Instance Document

```
<?xml version="1.0"?>
<ipdr:IPDRDoc xmlns:ipdr="http://www.ipdr.org/namespaces/ipdr"
  xmlns:xsi="http://www.w3.org/2001/XMLSchema-instance"
  xmlns="http://www.cablelabs.com/namespaces/DOCSIS/3.0/xsd/ipdr/DOCSIS-DIAG-LOG-DETAIL-
TYPE"
  xmlns:DOCSIS-DIAG-LOG-
DETAIL="http://www.cablelabs.com/namespaces/DOCSIS/3.0/xsd/ipdr/DOCSIS-DIAG-LOG-DETAIL"
  xmlns:DOCSIS-REC="http://www.cablelabs.com/namespaces/DOCSIS/3.0/xsd/ipdr/DOCSIS-REC"
  xmlns:DOCSIS-CM="http://www.cablelabs.com/namespaces/DOCSIS/3.0/xsd/ipdr/DOCSIS-CM"
  xsi:schemaLocation="http://www.cablelabs.com/namespaces/DOCSIS/3.0/xsd/ipdr/DOCSIS-DIAG-
LOG-DETAIL-TYPE
  http://www.cablelabs.com/namespaces/DOCSIS/3.0/xsd/ipdr/DOCSIS-DIAG-LOG-DETAIL-
TYPE/DOCSIS-DIAG-LOG-DETAIL-TYPE_3.5.1-A.2.xsd"
  docId="3d07ba27-0000-0000-0000-1a2b3c4d5e6f"
  creationTime="2006-06-05T07:11:00Z"
  IPDRRecorderInfo="cmts01.mso.com"
  version="3.5.1-A.2">
  <ipdr:IPDR xsi:type="DIAG-LOG-DETAIL-TYPE">
    <DOCSIS-CMTS:CmtsHostName>cmts01.mso.com.</DOCSIS-CMTS:CmtsHostName>
    <DOCSIS-CM:CmMacAddr>00-09-36-A7-70-89</DOCSIS-CM:CmMacAddr>
    <DOCSIS-DIAG-LOG-DETAIL:TypeValue>11</DOCSIS-DIAG-LOG-DETAIL:TypeValue>
    <DOCSIS-DIAG-LOG-DETAIL:Count>1</DOCSIS-DIAG-LOG-DETAIL:Count>
    <DOCSIS-DIAG-LOG-DETAIL:LastUpdate>2006-06-05T06:30:00Z</DOCSIS-DIAG-LOG-
DETAIL:LastUpdate>
    <DOCSIS-DIAG-LOG-DETAIL:LastErrorText>
      &lt;73000401&gt; Service Unavailable - Unrecognized configuration setting
    </DOCSIS-DIAG-LOG-DETAIL:LastErrorText>
    <DOCSIS-REC:RecType>1</DOCSIS-REC:RecType>
  </ipdr:IPDR>
  <ipdr:IPDRDoc.End count="1" endTime="2006-06-05T07:15:00Z"/>
</ipdr:IPDRDoc>
```

## V.5 DIAG-LOG-EVENT-TYPE

This section provides a sample XML Instance Document for the Diagnostic Log Service Definition, DIAG-LOG-EVENT-TYPE and corresponding XML Schema DOCSIS-DIAG-LOG-EVENT-TYPE\_3.5.1-A.2.xsd.

### V.5.1 Use Case

At the CMTS sysUpTime "2226878", the CMTS "cmts01.mso.com" detects a diagnostic log trigger for the CM with MAC Address 00-09-36-A7-70-89 when the CM fails to register (TriggerFlagValue of 1 indicates a registration trigger). The CM had reached the startRegistration (TypeValue=11) state before failing the registration process. The corresponding event is:

<73000401> Service Unavailable - Unrecognized configuration setting

Since the RecType value of 4 indicates an event based record, the CMTS autonomously streams this information to a Collector as shown in the following instance document.

## V.5.2 Instance Document

```
<?xml version="1.0"?>
<ipdr:IPDRDoc xmlns:ipdr="http://www.ipdr.org/namespaces/ipdr"
  xmlns:xsi="http://www.w3.org/2001/XMLSchema-instance"
  xmlns="http://www.cablelabs.com/namespaces/DOCSIS/3.0/xsd/ipdr/DOCSIS-DIAG-LOG-EVENT-
TYPE"
  xmlns:DOCSIS-DIAG-LOG="http://www.cablelabs.com/namespaces/DOCSIS/3.0/xsd/ipdr/DOCSIS-
DIAG-LOG"
  xmlns:DOCSIS-DIAG-LOG-
DETAIL="http://www.cablelabs.com/namespaces/DOCSIS/3.0/xsd/ipdr/DOCSIS-DIAG-LOG-DETAIL"
  xmlns:DOCSIS-CMTS="http://www.cablelabs.com/namespaces/DOCSIS/3.0/xsd/ipdr/DOCSIS-CMTS"
  xmlns:DOCSIS-REC="http://www.cablelabs.com/namespaces/DOCSIS/3.0/xsd/ipdr/DOCSIS-REC"
  xmlns:DOCSIS-CM="http://www.cablelabs.com/namespaces/DOCSIS/3.0/xsd/ipdr/DOCSIS-CM"
  xsi:schemaLocation="http://www.cablelabs.com/namespaces/DOCSIS/3.0/xsd/ipdr/DOCSIS-DIAG-
LOG-EVENT-TYPE
  http://www.cablelabs.com/namespaces/DOCSIS/3.0/xsd/ipdr/DOCSIS-DIAG-LOG-EVENT-
TYPE/DOCSIS-DIAG-LOG-EVENT-TYPE_3.5.1-A.2.xsd"
  docId="3d07ba27-0000-0000-0000-1a2b3c4d5e6f"
  creationTime="2006-06-05T07:11:00Z"
  IPDRRecorderInfo="cmts01.mso.com"
  version="3.5.1-A.2">
  <ipdr:IPDR xsi:type="DIAG-LOG-EVENT-TYPE">
    <DOCSIS-CMTS:CmtsHostName>cmts01.mso.com.</DOCSIS-CMTS:CmtsHostName>
    <DOCSIS-CM:CmMacAddr>00-09-36-A7-70-89</DOCSIS-CM:CmMacAddr>
    <DOCSIS-CMTS:CmtsSysUpTime>2226878</DOCSIS-CMTS:CmtsSysUpTime>
    <DOCSIS-DIAG-LOG:TriggerFlagValue>1</DOCSIS-DIAG-LOG:TriggerFlagValue>
    <DOCSIS-DIAG-LOG-DETAIL:TypeValue>11</DOCSIS-DIAG-LOG-DETAIL:TypeValue>
    <DOCSIS-DIAG-LOG-DETAIL:LastErrorText>
      &lt;73000401&gt; Service Unavailable - Unrecognized configuration setting
    </DOCSIS-DIAG-LOG-DETAIL:LastErrorText>
    <DOCSIS-REC:RecType>4</DOCSIS-REC:RecType>
  </ipdr:IPDR>
  <ipdr:IPDRDoc.End count="1" endTime="2006-06-05T07:15:00Z"/>
</ipdr:IPDRDoc>
```

## V.6 SPECTRUM-MEASUREMENT-TYPE

This section provides a sample XML Instance Document for the Spectrum Measurement Service Definition, SPECTRUM-MEASUREMENT-TYPE and corresponding XML Schema DOCSIS-SPECTRUM-MEASUREMENT-TYPE\_3.5.1-A.2.xsd.

### V.6.1 Use Case

Refer to "Use Case 3 Data Analysis" in Appendix VI.2.2.3 for the Use Case defining the following XML Instance Document.

This instance document includes the "current" data plot from the Use Case mentioned above. For clarity, each eight data points in the element SpectrumAnalysisMeasAmplitude of the XML Instance Document are shown per line inside the comment above the element instance. The Center Frequency data is indicated in one line alone (i.e., "FFF5"). Each data point in the comment is delimited with a single space for readability and is not part of the actual XML Instance Document.

### V.6.2 Instance Document

```
<ipdr:IPDRDoc xmlns="http://www.cablelabs.com/namespaces/DOCSIS/3.0/xsd/ipdr/DOCSIS-SPECTRUM-
MEASUREMENT-TYPE" xmlns:DOCSIS-
CMTS="http://www.cablelabs.com/namespaces/DOCSIS/3.0/xsd/ipdr/DOCSIS-CMTS"
  xmlns:DOCSIS-
SPECTRUM="http://www.cablelabs.com/namespaces/DOCSIS/3.0/xsd/ipdr/DOCSIS-SPECTRUM"
  xmlns:ipdr="http://www.ipdr.org/namespaces/ipdr" xmlns:xsi="http://www.w3.org/2001/XMLSchema-
instance" IPDRRecorderInfo="cmts01.mso.com"
  creationTime="2006-06-05T07:11:00Z" docId="3d07ba27-0000-0000-0000-1a2b3c4d5e6f"
  version="3.5.1-A.2"
  xsi:schemaLocation="http://www.cablelabs.com/namespaces/DOCSIS/3.0/xsd/ipdr/DOCSIS-
SPECTRUM-MEASUREMENT-TYPE
  http://www.cablelabs.com/namespaces/DOCSIS/3.0/xsd/ipdr/DOCSIS-SPECTRUM-
MEASUREMENT-TYPE/DOCSIS-SPECTRUM-MEASUREMENT-TYPE_3.5.1-A.2.xsd">
```



```

<ipdr:IPDR xsi:type="SPECTRUM-MEASUREMENT-TYPE">
  <DOCSIS-CMTS:CmtsHostName>cmts01.mso.com.</DOCSIS-CMTS:CmtsHostName>
  <DOCSIS-CMTS:CmtsSysUpTime>2226878</DOCSIS-CMTS:CmtsSysUpTime>
  <DOCSIS-CMTS:CmtsMdIfIndex>1</DOCSIS-CMTS:CmtsMdIfIndex>
  <DOCSIS-SPECTRUM:SpectrumAnalysisMeasIfIndex>5</DOCSIS-
SPECTRUM:SpectrumAnalysisMeasIfIndex>
  <DOCSIS-SPECTRUM:ChId>2</DOCSIS-SPECTRUM:ChId>
  <DOCSIS-SPECTRUM:SpectrumAnalysisMeasChCenterFreq>25000000</DOCSIS-
SPECTRUM:SpectrumAnalysisMeasChCenterFreq>
  <DOCSIS-SPECTRUM:SpectrumAnalysisMeasFreqSpan>6400000</DOCSIS-
SPECTRUM:SpectrumAnalysisMeasFreqSpan>
  <DOCSIS-SPECTRUM:SpectrumAnalysisMeasNumOfBins>257</DOCSIS-
SPECTRUM:SpectrumAnalysisMeasNumOfBins>
  <DOCSIS-SPECTRUM:SpectrumAnalysisMeasResolutionBW>25000</DOCSIS-
SPECTRUM:SpectrumAnalysisMeasResolutionBW>
  <DOCSIS-SPECTRUM:SpectrumAnalysisMeasBinSpacing>12500</DOCSIS-
SPECTRUM:SpectrumAnalysisMeasBinSpacing>
  <!-- The following data instance is formatted for readability
    F07A F7F4 FC64 FE23 FEDE FFF7 FFDF FFF9
    FFFA FFFC FFF8 FFF0 FFF7 000F 000C FFF7
    0009 001B FFE8 FFFE FFDA FFE9 FFFE FFEB
    0007 0001 0002 0004 000A 0014 FFFD 000C
    FFFB 0029 000A FFFB FFFA FFDC 000B FFFA
    FFF8 0003 FFF3 000E FFEF FFE6 FFFE FFF3
    FFF7 FFD0 FFF7 0013 FFFD 0009 000D 001A
    0016 FFE4 0013 FFF7 0010 000A 0019 0005
    0019 0000 0003 FFF8 FFDE FFFB 0009 0007
    FFEA FFF5 0006 FFFC 0339 074A 06A4 0010
    0011 0030 FFF1 0022 0028 FFFE FFF3 0001
    0001 FFFF FFF7 001D FFFB FFFB FFED FFFF
    000D FFF7 FFF9 0002 000B FFE6 000B 0018
    0004 001F FFF5 0003 000F 0005 FFE6 001B
    FFFB 000A 0000 000E 000A 0019 0022 0017
    FFED FFE6 000F FFF4 0008 FFE3 FFEC 0020
    FFF5
    0025 0018 FFD5 FFE8 FFF7 0017 FFF1 0013
    FFFD FFEB 0003 FFFE FFF3 FFF8 0017 0015
    FFE6 FFEC FFE6 001A 0029 FFFF FFF7 FFFA
    FFE0 FFF3 000C 0001 0002 000A FFF9 FFE2
    0022 0016 0008 0013 0006 FFFF FFF0 000F
    0000 0006 FFED 001F FFF2 0006 FFFD FFF5
    0000 0019 0009 FFC1 FFE8 0008 0026 001D
    0018 FFFD 0003 FFFE 001D 0009 0004 FFE7
    FFF5 001C 0027 FFE7 000B FFFF FFF0 FFDC
    FFE1 001B 001C 0034 FFFD 0008 0000 0027
    0009 FFF0 FFF2 FFFE FFFA FFFB 0014 0016
    FFFE FFFE 0018 0000 0006 FFDC FFF6 FFFE
    FFFF 000A 000E 0015 0023 FFF5 0001 000C
    000B 0001 FFF9 000E 0024 FFF7 0000 FFFE
    0022 FFEF 000F FFFC 0002 0004 0011 FFF2
    000D FFFB 000F FEFA FE39 FBED F87E F098 -->
  <DOCSIS-
SPECTRUM:SpectrumAnalysisMeasAmplitude>F07AF7F4FC64FE23FEDEFFF7FFDFFFF9FFFAFFFCFFF8FFF0FFF7000F00
0CFFF70009001BFFE8FFFEFFDADF9FFFEFFEB0007000100020004000A0014FFFD000CFFFB0029000AFFFBFFFAFFDC000
BFFFAFFF80003FFF3000EFFEFFF6FFFEFFF3FFF7FFD0FFF70013FFFD0009000D001A0016FFE40013FFF70010000A0019
0005001900000003FFF8FFDEFFF800090007FFEAF50006FFFC0339074A06A4001000110030FFF100220028FFFEFFF30
0010001FFFFF7001DFFFBFFFBFFEDFFF000DFFF7FFF90002000BFFEB000B00180004001FFFF50003000F0005FFE600
1BFFFB000A0000000E000A001900220017FFEDFFEE000FFF40008FFE3FFEC0020FFF500250018FFD5FFE8FFF70017FFF
10013FFFDFFEB0003FFFEFF3FFF800170015FFEEFFECFFE6001A0029FFFFFFF7FFFAFFE0FFF3000C00010002000AFFF9
FFE200220016000800130006FFFE000F00000006FFED0013FFF20006FFFDFFF5000000190009FFC1FFE8000800260
01D0018FFFD0003FFFE001D00090004FFE7FFF5001C0027FFE7000BFFFFFFF0FFDCFFE1001B001C0034FFFD00080000000
270009FFF0FFF2FFFEFFFAFFFB00140016FFFEFFFE001800000006FFDCFFF6FFFEFFF000A000E00150023FFF50001000
C000B0001FFF9000E0024FFF70000FFFE0022FFEF000FFFFC000200040011FFF2000DFFF000FFFAFE39FBEDF87EF098
</DOCSIS-SPECTRUM:SpectrumAnalysisMeasAmplitude>
</ipdr:IPDR>
  <ipdr:IPDRDoc.End count="1" endTime="2006-06-05T07:15:00Z"></ipdr:IPDRDoc.End>
</ipdr:IPDRDoc>

```

## V.7 CMTS-CM-US-STATS-TYPE

This section provides a sample XML Instance Document for the CMTS CM Upstream Statistics Service Definition, CMTS-CM-US-STATS-TYPE and corresponding XML Schema DOCSIS-CMTS-CM-US-STATS-TYPE\_3.5.1-A.2.xsd.

### V.7.1 Use Case

At a CMTS sysUpTime of "2226878", the CMTS "cmts01.mso.com" with MAC Domain ifName of "Int0/1" and MAC Domain ifIndex of "456", streams the upstream status information of a CM with MAC Address "00-09-36-A7-70-89" connected to upstream channel ifName of "Int0/1/4" and upstream channel ifIndex of "17". In addition, the CmRegStatusId of "1" and the following upstream status information of CM are included in the record:

```

ModulationType = 1
RxPower = -5
SignalNoise = 361
Microreflections = 0
EqData = 0x0401080000700028ff60ffa0018000783db000000080fe98ff70ffe8ff58003800480138
Unerroreds = 219678
Correcteds = 10
Uncorrectables = 5
HighResolutionTimingOffset = 5
IsMuted = 0
RangingStatus = 4

```

### V.7.2 Instance Document

```

<?xml version="1.0"?>
<ipdr:IPDRDoc xmlns:ipdr="http://www.ipdr.org/namespaces/ipdr"
  xmlns:xsi="http://www.w3.org/2001/XMLSchema-instance"
  xmlns="http://www.cablelabs.com/namespaces/DOCSIS/3.0/xsd/ipdr/DOCSIS-CMTS-CM-US-STATS-
TYPE"
  xmlns:DOCSIS-CMTS="http://www.cablelabs.com/namespaces/DOCSIS/3.0/xsd/ipdr/DOCSIS-CMTS"
  xmlns:DOCSIS-CM="http://www.cablelabs.com/namespaces/DOCSIS/3.0/xsd/ipdr/DOCSIS-CM"
  xmlns:DOCSIS-CMTS-CM-US="http://www.cablelabs.com/namespaces/DOCSIS/3.0/xsd/ipdr/DOCSIS-
CMTS-CM-US"
  xmlns:DOCSIS-REC="http://www.cablelabs.com/namespaces/DOCSIS/3.0/xsd/ipdr/DOCSIS-REC"
  xsi:schemaLocation="http://www.cablelabs.com/namespaces/DOCSIS/3.0/xsd/ipdr/DOCSIS-CMTS-
CM-US-STATS-TYPE
  http://www.cablelabs.com/namespaces/DOCSIS/3.0/xsd/ipdr/DOCSIS-CMTS-CM-US-STATS-
TYPE/DOCSIS-CMTS-CM-US-STATS-TYPE_3.5.1-A.2.xsd"
  docId="3d07ba27-0000-0000-0000-1a2b3c4d5e6f"
  creationTime="2006-06-05T07:11:00Z"
  IPDRRecorderInfo="cmts01.mso.com"
  version="3.5.1-A.2">
<ipdr:IPDR xsi:type="CMTS-CM-US-STATS-TYPE">
  <DOCSIS-CMTS:CmtsHostName>cmts01.mso.com</DOCSIS-CMTS:CmtsHostName>
  <DOCSIS-CMTS:CmtsSysUpTime>2226878</DOCSIS-CMTS:CmtsSysUpTime>
  <DOCSIS-CMTS:CmtsMdIfName>Int0/1</DOCSIS-CMTS:CmtsMdIfName>
  <DOCSIS-CMTS:CmtsMdIfIndex>456</DOCSIS-CMTS:CmtsMdIfIndex>
  <DOCSIS-CM:CmMacAddr>00-09-36-A7-70-89</DOCSIS-CM:CmMacAddr>
  <DOCSIS-CM:CmRegStatusId>1</DOCSIS-CM:CmRegStatusId>
  <DOCSIS-CMTS-CM-US:CmtsCmUsChIfName>Int0/1/4</DOCSIS-CMTS-CM-US:CmtsCmUsChIfName>
  <DOCSIS-CMTS-CM-US:CmtsCmUsChIfIndex>17</DOCSIS-CMTS-CM-US:CmtsCmUsChIfIndex>
  <DOCSIS-CMTS-CM-US:CmtsCmUsChId>5</DOCSIS-CMTS-CM-US:CmtsCmUsChId>
  <DOCSIS-CMTS-CM-US:CmtsCmUsModulationType>1</DOCSIS-CMTS-CM-US:CmtsCmUsModulationType>
  <DOCSIS-CMTS-CM-US:CmtsCmUsRxPower>-5</DOCSIS-CMTS-CM-US:CmtsCmUsRxPower>
  <DOCSIS-CMTS-CM-US:CmtsCmUsSignalNoise>361</DOCSIS-CMTS-CM-US:CmtsCmUsSignalNoise>
  <DOCSIS-CMTS-CM-US:CmtsCmUsMicroreflections>0</DOCSIS-CMTS-CM-

```

```

US:CmtsCmUsMicroreflections>
  <DOCSIS-CMTS-CM-US:CmtsCmUsEqData>
    0401080000700028ff60ffa0018000783db00000080fe98ff70ffe8ff58003800480138
  </DOCSIS-CMTS-CM-US:CmtsCmUsEqData>
  <DOCSIS-CMTS-CM-US:CmtsCmUsUnerrored>219678</DOCSIS-CMTS-CM-US:CmtsCmUsUnerrored>
  <DOCSIS-CMTS-CM-US:CmtsCmUsCorrected>10</DOCSIS-CMTS-CM-US:CmtsCmUsCorrected>
  <DOCSIS-CMTS-CM-US:CmtsCmUsUncorrectables>5</DOCSIS-CMTS-CM-US:CmtsCmUsUncorrectables>
  <DOCSIS-CMTS-CM-US:CmtsCmUsHighResolutionTimingOffset>5</DOCSIS-CMTS-CM-
US:CmtsCmUsHighResolutionTimingOffset>
  <DOCSIS-CMTS-CM-US:CmtsCmUsIsMuted>0</DOCSIS-CMTS-CM-US:CmtsCmUsIsMuted>
  <DOCSIS-CMTS-CM-US:CmtsCmUsRangingStatus>4</DOCSIS-CMTS-CM-US:CmtsCmUsRangingStatus>
  <DOCSIS-REC:RecType>1</DOCSIS-REC:RecType>
</ipdr:IPDR>
  <ipdr:IPDRDoc.End count="1" endTime="2006-06-05T07:15:00Z"/>
</ipdr:IPDRDoc>

```

## V.8 CMTS-CM-REG-STATUS-TYPE<sup>246</sup>

This section provides a sample XML Instance Document for the CMTS CM Registration Status Service Definition, CMTS-CM-REG-STATUS-TYPE and corresponding XML Schema DOCSIS-CMTS-CM-REG-STATUS-TYPE\_3.5.1-B.1.xsd.

### V.8.1 Use Case

At a CMTS sysUpTime of "2226878", the CMTS "cmts01.mso.com" with MAC Domain ifName of "Int0/1" and MAC Domain ifIndex of "456", streams the registration status information of a CM with MAC Address "00-09-36-A7-70-89", having an ip4Address of "55.12.48.113", ipv6Address of "2001:0400:0000:0000:0209:36FF:FEA7:7089", ipv6 link local address of "FE80:0000:0000:0000:0209:36FF:FEA7:7089", registration status value of "8" and QoSVersion as "2"(DOCSIS 1.1 QoS mode). The CM last registered with the CMTS at 9:15GMT on 06/04/2006. In addition, the CMTS CM Channel information consisting of MAC Domain Cable Modem Service Group Id of "17", Receive Channel Profile Id of "MYCID", Receive Channel Configuration status Id of "5", Receive Channel Set Id of "5" and Transmit Channel Set If of "5" is also included in the record.

### V.8.2 Instance Document

```

<?xml version="1.0"?>
<ipdr:IPDRDoc xmlns:ipdr="http://www.ipdr.org/namespaces/ipdr"
  xmlns:xsi="http://www.w3.org/2001/XMLSchema-instance"
  xmlns="http://www.cablelabs.com/namespaces/DOCSIS/3.0/xsd/ipdr/DOCSIS-CMTS-CM-REG-
STATUS-TYPE"
  xmlns:DOCSIS-CMTS="http://www.cablelabs.com/namespaces/DOCSIS/3.0/xsd/ipdr/DOCSIS-CMTS"
  xmlns:DOCSIS-CMTS-CM-NODE-
CH="http://www.cablelabs.com/namespaces/DOCSIS/3.0/xsd/ipdr/DOCSIS-CMTS-CM-NODE-CH"
  xmlns:DOCSIS-CM="http://www.cablelabs.com/namespaces/DOCSIS/3.0/xsd/ipdr/DOCSIS-CM"
  xmlns:DOCSIS-REC="http://www.cablelabs.com/namespaces/DOCSIS/3.0/xsd/ipdr/DOCSIS-REC"
  xsi:schemaLocation="http://www.cablelabs.com/namespaces/DOCSIS/3.1/xsd/ipdr/DOCSIS-CMTS-
CM-REG-STATUS-TYPE
  http://www.cablelabs.com/namespaces/DOCSIS/3.1/xsd/ipdr/DOCSIS-CMTS-CM-REG-STATUS-
TYPE/DOCSIS-CMTS-CM-REG-STATUS-TYPE_3.5.1-B.1.xsd"
  docId="3d07ba27-0000-0000-0000-1a2b3c4d5e6f"
  creationTime="2016-06-05T07:11:00Z"
  IPDRRecorderInfo="cmts01.mso.com"
  version="3.5.1-B.1">
<ipdr:IPDR xsi:type="CMTS-CM-REG-STATUS-TYPE">
  <DOCSIS-CMTS:CmtsHostName>cmts01.mso.com</DOCSIS-CMTS:CmtsHostName>
  <DOCSIS-CMTS:CmtsSysUpTime>2226878</DOCSIS-CMTS:CmtsSysUpTime>
  <DOCSIS-CMTS:CmtsMdIfName>Int0/1</DOCSIS-CMTS:CmtsMdIfName>
  <DOCSIS-CMTS:CmtsMdIfIndex>456</DOCSIS-CMTS:CmtsMdIfIndex>
  <DOCSIS-CMTS-CM-NODE-CH:CmtsMdCmSgId>17</DOCSIS-CMTS-CM-NODE-CH:CmtsMdCmSgId>
  <DOCSIS-CMTS-CM-NODE-CH:CmtsRcpId>MYCID</DOCSIS-CMTS-CM-NODE-CH:CmtsRcpId>
  <DOCSIS-CMTS-CM-NODE-CH:CmtsRccStatusId>5</DOCSIS-CMTS-CM-NODE-CH:CmtsRccStatusId>
  <DOCSIS-CMTS-CM-NODE-CH:CmtsRcsId>5</DOCSIS-CMTS-CM-NODE-CH:CmtsRcsId>
  <DOCSIS-CMTS-CM-NODE-CH:CmtsTcsId>5</DOCSIS-CMTS-CM-NODE-CH:CmtsTcsId>

```

<sup>246</sup> Modified per CCAP-OSSiv3.1-15.1390-2 on 11/11/15 by KB.

```

<DOCSIS-CM:CmMacAddr>00-09-36-A7-70-89</DOCSIS-CM:CmMacAddr>
<DOCSIS-CM:CmIpv4Addr>55.12.48.113</DOCSIS-CM:CmIpv4Addr>
<DOCSIS-CM:CmIpv6Addr>2001:0400:0000:0000:0209:36FF:FEA7:7089</DOCSIS-CM:CmIpv6Addr>
<DOCSIS-CM:CmIpv6LinkLocalAddr>FE80:0000:0000:0000:0209:36FF:FEA7:7089</DOCSIS-
CM:CmIpv6LinkLocalAddr>
<DOCSIS-CM:CmQosVersion>2</DOCSIS-CM:CmQosVersion>
<DOCSIS-CM:CmRegStatusValue>8</DOCSIS-CM:CmRegStatusValue>
<DOCSIS-CM:CmLastRegTime>2006-06-04T09:15:00Z</DOCSIS-CM:CmLastRegTime>
<DOCSIS-CM:CmEnergyMgtEnabled>0</DOCSIS-CM:CmEnergyMgtEnabled>
<DOCSIS-CM:CmEnergyMgtOperStatus>0</DOCSIS-CM:CmEnergyMgtOperStatus>
<DOCSIS-OFDM-PROFILE:DsProfileIdList>22040008090a</DOCSIS-OFDM-PROFILE:DsProfileIdList>
<DOCSIS-OFDM-PROFILE:UsProfileIucList>24020506</DOCSIS-OFDM-PROFILE:UsProfileIucList>
<DOCSIS-CMTS-CM-DS-OFDM:TcsPhigh>3</DOCSIS-CMTS-CM-DS-OFDM:TcsPhigh>
<DOCSIS-CMTS-CM-DS-OFDM:TcsDrwTop>0</DOCSIS-CMTS-CM-DS-OFDM:TcsDrwTop>
<DOCSIS-CMTS-CM-DS-OFDM:MinUsableDsFreq>100000000</DOCSIS-CMTS-CM-DS-
OFDM:MinUsableDsFreq>
<DOCSIS-CMTS-CM-DS-OFDM:MaxUsableDsFreq>1200000000</DOCSIS-CMTS-CM-DS-
OFDM:MaxUsableDsFreq>
<DOCSIS-CMTS-CM-US-OFDMA:MaxUsableUsFreq>95000000</DOCSIS-CMTS-CM-US-
OFDMA:MaxUsableUsFreq>
<DOCSIS-CMTS-CM-PARTIAL:PartialSvcState>0</DOCSIS-CMTS-CM-PARTIAL:PartialSvcState>
<DOCSIS-CMTS-CM-PARTIAL:PartialChanState>0</DOCSIS-CMTS-CM-PARTIAL:PartialChanState>
<DOCSIS-REC:RecType>1</DOCSIS-REC:RecType>
<DOCSIS-REC:RecCreationTime>2006-06-05T07:11:00Z</DOCSIS-REC:RecCreationTime>
</ipdr:IPDR>
<ipdr:IPDRDoc.End count="1" endTime="2006-06-05T07:15:00Z"/>
</ipdr:IPDRDoc>

```

## V.9 CMTS-TOPOLOGY-TYPE

This section provides a sample XML Instance Document for the CMTS Topology Service Definition, CMTS-TOPOLOGY-TYPE and corresponding XML Schema DOCSIS-CMTS-TOPOLOGY-TYPE\_3.5.1-A.2.xsd.

### V.9.1 Use Case

At a CMTS sysUpTime of "2226878", the CMTS "cmts01.mso.com" with ipv4Address of "10.40.57.11", ipv6Address of "2001:0400:0000:0000:0000:FF00:FE00:0000", MAC Domain ifName of "Int0/1" and MAC Domain ifIndex of "456", streams the topology information consisting of Node Name as "DENVER288", MAC Domain Cable Modem Service Group Id of "1010", MAC Domain Downstream Service Group Id of "2", MAC Domain Upstream Service Group Id "5", MAC Domain Downstream Service Group Channel List of "01020304" and MAC Domain Upstream Service Group Channel List of "0A0B0C3D".

### V.9.2 Instance Document

```

<?xml version="1.0"?>
<ipdr:IPDRDoc xmlns:ipdr="http://www.ipdr.org/namespaces/ipdr"
  xmlns:xsi="http://www.w3.org/2001/XMLSchema-instance"
  xmlns="http://www.cablelabs.com/namespaces/DOCSIS/3.0/xsd/ipdr/DOCSIS-CMTS-TOPOLOGY-
TYPE"
  xmlns:DOCSIS-CMTS="http://www.cablelabs.com/namespaces/DOCSIS/3.0/xsd/ipdr/DOCSIS-CMTS"
  xmlns:DOCSIS-MD-NODE="http://www.cablelabs.com/namespaces/DOCSIS/3.0/xsd/ipdr/DOCSIS-MD-
NODE"
  xmlns:DOCSIS-REC="http://www.cablelabs.com/namespaces/DOCSIS/3.0/xsd/ipdr/DOCSIS-REC"
  xsi:schemaLocation="http://www.cablelabs.com/namespaces/DOCSIS/3.0/xsd/ipdr/DOCSIS-CMTS-
TOPOLOGY-TYPE
  http://www.cablelabs.com/namespaces/DOCSIS/3.0/xsd/ipdr/DOCSIS-CMTS-TOPOLOGY-
TYPE/DOCSIS-CMTS-TOPOLOGY-TYPE_3.5.1-A.2.xsd"
  docId="3d07ba27-0000-0000-0000-1a2b3c4d5e6f"
  creationTime="2006-06-05T07:11:00Z"
  IPDRRecorderInfo="cmts01.mso.com"
  version="3.5.1-A.2">
<ipdr:IPDR xsi:type="CMTS-TOPOLOGY-TYPE">
  <DOCSIS-CMTS:CmtsHostName>cmts01.mso.com</DOCSIS-CMTS:CmtsHostName>
  <DOCSIS-CMTS:CmtsSysUpTime>2226878</DOCSIS-CMTS:CmtsSysUpTime>
  <DOCSIS-CMTS:CmtsIpv4Addr>10.40.57.11</DOCSIS-CMTS:CmtsIpv4Addr>
  <DOCSIS-CMTS:CmtsIpv6Addr>2001:0400:0000:0000:0000:FF00:FE00:0000</DOCSIS-
CMTS:CmtsIpv6Addr>
  <DOCSIS-CMTS:CmtsMdIfName>Int0/1</DOCSIS-CMTS:CmtsMdIfName>

```

```

<DOCSIS-CMTS:CmtsMdIfIndex>456</DOCSIS-CMTS:CmtsMdIfIndex>
<DOCSIS-MD-NODE:CmtsNodeName>DENVER2881</DOCSIS-MD-NODE:CmtsNodeName>
<DOCSIS-MD-NODE:CmtsMdCmSgId>1010</DOCSIS-MD-NODE:CmtsMdCmSgId>
<DOCSIS-MD-NODE:CmtsMdDsSgId>2</DOCSIS-MD-NODE:CmtsMdDsSgId>
<DOCSIS-MD-NODE:CmtsMdUsSgId>5</DOCSIS-MD-NODE:CmtsMdUsSgId>
<DOCSIS-MD-NODE:CmtsMdDsSgChList>01020304</DOCSIS-MD-NODE:CmtsMdDsSgChList>
<DOCSIS-MD-NODE:CmtsMdUsSgChList>0A0B0C3D</DOCSIS-MD-NODE:CmtsMdUsSgChList>
<DOCSIS-REC:RecType>1</DOCSIS-REC:RecType>
</ipdr:IPDR>
<ipdr:IPDRDoc.End count="1" endTime="2006-06-05T07:15:00Z"/>
</ipdr:IPDRDoc>

```

## V.10 CPE-TYPE

This section provides a sample XML Instance Document for the CPE Service Definition, CPE-TYPE and corresponding XML Schema DOCSIS-CPE-TYPE\_3.5.1-A.2.xsd.

### V.10.1 Use Case

At a CMTS sysUpTime of "2226878", the CMTS "cmts01.mso.com" streams the CPE record for a CPE with MAC Address 00-08-22-B4-66-90 corresponding to a CM with MAC Address 00-09-36-A7-70-89 and a CMTS MAC Domain ifName of "Int0/1" and ifIndex of 456. In addition, the CPE IPv4 address of 192.168.0.11, IPv6 address of 2001:0400:0000:0000:1000:FFFF:0000 and FQDN of "somehost.example.com." are included in the record.

### V.10.2 Instance Document

```

<?xml version="1.0"?>
<ipdr:IPDRDoc xmlns:xsi="http://www.w3.org/2001/XMLSchema-instance"
  xmlns:ipdr="http://www.ipdr.org/namespaces/ipdr"
  xmlns="http://www.cablelabs.com/namespaces/DOCSIS/3.0/xsd/ipdr/DOCSIS-CPE-TYPE"
  xmlns:DOCSIS-CPE="http://www.cablelabs.com/namespaces/DOCSIS/3.0/xsd/ipdr/DOCSIS-
CPE"
  xmlns:DOCSIS-CMTS="http://www.cablelabs.com/namespaces/DOCSIS/3.0/xsd/ipdr/DOCSIS-
CMTS"
  xmlns:DOCSIS-CM="http://www.cablelabs.com/namespaces/DOCSIS/3.0/xsd/ipdr/DOCSIS-CM"
  xmlns:DOCSIS-REC="http://www.cablelabs.com/namespaces/DOCSIS/3.0/xsd/ipdr/DOCSIS-
REC"
  xsi:schemaLocation="http://www.cablelabs.com/namespaces/DOCSIS/3.0/xsd/ipdr/DOCSIS-
CPE-TYPE
  http://www.cablelabs.com/namespaces/DOCSIS/3.0/xsd/ipdr/DOCSIS-CPE-TYPE/DOCSIS-
CPE-TYPE_3.5.1-A.2.xsd"
  docId="3d07ba27-0000-0000-0000-1a2b3c4d5e6f" version="3.5.1-A.2"
  creationTime="2006-06-05T07:11:00Z" IPDRRecorderInfo="cmts01.mso.com">
  <ipdr:IPDR xsi:type="CPE-TYPE">
    <DOCSIS-CMTS:CmtsHostName>cmts01.mso.com.</DOCSIS-CMTS:CmtsHostName>
    <DOCSIS-CMTS:CmtsSysUpTime>2226878</DOCSIS-CMTS:CmtsSysUpTime>
    <DOCSIS-CMTS:CmtsMdIfName>Int0/1</DOCSIS-CMTS:CmtsMdIfName>
    <DOCSIS-CMTS:CmtsMdIfIndex>456</DOCSIS-CMTS:CmtsMdIfIndex>
    <DOCSIS-CM:CmMacAddr>00-09-36-A7-70-89</DOCSIS-CM:CmMacAddr>
    <DOCSIS-REC:RecType>1</DOCSIS-REC:RecType>
    <DOCSIS-CPE:CpeMacAddr>00-08-22-B4-66-90</DOCSIS-CPE:CpeMacAddr>
    <DOCSIS-CPE:CpeIpv4AddrList>192.168.0.11</DOCSIS-CPE:CpeIpv4AddrList>
    <DOCSIS-CPE:CpeIpv6AddrList>2001:0400:0000:0000:1000:FFFF:0000</DOCSIS-
CPE:CpeIpv6AddrList>
    <DOCSIS-CPE:CpeFqdn>somehost.example.com.</DOCSIS-CPE:CpeFqdn>
  </ipdr:IPDR>
  <ipdr:IPDRDoc.End count="1" endTime="2006-06-05T07:15:00Z"/>
</ipdr:IPDRDoc>

```

## V.11 SAMIS-TYPE-1 and SAMIS-TYPE-2

### V.11.1 Use Case

The Type 1 and Type 2 XML Instance Documents defined in the following sections represent the same use case, but differ in the amount of data which is streamed. Type 1 streams the full record containing all CMTS, CM and service

statistics counters. The optimized record, Type 2, only streams those elements that are needed in each record instance such that correlation can be performed at the collector.

**NOTE:** The instance documents presented below represent one streaming record for illustrative purposes only. The full set of streaming records for the defined use case are not included.

The use case represented in this section is defined in the following section.

**V.11.1.1 Example Usage Record Streaming Model Containing Diverse Services**

Table V-1 includes a set of records from a bigger set that contains active Service Flows/ CoS for the collection interval from 10:30 AM to 11:00 AM of a day Nov 10 2004 (30 minutes intervals) PCxx correspond to PacketCable 1.5 voice calls; FLPxx correspond to CMs flapping in the registration process after some time being online; CMxx correspond to CMs with steady registration, and passing data. Not all the statistics are presented and for simplicity, only Upstream data is shown in this example.

**Table V-1 - Sample of Records for the Period 10:30 to 11:00 AM**

Device	Time Start	Time End	Time Last (sec)	Rec Type	Device	Time Start	Time End	Time Last (sec)	Rec Type
PC02	10:42:01	10:44:42	161	Stop	CM08	8:16:46	12:05:34	13728	Interim
PC09	10:35:11	10:36:46	95	Stop	CM09	9:47:07	11:36:04	6537	Interim
FLP01	10:44:33	11:07:30	1377	Interim	CM10	9:48:39	11:49:21	7242	Interim
FLP02	10:13:53	10:34:49	1256	Stop	CM11	9:05:29	12:30:36	12307	Interim
FLP02	10:35:25	10:58:08	1363	Stop	CM12	8:40:34	12:17:30	13016	Interim
FLP02	10:58:47	11:14:39	952	Interim	CM14	8:08:13	11:27:41	11968	Interim
FLP03	10:13:39	10:38:26	1487	Stop	CM15	8:04:46	10:44:59	9613	Stop
FLP03	10:39:00	11:05:32	1592	Interim	CM16	9:31:22	11:18:15	6413	Interim
FLP04	10:17:50	10:33:35	945	Stop	CM17	8:44:49	10:53:03	7694	Stop
FLP04	10:34:11	10:56:43	1352	Stop	CM19	9:07:13	11:28:10	8457	Interim
FLP04	10:57:18	11:13:22	964	Interim	CM24	8:02:37	10:35:35	9178	Stop
CM01	9:06:43	11:50:29	9826	Interim	CM25	10:15:27	11:38:47	5000	Interim
CM02	9:54:13	12:31:34	9441	Interim	CM26	10:57:44	11:26:00	1696	Interim
CM03	9:27:57	12:58:43	12646	Interim	CM29	10:10:35	11:34:02	5007	Interim
CM04	8:56:05	12:07:37	11492	Interim	CM32	10:12:35	11:11:12	3517	Interim
CM05	9:03:01	11:30:46	8865	Interim	CM33	10:10:13	12:20:49	7836	Interim
CM06	9:49:23	12:58:20	11337	Interim	CM34	10:57:58	10:58:41	43	Stop
CM07	8:19:37	12:59:17	16780	Interim	CM36	10:58:36	12:38:25	5989	Interim

Table V-1 shows in the left side, an arbitrary set of active CM services from start to end: Basic, Premium and Business services (SCN being associated by the CMTS) are here static services and PacketCable Services (SCN = G711) represent VoIP calls over PacketCable infrastructure. Note that CMTS have signaled in a proprietary manner a SCN = Basic for CMs in 1.0 mode of operation; this could be considered a CMTS specific feature for filling the SCN with the purpose of aggregating that service segment and does not constitute a CMTS requirement

The right side of Figure V-1 corresponds to the records that are reported for the collector interval 10:30 to 11:00 AM as RecType 'Stop' or 'Interim'.

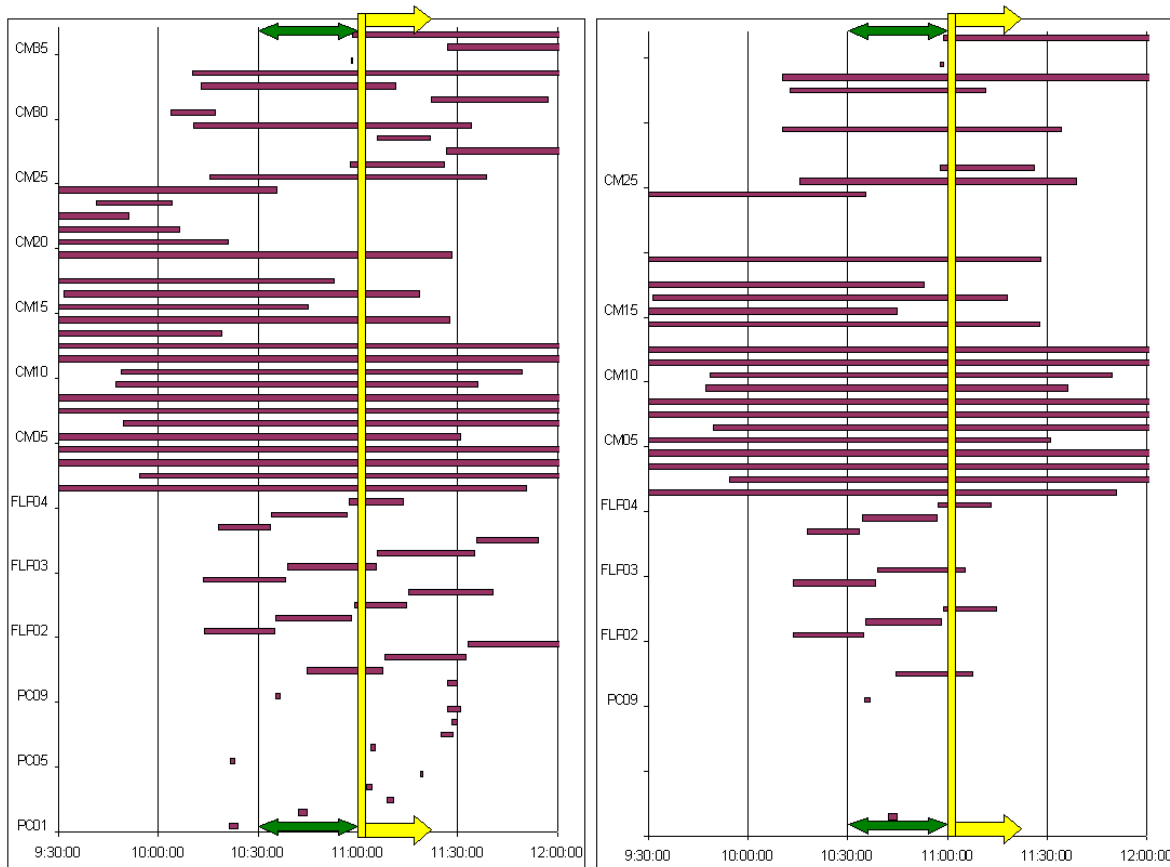

**Figure V-1 - Set of CM Services in an Arbitrary Period of Time (Left Graphic)  
Set of Records Associated to the Collection Interval 10:30 to 11:00 AM (Right Graphic)**

One example instance of the corresponding records sent by exporter for the time interval 10:30 to 11:00 AM as indicated in the figures above is represented in the below IPDRDoc XML format. IPDRDoc is expected to be aggregated by the Collector with the IPDR/SP data streamed within the session start stop boundary.

### V.11.2 SAMIS Type 1 Instance Document

```
<?xml version='1.0' ?>
<ipdr:IPDRDoc xmlns:xsi="http://www.w3.org/2001/XMLSchema-instance"
  xmlns:ipdr="http://www.ipdr.org/namespaces/ipdr"
  xmlns="http://www.cablelabs.com/namespaces/DOCSIS/3.0/xsd/ipdr/DOCSIS-SAMIS-TYPE-1"
  xmlns:DOCSIS-QOS="http://www.cablelabs.com/namespaces/DOCSIS/3.0/xsd/ipdr/DOCSIS-QOS"
  xmlns:DOCSIS-CMTS="http://www.cablelabs.com/namespaces/DOCSIS/3.0/xsd/ipdr/DOCSIS-
CMTS"
  xmlns:DOCSIS-CM="http://www.cablelabs.com/namespaces/DOCSIS/3.0/xsd/ipdr/DOCSIS-CM"
  xmlns:DOCSIS-REC="http://www.cablelabs.com/namespaces/DOCSIS/3.0/xsd/ipdr/DOCSIS-REC"
  xsi:schemaLocation="http://www.cablelabs.com/namespaces/DOCSIS/3.0/xsd/ipdr/DOCSIS-
SAMIS-TYPE-1
  http://www.cablelabs.com/namespaces/DOCSIS/3.0/xsd/ipdr/DOCSIS-SAMIS-TYPE-1/DOCSIS-
SAMIS-TYPE-1_3.5.1-A.1.xsd"
  docId="3d07ba27-0000-0000-0000-1a2b3c4d5e6f"
  version="3.5.1-A.1"
  creationTime="2004-11-10T07:11:05Z"
  IPDRRecorderInfo="cmts01.mso.com">
  <ipdr:IPDR xsi:type="SAMIS-TYPE-1">
    <DOCSIS-CMTS:CmtsHostName>cmts01.mso.com.</DOCSIS-CMTS:CmtsHostName>
    <DOCSIS-CMTS:CmtsSysUpTime>2226878</DOCSIS-CMTS:CmtsSysUpTime>
    <DOCSIS-CMTS:CmtsIpv4Addr>10.40.57.11</DOCSIS-CMTS:CmtsIpv4Addr>
    <DOCSIS-CMTS:CmtsIpv6Addr>2001:0400:0000:0000:0000:FF00:FE00:0000</DOCSIS-
```

```

CMTS:CmtsIpv6Addr>
<DOCSIS-CMTS:CmtsMdIfName>Int0/1</DOCSIS-CMTS:CmtsMdIfName>
<DOCSIS-CMTS:CmtsMdIfIndex>456</DOCSIS-CMTS:CmtsMdIfIndex>
<DOCSIS-CM:CmMacAddr>00-09-36-A7-70-89</DOCSIS-CM:CmMacAddr>
<DOCSIS-CM:CmIpv4Addr>55.12.48.113</DOCSIS-CM:CmIpv4Addr>
<DOCSIS-CM:CmIpv6Addr>2001:0400:0000:0000:0000:1000:FF00:0000</DOCSIS-CM:CmIpv6Addr>
<DOCSIS-CM:CmIpv6LinkLocalAddr>FE80:0000:0000:0000:0209:36FF:FEA7:7089</DOCSIS-
CM:CmIpv6LinkLocalAddr>
<DOCSIS-CM:CmQosVersion>2</DOCSIS-CM:CmQosVersion>
<DOCSIS-CM:CmRegStatusValue>8</DOCSIS-CM:CmRegStatusValue>
<DOCSIS-CM:CmLastRegTime>2006-06-04T09:15:00Z</DOCSIS-CM:CmLastRegTime>
<DOCSIS-REC:RecType>1</DOCSIS-REC:RecType>
<DOCSIS-REC:RecCreationTime>2004-11-10T07:11:05Z</DOCSIS-REC:RecCreationTime>
<DOCSIS-QOS:ServiceFlowChSet>01020304</DOCSIS-QOS:ServiceFlowChSet>
<DOCSIS-QOS:ServiceAppId>10000</DOCSIS-QOS:ServiceAppId>
<DOCSIS-QOS:ServiceDsMulticast>>false</DOCSIS-QOS:ServiceDsMulticast>
<DOCSIS-QOS:ServiceIdentifier>361</DOCSIS-QOS:ServiceIdentifier>
<DOCSIS-QOS:ServiceGateId>500</DOCSIS-QOS:ServiceGateId>
<DOCSIS-QOS:ServiceClassName>Premium</DOCSIS-QOS:ServiceClassName>
<DOCSIS-QOS:ServiceDirection>2</DOCSIS-QOS:ServiceDirection>
<DOCSIS-QOS:ServiceOctetsPassed>16486400</DOCSIS-QOS:ServiceOctetsPassed>
<DOCSIS-QOS:ServicePktsPassed>82431</DOCSIS-QOS:ServicePktsPassed>
<DOCSIS-QOS:ServiceSlaDropPkts>412</DOCSIS-QOS:ServiceSlaDropPkts>
<DOCSIS-QOS:ServiceSlaDelayPkts>8</DOCSIS-QOS:ServiceSlaDelayPkts>
<DOCSIS-QOS:ServiceTimeCreated>2210822</DOCSIS-QOS:ServiceTimeCreated>
<DOCSIS-QOS:ServiceTimeActive>161</DOCSIS-QOS:ServiceTimeActive>
</ipdr:IPDR>
<ipdr:IPDRDoc.End count="1" endTime="2004-11-10T07:11:08Z"/>
</ipdr:IPDRDoc>

```

### V.11.3 SAMIS Type 2 Instance Document

```

<?xml version='1.0' ?>
<ipdr:IPDRDoc xmlns:xsi="http://www.w3.org/2001/XMLSchema-instance"
  xmlns:ipdr="http://www.ipdr.org/namespaces/ipdr"
  xmlns="http://www.cablelabs.com/namespaces/DOCSIS/3.0/xsd/ipdr/DOCSIS-SAMIS-TYPE-2"
  xmlns:DOCSIS-QOS="http://www.cablelabs.com/namespaces/DOCSIS/3.0/xsd/ipdr/DOCSIS-QOS"
  xmlns:DOCSIS-CMTS="http://www.cablelabs.com/namespaces/DOCSIS/3.0/xsd/ipdr/DOCSIS-
CMTS"
  xmlns:DOCSIS-CM="http://www.cablelabs.com/namespaces/DOCSIS/3.0/xsd/ipdr/DOCSIS-CM"
  xmlns:DOCSIS-REC="http://www.cablelabs.com/namespaces/DOCSIS/3.0/xsd/ipdr/DOCSIS-REC"
  xsi:schemaLocation="http://www.cablelabs.com/namespaces/DOCSIS/3.0/xsd/ipdr/DOCSIS-
SAMIS-TYPE-2
  http://www.cablelabs.com/namespaces/DOCSIS/3.0/xsd/ipdr/DOCSIS-SAMIS-TYPE-2/DOCSIS-
SAMIS-TYPE-2_3.5.1-A.1.xsd"
  docId="3d07ba27-0000-0000-0000-1a2b3c4d5e6f"
  version="3.5.1-A.1"
  creationTime="2004-11-10T07:11:05Z"
  IPDRRecorderInfo="cmts01.mso.com">
<ipdr:IPDR xsi:type="SAMIS-TYPE-2">
<DOCSIS-CMTS:CmtsHostName>cmts01.mso.com.</DOCSIS-CMTS:CmtsHostName>
<DOCSIS-CMTS:CmtsSysUpTime>2226878</DOCSIS-CMTS:CmtsSysUpTime>
<DOCSIS-CMTS:CmtsMdIfName>Int0/1</DOCSIS-CMTS:CmtsMdIfName>
<DOCSIS-CMTS:CmtsMdIfIndex>456</DOCSIS-CMTS:CmtsMdIfIndex>
<DOCSIS-CM:CmMacAddr>00-09-36-A7-70-89</DOCSIS-CM:CmMacAddr>
<DOCSIS-REC:RecType>1</DOCSIS-REC:RecType>
<DOCSIS-REC:RecCreationTime>2004-11-10T07:11:05Z</DOCSIS-REC:RecCreationTime>
<DOCSIS-QOS:ServiceFlowChSet>01020304</DOCSIS-QOS:ServiceFlowChSet>
<DOCSIS-QOS:ServiceAppId>10000</DOCSIS-QOS:ServiceAppId>
<DOCSIS-QOS:ServiceDsMulticast>>false</DOCSIS-QOS:ServiceDsMulticast>
<DOCSIS-QOS:ServiceIdentifier>361</DOCSIS-QOS:ServiceIdentifier>
<DOCSIS-QOS:ServiceGateId>500</DOCSIS-QOS:ServiceGateId>
<DOCSIS-QOS:ServiceClassName>Premium</DOCSIS-QOS:ServiceClassName>
<DOCSIS-QOS:ServiceDirection>2</DOCSIS-QOS:ServiceDirection>
<DOCSIS-QOS:ServiceOctetsPassed>16486400</DOCSIS-QOS:ServiceOctetsPassed>
<DOCSIS-QOS:ServicePktsPassed>82431</DOCSIS-QOS:ServicePktsPassed>
<DOCSIS-QOS:ServiceSlaDropPkts>412</DOCSIS-QOS:ServiceSlaDropPkts>
<DOCSIS-QOS:ServiceSlaDelayPkts>8</DOCSIS-QOS:ServiceSlaDelayPkts>
<DOCSIS-QOS:ServiceTimeCreated>2210822</DOCSIS-QOS:ServiceTimeCreated>
<DOCSIS-QOS:ServiceTimeActive>161</DOCSIS-QOS:ServiceTimeActive>
</ipdr:IPDR>

```



```
<ipdr:IPDRDoc.End count="1" endTime="2004-11-10T07:11:08Z"/>
</ipdr:IPDRDoc>
```

## V.12 CMTS-US-UTIL-STATS-TYPE

This section provides a sample XML Instance Document for the CMTS Upstream Utilization Statistics Service Definition, CMTS-US-UTIL-STATS-TYPE and corresponding XML Schema DOCSIS-CMTS-US-UTIL-STATS-TYPE\_3.5.1-A.4.xsd.

### V.12.1 Use Case

At a CMTS sysUpTime of "2226878", the CMTS "cmts01.mso.com" with MAC Domain ifIndex of "456", streams (using an event based session) the upstream utilization statistics information for the upstream logical channel with ifIndex of "17". In addition, the UsUtilInterval of "900" (15 minutes) and the following utilization information is included in the record:

```
IndexPercentage = 80
TotalMslots = 1403854841
UcastGrantedMslots = 33281121
TotalCntnMslots = 1370280369
UsedCntnMslots = 815830
CollCntnMslots = 1332
TotalCntnReqMslots = 311083615
UsedCntnReqMslots = 574833
CollCntnReqMslots = 1332
TotalCntnReqDataMslots = 0
UsedCntnReqDataMslots = 0
CollCntnReqDataMslots = 0
TotalCntnInitMaintMslots = 1059212846
UsedCntnInitMaintMslots = 240997
CollCntnInitMaintMslots = 0
```

### V.12.2 Instance Document

```
<?xml version="1.0"?>
<ipdr:IPDRDoc xmlns:ipdr="http://www.ipdr.org/namespaces/ipdr"
  xmlns:xsi="http://www.w3.org/2001/XMLSchema-instance"
  xmlns="http://www.cablelabs.com/namespaces/DOCSIS/3.0/xsd/ipdr/DOCSIS-CMTS-US-UTIL-
STATS-TYPE"
  xmlns:DOCSIS-CMTS="http://www.cablelabs.com/namespaces/DOCSIS/3.0/xsd/ipdr/DOCSIS-CMTS-
  xmlns: DOCSIS-CMTS-US-
UTIL="http://www.cablelabs.com/namespaces/DOCSIS/3.0/xsd/ipdr/DOCSIS-CMTS-US-UTIL"
  xmlns:DOCSIS-REC="http://www.cablelabs.com/namespaces/DOCSIS/3.0/xsd/ipdr/DOCSIS-REC"
  xsi:schemaLocation="http://www.cablelabs.com/namespaces/DOCSIS/3.0/xsd/ipdr/DOCSIS-CMTS-
US-UTIL-STATS-TYPE
  http://www.cablelabs.com/namespaces/DOCSIS/3.0/xsd/ipdr/DOCSIS-CMTS-US-UTIL-STATS-
TYPE/DOCSIS-CMTS-US-UTIL-STATS-TYPE_3.5.1-A.4.xsd"
  docId="3d07ba27-0000-0000-0000-1a2b3c4d5e6f"
  creationTime="2006-06-05T07:11:00Z"
  IPDRRecorderInfo="cmts01.mso.com"
  version="3.5.1-A.4">
<ipdr:IPDR xsi:type="CMTS-US-UTIL-STATS-TYPE">
  <DOCSIS-CMTS:CmtsHostName>cmts01.mso.com</DOCSIS-CMTS:CmtsHostName>
  <DOCSIS-CMTS:CmtsSysUpTime>2226878</DOCSIS-CMTS:CmtsSysUpTime>
```

```

<DOCSIS-CMTS:CmtsMdIfIndex>456</DOCSIS-CMTS:CmtsMdIfIndex>
<DOCSIS-CMTS-US-UTIL:UsIfIndex>17</DOCSIS-CMTS-US-UTIL:UsIfIndex>
<DOCSIS-CMTS-US-UTIL:UsIfName> Int/0/1/4</DOCSIS-CMTS-US-UTIL:UsIfName>
<DOCSIS-CMTS-US-UTIL:UsChId>2</DOCSIS-CMTS-US-UTIL:UsChId>
<DOCSIS-CMTS-US-UTIL:UsUtilInterval>900</DOCSIS-CMTS-US-UTIL:UsUtilInterval>
<DOCSIS-CMTS-US-UTIL:UsUtilIndexPercentage>80</DOCSIS-CMTS-US-
UTIL:UsUtilIndexPercentage>
<DOCSIS-CMTS-US-UTIL:UsUtilTotalMslots >1403854841</DOCSIS-CMTS-US-
UTIL:UsUtilTotalMslots>
<DOCSIS-CMTS-US-UTIL:UsUtilUcastGrantedMslots>33281121</DOCSIS-CMTS-US-
UTIL:UsUtilUcastGrantedMslots>
<DOCSIS-CMTS-US-UTIL:UsUtilTotalCntnMslots>1370280369</DOCSIS-CMTS-US-
UTIL:UsUtilTotalCntnMslots>
<DOCSIS-CMTS-US-UTIL:UsUtilUsedCntnMslots>815830</DOCSIS-CMTS-US-
UTIL:UsUtilUsedCntnMslots>
<DOCSIS-CMTS-US-UTIL:UsUtilCollCntnMslots>1332</DOCSIS-CMTS-US-
UTIL:UsUtilCollCntnMslots>
<DOCSIS-CMTS-US-UTIL:UsUtilTotalCntnReqMslots>311083615</DOCSIS-CMTS-US-
UTIL:UsUtilTotalCntnReqMslots>
<DOCSIS-CMTS-US-UTIL:UsUtilUsedCntnReqMslots>574833</DOCSIS-CMTS-US-
UTIL:UsUtilUsedCntnReqMslots>
<DOCSIS-CMTS-US-UTIL:UsUtilCollCntnReqMslots>1332</DOCSIS-CMTS-US-
UTIL:UsUtilCollCntnReqMslots>
<DOCSIS-CMTS-US-UTIL:UsUtilTotalCntnReqDataMslots>0</DOCSIS-CMTS-US-
UTIL:UsUtilTotalCntnReqDataMslots>
<DOCSIS-CMTS-US-UTIL:UsUtilUsedCntnReqDataMslots>0</DOCSIS-CMTS-US-
UTIL:UsUtilUsedCntnReqDataMslots>
<DOCSIS-CMTS-US-UTIL:UsUtilCollCntnReqDataMslots>0</DOCSIS-CMTS-US-
UTIL:UsUtilCollCntnReqDataMslots>
<DOCSIS-CMTS-US-UTIL:UsUtilTotalCntnInitMaintMslots>1059212846</DOCSIS-CMTS-US-
UTIL:UsUtilTotalCntnInitMaintMslots>
<DOCSIS-CMTS-US-UTIL:UsUtilUsedCntnInitMaintMslots>240997</DOCSIS-CMTS-US-
UTIL:UsUtilUsedCntnInitMaintMslots>
<DOCSIS-CMTS-US-UTIL:UsUtilCollCntnInitMaintMslots>0</DOCSIS-CMTS-US-
UTIL:UsUtilCollCntnInitMaintMslots>
<DOCSIS-REC:RecType>4</DOCSIS-REC:RecType>
</ipdr:IPDR>
<ipdr:IPDRDoc.End count="1" endTime="2006-06-05T07:15:00Z"/>
</ipdr:IPDRDoc>

```

## V.13 CMTS-DS-UTIL-STATS-TYPE

This section provides a sample XML Instance Document for the CMTS Downstream Utilization Statistics Service Definition, CMTS-DS-UTIL-STATS-TYPE and corresponding XML Schema DOCSIS-CMTS-DS-UTIL-STATS-TYPE\_3.5.1-A.3.xsd.

### V.13.1 Use Case

At a CMTS sysUpTime of "2226888", the CMTS "cmts01.mso.com" with MAC Domain ifIndex of "456", streams (using an event based session) the downstream utilization statistics information for the downstream channel with ifIndex of "18". In addition, the DsUtilInterval of "900" (15 minutes) and the following utilization information is included in the record:

IndexPercentage = 70

TotalBytes = 2668756233

UsedBytes = 3323829507

### V.13.2 Instance Document

```

<?xml version="1.0"?>
<ipdr:IPDRDoc xmlns:ipdr="http://www.ipdr.org/namespaces/ipdr"
  xmlns:xsi="http://www.w3.org/2001/XMLSchema-instance"
  xmlns="http://www.cablelabs.com/namespaces/DOCSIS/3.0/xsd/ipdr/DOCSIS-CMTS-DS-UTIL-
STATS-TYPE"
  xmlns:DOCSIS-CMTS="http://www.cablelabs.com/namespaces/DOCSIS/3.0/xsd/ipdr/DOCSIS-CMTS"

```

```

    xmlns: DOCSIS-CMTS-DS-
UTIL="http://www.cablelabs.com/namespaces/DOCSIS/3.0/xsd/ipdr/DOCSIS-CMTS-DS-UTIL"
    xmlns:DOCSIS-REC="http://www.cablelabs.com/namespaces/DOCSIS/3.0/xsd/ipdr/DOCSIS-REC"
    xsi:schemaLocation="http://www.cablelabs.com/namespaces/DOCSIS/3.0/xsd/ipdr/DOCSIS-CMTS-
DS-UTIL-STATS-TYPE
    http://www.cablelabs.com/namespaces/DOCSIS/3.0/xsd/ipdr/DOCSIS-CMTS-DS-UTIL-STATS-
TYPE/DOCSIS-CMTS-DS-UTIL-STATS-TYPE_3.5.1-A.3.xsd"
    docId="3d07ba27-0000-0000-0000-1a2b3c4d5e6f"
    creationTime="2006-06-05T07:11:00Z"
    IPDRRecorderInfo="cmts01.mso.com"
    version="3.5.1-A.3">
<ipdr:IPDR xsi:type="CMTS-DS-UTIL-STATS-TYPE">
  <DOCSIS-CMTS:CmtsHostName>cmts01.mso.com</DOCSIS-CMTS:CmtsHostName>
  <DOCSIS-CMTS:CmtsSysUpTime>2226888</DOCSIS-CMTS:CmtsSysUpTime>
  <DOCSIS-CMTS:CmtsMdIfIndex>456</DOCSIS-CMTS:CmtsMdIfIndex>
  <DOCSIS-CMTS-DS-UTIL:DsIfIndex>18</DOCSIS-CMTS-DS-UTIL:DsIfIndex>
  <DOCSIS-CMTS-DS-UTIL:DsIfName> Int/0/1/1</DOCSIS-CMTS-DS-UTIL:DsIfName>
  <DOCSIS-CMTS-DS-UTIL:DsChId>1</DOCSIS-CMTS-DS-UTIL:DsChId>
  <DOCSIS-CMTS-DS-UTIL:DsUtilInterval>900</DOCSIS-CMTS-DS-UTIL:DsUtilInterval>
  <DOCSIS-CMTS-DS-UTIL:DsUtilIndexPercentage>70</DOCSIS-CMTS-DS-
UTIL:DsUtilIndexPercentage>
  <DOCSIS-CMTS-DS-UTIL:DsUtilTotalBytes >2668756233</DOCSIS-CMTS-DS-
UTIL:DsUtilTotalBytes>
  <DOCSIS-CMTS-DS-UTIL:DsUtilUsedBytes>3323829507</DOCSIS-CMTS-DS-
UTIL:DsUtilUsedBytes>
  <DOCSIS-REC:RecType>4</DOCSIS-REC:RecType>
  </ipdr:IPDR>
  <ipdr:IPDRDoc.End count="1" endTime="2006-06-05T07:15:00Z"/>
</ipdr:IPDRDoc>

```

## V.14 CMTS-CM-SERVICE-FLOW-TYPE<sup>247</sup>

This section provides a sample XML Instance Document for the CMTS CM Service Flow Service Definition, CMTS-CM-SERVICE-FLOW-TYPE and corresponding XML Schema DOCSIS-CMTS-CM-SERVICE-FLOW-TYPE\_3.5.1-B.1.xsd.

### V.14.1 Use Case

At a CMTS sysUpTime of "2226888", the CMTS "cmts01.mso.com" with MAC Domain ifIndex of "456" and Service Identifier 361, streams (using an event based session) the Service Flow information. The Service Flow is a statically provisioned Best Effort Service Flow. The Service Flow has the following characteristics:

Service Flow Channel Set = 01020304

MaxRate = 1000000

MaxBurst = 2000000

Peak Rate = 3000000

Service Priority = 2

Service Class Name = premium\_up

### V.14.2 Instance Document

```

<?xml version='1.0' ?>
<ipdr:IPDRDoc xmlns:xsi="http://www.w3.org/2001/XMLSchema-instance"
  xmlns:ipdr="http://www.ipdr.org/namespaces/ipdr"
  xmlns="http://www.cablelabs.com/namespaces/DOCSIS/3.1/xsd/ipdr/DOCSIS-CMTS-CM-SERVICE-
FLOW-TYPE"
  xmlns:DOCSIS-QOS="http://www.cablelabs.com/namespaces/DOCSIS/3.0/xsd/ipdr/DOCSIS-QOS"
  xmlns:DOCSIS-CMTS="http://www.cablelabs.com/namespaces/DOCSIS/3.0/xsd/ipdr/DOCSIS-
CMTS"
  xmlns:DOCSIS-REC="http://www.cablelabs.com/namespaces/DOCSIS/3.0/xsd/ipdr/DOCSIS-REC"

```

<sup>247</sup> Modified per CCAP-OSSiv3.1-N-15.1390-2 on 11/11/15 by KB.

```

      xsi:schemaLocation="http://www.cablelabs.com/namespaces/DOCSIS/3.1/xsd/ipdr/DOCSIS-
CMTS-CM-SERVICE-FLOW-TYPE
      http://www.cablelabs.com/namespaces/DOCSIS/3.1/xsd/ipdr/DOCSIS-CMTS-CM-SERVICE-
FLOW-TYPE_3.5.1-B.1.xsd"
      docId="3d07ba27-0000-0000-0000-1a2b3c4d5e6f"
      version="3.5.1-B.1"
      creationTime="2015-11-10T07:11:05Z"
      IPDRRecorderInfo="cmts01.mso.com">
<ipdr:IPDR xsi:type="CMTS-CM-SERVICE-FLOW-TYPE">
  <DOCSIS-CMTS:CmtsHostName>cmts01.mso.com.</DOCSIS-CMTS:CmtsHostName>
  <DOCSIS-CMTS:CmtsSysUpTime>2226878</DOCSIS-CMTS:CmtsSysUpTime>
  <DOCSIS-CMTS:CmtsMdIfName>Int0/1</DOCSIS-CMTS:CmtsMdIfName>
  <DOCSIS-CMTS:CmtsMdIfIndex>456</DOCSIS-CMTS:CmtsMdIfIndex>
  <DOCSIS-REC:RecType>1</DOCSIS-REC:RecType>
  <DOCSIS-REC:RecCreationTime>2004-11-10T07:11:05Z</DOCSIS-REC:RecCreationTime>
  <DOCSIS-QOS:ServiceFlowChSet>01020304</DOCSIS-QOS:ServiceFlowChSet>
  <DOCSIS-QOS:ServiceAppId>10000</DOCSIS-QOS:ServiceAppId>
  <DOCSIS-QOS:ServiceDsMulticast>>false</DOCSIS-QOS:ServiceDsMulticast>
  <DOCSIS-QOS:ServiceIdentifier>361</DOCSIS-QOS:ServiceIdentifier>
  <DOCSIS-QOS:ServiceGateId></DOCSIS-QOS:ServiceGateId>
  <DOCSIS-QOS:ServiceClassName>premium_up</DOCSIS-QOS:ServiceClassName>
  <DOCSIS-QOS:ServiceDirection>2</DOCSIS-QOS:ServiceDirection>
  <DOCSIS-QOS:ServiceTimeCreated>2210822</DOCSIS-QOS:ServiceTimeCreated>
  <DOCSIS-SERVICE-FLOW:ServiceTrafficPriority>2</DOCSIS-SERVICE-
FLOW:ServiceTrafficPriority>
  <DOCSIS-SERVICE-FLOW:ServiceMaxSustained>1000000</DOCSIS-SERVICE-
FLOW:ServiceMaxSustained>
  <DOCSIS-SERVICE-FLOW:ServiceMaxBurst>2000000</DOCSIS-SERVICE-FLOW:ServiceMaxBurst>
  <DOCSIS-SERVICE-FLOW:ServiceMinReservedRate>0</DOCSIS-SERVICE-
FLOW:ServiceMinReservedRate>
  <DOCSIS-SERVICE-FLOW:ServiceIpTos></DOCSIS-SERVICE-FLOW:ServiceIpTos>
  <DOCSIS-SERVICE-FLOW:ServicePeakRate>3000000</DOCSIS-SERVICE-FLOW:ServicePeakRate>
  <DOCSIS-SERVICE-FLOW:ServiceSchedule>2</DOCSIS-SERVICE-FLOW:ServiceSchedule>
  <DOCSIS-SERVICE-FLOW:ServiceNomPollInterval></DOCSIS-SERVICE-FLOW:ServiceNomPollInterval>
  <DOCSIS-SERVICE-FLOW:ServiceTolPollJitter></DOCSIS-SERVICE-FLOW:ServiceTolPollJitter>
  <DOCSIS-SERVICE-FLOW:ServiceUGSize></DOCSIS-SERVICE-FLOW:ServiceUGSize>
  <DOCSIS-SERVICE-FLOW:ServiceNomGrantInterval></DOCSIS-SERVICE-
FLOW:ServiceNomGrantInterval>
  <DOCSIS-SERVICE-FLOW:ServiceTolGrantJitter></DOCSIS-SERVICE-FLOW:ServiceTolGrantJitter>
  <DOCSIS-SERVICE-FLOW:ServiceGrantsPerInterval></DOCSIS-SERVICE-
FLOW:ServiceGrantsPerInterval>
  <DOCSIS-SERVICE-FLOW:ServicePacketClassifier></DOCSIS-SERVICE-
FLOW:ServicePacketClassifier>

  </ipdr:IPDR>
  <ipdr:IPDRDoc.End count="1" endTime="2015-11-10T07:11:08Z"/>
</ipdr:IPDRDoc>

```

## Appendix VI Spectrum Analysis Use Cases (Informative)

This appendix describes several use cases where the Signal Quality Monitoring features introduced in DOCSIS 3.0 can be utilized to manage the HFC plant.

To maintain the HFC network in optimal conditions constant monitoring of the physical characteristics is desired. This practice helps in the early detection of plant problems. These problems, if not properly corrected could cause degradation of services that are offered over the DOCSIS network. The RF impairments may often be the root cause of the problem affecting the quality of services offered over DOCSIS. These impairments result in excessive logging, and poor statistics indicating a lower quality of experience for customer of the services.

Ideally, rather than inferring the presence of RF impairments in the HFC from DOCSIS MAC statistics (for example), the use of Signaling Quality measurement equipment dedicated to monitor the HFC spectrum is desired. However, the cost of such equipment and its associated management and operation may not be justifiable. Instead, active network elements such as CMTSs have evolved their capabilities to report RF measurements using an SNMP management interface. The main advantage of this approach is the constant availability of information across the network. Such information can be correlated to determine e.g., a group of CMs with a common tap in the HFC path reporting the same measurements problem. The signal monitoring approach is similar to how specialized equipment is used to further isolate the problems based on the coarse measurements from a CMTS.

This appendix describes use cases for two main categories of the Enhanced Signaling Quality Monitoring features of DOCSIS 3.0:

- Normalization of RF Impairments Measurements
- Spectrum Amplitude Measurements for Upstream Interfaces

### VI.1 Normalization of RF Impairments Measurements

#### VI.1.1 Problem Description

DOCSIS [RFC 4546] provides SNR (Signal-to-Noise) measurement. SNR among other measurements are available on a per CM basis and per interface.

SNR values reported may not be uniform amongst different CMTS vendors. Therefore it might not be possible to compare and analyze information from different devices to determine the HFC plant conditions.

#### VI.1.2 Use Cases

Major contributors to impairments in the DOCSIS channels are linear distortion, non-linear distortion, impulse noise and ingress noise.

DOCSIS pre-equalization provides a mechanism to correct the linear distortion of each individual CM transmission. Ingress noise robustness has no specification requirements beyond the assumed RF plant conditions in [PHYv3.1]. However, vendors have provided mechanisms to mitigate noise and ingress interference in plants that have more severe noise conditions than the ones assumed in the [PHYv3.1] specification.

The available RF measurements in DOCSIS 3.0 are listed in Table VI-1 where the DOCSIS 3.0 added features are indicated in **bold** text and are the basis for the use cases of this section. In general, downstream RF measurements are performed by individual CMs while the upstream measurements are performed by the CMTS either at an interface or at a CM level. Based on CMTS and CM interactions, the CM provides an indirect measure of the distortion in the upstream channel through its pre-equalization coefficients.

**Table VI-1 - RF Management Statistics available in DOCSIS 3.0**

CM (Downstream Measurements)	CMTS (Upstream Measurements)	Measurements Categories
SNR	SNR	Noise conditions
RxMER	RxMER	
	CNIR	

CM (Downstream Measurements)	CMTS (Upstream Measurements)	Measurements Categories
	Expected Received Power	Power level
Correctable/uncorrectable errors	Correctable/uncorrectable errors per CM	FEC performance statistics
	Correctable/uncorrectable errors per US interface	
Downstream micro-reflections	Upstream micro-reflections per CM	Linear distortion
CM post-equalization data	CM pre-equalization <sup>1</sup>	
<b>Note:</b>		
<sup>1</sup> CM may provide more accurate pre-equalization coefficient than what the CMTS is able to calculate.		

The following use cases refer to the noise measurement enhancements for DOCSIS 3.0.

#### VI.1.2.1 Use Case 1: Figure of Merit Estimation for Logical Upstream Channel

This Use Case defines a Figure of Merit for Logical Upstream Channel measurement that an operator can use to periodically collect information to characterize the performance of the HFC part of the Cable distribution network.

To overcome non-uniform SNR measurements, DOCSIS 3.0 defines two measurements: RxMER (Receive Modulation Error Rate) and CNIR (Carrier to Noise plus Interference Ratio). These provide better indication of the HFC plant impairments and the corrections achieved by the CMTS through compensation techniques. Combining RxMER and CNIR, a Figure of Merit of impairment compensation efficiency can be defined when noise or interference is present.

RxMER measures the average quantization error just prior to FEC, and CNIR measures the carrier to noise plus interference ratio prior to demodulation. A Figure of Merit of how efficiently interference and distortion is compensated in a logical channel can be defined as:

$$\text{Figure of Merit (logical channel)} = \text{RxMER} - \text{CNIR}$$

The variables from Section 6.7.1.2 to retrieve are:

- RxMER: docsIf3SignalQualityExtRxMER
- CNIR: docsIf3CmtsSignalQualityExtCNIR

The Figure of Merit is relevant when the device is capable of suppressing ingressors, thus increasing the RxMER value with respect to the channel CNIR.

To minimize the uncertainties in measuring the Figure of Merit due to distortion that is unique to individual upstream paths between a CM and CMTS, it is advisable to operate with pre-equalization on (see docsIfUpChannelPreEqEnable of [RFC 4546]).

#### VI.1.2.2 Use Case 2 Figure of Merit Estimation per CM

This Use Case defines a Figure of Merit per CM transmission. Similar to Use Case 1, the operator can periodically collect information to characterize the performance of CMs in terms of figure of Merit for the given CMTS the CM is attached to.

Unlike RxMER, the SNR parameter is unique for each CM. This allows you to define a Figure of Merit on a per CM basis. A Figure of Merit of how efficiently interference and distortion affecting a CM is compensated can be defined as:

$$\text{Figure of Merit (CM)} = \text{SNR (CM)} - \text{CNIR (of the logical upstream channel)}$$

The variables from Sections 7.2.2.2 and 6.7.1.2 to retrieve are:

- SNR: docsIf3CmtsCmUsStatusSignalNoise
- CNIR: docsIf3CmtsSignalQualityExtCNIR

This Figure of Merit indicates if a CM, through its pre-equalization mechanism, is efficiently compensating the linear distortion in its upstream path.

### VI.1.2.3 Use Case 3 Absolute Noise and Interference Estimation

Traditionally CMTSs are expected to command the CMs' power transmission so that the CMTS received power is close to 0 dBmV across all CMs.

This Use Case defines how an operator may derive the absolute value of the noise plus interference (in dBmV) from the reported value (CNIR in dB) which is a relative measure.

For example, CNIR and ExpectedRxSignalPower can be used to estimate noise and interference levels (N+I) across the operator's network in dBmV as:

$$N + I = \text{CNIR} - \text{ExpectedRxSignalPower (CMs of the logical upstream channel)}$$

Operators may determine the difference between the target and the actual received power at the CMTS using the following equation:

$$\text{CM Offset Power} = \text{CM Rx Power} - \text{ExpectedRxSignalPower}$$

The variables from Sections 7.2.2.2 and 6.7.1.2 to retrieve are:

- CM Rx Power: docsIf3CmtsCmUsStatusRxPower
- ExpectedRxSignalPower: docsIf3CmtsSignalQualityExtExpectedRxSignalPower

#### VI.1.2.3.1 CM Estimated CNIR

Operators may estimate individual CM CNIR by combining the CNIR obtained for the logical channel and the CM offset power as follows:

$$\text{CM Estimated CNIR} = \text{CM Offset Power} + \text{CNIR}$$

CM Offset Power: The difference between the actual received CM power level and the expected commanded received signal power at the CMTS.

The variables from Sections 7.2.2.2 and 6.7.1.2 to retrieve are:

- CNIR: docsIf3CmtsSignalQualityExtCNIR
- CM Rx Power: docsIf3CmtsCmUsStatusRxPower
- Expected Commanded Received Signal Power: docsIf3CmtsSignalQualityExtExpectedRxSignalPower

## VI.2 Upstream Spectrum Measurement Monitoring

### VI.2.1 Problem Description

Placing spectrum analyzers to obtain granular spectrum monitoring to achieve extensive coverage of the number of nodes, the number of channels, increased frequency of samples, and with increased frequency resolution is cost prohibitive and cumbersome. Such limited coverage complicates agile troubleshooting of plant spectrum.

### VI.2.2 Use Cases

DOCSIS 3.0 adds the spectrum monitoring feature where the management system requests CMTSs to perform spectrum measurement over an upstream channel.

#### VI.2.2.1 Use Case 1 Spectrum Analysis Measurement Setup

This Use Case describes the operator configuration procedure to start the measurements of spectrum amplitude values for a specific channel.

The operator only needs to select the logical upstream channel for which the upstream receiver will capture the spectrum amplitude. SNMP is used to trigger the test using a read-create RowStatus object set to 'CreateAndGo'.

The CMTS reports the following pre-configured parameters (refer to [OSSiv3.0] Annex J for object details):

- The *NumberOfBins* is the number of data points that compose the spectral data.

- The *FrequencySpan* is the width of the band across which the spectral amplitudes characterizing the channel are measured.
- The *ResolutionBW* is the equivalent noise bandwidth for each bin.
- The *TimeInterval* is the estimated average repetition period of measurements defining the average rate at which new spectra can be retrieved. An SNMP manager should not attempt to collect the data at a higher rate than the value specified.
- The *BinSpacing* is the frequency separation between adjacent bin centers.

#### **VI.2.2.2 Use Case 2 Data Retrieval**

This Use Case describes a typical procedure for the retrieval of spectrum amplitude data from the CMTS. The data can be retrieved via SNMP or streamed by the CMTS using the Spectrum Amplitude IPDR Service Definition defined in Section 8.

Section 8 illustrates the detailed steps for the IPDR connection establishment and data retrieval. The following process briefly defines the data retrieval process. Refer to Section 8.2 for details on the IPDR Streaming Protocol.

The collector opens a connection with the CMTS. If a reliable collection mechanism is not required, there is no need to have a backup collector.

The CMTS is configured to generate data for a given interface.

When the CMTS setup is complete, it starts the transfer of information to the collector.

The operator can then use an application to plot the information collected as shown in Figure VI-1 and Figure VI-2.

When the operator no longer wishes to continue retrieving information, the operator can remove the measurement point in the CMTS which suspends the data generation and export. The operator can then tear down the previously established IPDR/SP connection.

The Figure VI-1 shows the sequence diagram for streaming of spectrum analysis measurement data. The operator selects the logical upstream channel of interest. The CMTS starts the data streaming to the collector. After the data is captured, the streaming may be terminated.



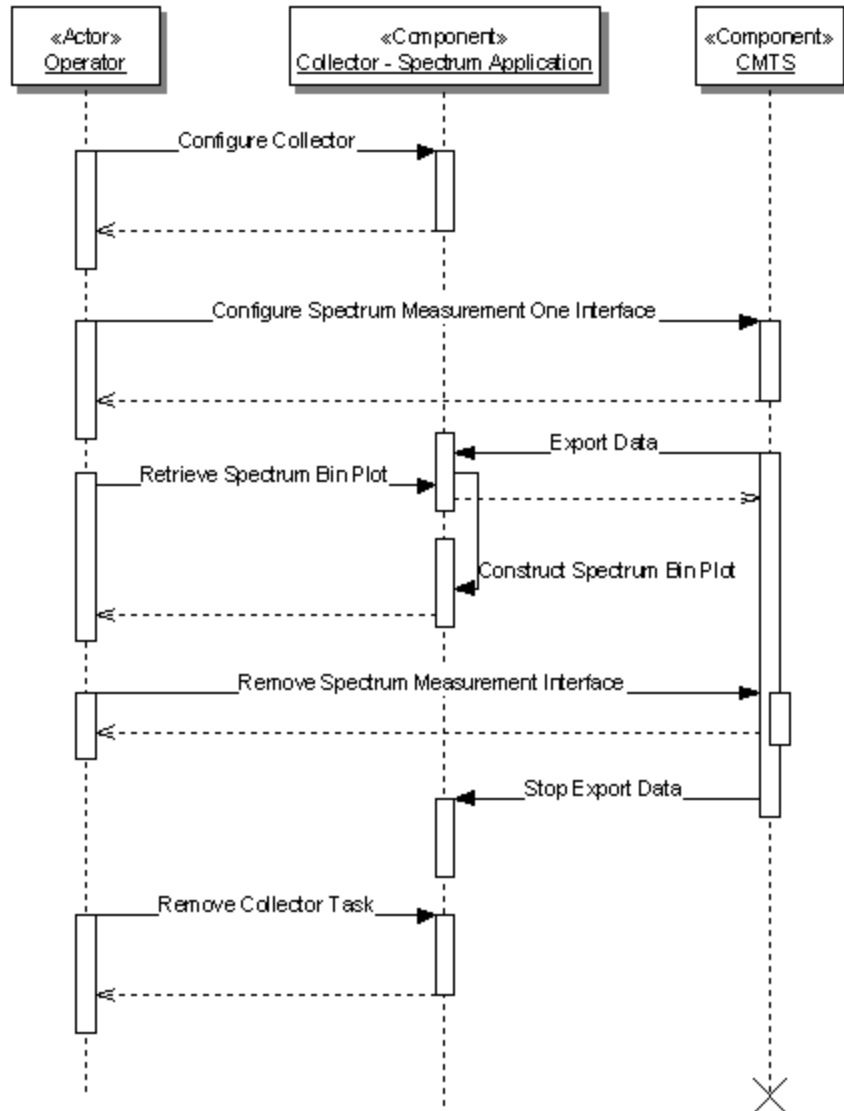

**Figure VI-1 - Sequence Diagram for Streaming of Spectrum Analysis Measurement Data**

**VI.2.2.3 Use Case 3 Data Analysis**

Table VI-2 shows a data point for a given time and plotted in Figure VI-2 and Figure VI-3 as the "current" data series. For this analysis, the following parameters are known from the configuration:

Center Frequency of the channel is 25000000 Hz and is reported in the 129th bin (assuming 257 bins).

Frequency Span is 3200000 Hz (Channel Width)

Bin Spacing is 12500 Hz

From the collected data, the following parameters can be derived:

Frequency of the lower bin is 23400000 Hz

Frequency of the upper bin is 26600000 Hz

Figure VI-2 shows the plotted graph of two data series. The first series "Current" consist of the current spectral content characterized by the frequency bin amplitude values. The second data series is the "Maximum" amplitude

values per frequency bin recorded over time (max hold). Each time a new measurement point is collected the figure is updated. Figure VI-3 zooms around 24 MHz to show the presence of an interferer.

**Table VI-2 - Spectrum Analysis Measurement Constructed Graph from collected data**

First Bin Frequency (For Reference)	Bin Amplitude Values for 8 bins (Decimal)	Bin Amplitude Values for 8 bins (Hexadecimal)
23400000	-39.73 -20.60 -9.23 -4.77 -2.90 -0.08 -0.32 -0.07	F07A F7F4 FC64 FE23 FEDE FFF7 FFDF FFF9
23500000	-0.06 -0.03 -0.08 -0.16 -0.08 0.16 0.13 -0.09	FFFA FFFC FFF8 FFF0 FFF7 000F 000C FFF7
23600000	0.10 0.28 -0.24 -0.02 -0.38 -0.23 -0.01 -0.20	0009 001B FFE8 FFFE FFDA FFE9 FFFE FFEB
23700000	0.08 0.02 0.03 0.04 0.11 0.20 -0.03 0.13	0007 0001 0002 0004 000A 0014 FFFD 000C
23800000	-0.05 0.42 0.11 -0.05 -0.05 -0.36 0.12 -0.06	FFFB 0029 000A FFFB FFFA FFDC 000B FFFA
23900000	-0.07 0.03 -0.13 0.15 -0.17 -0.25 -0.01 -0.13	FFF8 0003 FFF3 000E FFEF FFE6 FFFE FFF3
24000000	-0.09 -0.47 -0.08 0.19 -0.03 0.09 0.13 0.27	FFF7 FFD0 FFF7 0013 FFFD 0009 000D 001A
24100000	0.23 -0.27 0.19 -0.08 0.17 0.11 0.25 0.06	0016 FFE4 0013 FFF7 0010 000A 0019 0005
24200000	0.26 0.00 0.03 -0.08 -0.33 -0.05 0.10 0.08	0019 0000 0003 FFF8 FFDE FFFB 0009 0007
24300000	-0.21 -0.11 0.07 -0.03 8.25 18.67 17.01 0.16	FFEA FFF5 0006 FFFC 0339 074A 06A4 0010
24400000	0.17 0.48 -0.15 0.34 0.40 -0.01 -0.12 0.02	0011 0030 FFF1 0022 0028 FFFE FFF3 0001
24500000	0.01 0.00 -0.08 0.30 -0.04 -0.04 -0.19 -0.01	0001 FFFF FFF7 001D FFFB FFFB FFED FFFF
24600000	0.13 -0.08 -0.07 0.02 0.12 -0.20 0.11 0.25	000D FFF7 FFF9 0002 000B FFEB 000B 0018
24700000	0.04 0.32 -0.11 0.03 0.16 0.06 -0.26 0.28	0004 001F FFF5 0003 000F 0005 FFE6 001B
24800000	-0.05 0.11 0.01 0.14 0.10 0.26 0.34 0.23	FFFB 000A 0000 000E 000A 0019 0022 0017
24900000	-0.18 -0.17 0.15 -0.11 0.08 -0.29 -0.20 0.32	FFED FFEE 000F FFF4 0008 FFE3 FFEC 0020
25000000	-0.10	FFF5
25012500	0.37 0.24 -0.43 -0.24 -0.09 0.23 -0.14 0.19	0025 0018 FFD5 FFE8 FFF7 0017 FFF1 0013
25112500	-0.02 -0.20 0.03 -0.01 -0.12 -0.07 0.24 0.22	FFFD FFEB 0003 FFFE FFF3 FFF8 0017 0015
25212500	-0.17 -0.20 -0.26 0.27 0.42 0.00 -0.08 -0.06	FFEE FFEC FFE6 001A 0029 FFFF FFF7 FFFA
25312500	-0.31 -0.12 0.13 0.02 0.03 0.10 -0.06 -0.30	FFE0 FFF3 000C 0001 0002 000A FFF9 FFE2
25412500	0.35 0.23 0.08 0.19 0.06 0.00 -0.15 0.16	0022 0016 0008 0013 0006 FFFF FFF0 000F
25512500	0.00 0.06 -0.19 0.32 -0.13 0.06 -0.03 -0.10	0000 0006 FFED 001F FFF2 0006 FFFD FFF5
25612500	0.00 0.26 0.09 -0.63 -0.23 0.09 0.38 0.30	0000 0019 0009 FFC1 FFE8 0008 0026 001D
25712500	0.24 -0.03 0.03 -0.01 0.30 0.09 0.05 -0.25	0018 FFFD 0003 FFFE 001D 0009 0004 FFE7
25812500	-0.11 0.29 0.39 -0.24 0.11 -0.01 -0.16 -0.36	FFF5 001C 0027 FFE7 000B FFFF FFF0 FFDC
25912500	-0.31 0.27 0.28 0.53 -0.03 0.08 0.00 0.40	FFE1 001B 001C 0034 FFFD 0008 0000 0027
26012500	0.10 -0.16 -0.13 -0.02 -0.05 -0.05 0.20 0.23	0009 FFF0 FFF2 FFFE FFFA FFFB 0014 0016
26112500	-0.01 -0.01 0.24 0.00 0.06 -0.36 -0.09 -0.02	FFFE FFFE 0018 0000 0006 FFDC FFF6 FFFE
26212500	0.00 0.10 0.15 0.21 0.36 -0.11 0.01 0.13	FFFF 000A 000E 0015 0023 FFF5 0001 000C
26312500	0.11 0.01 -0.07 0.15 0.36 -0.08 0.01 -0.02	000B 0001 FFF9 000E 0024 FFF7 0000 FFFE
26412500	0.35 -0.17 0.16 -0.03 0.03 0.05 0.18 -0.14	0022 FFEF 000F FFFC 0002 0004 0011 FFF2
26512500	0.13 -0.04 0.15 -2.62 -4.54 -10.43 -19.22 -39.43	000D FFFB 000F FEFA FE39 FBED F87E F098

**Table Note:** This first column corresponds to the frequency of the first spectrum amplitude bin value of each row and is for reference only (i.e., not part of the reported data array). The decimal representation of the reported data array is shown in the second column. The hexadecimal representation of the reported data array is shown in the third column. Each data point is delimited with a single space for readability.

### Spectrum Amplitude CMTS X Interface Y

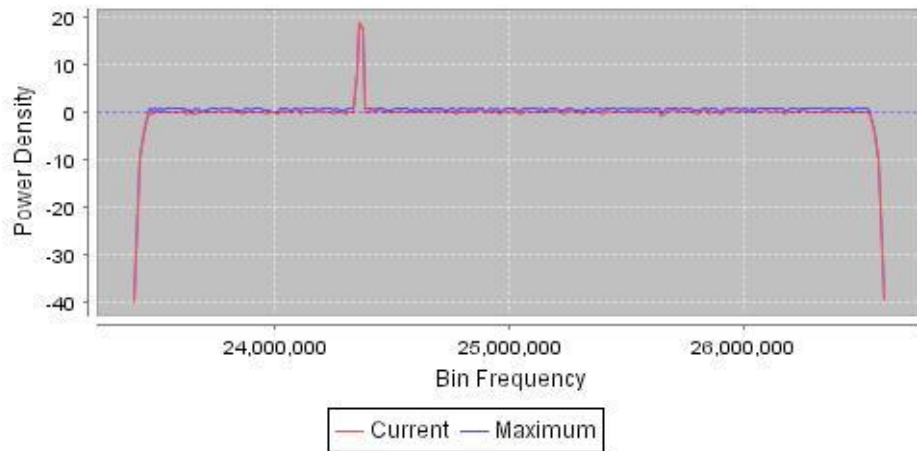

Figure VI-2 - Spectrum Amplitude Constructed Graph from Collected Data

### Spectrum Amplitude CMTS X Interface Y

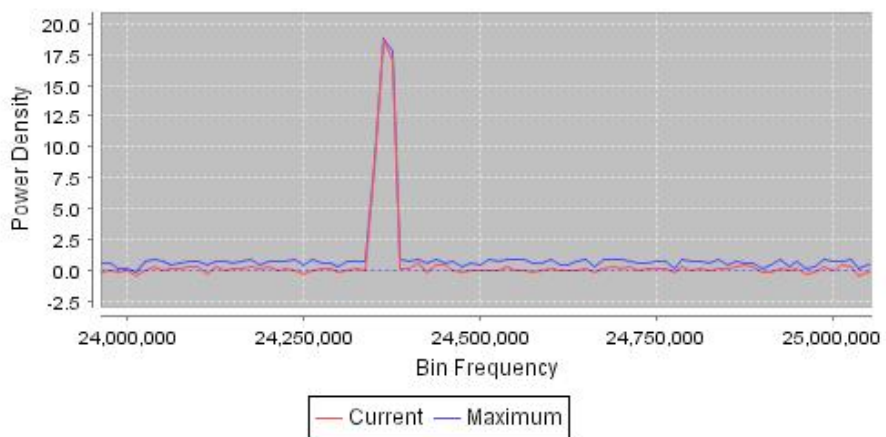

Figure VI-3 - Spectrum Amplitude Detail Graph from Collected Data

## Appendix VII Information Model Notation (Informative)

This appendix illustrates the UML notation used throughout this specification to define Information Models.

### VII.1 Overview

The Unified Modeling Language (UML) is a unified model for object oriented analysis and design (OOA&D). UML is an OMG standard and is an accepted ISO specification [ISO 19501].

UML defines a general-purpose, graphical modeling language that can be applied to any application domain (e.g., communications) and implementation platforms (e.g., J2EE).

### VII.2 Information Model Diagram

The OSSI Information Model diagram is represented by the UML Class Diagram. The class diagram describes the types of objects existing in a system and their static relationship or association.

#### VII.2.1 Classes

Classes are generally represented by a square box with three compartments. The top compartment contains the class name (used here as the object name) with the first letter capitalized. The middle compartment contains the list of attributes with the first letter of each attribute in lower case. The bottom compartment contains the list of operations. For the purposes of this specification, the methods section of the class box is not used (suppressed) and the implementation level details of the attributes are omitted.

Attributes also include a visibility notation which precedes the attribute name and is one of the following:

- '+' public (default)
- '-' private
- '#' protected

If the above notation is omitted from the attribute, the default of public is implied. For the purposes of this specification, the protected visibility generally refers to indexes of MIB tables, schema instances, etc.

An interface is represented in the class diagram as an object with the keyword <<interface>> preceding the object name. In general, an interface is a declaration of a set of public features and obligations (such as get methods).

#### VII.2.2 Associations

A class diagram also contains associations which represent relationships between instances of classes. An association has two ends with each end attached to one of the classes. The association end also has a multiplicity indicator which defines how many objects may participate in the relationship. Multiplicity notation is as follows:

- '1' exactly one
- '\*' zero or more (default)
- '0..1' zero or one (optional)
- 'm..n' numerically specified

If the above notation is omitted from the association end, the default of '\*' is implied.

If one end of the association contains an open arrowhead, this implies navigability in the direction indicated by the arrow.

#### VII.2.3 Generalization

Generalization is the concept of creating subclasses from superclasses and is also known as inheritance within programming languages. Subclasses include (or inherit) all the elements of the superclass and may override inherited methods. Subclasses are more specific classes while superclasses are generalized classes.

The UML notation for Generalization is shown as a line with a hollow triangle as an arrowhead pointing to the generalized class.

**VII.2.4 Dependencies**

Dependencies between two classes are represented by a dashed arrow between two objects. The object at the tail of the arrow depends on the object at the other end.

**VII.2.5 Comment**

A Comment in a class diagram is a textual annotation attached to any element. This is represented as a note symbol with a dashed line connecting the note with the element.

**VII.2.6 Diagram Notation**

Figure VII-1 highlights the UML Class Diagram notation discussed in this section.

Figure VII-1 is not a complete representation of the UML Class Diagram notation, but captures those concepts used throughout this specification.

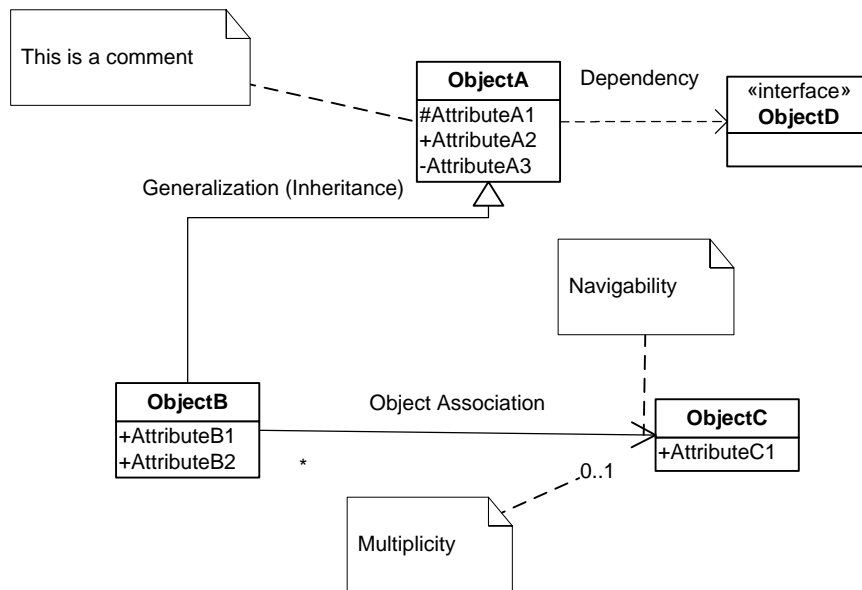
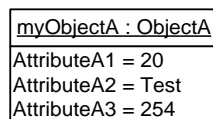

**Figure VII-1 - Object Model UML Class Diagram Notation**

**VII.3 Object Instance Diagram**

An Object Instance Diagram represents the objects in a system during one snapshot in time. In this diagram, the class objects are instantiated.

Figure VI-2 shows an Object Instance Diagram for an instantiation (myObjectA) of ObjectA from Figure VII-1.



**Figure VII-2 - Object Instance Diagram for ObjectA**

## VII.4 ObjectA Definition Example

This section defines the details of the object and its associated attributes as defined in the object model diagram. The description of the object includes behavior, persistence requirements (if any), object creation and deletion behavior (if any), etc.

Table VII-1 lists the attributes the object defined in the object model. The object table is derived from the object model diagram where each row in the table represents an attribute of the object.

The "Attribute Name" column contains each defined attribute of the object. The naming convention for attributes is to capitalize the first letter and each letter of successive words within the name. Also, attribute names typically do not include any of the object name elements since this would cause duplication when the object and attributes are realized in SNMP.

The "Type" column contains the data type for the attribute. The data type can be a simple type such as unsignedInt or a defined data type such as EnumBits. DOCSIS 3.0 data types are defined in Annex F.

The "Access" column indicates the attributes accessibility (as mapped to an SNMP object for example). Example values include "key", "read-only", "read-write", and "read-create".

The "Type Constraints" column lists constraints on the normal data type specified in the "Type" column. If there are no defined constraints for the attribute, this column is empty. The example below for AttributeA1 lists a constraint on the unsignedInt Type where the range starts from 1 instead of normally starting from 0 for an unsignedInt.

The "Units" column lists units for the attribute or "N/A" if the attribute does not have units.

The "Default" column contains the default value for the attribute or "N/A" if the attribute does not have a default value or in cases where the attribute's description defines rules for the initialization value.

The sections following the table are attribute descriptions which might include behavioral requirements or references.

**Table VII-1 - ObjectA Example Table Layout**

Attribute Name	Type	Access	Type Constraints	Units	Default
AttributeA1	unsignedInt	key	1..4294967295	N/A	N/A
AttributeA2	AdminString	read-write	SIZE (1..15)	N/A	N/A
AttributeA3	unsignedByte	read-create		seconds	60

### VII.4.1.1 AttributeA1

AttributeA1 is a key defined for...

**NOTE:** Objects which represent a table (in an SNMP MIB realization) and have N number of instances need to include at least one "key" attribute which is used to denote the instance or id. Key attributes are typically denoted with a protected visibility whereas all other attributes are denoted with a public visibility.

### VII.4.1.2 AttributeA2

AttributeA2 is ...

**NOTE:** Persistence requirements are documented at the object level, not at the attribute level.

### VII.4.1.3 AttributeA3

AttributeA3 is ...

## VII.5 Common Terms Shortened

The following table lists common terms which have been shortened to allow shorter SNMP MIB names. These shortened names are desired to be used consistently throughout the object models, SNMP MIBs and IPDR schemas. However, in some cases it might not be possible to maintain parity with pre-3.0 DOCSIS requirements.

**Table VII-2 - Shortened Common Terms**

Original Word	Shortened Word
Address	Addr
Aggregate	Agg
Algorithm	Alg
Application	App
Attribute	Attr
Authorization	Auth
Channel	Ch
Command	Cmd
Config*	Cfg
Control	Ctrl
Default	Def
Destination	Dest
Direction	Dir
Downstream	Ds
Encryption	Encrypt
Equalization	Eq
Group	Grp
Length	Len
Maximum	Max
Minimum	Min
Multicast	Mcast
Provision*	Prov
Receive	Rx
Registration	Reg
Replication	Repl
Request	Req
Resequence	Reseq
Resequencing	Reseq
Response	Rsp
Segment	Sgmt
Sequence	Seq
Service	Svc
ServiceFlow	Sf
Session(s)	Sess
Source	Src
Threshold	Thrshld
Total	Tot
Transmit	Tx
Upstream	Us
* indicates a wildcard	

### VII.5.1 Exceptions

Data types and managed objects do not consistently use the shortened names. Also, the term ServiceFlowId remains unchanged. Service and ServiceFlow are often not shortened to retain backward compatibility with QoS managed objects.

## Appendix VIII Acknowledgments (Informative)

On behalf of the cable industry and our member companies, CableLabs would like to thank the following individuals for their contributions to the development of this specification.

<b>Contributor</b>	<b>Company Affiliation</b>
Mark Lynch	Arris
Dan Torbet	Arris
Bruce Currivan	Broadcom
Roger Fish	Broadcom
Thomas Clack	Broadcom
Niem Dang	Time Warner Cable
Kirk Erichsen	Time Warner Cable
Miguel Alvarez	CableLabs
Brian Hedstrom	OAM Technology Consulting
Kevin Luehrs	CableLabs
Pawel Sowinski	Cisco
Dan Hegglin	Cisco
Joe Solomon	Comcast
John Bevilacqua	Comcast
Larry Wolcott	Comcast
Andrew Sundelin	Dial in the Sun, LLC
Tom Staniec	GainSpeed
Hesham ElBakoury	Huawei
Satish Mudugere	Intel
Mukul Joshi	ST Micro



## Appendix IX Revision History

The following Engineering Change was incorporated into CM-SP-CCAP-OSSv3.1-I02-141120.

ECN Identifier	Accepted Date	Title of EC	Author
CCAP-OSSv3.1-N-14.1199-3	11/5/2014	Omnibus Editorial EC for CCAP-OSSv3.1	Alvarez

The following Engineering Changes were incorporated into CM-SP-CCAP-OSSv3.1-I03-150326.

ECN Identifier	Accepted Date	Title of EC	Author
CCAP-OSSv3.1-N-14.1225-1	1/7/2015	Section 9 updates and annex addition	Alvarez
CCAP-OSSv3.1-N-14.1229-1	1/21/2015	Update SubcarrierZeroFreq definition text for CCAP	Alvarez
CCAP-OSSv3.1-N-15.1237-1	2/18/2015	Update Sample CCAP Configuration XML	Lynch
CCAP-OSSv3.1-N-15.1246-2	2/25/2015	CCAP OFDMA Status Updates	Sundelin
CCAP-OSSv3.1-N-15.1248-1	2/25/2015	SECv3.1 ref updates in CCAP-OSSv3.1	Tayal
CCAP-OSSv3.1-N-15.1249-3	2/25/2015	CCAP IF-MIB Changes	Sundelin
CCAP-OSSv3.1-N-15.1250-2	2/25/2015	CCAP PNM Update	Clack
CCAP-OSSv3.1-N-15.1255-1	2/25/2015	DOCS-SUBMGT3-MIB Figure Caption Update	Alvarez
CCAP-OSSv3.1-N-15.1256-1	2/25/2015	Add text for DataRateUnitSetting parameter	Alvarez
CCAP-OSSv3.1-N-15.1258-2	2/25/2015	MAC Domain and US Interface Config Updates	Alvarez
CCAP-OSSv3.1-N-15.1259-1	2/25/2015	Downstream OFDM Updates	Sundelin

The following Engineering Changes were incorporated into CM-SP-CCAP-OSSv3.1-I04-150611.

ECN Identifier	Accepted Date	Title of EC	Author
CCAP-OSSv3.1-N-15.1238-2	3/18/2015	DOCSIS 3.1 CCAP YANG	Lynch
CCAP-OSSv3.1-N-15.1276-1	3/25/2015	XML Schema for 3.1 CCAP	Alvarez
CCAP-OSSv3.1-N-15.1278-4	4/8/2015	New DOCSIS 3.1 MIB	Alvarez
CCAP-OSSv3.1-N-15.1307-3	5/13/2015	Omnibus EC for CCAP I04 Candidate	Alvarez

The following Engineering Changes were incorporated into CM-SP-CCAP-OSSv3.1-I05-150910.

ECN Identifier	Accepted Date	Title of EC	Author
CCAP-OSSv3.1-N-15.1308-2	5/20/2015	CCAP-OSSI Updates to the IF31 MIB for I04	Alvarez
CCAP-OSSv3.1-N-15.1321-1	7/15/2015	Changes to SUBMGT3 MIB information	Barringer
CCAP-OSSv3.1-N-15.1322-1	7/15/2015	Delete OFDMA PreEqEnable	Alvarez
CCAP-OSSv3.1-N-15.1323-1	7/15/2015	PartialChannelReasonType	Alvarez
CCAP-OSSv3.1-N-15.1324-1	7/15/2015	IF31 MIB update PartialChanReasonType	Alvarez
CCAP-OSSv3.1-N-15.1325-2	7/15/2015	NCP modulation changes to DsOfdmChannelCfg	Alvarez
CCAP-OSSv3.1-N-15.1335-1	7/29/2015	RCCID and RCPID updates	Alvarez
CCAP-OSSv3.1-N-15.1343-2	8/12/2015	PNM Default File Name Update	Early
CCAP-OSSv3.1-N-15.1344-1	8/12/2015	YANG file updates for I05	Lynch
CCAP-OSSv3.1-N-15.1345-1	8/12/2015	XSD file updates for I05	Lynch
CCAP-OSSv3.1-N-15.1348-1	8/12/2015	CCAP Sample XML Config file	Lynch
CCAP-OSSv3.1-N-15.1349-3	8/12/2015	OSSv3.1 updates for RMI	Solomon

The following Engineering Changes were incorporated into CM-SP-CCAP-OSSv3.1-I06-151210.

ECN Identifier	Accepted Date	Title of EC	Author
CCAP-OSSv3.1-N-15.1364-1	9/16/2015	Clarification of Fixed Point notation for CCAP PNM objects	Fish
CCAP-OSSv3.1-N-15.1373-1	10/7/2015	Incorrect Event ID in requirement - D3.1	Solomon
CCAP-OSSv3.1-N-15.1376-1	10/7/2015	Updates to IF31 MIB for CCAP	Solomon
CCAP-OSSv3.1-N-15.1384-2	10/21/2015	Updates to YANG, XSD, and Sample XML D3.1	Solomon
CCAP-OSSv3.1-N-15.1389-2	11/4/2015	Profile Full Channel Speed Update	Sundelin
CCAP-OSSv3.1-N-15.1390-2	11/4/2015	DOCSIS 3.1 IPDR changes	Sundelin
CCAP-OSSv3.1-N-15.1394-1	11/4/2015	Correction of Minimum Channel Width Numbers	Early

The following Engineering Changes were incorporated into CM-SP-CCAP-OSSv3.1-I07-160602.

ECN Identifier	Accepted Date	Title of EC	Author
CCAP-OSSv3.1-N-15.1417-1	1/27/2016	Updates to the Entity-MIB requirements	Solomon
CCAP-OSSv3.1-N-16.1423-2	2/24/2016	Deprecation of MIB objects in Annex A	Hedstrom
CCAP-OSSv3.1-N-16.1424-1	2/24/2016	Corrections to TimeInterleaverDepth attribute of DsOfdmChannelCfg	Hedstrom
CCAP-OSSv3.1-N-16.1427-1	2/17/2016	Creation of new MULPI CM STATUS events	Hedstrom
CCAP-OSSv3.1-N-16.1430-2	3/10/2016	Clarifications for CmtsCmRegStatus object	Hedstrom
CCAP-OSSv3.1-N-16.1431-1	3/10/2016	Corrections and updates to DOCS-IF3-MIB	Hedstrom
CCAP-OSSv3.1-N-16.1432-3	3/10/2016	Corrections and updates to DOCS-IF31-MIB	Hedstrom
CCAP-OSSv3.1-N-16.1433-1	3/10/2016	Move status/performance objects out of Config Mgt section	Hedstrom
CCAP-OSSv3.1-N-16.1434-1	3/10/2016	Corrections and updates to DOCS-LOADBAL3-MIB	Hedstrom
CCAP-OSSv3.1-N-16.1435-1	3/10/2016	Corrections and updates to DOCS-QOS3-MIB	Hedstrom
CCAP-OSSv3.1-N-16.1439-3	4/7/2016	Updates to OFDMA Upstream Config and Status model	Hedstrom
CCAP-OSSv3.1-N-16.1440-3	4/14/2016	Updates to OFDM Downstream Config and Status model	Hedstrom
CCAP-OSSv3.1-N-16.1447-1	3/31/2016	Remove vague normative requirement	Hedstrom
CCAP-OSSv3.1-N-16.1452-1	4/7/2016	Update TargetRxPower description <b>NOTE:</b> Superseded by ECN 1464-3, Change #2	Luehrs
CCAP-OSSv3.1-N-16.1455-2	5/5/2016	Corrections and updates to DOCS-QOS3-MIB Part 2	Hedstrom
CCAP-OSSv3.1-N-16.1464-3	4/21/2016	Clarification of CCAP upstream received power reporting	Fish
CCAP-OSSv3.1-N-16.1467-2	4/21/2016	Add ifIndex to the profile lists	Solomon
CCAP-OSSv3.1-N-16.1471-3	5/5/2016	OFDM channel lock updates	Hedstrom
CCAP-OSSv3.1-N-16.1472-4	5/5/2016	Corrections and updates to DOCS-IF31-MIB Part 2	Hedstrom
CCAP-OSSv3.1-N-16.1489-3	5/5/2016	Corrections and updates to DOCS-PNM-MIB	Hedstrom
CCAP-OSSv3.1-N-16.1490-2	5/5/2016	Updates for Upstream OFDM PNM Model	Hedstrom
CCAP-OSSv3.1-N-16.1493-1	4/28/2016	Corrections to DsOfdmProfileStats object	Hedstrom
CCAP-OSSv3.1-N-16.1496-2	5/5/2016	PNM Histogram - CCAP	Clack
CCAP-OSSv3.1-N-16.1499-1	5/5/2016	Define events for unsupported SSH Server object Cipher and MAC attributes	Luehrs
CCAP-OSSv3.1-N-16.1505-2	5/5/2016	Updates to DOCS-BPI2EXT-MIB for RPD Cert Management	Hedstrom
CCAP-OSSv3.1-N-16.1506-2	5/5/2016	External Trigger for OPT messages	Torbet
CCAP-OSSv3.1-N-16.1507-1	5/5/2016	Add modem-to-profile assignment count to docsf31CmtsDsOfdmProfileStatsTable	Yan
CCAP-OSSv3.1-N-16.1509-1	5/5/2016	Corrections and updates to DOCS-IF3-MIB Part 2	Hedstrom
CCAP-OSSv3.1-N-16.1510-2	5/5/2016	CCAP - Annex A.1 Updates	Hedstrom

The following Engineering Changes were incorporated into CM-SP-CCAP-OSSv3.1-I08-170111.

ECN Identifier	Accepted Date	Title of EC	Author
CCAP-OSSv3.1-N-16.1517-1	5/26/2016	Removal of PHS attribute from ServiceFlowStats in UML Diagram	Hedstrom
CCAP-OSSv3.1-N-16.1519-1	5/26/2016	Removal of Partial Channel Mode attributes for OFDMA	Hedstrom
CCAP-OSSv3.1-N-16.1522-2	6/2/2016	Align key functional characteristics assumptions of network with DOCSIS 3.0	Hart
CCAP-OSSv3.1-N-16.1528-2	7/7/2016	Addition of IATC Profile Statistics	Hedstrom
CCAP-OSSv3.1-N-16.1533-2	7/7/2016	Additional CCAP events for profile management	Solomon
CCAP-OSSv3.1-N-16.1536-6	8/11/2016	CCAP PNM Upstream Triggered Spectrum Capture update	Luehrs
CCAP-OSSv3.1-N-16.1541-2	7/28/2016	Reversal of ECN 1493	Hedstrom
CCAP-OSSv3.1-N-16.1544-2	7/28/2016	Removal of docsf31CmtsCmDsOfdmProfileTotalCodewords	Hedstrom
CCAP-OSSv3.1-N-16.1546-1	6/30/2016	Add docsfPnmBulk objects to CCAP OSSI Annex A	Luehrs
CCAP-OSSv3.1-N-16.1553-1	7/28/2016	Change US and DS ChannelIds to UnsignedByte	Hedstrom
CCAP-OSSv3.1-N-16.1563-2	8/11/2016	Change of MTU Size for CCAP	Hedstrom
CCAP-OSSv3.1-N-16.1566-1	8/18/2016	Deprecate and replace docsfDocsisBaseCapability	Hedstrom
CCAP-OSSv3.1-N-16.1571-1	8/25/2016	Removal of Dynamic Secret from Information Model	Hedstrom
CCAP-OSSv3.1-N-16.1572-1	8/25/2016	Addition of missing IPv6 CM registration Events for the CCAP	Hedstrom
CCAP-OSSv3.1-N-16.1592-1	9/8/2016	Annex A updates for Upstream Spectrum Analysis feature	Hedstrom
CCAP-OSSv3.1-N-16.1609-1	10/20/2016	Deprecate PHS Events	Hedstrom
CCAP-OSSv3.1-N-16.1610-2	10/20/2016	Mixed modulation support status reporting	Sowinski
CCAP-OSSv3.1-N-16.1618-3	11/3/2016	Remove DOCSIS 1.0 Class of Service support	Hedstrom
CCAP-OSSv3.1-N-16.1625-1	10/27/2016	Fix for bug in YANG/XSD for subscriber filters	Hedstrom
CCAP-OSSv3.1-N-16.1631-5	12/8/2016	Update to Impulse Noise and Removal of Truncated TimeStamps	Fish
CCAP-OSSv3.1-N-16.1635-1	11/10/2016	CCAP Remove Normative Keywords from Tables	Hedstrom
CCAP-OSSv3.1-N-16.1640-2	11/17/2016	Modify BPI2Enforce object - Remove CoS Dependencies (D1.0)	Burroughs
CCAP-OSSv3.1-N-16.1643-2	12/1/2016	Organization of Document Section 1.5 missing sections	Hedstrom
CCAP-OSSv3.1-N-16.1645-2	12/1/2016	Remove Inconsistency in Roll Off Period Units	Burroughs
CCAP-OSSv3.1-N-16.1667-3	12/15/2016	Correct videochannel ifType	Burroughs
CCAP-OSSv3.1-N-16.1668-1	12/15/2016	Remove Appendix VIII	Burroughs
CCAP-OSSv3.1-N-16.1684-2	12/15/2016	Clarify CCAP docsf3RxChStatusEntry	Burroughs
CCAP-OSSv3.1-N-16.1686-2	12/15/2016	Add counter of CMs associated with data IUC	Burroughs